

INFINITY®

MASSAGE CHAIR



INFINITY®

72 Start Road, Seabrook, NH 03874
603-910-5000
www.infinitymassagechairs.com

User Manual

DYNASTY

Thank you for purchasing this product. Please read this user manual carefully before using to ensure proper installation and operation.

Please keep this USER MANUAL for further reference.

▶ CONTENTS

SAFETY PRECAUTIONS	1
NAME AND FUNCTION OF EACH COMPONENT	3
External Structure	3
Internal Structure	3
Remote Control	4
Remote Control Instructions	5
Display Screen Menu Instructions	7
FEATURES	16
APP DOWNLOAD AND INSTALLATION	18
PRELIMINARY CHECKS	19
Installation Site	19
Floor Protection	20
Grounding Instructions	20
Initial Assembly	21
Moving Methods	24
Connect to Power	24
Inspections Before Sitting	25
After Use	25
CARE AND MAINTENANCE	26
TROUBLE SHOOTING	27
TECHNICAL SPECIFICATION	28

Below Form Shows the Name and Content of Hazardous Substance for this Product

Parts Name	Restricted Substances					
	Pb	Hg	Cd	Cr	PBB	PBDE
Outer Panels	○	○	○	○	○	○
Circuit Board Assembly	×	○	○	○	○	○
Metal Work	×	○	○	○	○	○
Rubber Piece	○	○	○	○	○	○
Power Cable/ PowerAdapter	×	○	○	○	○	○
Inner Signal Connecting Cable	○	○	○	○	○	○
Upholstery	○	○	○	○	○	○

This form is made under the regulation of SJ/T 11364

※ : Curcuit Board Assemblies include the spare parts which make up a whole PCB, such as resistor, capacitor, integrated circuit, connectors, etc.

○ : Indicates that the concentration of the hazardous substance in all homogeneous materials in the parts is below the relevant threshold of the GB/T26572 standard.

× : Indicates that the concentration of the hazardous substance of at least one of all homogeneous materials in the parts is above the relevant threshold of the GB/T26572 standard.

Notes of environment-friendly lifetime

Lifetime of this electrical and electronic products, if operated as set forth in the manual, with the hazardous substance or element not to emit, neither to pollute the environment nor to cause harm to person or property, is limited to 10 years.







▶ TECHNICAL SPECIFICATION

Model Number	: Dynasty
Rated Voltage	: 110-120V~
Rated Frequency	: 50/60Hz
Rated Power	: 220W
Safety Design	: Class I
Maximum User Weight	: 300 LBS
Chair Weight	: 303.6 LBS
USB Charging Port	: 1.5A

▶ SAFETY PRECAUTIONS

- ▶ Precautions listed below will help to ensure proper use of this appliance.
- ▶ The hazard that may cause by incorrect use are classified into "WARNING" and " CAUTION", please ensure that you read all instructions before using the massage chair.

 WARNING	Improper operation may cause severe personal injury or substantial property damage.
 CAUTION	Improper operation may cause personal injury or product damage.
 Prohibited	 No Disassemble

Not Suitable For Below Persons

We recommend that those with any of the following conditions should consult your physician before using.

 WARNING	◆ Those who are using electronic medical instrument embedded in the body, such as cardiac pacemaker.
	◆ Those undergoing treatment, especially those who are not feeling well.
	◆ Those with malignant tumors or malignant abscesses.(Need to be supervised)
	◆ Women who are pregnant.
	◆ Those with osteoporosis or fracture spine.
	◆ Those with skin disease or those whose skins are injured.
	◆ Those with high fever.
	◆ Close supervision is necessary when this product is used by, on, or near children, invalids, or disabled persons
	◆ The appliance has a heated surface. Persons insensitive to heat must be careful when using the appliance.
	◆ This appliance can be used by children aged from 8 years and above and persons with reduced physical, sensory or mental capabilities or lack of experience and knowledge if they have been given supervision or instruction concerning use of the appliance in a safe way and understand the hazards involved.
	◆ Children shall not play with the appliance.
	◆ Cleaning and user maintenance shall not be made by children without supervision.

Control Buttons Precautions

 CAUTION	◆ Do not operate the control buttons with wet hands.
	◆ Do not spill water or other liquid onto the control buttons to avoid fault.

Cautions Regarding the Adapters and Cord



 CAUTION	◆ Always unplug this appliance from the electrical outlet immediately after using and before cleaning.
	◆ An appliance should never be left unattended when plugged in. Unplug from outlet when not in use.
	◆ Unplug from outlet during thunder or lightening storms, and before putting on or taking off parts.
	◆ Never operate this appliance if it has a damaged cord or plug, if it is not working properly,if it has been dropped or damaged,or dropped into water. Return the appliance to a service center for examination and repair.
	◆ Check that the power voltage stated on the rating label corresponds to your local electricity supply.
	◆ Do not use a damp hand to unplug the cord to avoid electric shock.
	◆ Do not drag the cord,reach to the front plastic end to unplug it.
	◆ Do not squeeze,over bend , pull hard, twist the cord.
	◆ Keep the cord away from heated surfaces.
	◆ Do not carry this appliance by supply cord or use cord as a handle.
	◆ To disconnect, turn all controls to the off position, then remove plug from outlet.
	◆ The appliance is only to be used with the power supply unit provided with the appliance.
	◆ It must only be supplied at safety extra low voltage corresponding to the marking on the appliance.
◆ If the supply cord is damaged, it must be replaced by the manufacturer or its service agent or a similarly qualified person in order to avoid a hazard.	

SAFETY PRECAUTIONS

Best Circumstances

 CAUTION	<ul style="list-style-type: none"> ◆ Do not operate under blanket or pillow. Excessive heating can occur and cause fire, electric shock, or injury to persons. ◆ Do not use this appliance where temperature is over 40 C. ◆ Do not use this appliance in humid or dusty environment, or when any part of the body is in contact with plumbing or any similar ground. ◆ Never operate the appliance with the air openings blocked. Keep the air openings free of lint, hair, and the like. ◆ Do not use outdoors. ◆ Do not operate where aerosol (spray) products are being used or where oxygen is being administered. ◆ Please place the product on the flat level floor. ◆ Do not store near heat or open flame. ◆ Connect this unit to a properly grounded outlet only. See Grounding Instructions.
---	--

Best Practices For Safe Use

 CAUTION	<ul style="list-style-type: none"> ◆ Only for users weighs below 300 lbs. ◆ Use this product only for its intended use as described in this manual. Do not use attachments not recommended by the manufacturer. ◆ Appliance should only be used by one person, do not use by two or more persons at the same time to avoid damage to the products. ◆ Do not use the product right after meal, it may cause discomfort. ◆ Remove the accessories from the arms and empty the pockets while use the massage services. ◆ Check the upholstery under the cushions and other spots, if any damages are present, do not use it and refer to a qualified service professional for servicing. ◆ If you feel any abnormal discomfort during the operation of this product, turn off the power immediately and do not use the product. ◆ Use the appliance for 20 minutes each time is highly recommended ◆ Make sure there is no obstacles behind the chair and there is enough clearance before adjusting the backrest or legrest angle. ◆ Make sure no other excessive load pressed on the backrest or legrest besides the user. ◆ Make sure there is no children, pets or other objects under the backrest or legrest. ◆ Please be seated properly while using the appliance. ◆ Do not drag or push the chair or roll on its caster on wood floor or carpet to avoid damage.
 PROHIBITED	<ul style="list-style-type: none"> ◆ Do not stand on or stack heavy objects on the footrest. ◆ Do not fall asleep while the product is operating. ◆ Avoid using the product under the influence of alcohol. ◆ Never drop or insert any object into any openings. ◆ If there is any smoke or unusual smell while using, stop using immediately, unplug the power cord.
 NO DISASSEMBLY	<ul style="list-style-type: none"> ◆ Do not disassemble this product yourself to avoid failure. ◆ Do not dismantle, fix or modify the yourself, Please contact authorized dealer or service agent.

TROUBLE SHOOTING

No.	Symptoms	Possible Causes	Possible Solutions
1	Noise is heard while in use	These noises are normal and arise from friction between the massage rollers and the leather cover.	No need to take any measures
2	Massage Chair does not start	The power cord is not secured into the socket	Insert the power plug properly into the power socket
		Not switched on	Turn on the switch found on chair side. Then push power button on remote.
		The fuse is blown	Replace only with a fuse of same type and rating
3	No music comes from the speaker	The volume is turned to the lowest	Adjust the speaker volume from the mobile devices. Make sure Bluetooth setting in chair and phone are both on.
4	Backrest or footrest can not raise or recline	Excessive load has been pressed on the backrest or legrest	Reduce the load and try again
5	Airbag malfunction	The air hose is blocked	Straight the air hose and clear out the blockage
6	Nature sounds are not playing	Bluetooth is OFF	Make sure Bluetooth is set to ON

If problem remains, please contact the Infinity for maintenance.

Tips: Do not attempt to repair this product yourself, our company shall not be liable for the injury or damage caused by any servicing without authorization. Thank you for your cooperation.

CARE AND MAINTENANCE

Care and Maintenance Instructions

- ▶ To treat stains on back panel, armrest, footrest, plastic parts or air hose, spot clean with mild detergent foam, then wipe it with a dry cleaning cloth.
- ▶ To treat stains on controller, power box, spot clean with a dry cleaning cloth.
- ▶ To treat stains on back cushion or pillows, use a water-based upholstery cleaner only, wipe it with moist cloth, then air dry.
- ▶ To clean the foot/calf unit covers, remove from the chair, hand wash with a mild detergent, then line dry.

CAUTION

- ▶ Unplug cord before performing care and maintenance. To avoid electrical shock or injury, do not touch the power cord with wet hands. Make sure no detergent enter into the power box while cleaning.
- ▶ Do not use benzene, thinner or other solvents on your product, it may cause fading or damage to the product.
- ▶ Do not iron the upholstery

Storage Methods

- ▶ Keep the product free from dust. Cover the product with a dust-free cloth to prevent collection of dust if not in use of a long period of time.

CAUTION

- ▶ Do not leave this product exposed to direct sunlight for long periods of time. This may cause fading or damage

Warm Tips

During daily use, please check for the following symptoms:

- ▶ Burnt smell
- ▶ The product experiences unusual power ON/OFF when touching the power cord.
- ▶ Hot power cord
- ▶ Other abnormal symptoms

CAUTION

- ▶ Please stop using the product to avoid breakdowns or accidents if any above symptom spotted.
- ▶ Switch off the power button and disconnect the plug, contact Infinity for repair.
- ▶ All other servicing except above care and maintenance should be serviced by an authorized dealer or service center.

WARNING

Pull out the power cord from the power before care and maintenance. To avoid electrical shock or injury, do not handle the power cord with wet hands. Do not try to dismantle or repair the product yourself, please send your massage chair to the authorized service center.

NAME AND FUNCTION OF EACH COMPONENT

External Structure

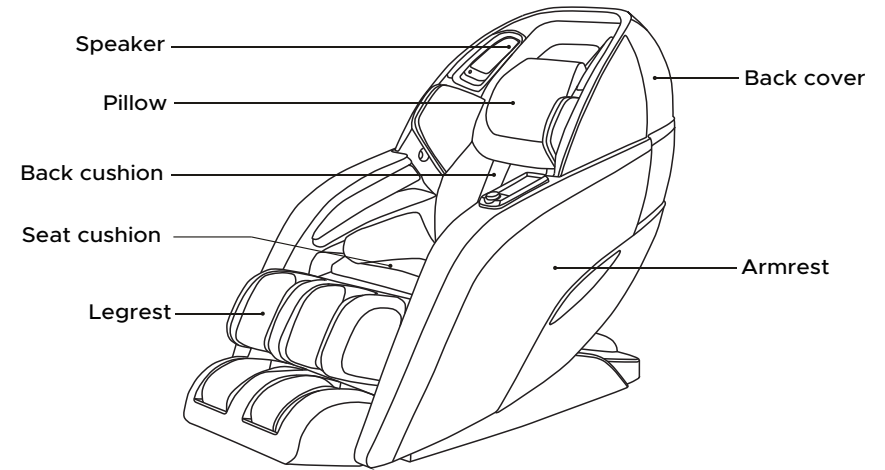

Internal Structure

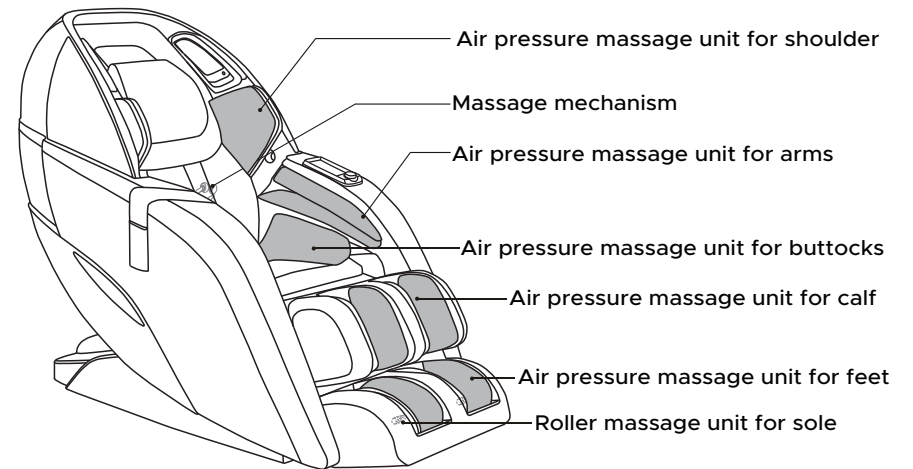

▶ NAME AND FUNCTION OF EACH COMPONENT

Remote Control



▶ PRELIMINARY CHECKS

Inspections Before Sitting

- ▶ Use the remote control to recline the backrest to its lowest position, raise and extend the footrest to its top position, make sure there is enough clearance before commissioning.
- ▶ Return the backrest and footrest back to its default position and turn off the power switch.
- ▶ Ensure the footrest is well assembled before sitting on the massage chair.
- ▶ Ensure the massage chair is returned to its original position before sitting on it. If there is any part not in default position, please turn off the massage chair to allow it to restore.

CAUTION

- ▶ Do not take seat while the footrest is lifted.
- ▶ Do not put excessive load on the footrest to avoid damage.

After Use

- ▶ Always unplug the massage chair from the electrical outlet immediately after use.
- ▶ Turn off the power switch and unplug the massage chair from the electrical outlet while not in use to avoid children power on the massage chair accidentally.
- ▶ When not in use for a long period of time, we recommend that the chair be covered, the power cord be coiled and that the unit be placed in an environment free of dust and moisture.

▶ PRELIMINARY CHECKS

Move Methods

- ▶ Turn off the power switch and unplug the appliance from the electrical outlet.
- ▶ Using two people, push down on the backrest and lift up on the front side by grabbing the moving Holder located to the front bottom of the armrest), roll the chair on its casters to the desired location (check the sketch for reference).
- ▶ Roll the chair on its casters to the desired location.
- ▶ Slowly incline the backrest to upright position.

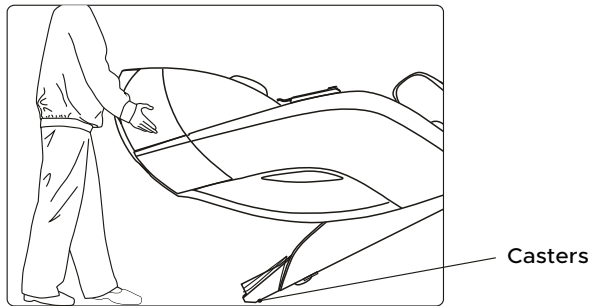

⚠ CAUTION

- ▶ Do not move the chair when there is user inside.
- ▶ To carry this product, do not lift by the footrest or armrest, hold the chassis and steady the backrest (have 4 or more people to carry the product).

Connect to Power

- ▶ Connect this appliance to a 3-wire properly grounded outlet.
- ▶ Turn on the main power switch by the right hand side of the massage chair.

⚠ CAUTION

- ▶ Please verify that there is no damage to the supply cord before switching on the massage chair.
- ▶ Please verify that the main power switch is turned off before connecting to power.

▶ NAME AND FUNCTION OF EACH COMPONENTS

Remote Control Instructions

-  **Power on/off:** Press this button to power on/off the controller.
 - ▶ Press this button while connected to power to show the Home display, the display screen lights up, use the up/down/left/right buttons to navigate the screen, press OK to select.
 - ▶ Press this button again to turn off the product.
-  **Home**
 - ▶ Display the AUTO program, MANUAL program, AIRBAG, IONIZER, HEAT, TIME, SOUNDS, LIGHTS and SETTING function. (Check the Display Menu for detailed information)
-  **Pause**
 - ▶ Press to pause massage chair function, press this button again to continue.
-  **Auto Program**
 - ▶ When massage chair is operating, press AUTO button to enter Auto Program Menu. Choose from SPORTS REFRESH, EXTENSION, REST & SLEEP, WORKING RELIEF, NECK & SHOULDER, WAIST & SPINE, DEEP SHIATSU, HEALTHY BREATH, MESSAGE EXTEND, RELAXATION, ALL AIR, DEMO
-  **Navigation**
 - ▶ Use the up/down/left/right buttons to navigate the display screen, press OK to select.
 - ▶ While massage program is running, press UP/DOWN button to change the Mechanism massage speed; press LEFT/RIGHT button to change the Airbag massage intensity.
-  **Zero Gravity Position**
 - ▶ Press to position the chair in Zero Gravity Position 1, press again to position the chair in Zero Gravity Position 2, press for the third time to restore to default recline position.
-  **Foot Roller**
 - ▶ Press to turn on foot rollers; press again to turn off foot rollers.

▶ NAME AND FUNCTION OF EACH COMPONENTS



Shoulder Position Adjust (Moves mechanism up and down)

- ▶ Press and hold on Position UP/DOWN button to adjust the rollers to the desired position while under manual program point zone mode
- ▶ Press and hold on Position UP/DOWN button to adjust the rollers to the desired position while under the body scan procedure.



Feet Up

- ▶ Press and hold to raise the Legrest, release the button to stop.

Feet Down

- ▶ Press and hold to lower the Legrest, release the button to stop.



Back Up

- ▶ Press and hold to raise the backrest, release the button to stop.

Back Down

- ▶ Press and hold to lower the backrest, release the button to stop.



4D Massage

- ▶ While massage program is running, press this button to change the 4D protruding intensity.



Footrest Extends

- ▶ Press and hold to extend the footrest, release the button to stop. (Make sure there is no obstruction in advance)

Footrest Retracts

- ▶ Press and hold to retract the footrest, release the button to stop.



CAUTION

- ▶ The remote control will give a single short beep sounds when press the buttons.
- ▶ The remote control will give short beeps to indicate that limit position is reached when incline or recline the backrest.
- ▶ Please do not play with the backrest incline/recline button to avoid fault.

▶ PRELIMINARY CHECKS

Step 4: Install the remote control unit

- ▶ Connect the remote control cable to the massage chair's port found in the side of the seat, being careful to line up the pins. Do not force. Then tighten the screw cap clockwise to secure the connector in place. (Check the illustration below for reference)

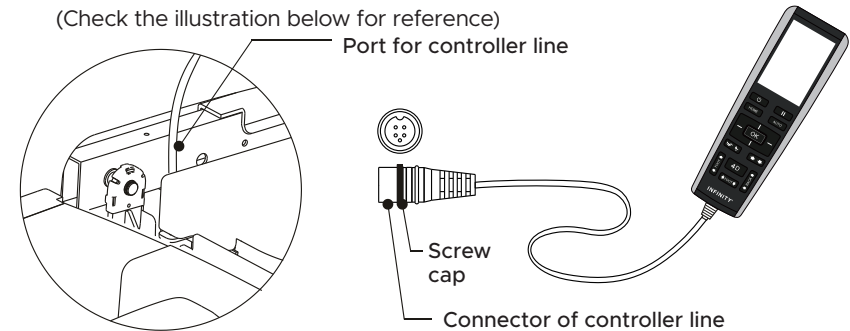

Step 5: Other Accessories

- ▶ Connect the power cord to the power box of the product.
- ▶ Plug the power into a grounded three prong socket, switch on the power, use the remote control to start operation.

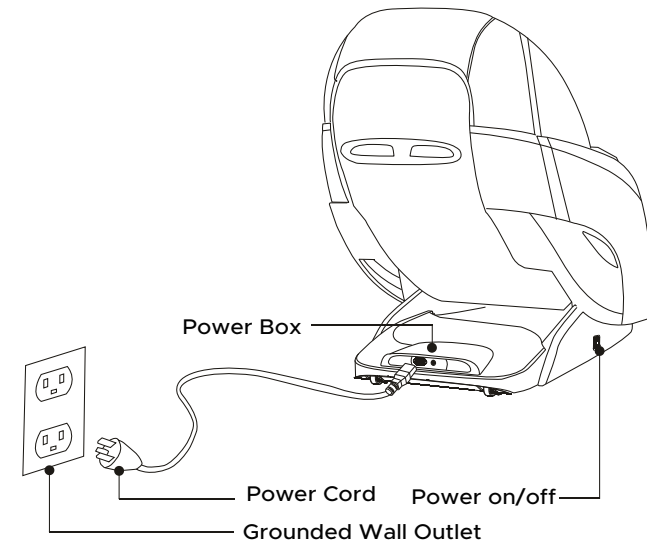

PRELIMINARY CHECKS

Step 3: Install the Legrest

- ▶ Lift the legrest unit, fit the Hook of the footrest unit into the Coupling Shaft located at the Seat base (Keep the hook leveled with the coupling shaft), connect one side first then the other.

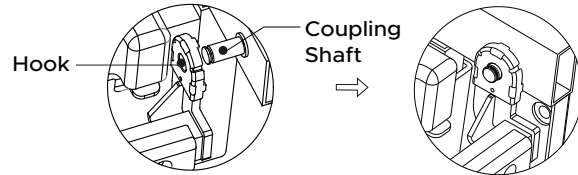

- ▶ Connect the footrest unit with the Coupling Shaft, fit the DK Circlip to the end of the shaft and lock it by pushing down firmly (check the illustration below).

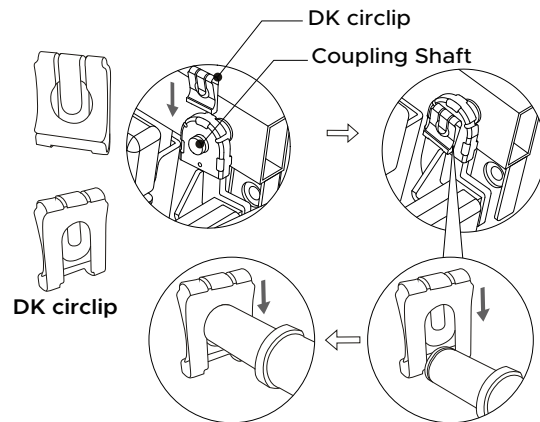

- ▶ Raise the legrest unit. Thread the air hose into the air nozzle and fit legrest drive wire connectors into the drive wire ports. Fit the air connector plug into the air valve port. Make sure they are well secured (Check the illustration below for reference).
- ▶ Zip up the cover and cushion.

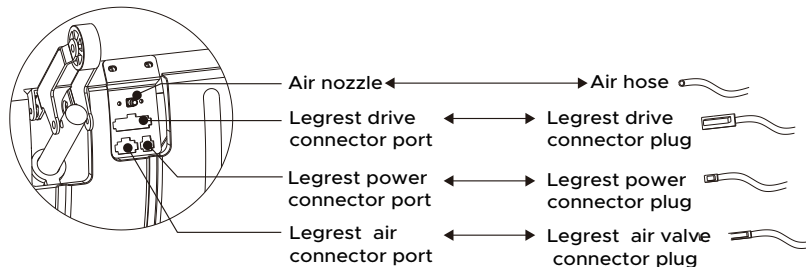

NAME AND FUNCTION OF EACH COMPONENTS

Display Screen Instructions

▶ Auto Massage Program

Press to display the Auto Program, select among 12 Auto Programs:

When massage chair is operating, press AUTO button to enter Auto Program Menu. Choose from SPORTS REFRESH, EXTENSION, REST & SLEEP, WORKING RELIEF, NECK & SHOULDER, WAIST & SPINE, DEEP SHIATSU, HEALTHY BREATH, MESSAGE EXTEND, RELAXATION, ALL AIR and DEMO. Press OK to enter the program you desire. Selected program will show on the home screen.

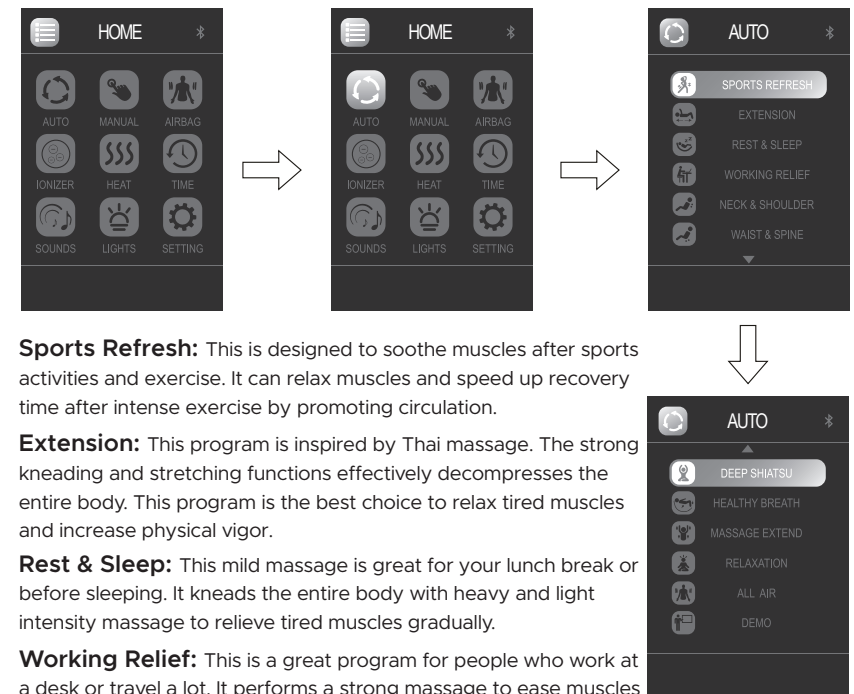

Working Relief: This is a great program for people who work at a desk or travel a lot. It performs a strong massage to ease muscles and recuperate the body.

Neck & Shoulder: This program relieves neck and shoulder pain, as 80% of the massage time focuses on the neck and shoulders. The curved design of the chair backrest allows the massage rollers to completely touch the shoulder and neck. This function effectively relieves fatigue in these areas.

Waist & Spine: To relieve the pain of the lower back, 80% of this massage focuses on the lumbar vertebra and the rollers will conduct targeted massage to relieve tension in this area.

▶ NAME AND FUNCTION OF EACH COMPONENTS

Deep Shiatsu: Deep shiatsu on the back for 10 minutes.

Healthy Breath: Rhythmic five-minute massage to aid with deep breathing.

Massage Extend: Designed for morning or midday relaxing, it helps to boost the viability of muscles.

Relaxation: Selected neck & shoulder massage techniques to soothing pain and tension in the neck and shoulders.

All Air: Full-body airbag-only massage.

Demo: A quick show of massage chair's features and functions.

▶ Manual Programs

Press Manual from Home display, press UP or DOWN button to navigate among: MODE, PART, WIDTH, SPEED and ROLLER.

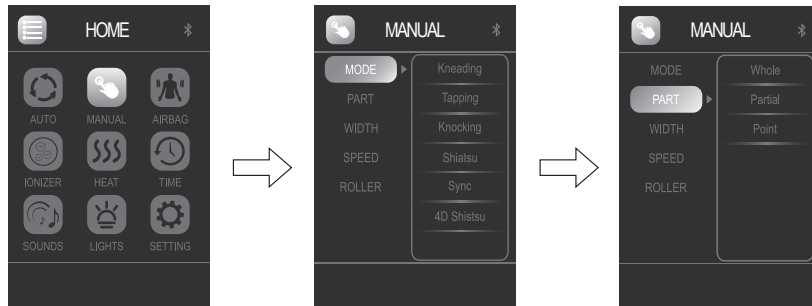

Massage Mode: Press MODE from MANUAL display, press RIGHT button then press UP or DOWN button to navigate among: Kneading, Tapping, Knocking, Shiatsu, Sync and 4D Shiatsu massage techniques. Press OK button to enter the setting you desire. Selected mode will show on the home screen.

Back Mechanism Massage Part: Press PART from MANUAL display, press RIGHT button then press UP or DOWN button to navigate among: Whole, Partial and Point massage regions. Press OK button to enter the setting you desire.

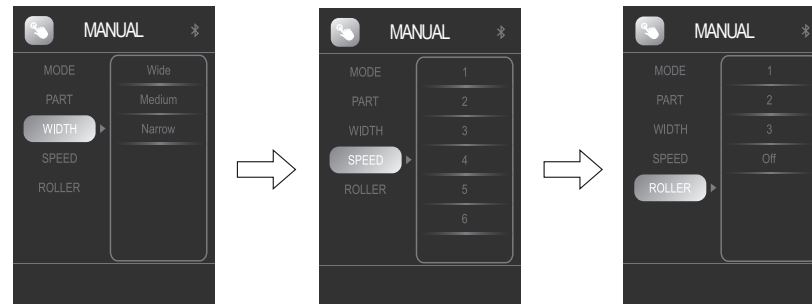

▶ PRELIMINARY CHECKS

Initial Assembly

Step 1: Take all massage chair parts out of the cartons

- ▶ Before beginning installation, please verify you received 3 boxes; chair body, arms and foot.
- ▶ Unpack the cartons: take out all upholsteries and accessories out of the cartons.

Step 2: Install Armrest Unit

- ▶ Connect the Air Hose of the Seat Base Unit with the Air Nozzle of the Armrest Unit.
- ▶ Hook the armrest onto the chair base, line up the Rear Hook connector with the Rod Connector and press the armrest unit by force to fit into place.
- ▶ Fit the screw into the Screw Socket.
- ▶ Fix a second screw into the front of seat base. (Repeat installation method with the other side)

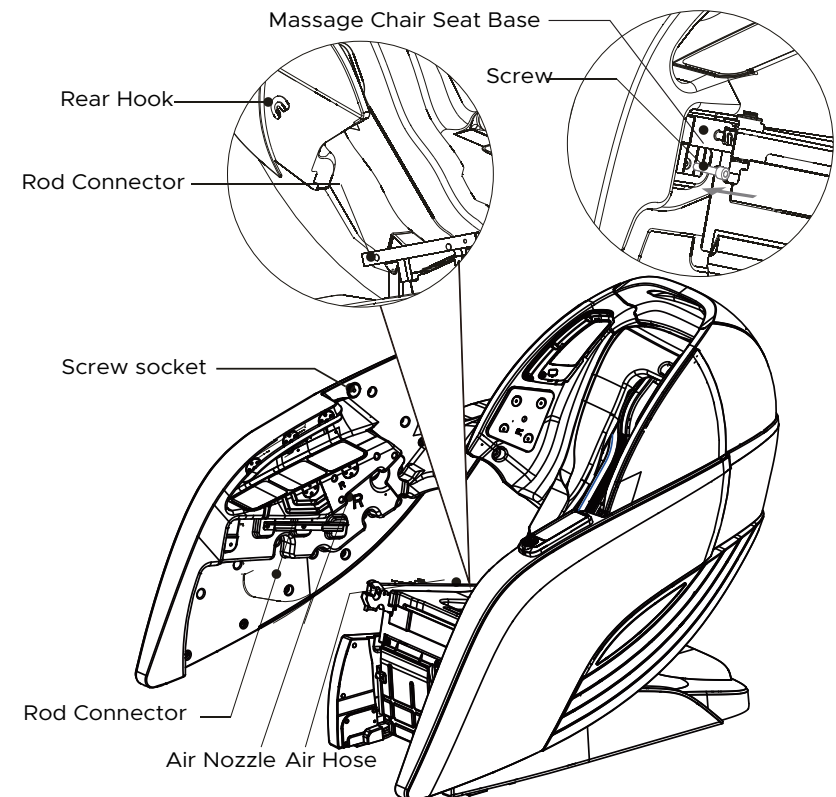

▶ PRELIMINARY CHECKS

Floor Protection

- ▶ We recommend to place a piece of thin carpet or soft mat underneath it to avoid damaging the floor.

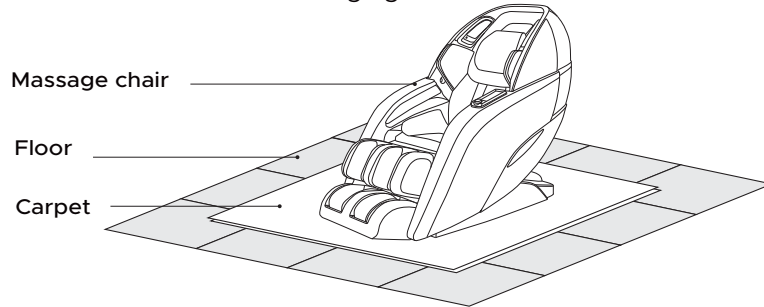

Best Circumstances



Do not use the massage chair in high moisture environment such as near swimming pool or bathroom to prevent electric shock accident.



Please keep the massage chair away from heated surfaces to prevent fire hazard or damage to the product.

⚠ WARNING

- ▶ Do not use the massage chair in high moisture environment such as near swimming pool or bathroom to prevent electric shock accident.
- ▶ Please keep the massage chair away from heated surfaces to prevent fire hazard or damage to the product.

Grounding Instructions

- ▶ This product must be grounded. If it should malfunction or breakdown, grounding provides a path of least resistance for electric current to reduce the risk of electric shock. This product is equipped with a cord having an equipment-grounding conductor and a grounding plug. The plug must be plugged into an appropriate outlet that is properly installed and grounded in accordance with all local codes and ordinances.



This product must be grounded, the plug must be plugged into an appropriate 3-wire grounded outlet that is properly installed and grounded in accordance with all local codes and ordinances to reduce risk of electrical shock.

▶ NAME AND FUNCTION OF EACH COMPONENTS

Back Mechanism Massage Width: Press WIDTH from MANUAL display, press RIGHT button then press UP or DOWN button to navigate among: Wide, Medium and Narrow mechanism roller width. Press OK button to enter the setting you desire. Selected width will show on the in-use screen. (Back Mechanism Massage Width can't adjust when under Kneading, Sync Manual mode)

Mechanism Massage Speed: Press Speed from MANUAL display, press RIGHT button then press UP or DOWN button to navigate among: level 1, 2, 3, 4, 5, 6 Mechanism massage speed. Press OK button to enter the speed level you desire. (Back Mechanism Massage Speed can't adjust when under Shiatsu, 3D Shiatsu Manual mode)

Foot Roller Speed: Press ROLLER from MANUAL display, press RIGHT button then press UP or DOWN button to navigate among: foot roller speed level 1, 2, 3, or OFF (deactivate foot roller). Press OK button to enter the speed level you desire.

▶ Air Pressure Massage Airbag

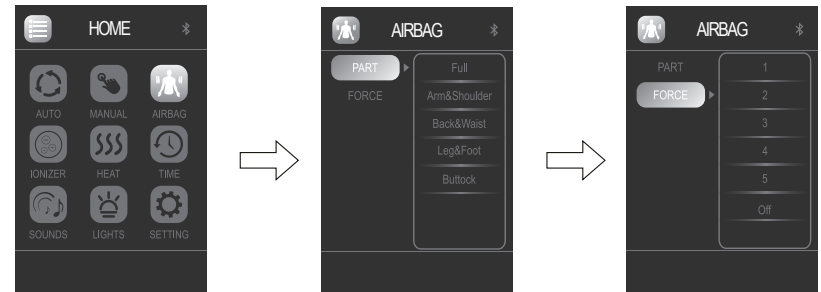

Part-Air pressure region: Press PART from AIRBAG display, press RIGHT button then press UP or DOWN button to navigate among: Full, Arm & Shoulder, Back & Waist, Leg & Foot, Buttock airbag positions. Press OK button to enter the airbag position you desire.

Force-Air pressure intensity: Press FORCE from AIRBAG display, press RIGHT button then press UP or DOWN button to navigate among: level 1, 2, 3, 4, 5 airbag intensity, or OFF (deactivate airbag intensity function), Press OK button to enter the airbag setting you desire.

▶ NAME AND FUNCTION OF EACH COMPONENTS

▶ Ionizer-Negative Ions

Press IONIZER from Home display, press RIGHT button, then press UP or DOWN button to turn on or off ionizer.

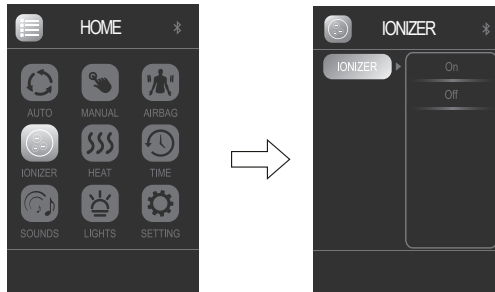

▶ Back Heat

Press HEAT from Home display, press RIGHT button, then press UP or DOWN button to navigate among: 1, 2, 3 heat level ,or OFF (deactivate heat function), Press OK button to enter the heat setting you desire.

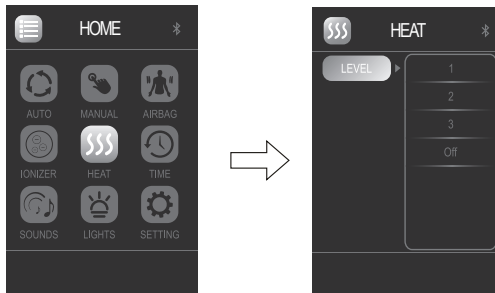

▶ Time

Press TIME from Home to show available timer: 10 mins, 20 mins, 30 mins, press RIGHT button, then press UP or DOWN button to navigate, press OK button to enter the timer you desire.

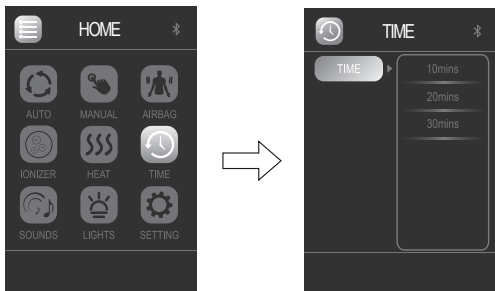

▶ PRELIMINARY CHECKS

Installation Site

Clearance space for the massage chair:

- ▶ Ensure there is an adequate clearance for the installation:It needs 4" clearance for the recline of the backrest; It needs 24" clearance space for the extension of footrest and sliding forward of the chair.
- ▶ Keep it 3 feet away from the TV, radio or other audio & video appliance to avoid signal interference.

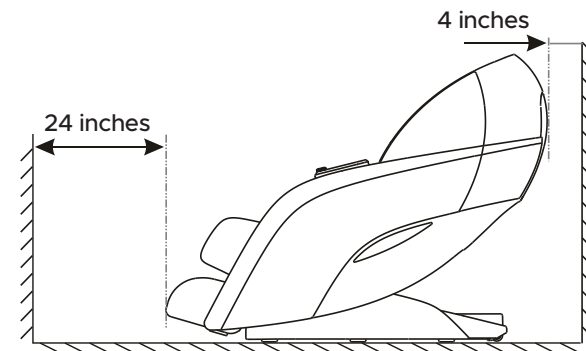

⚠ CAUTION

- ▶ Keep the distance between the power socket and power switch within 60" to avoid damage of power cord while massage chair sliding forward.
- ▶ Straighten the power cord while in use to avoid tangle or damage.
- ▶ When the massage chair sliding forwards or back, please check to make sure there is no children, pets or other obstacles around to avoid accident.

▶ APP DOWNLOAD AND INSTALLATION

Apple iOS: (iPhone or iPad devices)

- ▶ Open the App Store . At the top right corner, search for keywords like “Infinity Massage Chair, Dynasty, or massage chair” to find the Apple app. Click “Get” at the top right corner to download and install the software.
- ▶ In your device settings, open Bluetooth and connect it to the massage chair.
- ▶ Please note: Only Apple equipment compatible with Bluetooth 4.0 can connect to the chair’s Bluetooth.

Android System Software (Android System V2.2 or later)

- ▶ Download the Android app from the Infinity Massage Chairs Google Play store.
- ▶ Install Dynasty APK, then press Settings button on your computer or Android device > press Wireless and Web Setting > Bluetooth > Scan Bluetooth device > Dynasty, then pair.
- ▶ Start the APK, press Settings menu > Bluetooth > and pair with the Dynasty to link the APK

Bluetooth Connection Method

Bluetooth-Enabled Audio Devices

- ▶ This product has Bluetooth compatibility to connect with audio devices. Open Bluetooth from audio device and pair with Dynasty to play music.

CAUTION

- ▶ When connecting your Bluetooth-enabled device, please make sure the chair and Bluetooth setting is turned on, otherwise it will not find the chair

▶ NAME AND FUNCTION OF EACH COMPONENTS

▶ Sounds

Press SOUNDS from Home display, press RIGHT button then press UP or DOWN button to navigate among: SOUND, VOLUME, BEEP, and DEMO VOICE press OK button to enter the sounds setting you desire to control.

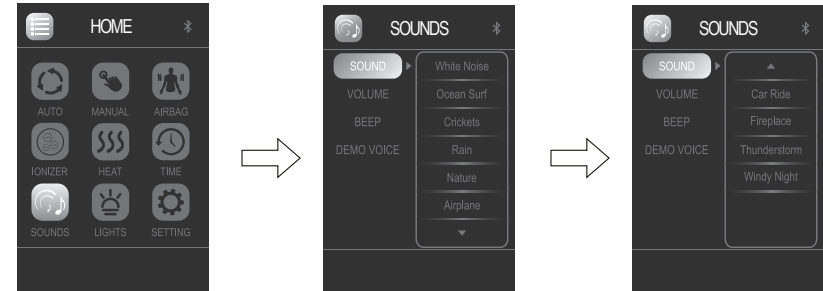

Sound: Press SOUND from SOUNDS display, press RIGHT button then press UP or DOWN button to navigate among: White Noise, Ocean Surf, Crickets, Rain, Nature, Air Plane, Car Ride, Fireplace, Thunder Storm, Windy Night press OK button to enter the sound setting you desire.

Note: Bluetooth must be ON for Sounds to work.

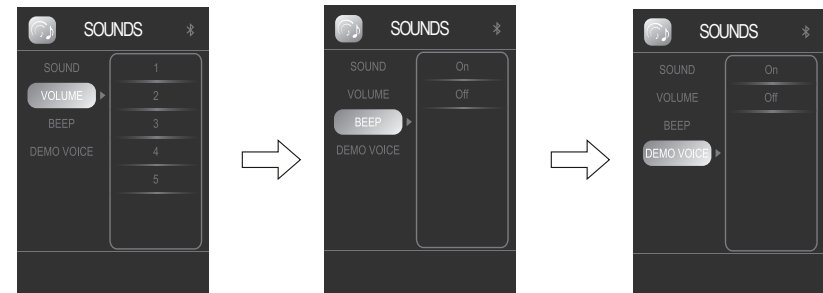

Volume: Press VOLUME from SOUNDS display, press RIGHT button then press UP or DOWN button to navigate among: 1, 2, 3, 4, 5 volume settings, press OK button to enter the volume setting you desire.

Beep: Press BEEP from SOUNDS display, press RIGHT button then press UP or DOWN button to turn on or off remote control beep.

DEMO Voice: Press DEMO VOICE from SOUNDS display, press RIGHT button then press UP or DOWN button to turn on or off DEMO voice. Voice demo only works on the DEMO program.

▶ NAME AND FUNCTION OF EACH COMPONENTS

Lights

Press LIGHTS from Home display to go into lights settings: THEMES, COLORS, BRIGHTNESS, press RIGHT button then press UP or DOWN button to navigate, press OK button to enter the option you desire.



THEMES: Press THEMES from LIGHTS display, press RIGHT button then press UP or DOWN button to navigate among: Solid, Breathe, Wake Up, Wind Down, Multi Wave and Multi Rotate, press OK button to enter the setting you desire

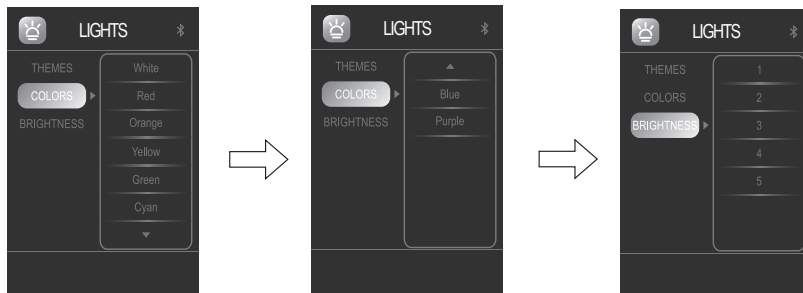

Colors: Press COLORS from LIGHTS display, press RIGHT button then press UP or DOWN button to navigate among: White, Red, Orange, Yellow, Green, Cyan, Blue and Purple, press OK button to enter the setting you desire. You may only choose colors in Solid and Breathe themes.

Brightness: Press BRIGHTNESS from LIGHTS display, press RIGHT button then press UP or DOWN button to navigate among: 1, 2, 3, 4, 5, press OK button to enter the setting you desire. 1 is the lowest setting, 5 is the brightest.

Turn lights off completely: From the home menu, navigate to LIGHTS and press OK. In the LIGHTS menu select THEMES and then select the theme program that is currently running and hit OK. This will turn the lights off.

▶ FEATURES

9. CALF MASSAGE

Calf-rubbing airbags surround each side of the lower legs while massager rollers knead the calves for extreme relaxation

10. JOYSTICK CONTROL & WIRELESS CHARGING

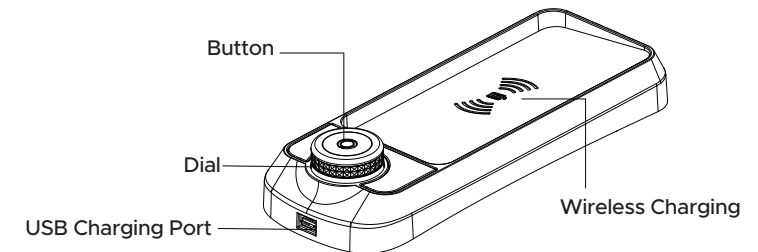

Button: Press to turn on chair. Press again to cycle through each auto program. The program name is announced through the speakers and starts immediately. Press and hold to turn chair OFF.

Dial: Use dial to recline and upright the Dynasty massage chair.

Wireless Charging Pad: Place any wireless charging-enabled phone directly on pad to charge.

▶ FEATURES

1. SPACE-SAVING ZERO-WALL FUNCTION

The Dynasty massage chair has the ability to move forward before performing a massage. This allows it to be placed closer to the wall than a standard massage chair. Keep this in mind when positioning the chair.

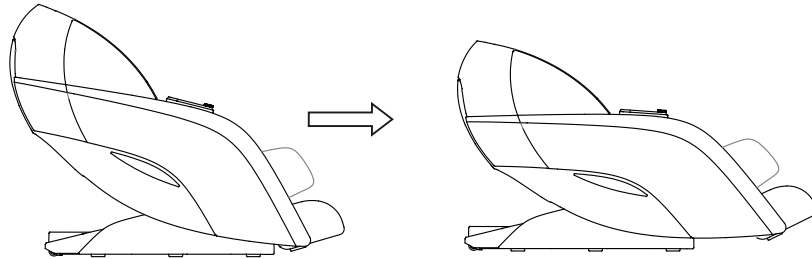

2. ZERO GRAVITY

Zero gravity creates a completely relaxing, naturally comfortable massage position. This design places the back, buttocks, and legs in the same angle that astronauts experience in space. Zero gravity provides a sense of weightlessness and promotes circulation and a steady heart rate.

3. 4D MASSAGE MECHANISM

New design of 4D mechanism and movement allow users to adjust the depth of their massage intensity.

4. AUTO/MANUAL LEGREST EXTENSION

Legrest can extend 3 in. to accommodate different leg lengths in both Auto and Manual Modes.

5. AIRBAG MASSAGE

Airbags are located throughout the chair in order to massage the arms, back, waist, shoulders, buttock, legs and feet.

6. FOOT MASSAGE ROLLERS

Three massage rollers in each foot unit conduct an all-over shiatsu massage on the sole.

7. DIVERSIFIED MASSAGE TECHNIQUES

Massage techniques include: knocking, kneading, tapping, kneading/knocking, combination, shiatsu, and kneading on the leg, which imitates a professional massage therapist.

8. BLUETOOTH AUDIO

The massage chair includes Bluetooth compatibility. Easily play music by connecting your Android or Apple device.

▶ NAME AND FUNCTION OF EACH COMPONENTS

▶ Setting

Press MENU button, then choose SETTING. Use the up or down button to toggle language, voice, brightness, buttons, beep, bluetooth, or sleep mode settings.

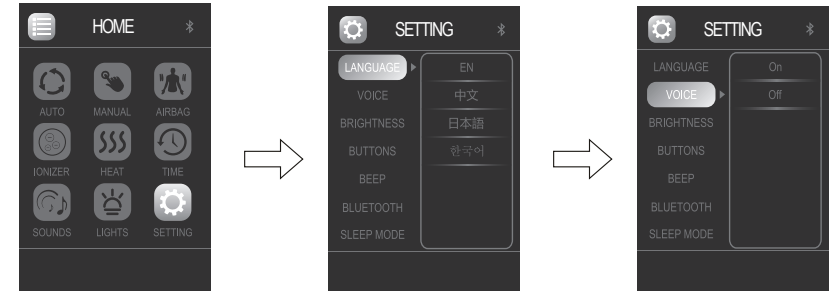

LANGUAGE: Under SETTING > LANGUAGE function, press right button, then press up or down button to set CHINESE , ENGLISH, JAPANESE or KOREAN.

VOICE: Under SETTING > VOICE function, press right button, then press up or down button to turn on or off the voice control function. Touch the button on the left speaker or say “Switch to voice mode” to activate the voice control function.

Spoken Commands	
Switch to voice mode	
Power On	Deep Shiatsu
Switch Off	Healthy Breath
Activate Massage	Massage Extend
Sports Refresh	Relaxation
Extension	Air Bag Massage
Rest & Sleep	Demo
Working Relief	Zero Gravity
Neck & Shoulder	Start Heat
Waist & Spine	Heat Off

▶ NAME AND FUNCTION OF EACH COMPONENTS

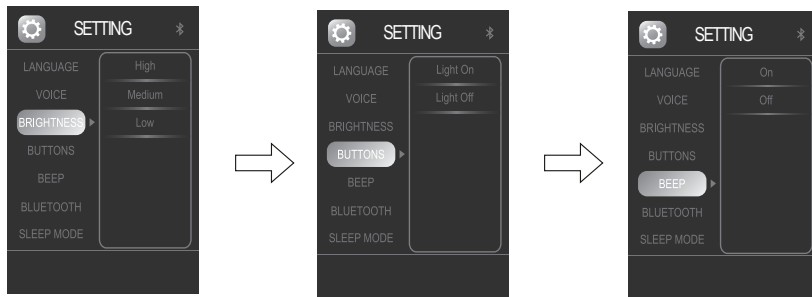

BRIGHTNESS: Under SETTING > BRIGHTNESS function, press the right button then press up or down to select display screen brightness. Press ok to set.

BUTTONS: Under SETTING > BUTTONS function, press the right button then press ON or OFF to control remote key backlight setting.

BEEP: Under SETTING > BEEP function, press up or down button to START or STOP remote Beep sound.

BLUETOOTH: Under SETTING > BLUETOOTH function, press up or down button to turn on or turn off Bluetooth.

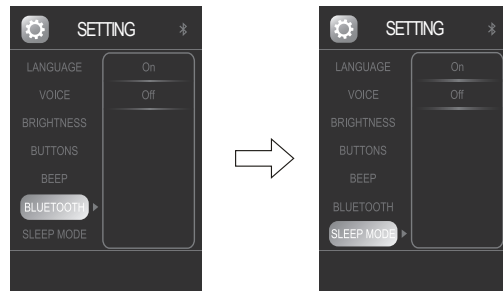

SLEEP MODE: Under SETTING > SLEEP MODE function press the right button then select ON to stop the chair in the reclined position after Auto Programs. Select OFF to have the chair return fully upright after each Auto Program.

▶ NAME AND FUNCTION OF EACH COMPONENTS

Note:

Under both Auto Mode and Manual mode, the remote will return to In-Use page as shown below if it remains idle for 10 seconds.

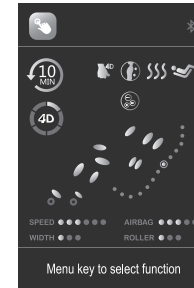

In-Use page in Manual Mode

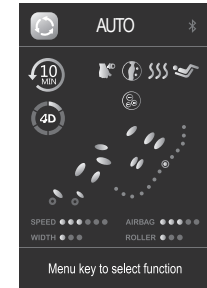

In-Use page in Auto Mode



Note:

- ▶ Please do not spill water or other liquids on the controller in order to avoid key malfunctions and error codes.
- ▶ Please do not place heavy objects on the controller or power cord.