



POSITIVE POSTURE®

BRIO

SPORT

OWNER'S MANUAL



Read this manual thoroughly before you start using your massage chair. In particular, please pay close attention to the sections of this manual devoted to safety.

Follow the instructions in this manual for the safe use and maintenance of your massage chair. This manual should be kept on hand as a reference.

This product is designed for home use.

**POSITIVE POSTURE MASSAGE CHAIR
BRIO SPORT**

CONTENTS

02	Introduction
03	Cautions & Warnings
11	Main Features
13	Parts & Functions
16	Assembly
24	Moving the Chair
25	Remote Functions
28	Sessions
30	Operation & Use
42	Care & Storage
43	Troubleshooting
47	Warranty & After Sales Service
48	Specifications

NOTE: The pictures in this manual are only for reference. Please refer to the actual product.

INTRODUCTION







Congratulations on your Positive Posture Brio Sport massage chair purchase!

As someone who cares about health and fitness, your goal is to maximize your body's performance. A complete fitness regimen combines exercise with recovery. Wear-and-tear and minor injuries naturally occur with the strenuous movements associated with exercise. Incorporating massage into your conditioning program is one of the best things you can do to maintain your body's physical health, achieve your fitness goals more quickly, and stay positive.

Both the physiological and psychological benefits of massage make it an ideal complement to a total conditioning program. Get in shape faster with less stiffness and soreness. Recover faster from workouts and relieve conditions that may cause injury. Provide your mind, body and soul the rest and relaxation it deserves so that you can be at your best!

CAUTIONS & WARNINGS

Indications, Symbols, & Descriptions

 WARNING	This action could result in serious injury or death
 CAUTION	This action could result in personal injury or damage to property
	This action is prohibited
	Further action is required
	Do not disassemble
	Unplug power cord from wall outlet

Important Safety Precautions

- Please follow all basic precautions while using this chair.
- Please read all instructions before using this massage chair. Refer to your Owner's Manual for important information about assembly as well as correct and safe procedures for using the chair.
- The above symbols are used to identify important safety instructions. Please familiarize yourself with these symbols and their meanings.
- Remember to keep this Owner's Manual in an easily accessible place.

General Safety



TO REDUCE THE RISK OF ELECTRIC SHOCK

Always unplug this appliance from the electrical outlet immediately after using and before cleaning.



TO REDUCE RISK OF BURNS, FIRE, ELECTRIC SHOCK, OR INJURY TO PERSONS

- An appliance should never be left unattended when plugged in. Unplug from outlet when not in use and before putting on or taking off parts.
- Do not operate under blanket or pillow. Excessive heating can occur and cause fire, electric shock, or injury to persons.
- Close supervision is necessary when this appliance is used by, on, or near children, invalids, or disabled persons.
- Use this appliance only for its intended use as described in this manual. Do not use attachments not recommended by the manufacturer.
- Never operate this appliance if the cord or plug is damaged, if it is not working properly, if it has been dropped or damaged, or if it has been exposed to water. If this happens, contact the service center for examination and repair.
- Do not carry this appliance by the supply cord or use the cord as a handle.
- Keep the cord away from heated surfaces.
- Never operate the appliance with air openings blocked. Keep the air openings free of lint, hair, etc.
- Never drop or insert any object into any opening.
- Do not use outdoors.
- Do not operate where aerosol (spray) products are being used or where oxygen is being administered.
- To disconnect, turn all controls to the off position, then remove plug from the outlet.
- Use heated surfaces carefully. May cause serious burns. Do not use over areas with sensitive skin or in the presence of poor circulation. The unattended use of heat by children or incapacitated persons may be dangerous.
- Keep children away from extended foot support (or other similar parts).
- Connect the appliance to a properly grounded outlet only. See Grounding Instructions.

CAUTIONS & WARNINGS

Grounding Instructions

This product must be grounded. If it should malfunction or break down, grounding provides a path of least resistance for electric shock. This product is equipped with an equipment-grounding conductor and a grounded plug. The plug must be plugged into an appropriate outlet that is properly installed and grounded in accordance with all local codes and ordinances.

DANGER: Improper connection of the equipment-grounding conductor can result in a risk of electric shock. Check with a qualified electrician or serviceman if you are in doubt as to whether the product is properly grounded. Do not modify the plug provided with the product—if it will not fit the outlet, have a proper outlet installed by a qualified electrician.

This product is for use only on a nominal 120V circuit and has a grounded plug that looks like the plug illustrated in Figure A below. Make sure that the product is connected to an outlet having the same configuration as the plug. An adapter should never be used with this product, such as shown in Figure B below.

YES

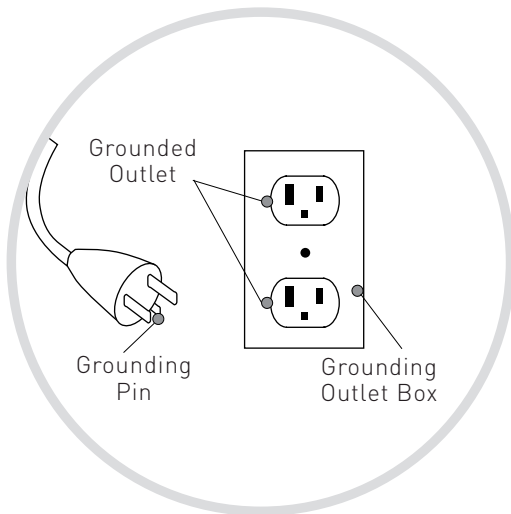

Figure A

NO

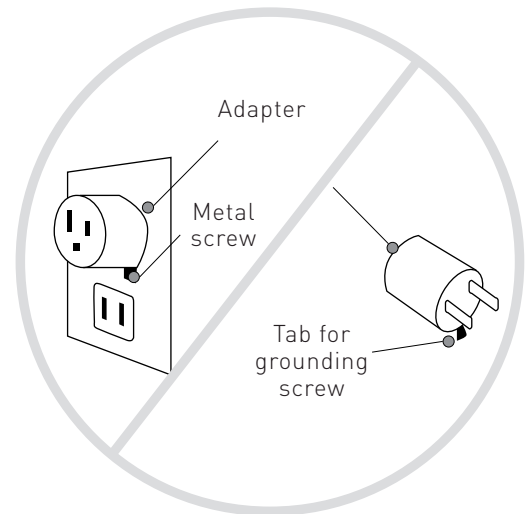

Figure B

Safety During Installation



- This product uses a normal Alternating Current (AC) circuit and has a ground pin as displayed in the figure to the right. Always make sure that the chair is connected to an outlet that has the same configuration as the plug, and is fully inserted into the outlet. If the chair should malfunction or break down, the grounding will provide a path of least resistance for electrical current to help reduce the risk of electric shock.
- This chair must be plugged into an appropriate outlet that has been properly installed and grounded in accordance with all local codes and ordinances. It is recommended to always use a surge protector.
- Do not use with any type of transformer device.
- Do not use the chair with a power supply other than those shown in the image on page 5 (Model, Power Supply AC120V).
- Make sure the main switch is in the OFF position before inserting the plug into the outlet.
- Any modification of the plug provided is prohibited and can cause serious injury. If the plug does not fit into an outlet, contact a qualified electrician for proper installation.
- Failure to connect the grounding conductor of the chair can result in the risk of electrical shock. If you feel the product is not properly grounded, please contact a qualified electrician.
- Please unplug this chair from the electrical outlet after use and before any cleaning or maintenance. To do so, ensure the main power switch is in the OFF position, then unplug the chair from the outlet.



- This product is intended for use described in this Owner's Manual. Do not use any attachments that are not recommended by the manufacturer.
- Do not use this appliance if the cord or plug is damaged, if it is not working properly, if it has been dropped or damaged, or if it comes into contact with water. In case of any of these scenarios, please contact Positive Posture Service immediately.
- Make sure all air openings are free of lint, hair, or other debris. Do not operate this appliance with the air openings blocked.
- Never use this appliance where aerosol spray products are used or oxygen is being administered.
- Excessive heating of this product can occur and cause fire, electric shock, or serious injury. Do not operate under a blanket, pillow, or heated surface.
- Do not try to move or carry this appliance by pulling or holding onto the power cord.
- Keep power cord away from all heated surfaces.

CAUTIONS & WARNINGS

Safety During Installation



TO AVOID ACCIDENT AND INJURY

- Install the chair on a flat and level surface.
- Allow at least 5" (12.75 cm) clearance from the chair's back to a wall to allow sufficient space for reclining up and down.
- Do not drop or slam the foot rest.
- This appliance is not recommended for children under the age of 14. Please keep children away while in use or storage.

TO AVOID DAMAGE

- Do not use outdoors.
- Stoves, heating products, direct sunlight, or other high temperature areas can cause fading, discoloration, or hardening of the upholstery. Please keep your chair away from this type of exposure.

Safety Before Use



PEOPLE NOT SUITABLE TO USE THE CHAIR

- People with circulatory problems (such as varicose veins or thrombosis), children, and those advised not to use a massage chair by their doctor should not use this chair.
- If you have any of the following health conditions, please consult your doctor for medical advice before using this chair: serious heart problems, serious diabetes, serious osteoporosis, serious skin conditions, malignant tumor(s), sensory impairment, pregnancy (or suspected pregnancy) or those who have just given birth, acute gastrointestinal complaints (gastritis, hepatitis, enteritis), joint dysfunction such as rheumatism, hammer toe and gout, thecitis (or suspected thecitis), high fever, spinal abnormalities due to past injury or ailment, curvature of the spine (scoliosis acute neck sprain (whip lash), or any other medical condition that may contraindicate usage of this product.
- Seek medical advice before using this chair if you have a pacemaker or other electronic medical device, if you have been restricted to bed rest, or if you are planning to use this chair to treat a specific ailment, to recover from surgery, or for therapy.
- Elderly people and those with weak bones should seek medical advice before using this chair even if they do not have a specific disease or disorder mentioned above.
- Do not use this chair if you have recently consumed alcohol.
- This appliance is not intended for use by persons (including children) with reduced physical, sensory or mental capabilities, or lack of experience and knowledge, unless they have been given supervision or instruction concerning use of the appliance by a person responsible for their safety.

Safety Before Use, continued...



TO AVOID ACCIDENT, INJURY, AND DAMAGE

- Children should be supervised to ensure that they do not play with the appliance.
- The appliance has a heated surface. Persons sensitive to heat must be careful when using the appliance.
- Do not use this chair for any other reason than described in this manual.
- Do not use this chair with any other therapeutic device or accessory besides those included.
- This chair is intended to be used with all the fabric attached. Failure to do so can result in serious injury.
- Check for any holes or tearing in the active massage area of the chair before each use. If a tear is noticed, stop using immediately and contact Positive Posture Service.
- Check the position of the roller mechanism prior to sitting down. If the rollers are not in the storage position, turn the power on and check that the chair is operating properly. For the proper storage position, see page 15.
- Do not move the chair while someone is in it.
- Do not stand on this chair.
- Do not sit on any part of the chair other than the seat.
- Do not sit, stand, or lean on the foot rest unless you are sitting in or getting up from the chair.

Safety During Use



TO AVOID ACCIDENT AND INJURY

- Do not wrap the power or remote cord around your body or place the chair on top of the cord.
- Do not scratch, tear, treat, twist, stretch, or bend the power or remote cord.
- Spilling water or other liquids on this chair may result in electric shock, short circuit, or combustion.
- Keep all children and pets off the chair and away from the surrounding moving area.
- Do not allow children, invalids, or disabled persons near the chair without close supervision. Keep all persons away from the reclining back rest and extending foot rest to avoid injury.
- Do not use the chair while more than one person is sitting in it, or when holding a baby or small child.
- Do not use the chair if any part of your body, including your hands, is wet.
- Do not use the chair unclothed.
- Do not use this chair for any purpose other than its intended uses outlined in this manual.
- Do not use the chair to massage the head, chest, stomach, and/or joints including knees and elbows.

CAUTIONS & WARNINGS

Safety During Use, continued...



TO AVOID ACCIDENT AND INJURY

- Do not place your hands or feet into the roller tracks, or into any moving parts, such as the reclining mechanism.
- Remove all hard objects, such hair accessories or jewelry, before using.
- Do not use the leg rest for anything other than legs or feet.
- Do not operate this massage chair without someone in it.
- Do not put your hands or head between or beneath the leg rest.
- Do not sleep in the chair.
- Never unplug the power cord during operation.
- Upon initial use of this chair, start off with a lighter massage. Starting off with a deep massage may result in injury. Elderly and people with weak bones should be careful while selecting massage intensity.
- If you notice any abnormal condition or in case of an emergency, push the Pause button on the remote to stop operation immediately.
- Immediately discontinue use of the chair and seek medical advice if you notice any acute pain or unusual physical discomfort.
- If the massage feels too strong, reduce the stimulation according to this manual. If it still feels too strong, discontinue use immediately.
- Do not use this chair with the back pad removed.



TO AVOID DAMAGE

- Do not use this chair if there is a power outage or the possibility of one. In this case, stop using the chair immediately, turn the power switch off, and unplug the cord from the wall outlet.
- Do not use this chair if there is a threat of lightning. If so, stop operation immediately, turn the main power switch off, and unplug the chair from the wall outlet.
- If a specific operation does not start or you find any incidence of abnormality, stop using the chair, turn off the main power switch, and unplug the cord from the wall outlet. Call Positive Posture immediately.

Safety During Use, continued...



TO AVOID DAMAGE

- Do not use this chair for any longer than 30 minutes each day. Avoid using a specific focused area massage for more than 5 minutes at a time. Long and continuous massage in the same position may cause discomfort or bodily harm.
- Do not attempt to force your leg, foot, arms, or hands back into the leg rest/arm rest if it comes out. Undue force may result in damage to the chair.

OTHER SAFETY PRECAUTIONS

- Do not cause any major impacts to the chair.
- Do not sit on any part of the chair other than the seat.

Safety After Use and When Not in Use



TO AVOID ACCIDENT, INJURY, AND DAMAGE

- Do not plug or unplug the chair with wet hands.
- Do not use any other power cord except the one supplied.
- Grasp the power plug when unplugging the cord from an outlet. Do not use the power cord to pull.
- Turn the main power switch off and unplug the power cord from the wall outlet after each use.
- Always recline the seat back to the upright position after using.
- Wipe down the chair after each use.
- Always store the chair in a low humidity environment.
- Do not place any objects on the chair.
- In case of malfunction, do not attempt to repair. Contact Positive Posture Service.
- Do not modify any part of the chair.
- Be sure to include this Owner's Manual when transferring this chair to another party.
- Do not dispose of this product or its accessories without consulting with your local authorities beforehand.

MAIN FEATURES

Intelligent 4D Massage Mechanism

The Positive Posture's *Sport4D* massage mechanism is designed to mobilize your spine, relax your mind, and help you recover from your workout. *Sport4D* kneads, taps, rolls (fast or slow), presses, and is expertly choreographed to do much more. Its deep tissue massaging capability helps improve blood flow, work tired muscles, and promote lymphatic flow. The unique quality and capability of the *Sport4D* mechanism will help you be your best every day!

L-Track

Featuring an L-Track massage path designed to guide the *Sport4D* mechanism to all the right spots from occiput (back of your head) down to your glutes and hamstrings. The Brio Sport L-track offers a total of 49" of back coverage.

Acupressure Point Locator Function

Before each massage begins, the chair scans your back and automatically customizes each massage to you. By measuring your torso and tailoring massage movements to your body, Brio Sport delivers maximum customized comfort, relief, and recovery to users of varying heights.

Heated Rollers

"Hot Rocks" style pinpoint heat is delivered through the 4D Intelligent Massage Mechanism's massage heads. The application of heat at the exact point being treated means that Brio Sport feels more like human hands and helps encourage blood flow to the muscles being worked.

Pinpoint Calf Massage

Your calf is expertly massaged with rear and side mechanical and air massage. The sensations which accompany Brio Sport's calf massage will soothe your whole body and help your calves feel revitalized and ready for whatever challenge your next day brings.

Foot Rollers

Carefully programmed and shaped to avoid over-stimulating the soles, the foot rollers will rub, roll, and squeeze your tired or sore feet to encourage blood flow, work muscles, and mobilize your entire foot.

Heat

Help your body and muscles warm up so they are ready for exertion. In addition to Heated Rollers, Brio Sport offers soothing heat under the seat and to the calves.

Full Body Air Massage

Air massage provides relief to your calves, thighs, IT bands, arms, hands, and shoulders. Your body and mind will benefit from the healing sensations of this carefully planned air-only massage. Perfect for people who want minimum intensity and no tapping or kneading movements.

Chromotherapy

Fitness is not only about physiological excellence, but that paired with clear state of mind. Brio Sport's chromotherapy sessions, that run on the screen of the remote, will help you achieve the psychological state of mind necessary to achieve your greatest goals.

NOTE: Chromotherapy must be activated within settings.

Automatic Reclining Function

The seat back can recline to 160 degrees, while the foot rest can be adjusted up to 80 degrees.

True Zero Gravity®

Improve blood circulation, breathe more easily and deeply and alleviate pressure on the joints and spine in the True Zero Gravity position.

Wall Hugging

Designed to fit almost anywhere, the unique wall hugging technology requires only 4" (10 cm) between the backrest and the wall.

USB Charger Port

Charge your device while you recharge your mind, body and soul.

Stylish and Easy Remote Control

Easy to read and easy to use, our tactile remote combines style and functional simplicity.

PARTS & FUNCTIONS

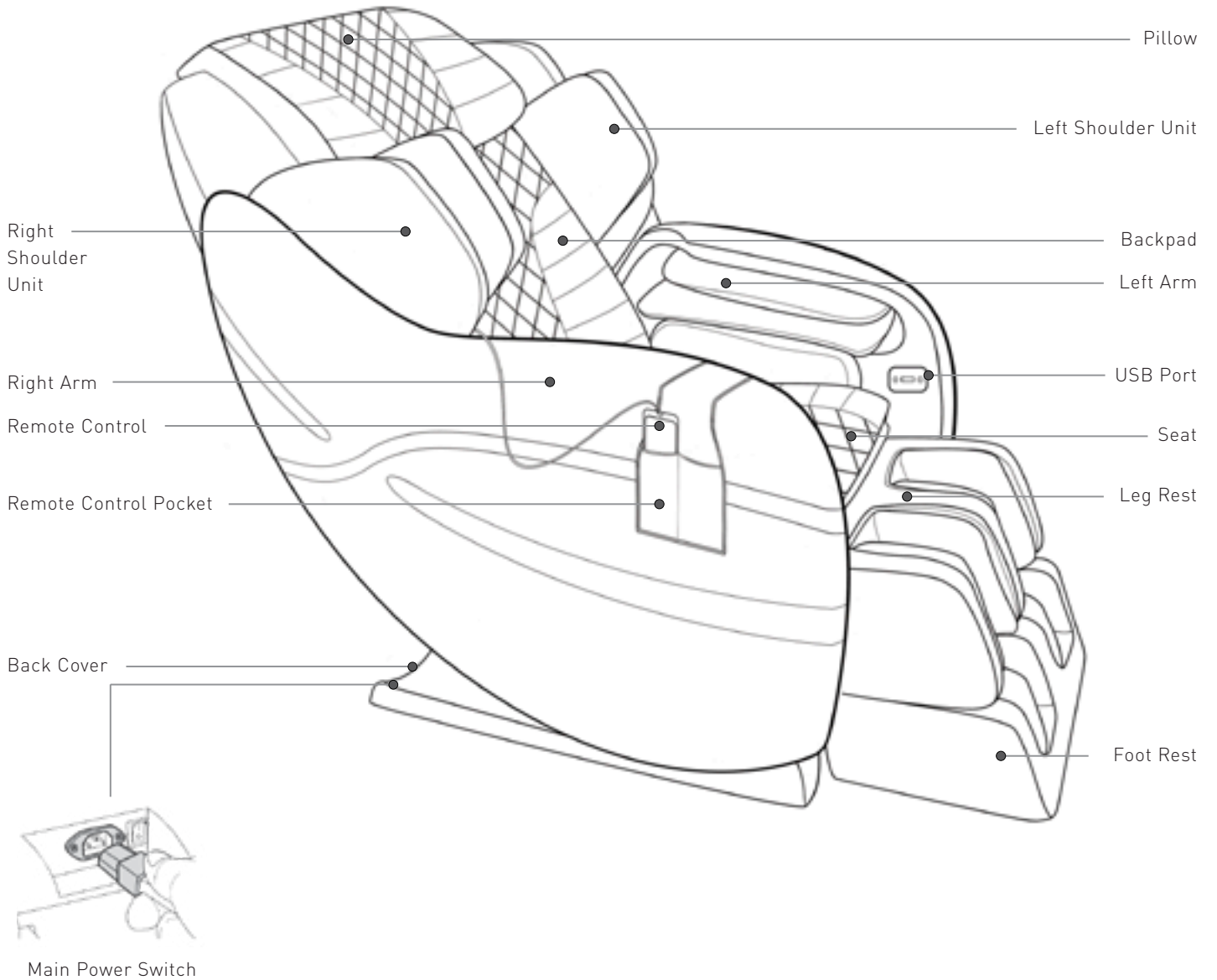

PARTS & FUNCTIONS

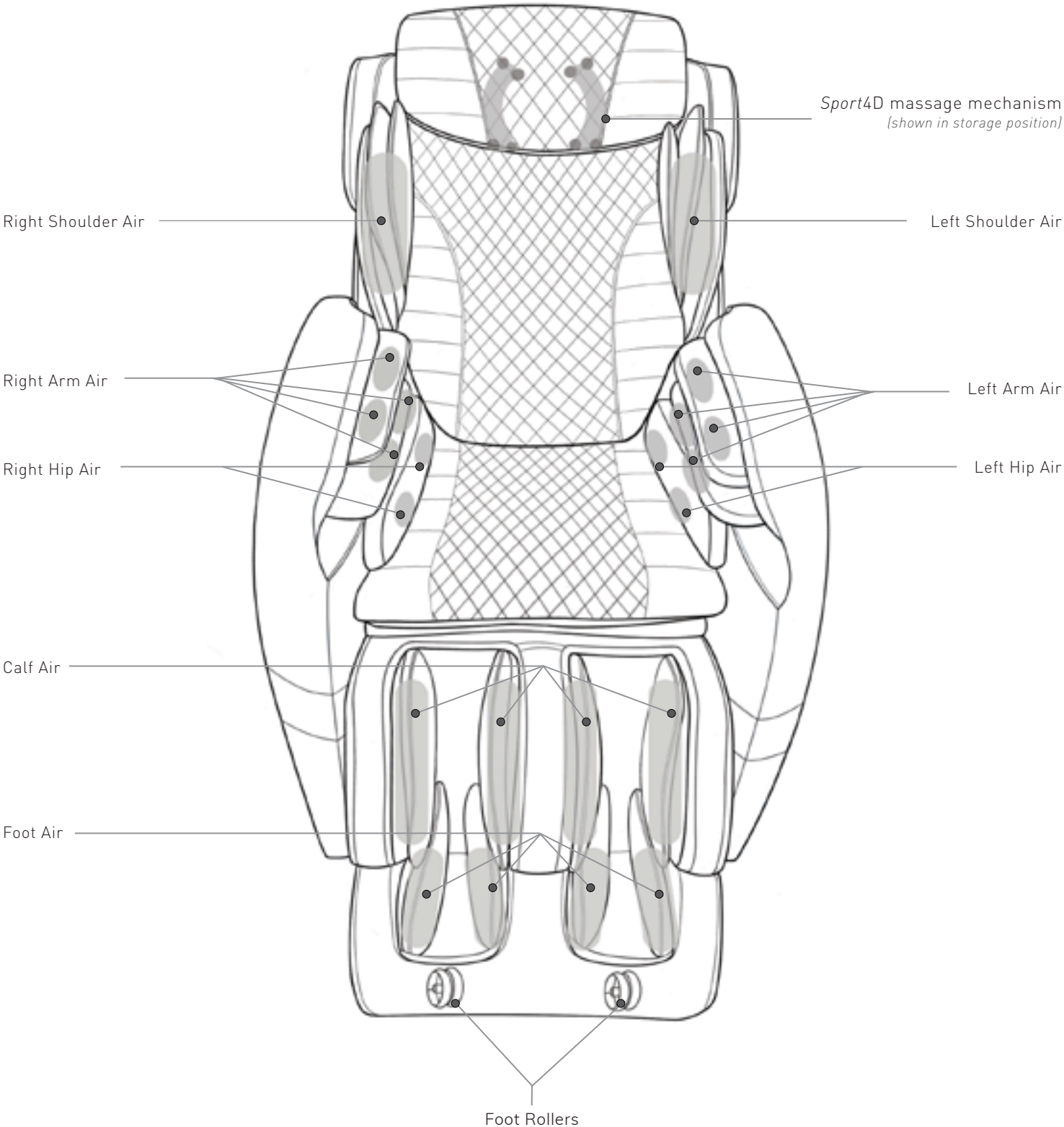

PARTS & FUNCTIONS

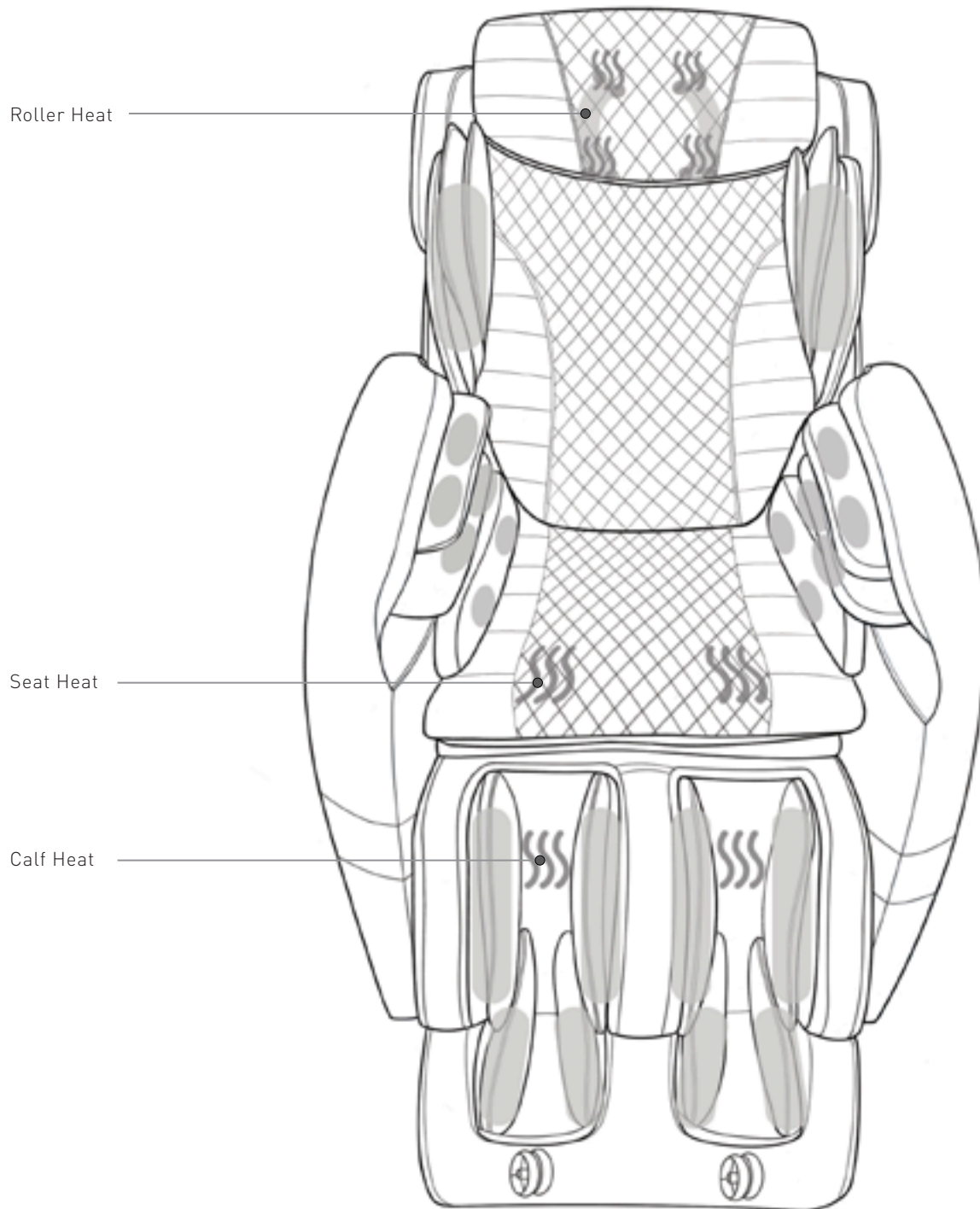

Safety During Installation



TO AVOID DAMAGE

- Do not install the chair in an area of high humidity, such as a bathroom or sauna.
- Do not use the chair in an excessively humid or dusty environment as this may result in malfunction or electric shock.
- Do not use the chair in a room with a temperature of 104-degrees or higher.
- Do not expose the chair to heaters, stoves, or direct sunlight.
- Keep fire sources, such as cigarettes and ashtrays, away from the chair.
- Ensure chair is installed on a flat and level surface to avoid tipping over.
- As the chair is heavy, please exercise extra care not to damage the floor when positioning the chair.

Assembly Preparation

- Ensure there is an allowance of at least 4" (10 cm) behind, and 12" (30 cm) in front of the chair to allow the back rest to recline and the leg rest to extend without obstruction during operation.
- Maintain a minimum distance of 3' (92 cm) from AV devices, such as a TV or radio, to prevent signal interference.
- It is recommended that a carpet be placed under the chair to prevent scratching the floor and to reduce noise during operation.
- As the chair is heavy, please exercise extra caution.

ASSEMBLY

Assembling the Chair

Important: Before starting, check the supplied items to ensure all parts are included in the package.

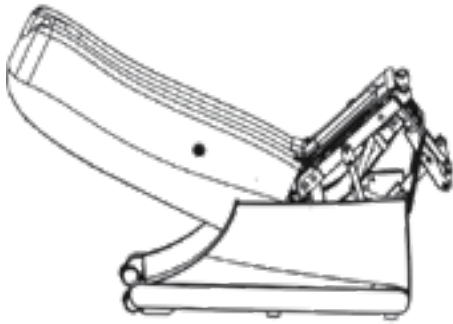

Base



Arms
(x2)



Foot Rest



Remote



Head Pillow



Supplemental Backpad

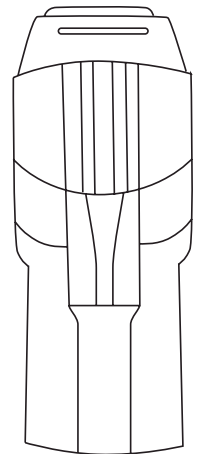

Back/Seat Pad



Foot Roller
Buffer Pads



Low Back
Buffer Pad



Power Cord



Straight Pins
(x2) (for carry handles)



Cap Head
Screws (x4)



Cotter Pins
(x2) (for carry handles)



T-wrench



Carry Handle Tools
(x2)



Channel Covers
(x2)

Assembling the Chair, continued...



- To prevent disconnection, be sure to double check all connections by gently pulling on the electrical connectors and air hoses.
- If not connected properly, the air cells will not inflate as designed.

STEP 1

Unbox chair and place in designated area.

STEP 2

Install channel plugs into the base of the chair.

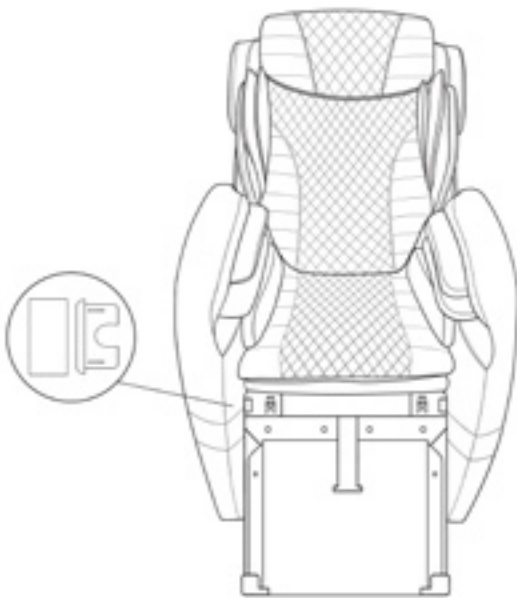

STEP 3

Power and incline the chair.

- A) Plug the power cord into the back base of the chair (Figure 3A), and
- B) Turn on the main power switch. The chair will automatically incline (Figure 3B).
- C) Turn off the main power of the chair.

Figure 3A

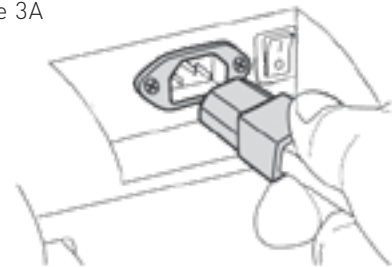

Figure 3B



ASSEMBLY

Assembling the Chair, continued...

STEP 4

Lay the Back/Seat Pad down so it sits on the base of the chair. Connect the heat line by pressing the line located on the back left of the main body of the chair together with the heat line located on the underside of the Back/Seat Pad.

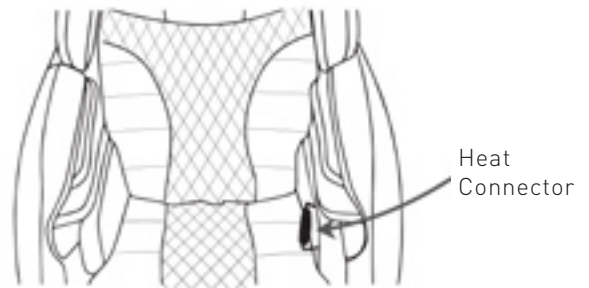

STEP 5

Secure the Back/Seat Pad connections with zippers as shown in Figure 5. Back pad zippers on the left and right sides of the back zip from the top down. Seat pad zipper should be seeded by starting the connection on the back left of the seat and wrapping around the front and right side. Top of the Back/Seat Pad connects with a zipper near the head of the chair.



STEP 6

Unbox leg rest. Then remove the two cap head screws located on front of chair base. Flip the hinged flaps up (Figure 6A). Place the leg rest in front of the chair to connect the one electrical connector and the three airlines from the leg rest to the base of the chair. Ensure that the electrical connector's tab faces upward and is fully snapped in, and that the airlines are color matched and pushed on as far as they will go (Figure 6B). With the hinged flaps flipped up, carefully lift the leg rest so the connection points on it align with the leg rest brackets on the base. Flip the hinged flaps back down and reinstall the two cap head screws (Figure 6C).

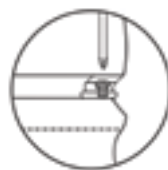

Figure 6A



Figure 6C



Figure 6B

STEP 7

Secure the Foot Rest's flap to the base of the chair by aligning the velcro just below the zipper for the seat pad as shown in Figure 7A. Then secure the zipper from the Foot Rest to the zipper on the seat pad of the chair as shown in Figure 7B.

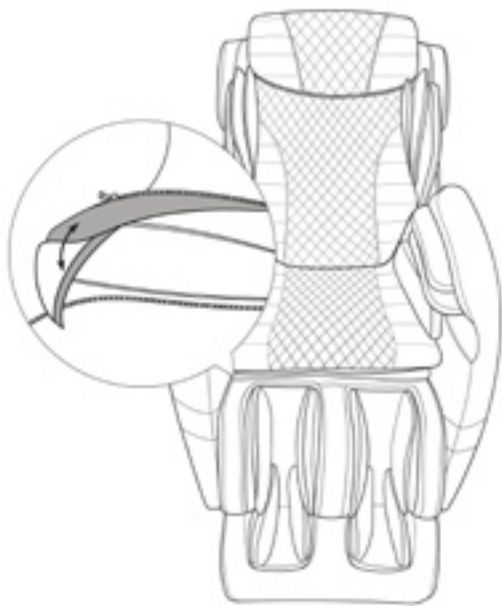

Figure 7A

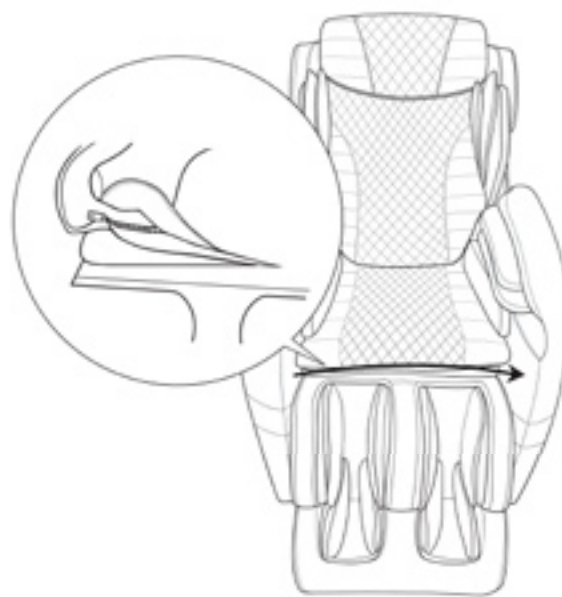

Figure 7B

ASSEMBLY

Assembling the Chair, continued...

STEP 8

Install the arms.

- A. Unbox the right arm.
- B. Lift the arm to align the arm's connection points (upper hook, and the two bolt holes on the base/bracket of the arm) as show in Figure 8B.
- C. Once aligned, carefully install the 2 screws to secure the arm to the base as shown in Figure 8C. Ensure alignment is perfectly accurate so you do not cross thread screws which will result in stripped screws.
- D. Connect the one electrical connector and the one airline from the arm to the base of the chair as shown in Figure 8D. Ensure that the electrical is fully snapped in, and that the airline is pushed on as far as it will go.
- E. Repeat Steps 8A-8D to install the left arm

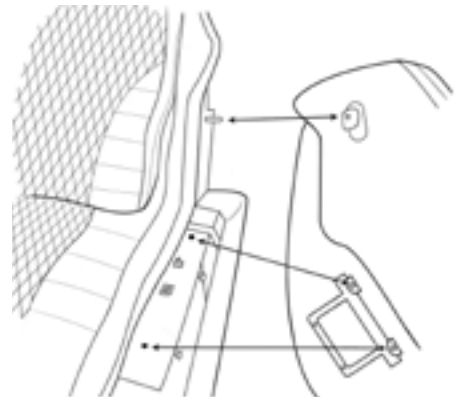

Figure 8B

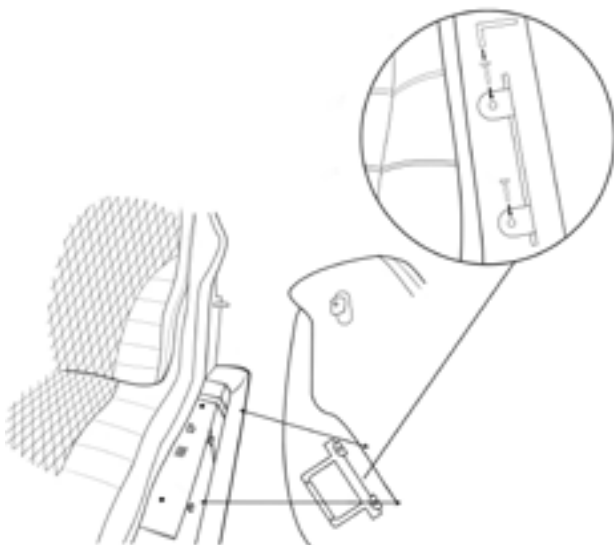

Figure 8C

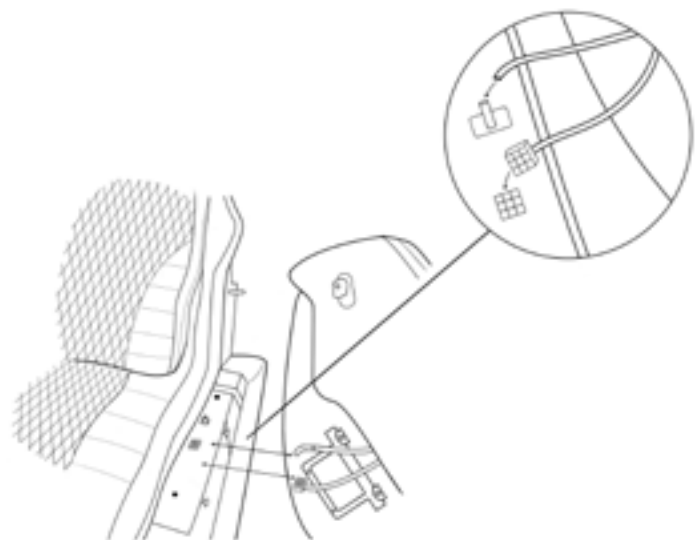

Figure 8D

Assembling the Chair, continued...

STEP 9

Connect the Head Pillow to the Supplemental Back Pad by securing with zippers as shown in Figure 9A, then secure this to the chair, by slipping the Head Pillow flap under the loop located at the top/head of the chair as show in Figure 9B.

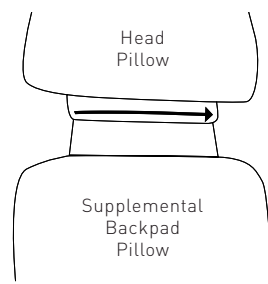

Figure 9A

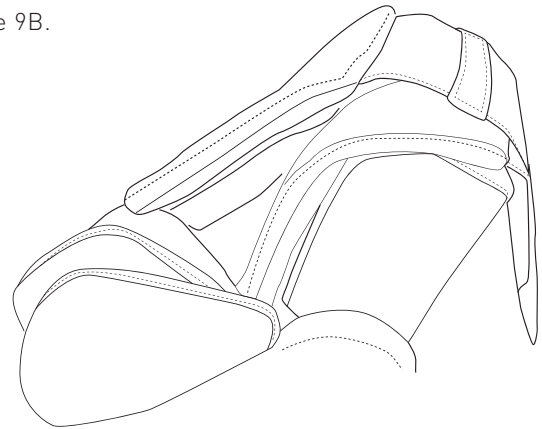

Figure 9B

STEP 10

Connect the electrical connector for the USB Power Port as shown in Figure 10. One end of the electrical connector will be found on the right arm and the other end on the right side of the base of the chair (near the seat). Ensure electrical connector is fully snapped in.



STEP 11

Install the remote control by finding the female portion of the connector located on the end of the remote control's cord, and securing it to the male portion of the connector located on the base of the chair as shown in Figure 11. Press the two parts together, then twist the circular metal connector until connection is fully seeded.



ASSEMBLY

Assembling the Chair, continued...

STEP 12

Insert the remote control into the remote pocket and manage the remote cable along the back of the chair by securing it with the two velcro tabs located on the back side of the right arm/base as shown in Figure 12.

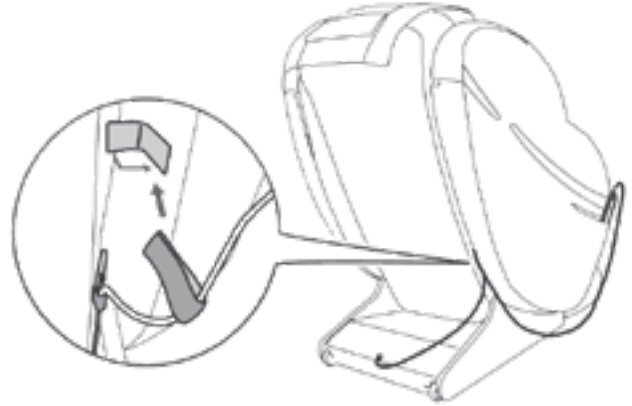

STEP 13

Turn on the main power to begin using the chair.





TO AVOID DAMAGE

- Never move the chair while it is operating or when someone is in it.
- As the chair is heavy, please exercise extra care not to abruptly drop it. This may cause damage to the floor as well as the internal components of the chair.

Before moving the chair, turn off the main power and disconnect the power plug from the wall outlet.

Bind the cables and put them in the seat to avoid damage when moving the chair.

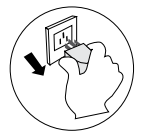

OPTION 1

Using the provided carry handles, have one person carefully lift the foot rest end, while a second person lifts using the handle on the back of the chair.

Carry to desired location.



OPTION 2

- Attach the provided carrying handles to the base frame. Secure by sliding straight pin through the hole in the handle and into the base as indicated below.
- Using two hands, grab the chair handles and gently lift until the chair is tilted back and resting on the casters located at the opposite end of the base. While the chair is lifted and resting on the casters, roll the chair into the newly desired position.

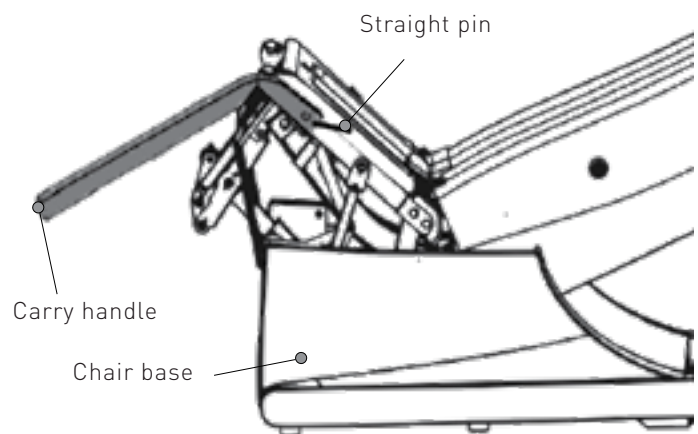

Attach carry handle as shown; slide bolt through carry handle and into frame to secure.

REMOTE FUNCTIONS







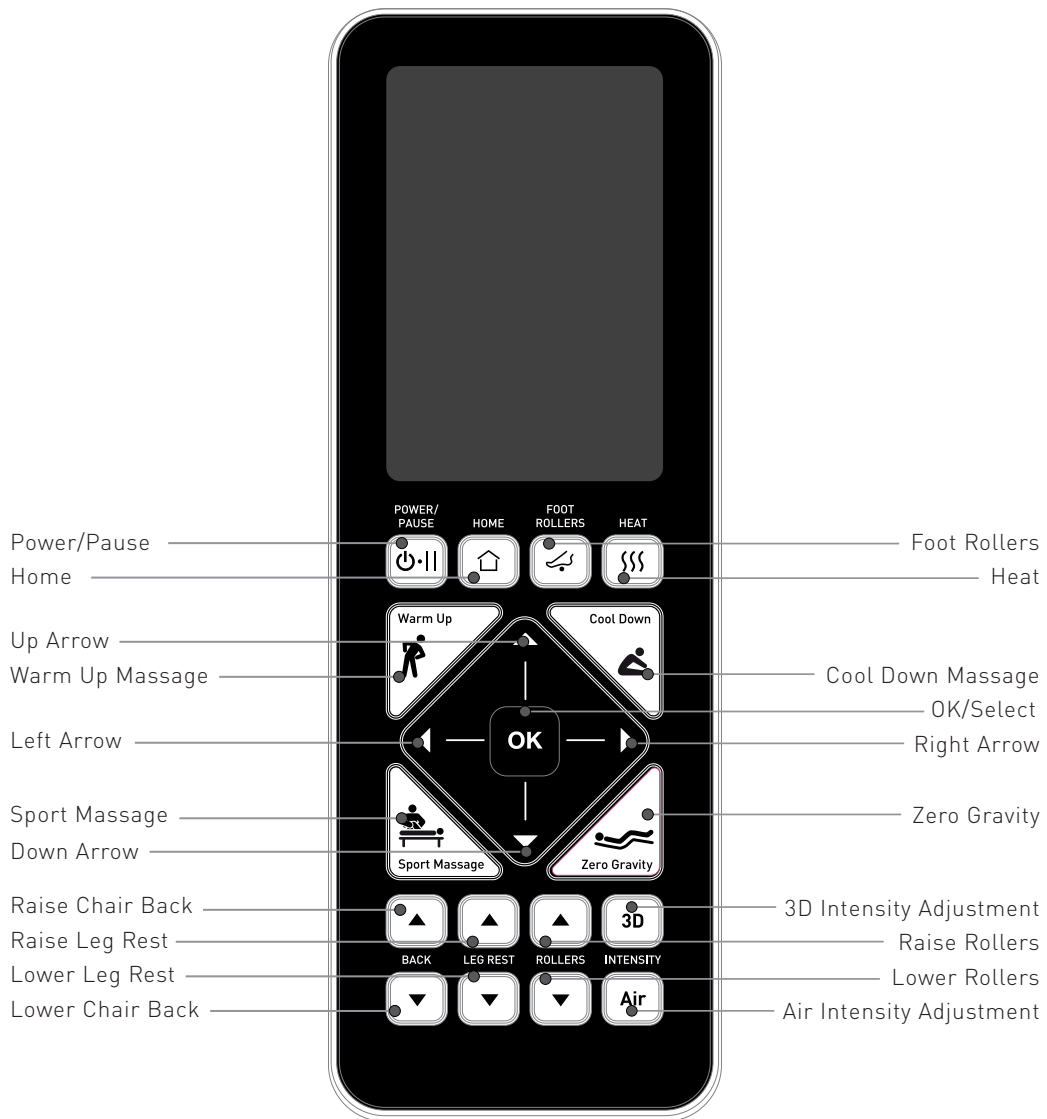



TO AVOID DAMAGE







- Do not sit, step, or place heavy objects on the remote control.
- Do not drop the remote control.
- It is recommended that the remote control be placed in the remote pocket when not in use.
- Do not exert excessive force on the remote control.
- Do not pull the remote control cord forcefully.
- Do not operate the remote control using sharp edged or hard objects.



REMOTE FUNCTIONS

	<ul style="list-style-type: none"> • Press to turn the remote control power on. When the power is off, the remote screen is blank, and the Power/Pause button is not illuminated. When the power is ON, the remote screen shows data and the Power/Pause button will glow white. • Press and hold Power/Pause to turn the remote control power off. Doing this while the chair is activated causes the rollers to return to their storage position, after which the chair turns itself off. • Quickly press and release Power/Pause when you want to pause a massage. During a pause, the button will glow red. When the Power/Pause button is pressed again, the massage will resume from the point the session was stopped.
	<ul style="list-style-type: none"> • Press to access the screen/menu where you can select massage sessions, adjust massage intensity, roller width, settings, and more. • Press this button again to return to the home screen to view a summary of current selections.
	<ul style="list-style-type: none"> • Press to manually turn on and off the foot rollers
	<ul style="list-style-type: none"> • Press to turn the heat on and off. • When the heat is on, this button will glow red.
	<ul style="list-style-type: none"> • Press to activate the programmed Warm Up session. When the Warm Up session is activated, this button will glow white.
	<ul style="list-style-type: none"> • Press to activate the programmed Cool Down session. When the Cool Down session is activated, this button will glow white.
	<ul style="list-style-type: none"> • Press to activate the programmed Sport Massage session. When the Sport Massage session is activated, this button will glow white.
	<ul style="list-style-type: none"> • Press to adjust the reclining angle of the chair into a perfect zero gravity position. The button will glow white when in the zero gravity position. • Press again to sit up.

REMOTE FUNCTIONS

	<ul style="list-style-type: none"> Use the arrows to navigate through the menu(s) on the LCD screen (up, down, left, right).
	<ul style="list-style-type: none"> After navigating to the desired selection within the LCD or home screen menu, press to select/activate the option.
	<ul style="list-style-type: none"> Press to adjust the reclining angle of the chair. To automatically incline or recline the back to its fully upright or extended position, press and hold the corresponding recline button for approximately 2 seconds.
	<ul style="list-style-type: none"> Press to adjust the angle of the leg rest. To automatically raise or lower the leg rest, press and hold the corresponding foot button for approximately 2 seconds.
	<ul style="list-style-type: none"> Press to adjust roller position during a manual massage or to fine tune the shoulder scan position.
	<ul style="list-style-type: none"> Press to change the intensity of the roller massage which can be adjusted in three varying intensities.
	<ul style="list-style-type: none"> Press to change the intensity of the air massage which can be adjusted in three varying intensities.

Choose from eleven programmed and focused massage sessions. Each sessions lasts approximately 15 minutes and, unless otherwise noted, can be selected by navigating through the easy-to-use menus on the remote display. Fitness experts will tell you that a complete workout routine includes more than just exercise itself. A complete routine also cares for the wear-and-tear and minor injuries that naturally occur with strenuous or regular movement. It's now generally accepted that the physiological and psychological benefits of massage make it an ideal complement to a total conditioning program by helping you manage stress, by reducing stiffness and soreness, and by helping you recover more quickly from physical exertion.

Programmed Sessions

Sport Massage

Vigorous roller and air massage actions are combined to maximize blood flow to all the large muscle areas. Back massage and back mobilization help loosen and relax tight muscles, and provide inter-vertebral traction through back extension.

Recovery

Targets the key muscles that an athlete typically uses and encourages blood flow to all the large muscle groups in order speed muscle recovery and reduce post-exertion soreness.

Stretch

Carefully crafted stretching movements including hip rotation and back extension. Designed to help stretch and loosen the muscles of the entire body.

Core Rotation

Designed to mimic twisting and stretching movements important for an athlete's warm up and cool down activity, this massage will combine the use of air cells and the massage mechanism to twist both the body's upper and lower body.

Warm Up

This massage session prepares your body for exercise. It's characterized by gentle massage movements, gentle stretching, mobilization movements to loosen your back and peripheral air massage to encourage blood flow to your calves and arms.

Cool Down

Add to your post-exercise glow with this light and gentle cool down routine. Cool Down combines a series of massage movements organized to decrease swelling, help clear away toxins and relieve tense, stiff muscles.

Visualize

Place yourself in the perfect state of mind for peak performance. Close your eyes, imagine having a great workout, and let this session's methodical and rhythmic pacing take you to a place of confidence and strength.

Full Body Air

A comprehensive, full body massage program designed to energize your entire body and calm your mind.

SESSIONS

Focused Sessions

Neck & Shoulders

Focused kneading massage around the neck and shoulders designed to help loosen the muscles of the upper back.

Low Back

Encourages blood flow to this very typical problem area for active adults and mobilize and stretch your low back with this focused session.

Glutes & IT Band

The perfect session for runners. Works the IT bands and the glutes.

Manual Sessions

This chair has 7 manual massage methods from which you can choose: Knead, Delta Knead, Tap, Pulse, Knead & Tap, Knead & Pulse, and Rolling.

Manual Air Sessions

This chair has 4 manual air sessions from which you can choose: Shoulder & Arm, IT Band, Legs & Feet, & Full Body Air.



TO AVOID INJURY

Always check your surroundings before beginning a massage to ensure that no people, pets, or objects will be hit or squeezed by the reclining back or leg rest.



TO AVOID DAMAGE AND INJURY

- This massage chair is meant to be used for indoor household use only. The chair is not designed for commercial purposes.
- If you use the chair in a cold room, do not increase the temperature abruptly. Instead, increase the temperature gradually to a normal level.
- If the chair is stored in a cold place and is moved into a warm environment, wait one hour before use. Otherwise, performance may suffer, or the chair may malfunction due to condensation on the mechanism.
- Do not sit on the chair with the leg rest raised. Sudden heavy weight on the leg rest could cause damage to the mechanism, or it may result in accident or injury.
- Ensure the back rest returns to the upright position before sitting.
- Do not use the arm or shoulder unit for any area other than your arms and shoulders.
- If your arm comes out of the arm or shoulder unit or your leg/foot come out of the foot rest during a massage, do not try to force it back in.
- Do not massage your elbows.
- Do not put anything other than legs and feet in or on the foot rest.

OPERATION & USE

Positioning Yourself in the Chair

- When the chair is off, the rollers are stored in the top of the back rest. This is known as the storage position. If the rollers are not in the storage position, simply reset by pressing the Power button on the remote control before sitting on the chair.
- Sit back fully in the chair so your entire back is against the back rest and your head is leaning into the pillow.
- Adjust the head rest so it sits just above your shoulders and at the base of your neck. If the pillow is positioned too high or too low, the automatic acupressure point detection will not work correctly (see right).
- Adjust the shoulder air cell by rotating it up or down until comfortable.

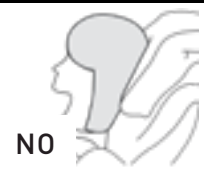
HEAD REST POSITIONING	
YES 	NO 
The head rest position matches the back of the head	The position of the head rest is too high

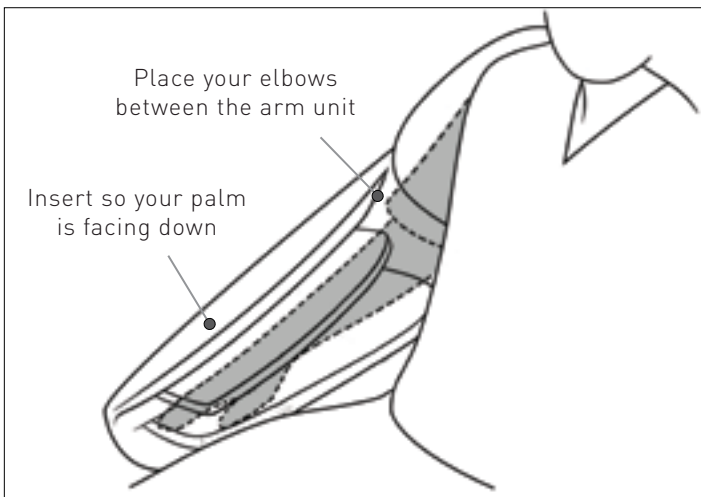

Place your arms in the arm unit, palms down.

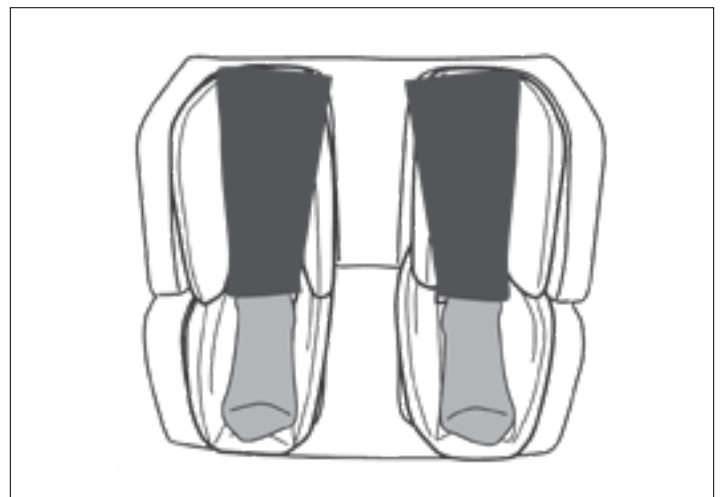

Place your feet in the leg rest.

NOTE: When the leg rest raises, press out with your feet and the leg rest will adjust to the appropriate length (see below).





TO AVOID INJURY

- If you feel the massage is too strong, reduce the stimulation using the Massage Intensity button as described earlier in this manual. If the massage remains too strong, stop operation immediately.
- Do not place hands or feet into the roller tracks, into the space between the seat and back, or into the moving parts.
- Do not sit wearing hard objects, such as hair accessories or jewelry.
- Keep massage sessions to no more than 30 minutes in length. Do not exceed 5 minutes for an area-specific massage for any part of the body.

Retrieving & Storing the Remote

- The remote should be stored in the pocket on the inside of the right arm (when sitting) of your chair.
- To retrieve the remote, gently pull out of the remote pocket.
- To return the remote to its storage slot, gently push into the remote pocket.

Powering On

- Press the Power/Pause button to turn the remote control power ON. When the power is ON, the remote screen shows the main menu and the Power/Pause button will glow white.

Powering Off

- Press and hold the Power/Pause button for 3 seconds to turn the remote control power OFF. When the power is OFF, the remote screen is black/blank, and the Power/Pause button will glow red.
- If the chair has been in a reclined position it will automatically restore to the upright position when powered off.

NOTE: The remote power will automatically turn off after approximately 15 minutes of inactivity.

NOTE: The Power/Pause button on the remote is not the Main Power switch. See page 13 for Main Power.

OPERATION & USE

Starting a Massage

- Ensure remote power is ON. The Power/Pause button will glow white.
- Use the Remote navigation arrows to scroll through the menus. As you navigate the menus, the black highlight indicates where the cursor is within the menu.
- Once your desired selection is highlighted, press the OK button to activate the selection.
- Upon activation, a blue dot will appear to the right of the currently running selection(s), and the upper section of the remote screen will display the name of the massage(s) selected. The timer in the upper right corner indicates estimated massage duration.
- Choreographed massages that automatically combine the massage mechanism, air massage, and other features, are offered in the Programmed & Focused menus (except in Full Body Air, which is an air massage only program).
- Manual menu options activate a specific back mechanism function or set of functions.
- Massages within the Manual Air menu are those that activate only the air cells.

Shoulder Scan & ScanSave

To experience a massage as intended, it is extremely important to define the shoulder position prior to the start of a massage session. To ensure massage accuracy, please follow the steps below:

When the head pillow is properly placed...

- The massage chair will Auto-Detect shoulder position.
- Fine Tune Shoulder Position: Once Auto-Detect is complete, the remote will beep, the roller buttons glow white, and the help text "Use roller buttons to fine tune shoulder position now" appears at the bottom of the screen. Roller position can be adjusted by pressing and holding the Roller Up or Down arrows until the mechanism is located in the proper position at the tops of the shoulder.

NOTE: Ensure you are not sitting on the bottom edge of the back pad. If this pad is too tight against the back, the shoulder scan will not work properly.

When the head pillow is not properly placed OR not being used...

- ScanSave remembers your body profile for all massages performed during the same power cycle. The chair will only scan once while powered on, upon the first Programmed or Focused massage selection. If a second program is selected the scan from the first program is remembered and used for the new selection. Anytime a new user enters the chair, the remote, if it has been left on from a previous user, should be powered off and back on to ensure that the new user is properly scanned.

NOTE: Fine Tune Shoulder Position lasts approximately 15 seconds before the shoulder position is stored and used for all massage choreography.

NOTE: Shoulder scan detection does not occur when selecting Manual or Manual Air massages.

Massage Mechanism Intensity Adjustment

Feature available with all Programmed (excluding Full Body Air), Focused, and Manual massages

The degree of pressure felt from the massage mechanism, can be adjusted between low, medium and high by pressing the 3D button on the remote or by adjusting intensity the menu settings of the selected massage.

The default setting is medium.

Using the 3D button on the remote...

- Press and release the button once to go from medium to high intensity. Press again to go from high to low intensity. Press a third time to go from low to medium intensity. Repeat as desired.

Using the menu settings of the selected massage...

- If not already there, press Home/Menu to access the Main Menu. Use the navigation arrows, located in the center of the remote, to navigate to the active program, then use the right arrow to get to 3D intensity adjustments. Once the desired intensity level is highlighted, press OK to select.

NOTE: When low intensity is selected the 3D button will glow green, when medium intensity is selected the button will glow yellow, and when high intensity is selected the button will glow red.

NOTE: Users in excess of 200 lbs (91kg) may cause the chair to malfunction. This can be prevented by avoiding the highest 3D intensity setting.

Massage Mechanism Speed Adjustment

Feature available with all Manual massages (excluding Rolling).

Speed, or the pace at which the massaging movements of the massage mechanism occur, can be adjusted between ultra slow/low, medium and fast (within the menu settings of the selected massage). The default setting is medium.

To adjust Speed using the menu settings of the selected massage...

- If not already there, press Home/Menu to access the Main Menu. Use the navigation arrows, located in the center of the remote, to navigate to the active program, then use the right arrow to scroll to Speed adjustments. Once the desired speed is highlighted, press OK to select.

NOTE: Additional Speed options are available when Knead & Tap is selected. Combo 1 combines fast kneading and slow tapping, while Combo 2 combines slow kneading and fast tapping.

OPERATION & USE

4D Speed Adjustment

Feature available with all Manual massages

4D Speed, or the speed at which the massage mechanism moves up and down the body, can be adjusted between Low, Medium and High within the menu settings of the selected massage. Note the default setting for 4D Speed is Medium.

To adjust 4D Speed using the menu settings of the selected massage...

- If not already there, press Home/Menu to access the Main Menu. Use the navigation arrows, located in the center of the remote, to navigate to the active program, then use the right arrow to scroll to 4D adjustments. Once the desired speed is highlighted, press OK to select.

Width Adjustment

Feature available on the following Manual massages: Tap, Pulse, Rolling

Width, or the distance between the rollers on the massage mechanism, can be adjusted between narrow, medium and wide within the menu settings of the selected massage. Note the default setting is Medium.

To adjust Width using the menu settings of the selected massage...

- If not already there, press Home/Menu to access the Main Menu. Use the navigation arrows, located in the center of the remote, to navigate to the active program, then use the right arrow to scroll to Width adjustments. Once the desired width is highlighted, press OK to select.

Coverage Adjustment

Feature available on all Manual massages

Coverage, or the area of the body that is massaged, can be adjusted between Point (massages a particular point of the body), Partial (massages a small area approximately 6" [15.25 cm] in length) and Full (massages the entire body) within the menu settings of the selected massage. Note the default setting for Coverage is Full.

To adjust Coverage using the menu settings of the selected massage...

- If not already there, press Home/Menu to access the Main Menu. Use the navigation arrows, located in the center of the remote, to navigate to the active program, then use the right arrow to scroll to Coverage adjustments. Once the desired area is highlighted, press OK to select.
- When coverage selection is Point, use the up/down Roller buttons to move the massage mechanism to your desired location. The up arrow will move the rollers up the back toward the shoulders, while the down arrow will move the rollers down the back toward the glutes.
- When coverage selection is Partial, the up/down Roller buttons will adjust the area massaged. To massage an area closer to the shoulder, press the Roller Up arrow. To massage an area close to the glutes press the Roller Down arrow.

Foot Roller Use & Adjustment

During Programmed & Focused Messages...

- Some Programmed and Focused massages activate the Foot Roller function intermittently throughout the massage session. If you wish to cease this movement during the selected session, you can do so by pressing the Foot Roller button located on the top of the remote. If you wish to reactive the movement, press the Foot Roller button again. You will feel a quick foot roller movement to indicate it's reactivation, but the feature will then only activate as designed intermittently throughout the program.

NOTE: If Foot Rollers are not programmed during the selected massage, you will not be able to activate this feature. Should you try, the remote will beep indicating an error.

NOTE: When the button is illuminated the feature is active, when the button is not illuminated the feature is off.

As a Manual Massage...

- Foot Rollers can be activated as a manual massage by pressing the Foot Roller button located at the top of the remote.
- If Foot Roller movement is desired, but intensity is too strong, place the foot roller buffer pads (included in the accessory box) in the foot pockets of your chair before your feet are placed for a massage.

Chair Angle Adjustment

During Programmed and Focused massages, the chair will automatically recline to the suggested position for the massage. If a different reclining angle is desired you can adjust by the following:

- **Back Position Adjustment:** To recline the angle of the chair's back, press and hold the Back Down button until the desired position is reached. To incline the angle of the chair's back, press and hold the Back Up button until the desired position is reached. Note adjusting the back position also automatically adjusts the leg position.
- **Leg Position Adjustment:** To recline the angle of the chair's leg, press and hold the Leg Down button until the desired position is reached. To incline the angle of the chair's leg, press and hold the Leg Up button until the desired position is reached.

NOTE: If you press a back or leg up/down button for longer than 2 seconds, the remote will beep indicating that the chair will automatically recline/incline to its furthest position. If you wish to interrupt the movement, press the back or leg up/down button again.

- **Brio Sport Preset Positions:** The remote includes a button, Zero Gravity, that allows quick and easy movement into the preset Zero Gravity position, as well as the Restore/Upright position. To move the chair into these positions, press the Zero Gravity button located on the center of the remote. When the button is not illuminated, the first press will go to Zero Gravity, the second press will restore the chair to a full and upright position.

NOTE: If the button is illuminated, the chair is in the Zero Gravity Position.

OPERATION & USE

Roller Position Adjustment

During Programmed & Focused Messages...

Roller position cannot be adjusted after the scan is complete.

During Manual Air Messages...

If the roller is sitting in a position which is uncomfortable, you can adjust its location by using the up/down roller buttons to move the massage mechanism to your desired location. The up arrow will move the rollers up the back toward the shoulders, while the down arrow will move the rollers down the back toward the glutes.

Combining Manual & Manual Air Messages

- A Manual massage method may be combined with an air massage.
- To activate air massage with a manual massage, if not already there, press Home/Menu to access the Main Menu. Use the navigation arrows, located in the center of the remote, to scroll to the desired Manual Massage, press OK to select. Then use the navigation arrows to scroll to the desired Manual Air Massage, press OK to select.

NOTE: Only one manual and one air method can be combined at any one time.

Heat

- The chair is equipped with heat in the rollers, seat and calf. Heat can be enjoyed on its own, or during any massage session.
- To turn heat on, press the Heat button on the remote. When heat is on, the button will illuminate red.
- To turn heat off, press the Heat button a second time. When heat is off, the button will not be illuminated.
- If heat is desire in only select zones, this can be adjusted by, if not already there, pressing Home/Menu to access the Main Menu. Use the navigation arrows, located in the center of the remote, to scroll to settings in the Main Menu, then scrolling right to Heat Zones. Then use the navigation arrows highlight the zones which you'd like to deactivate/activate. Press OK to change from ON to OFF and back again. A blue dot next to the zone name indicates ON, a clear dot indicates OFF.

NOTE: Heat automatically turns on with all programmed and focused programs excluding Cool Down.

Link Another Message

- To enjoy two massages back-to-back and without interruption, you can link a second message to your first message selection. When the first massage completes, the second message will immediately begin.
- To link, use the navigation arrows located in the center of the remote to navigate to the active program. Then use the right arrow to scroll to "Link Another..." Press OK. You should now be in the Link Another Message menu.

- A list of linkable messages will appear. Use the down/up navigation arrows to view the messages and press OK when the message you wish to link is highlighted.
- The title area of the remote will update to reflect that your message has been linked.
- To change or remove the linked message simply navigate your way back to the Link Another Message menu and press OK on your desired selection.

NOTE: Linking another message is only available within Programmed and Focused messages.

Pausing a Message

- To pause a message, quickly press and release the Power/Pause button. Upon doing this the massage mechanism will immediately cease all movement, the chair angle will remain in the exact position it was when the button was pressed, and the Power/Pause button will flash red.
- To resume the message, quickly press and release the Power/Pause buttons again. Upon doing this the Power/Pause button will illuminate in white, and the massage will resume from where it was stopped.

Ending a Message

- To end a message in the middle of an active session, you can do one of the following:
- Press the Home/Menu button to access to the Main Menu, then use the navigation arrows to navigate to End Message. Once End Message is highlighted, press OK and the message will cease; the massage mechanism will slowly move to its storage position (upper shoulders). Please note, the chair will remain in the reclined angle. This option leaves the chair powered on so another message may be selected.
- Press and hold the Power/Pause button for 3 seconds. This action will end the session by powering off the chair. The massage mechanism will slowly move to its storage position (upper shoulders) and, if the chair has been in a reclined position, it will automatically incline to the upright position.

NOTE: Messages will automatically stop after approximately 18 minutes of activity. The chair will remain reclined.

NOTE: Never get out of the chair without first returning it to its full upright position.

NOTE: Never press on shoulder, or stand on foot rest to get out of chair.

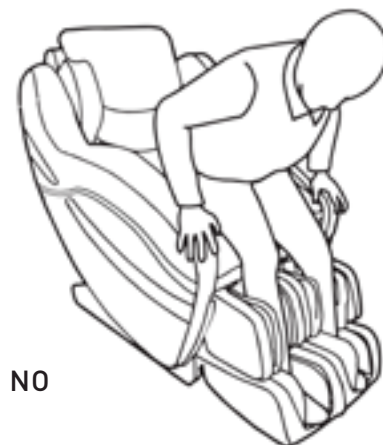

OPERATION & USE

Removable Lower Back & Foot Buffer Pads

- The chair comes with Foot Buffer pads in the accessory box. The foot buffer pads should be placed in the foot beds if the user finds the foot roller massage too intense. *(See Figure X)*
- The chair comes with a Lower Back Buffer pad in the accessory box. The low back buffer pad should be placed between the back of the chair and the back pad if the user finds the low back massage too intense. *(See Figure Y)*

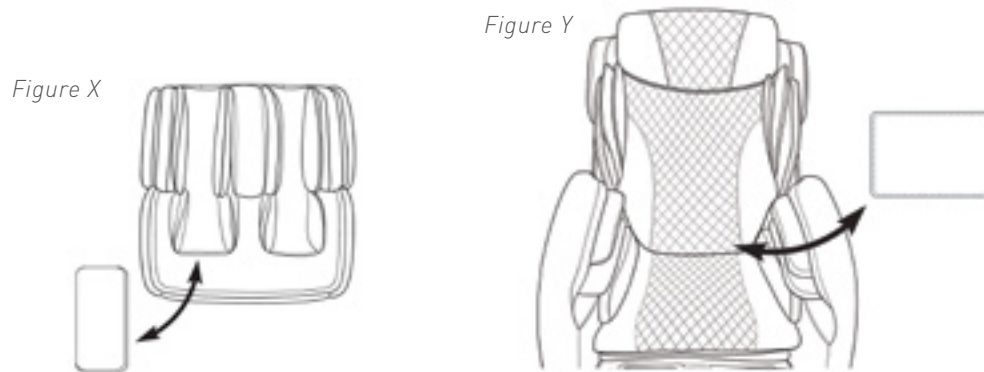

Sound

- The remote can be set up to either beep or remain silent with each button press. To change the Sound setting, if not already there, press the Home/Menu button to access to the Main Menu. Then use the navigation arrows to navigate to Settings, scroll right to access Sound, press OK to turn the Sound on. Press again to turn the Sound off. When on, a blue dot will appear to the right of the listing, when off, the dot remains clear.

NOTE: The default setting is Sound Off.

Chromotherapy

- For additional sensory relaxation, the remote is programmed to be able to display chromotherapy sessions when powered on and the remote has been idle for 90 seconds.
- To change the Chromotherapy setting, if not already there, press the Home/Menu button to access to the Main Menu. Then use the navigation arrows to navigate to Settings, scroll right to access Chromotherapy modes. Once desired setting is highlighted, press OK to preview. Press OK a second time to select. A blue dot will appear to the right of the selected mode.

NOTE: The default mode is Off.

Reading the Remote Home Screen



- ① The selected program(s) names will appear in this place.
- ② The darkened bars indicate your selection.
1 bar = Low, Ultra Slow/Slow, Narrow 2 bars = Medium 3 bars = High, Fast, Wide
- ③ The darkened word indicates your coverage selection.
- ④ The darkened word(s) indicated zones of heat that are activated.
- ⑤ Scrolling tip text helps guide you through the massage chair usage.
- ⑥ When a program begins, the length of the program appears in the center. The circle will go from green to grey as time passes.
- ⑦ When these icons appear in color, the feature is activated. When they appear in greyscale, they are not activated.

OPERATION & USE

Language

The remote can be set up to display in multiple languages. To change the Language setting, if not already there, press the Home/Menu button to access to the Main Menu. Then use the navigation arrows to navigate to Settings, scroll right to access Language options. Once desired language is highlighted, press OK to select. All remote copy will display in the desired language.

About

Service contact information, as well as data about the chair, which may be helpful should you call for service, is located within the About menu. To view this information, if not already there, press the Home/Menu button to access to the Main Menu. Then use the navigation arrows to navigate to Settings, scroll right to access the About menu.

Storage

- After every use, turn off the main power switch located on the back of the chair and unplug the power cord from the wall outlet.
- When not in use, the chair should always be stored in its full upright position (back rest fully inclined, foot rest to its lowest position).
- The chair should be stored in a place of low humidity.
- Do not store the chair in direct sunlight or in places of high temperature. This may cause the color of the upholstery to fade.

Cleaning & Care



TO AVOID INJURY

- Before cleaning, always unplug the power cord from the wall outlet.
- Never clean the chair or remote with wet hands.



TO AVOID DAMAGE

- Before cleaning, always unplug the power cord from the wall outlet.
- Never clean the chair or remote with wet hands.

- Use a soft, dry clean cloth to wipe dust off of upholstered surfaces and the remote control.
- For spots on the fabric, dampen a soft, clean cloth with warm water and a mild detergent, then gently rub. Finish with a soft, dry clean cloth.

TROUBLESHOOTING

Troubleshooting Guide

If you encounter problems with the operation of your massage chair, please check the following points to see if they can be easily rectified. If the chair still malfunctions or does not work, please turn off the main power switch and remove the power plug from the wall outlet.

Contact Positive Posture for service. Do not dismantle or attempt to repair the chair yourself.

Doing so will void the warranty.

Problem: My chair doesn't work after powering on.

Possible Cause & Solution:

- Ensure the chair is securely plugged into the wall outlet.
- Ensure the main power switch on the back of the chair is switched to the ON position.
- Ensure the remote control and power cord are fully installed.
- Ensure the remote power is on by pressing the Power button on the remote.
- Ensure a massage session has been selected by pressing any programmed or manual massage button on the remote.
- Other issues may include the wires or plug being damaged, the fuse having burned out, or an issue with the inner circuit. Call Positive Posture for service.

Problem: My chair makes a beeping sound during the massage.

Possible Cause & Solution:

- This sound is normal. There is no cause for concern.

Problem: My chair is very noisy.

Possible Cause & Solution:

- There are many sounds made by the massage chair that are normal. This includes noise during tapping, the sound of the rollers rubbing against the seat covering while kneading, the sound of the rollers moving up and down the track, the sound of the ionizer running, and the sound of the air pump and the air bags inflating and deflating. If you hear sounds other than this, or the sounds suddenly become different/louder, please call Positive Posture for service.

Problem: The left and right rollers are out of alignment.

Possible Cause & Solution:

- The rollers are designed to work independently, so in the stopped position they are sometimes out of line. This is part of the design and is normal.

Troubleshooting Guide, continued...

Problem: The rollers suddenly stopped in the middle of a session.

Possible Cause & Solution:

- The chair may have lost power. Turn off the main power switch, unplug from the wall, then reinsert the power cord into the wall outlet and turn on the main power switch.
- Ensure the massage session didn't complete its cycle by using the remote to select a new massage session.
- Sometimes when there is too much pressure on the rollers, they can stop moving temporarily. To test this, slightly lift your body or slightly raise the reclining seat back.

Problem: The back rest or leg rest will not go down entirely.

Possible Cause & Solution:

- Ensure there are not any objects blocking its path.

Problem: The acupuncture point detection is not working properly.

Possible Cause & Solution:

- Ensure you are sitting still during the shoulder scan. If you wiggle or move around, you can trigger a false reading.
- Ensure the back pad is not bunched or folding over itself in any part of the back
- Ensure you are not sitting on the bottom of the backpad. When this is too tight against the back of the chair, it can cause the scan to not work properly.
- Try sitting further back in the chair so that your head rests firmly on the head rest. You can also adjust the shoulder position with the Roller buttons immediately after the acupuncture point detection is complete.

Problem: The power cord or plug is abnormally hot.

Possible Cause & Solution:

- Stop using the chair immediately. Turn off the main power switch and remove the power plug from the wall outlet. Call Positive Posture for service.

Problem: My remote control is displaying Er# in the tip text area and wont stop beeping.

Possible Cause & Solution:

- Something went wrong. Power off the chair using the remote. Turn off the main power switch and unplug the chair from the wall. Then re-insert the power cord and turn on the main power switch. Turn on the chair using the remote's power button. Continue use like normal.
- If the problem persists, please contact Positive Posture service for further assistance.

TROUBLESHOOTING

Troubleshooting Guide, continued...

Problem: The back rest or leg rest will not go down entirely.

Possible Cause & Solution:

- Ensure there are not any objects blocking its path.

Problem: My chair does not incline when I use the back up button.

Possible Cause & Solution:

- The chair is a wall-hugging device; to accommodate this feature the track base slides along itself. It is possible to recline the chair (using the back down button) past the maximum point of recline. When this occurs, it will not appear that the chair is righting itself when the back up button is pressed.
- Press and hold the back up button for approximately 2 seconds until a beep is heard. Wait a full minute; the chair should return to its upright position within this time.
- If the problem persists, turn off the main power switch and unplug the chair from the wall. Then re-insert the power cord and turn on the main power switch. The chair should return to its upright position.
- If the chair does not, turn the power on with the remote power button, then turn the power off with the remote power button. The chair should return to its upright position.
- If the problem persists, please contact Positive Posture service for further assistance.

Problem: My remote screen is displaying a strange solid color.

Possible Cause & Solution:

- Congrats! You found the chromotherapy feature. Enjoy the soothing color patterns the remote can produce.
- When enabled, chromotherapy will activate after 90 seconds of remote control inactivity.
- To disable or change color pattern, navigate into settings and then chromotherapy settings. Once inside the chromotherapy settings menu select Off.

Troubleshooting Guide, continued...

Problem: The pillow is too high/too low.

Possible Cause & Solution:

- Simply push up or pull down on the pillow to change its position.

Problem: My remote is no longer in my desired language.

Possible Cause & Solution:

- The language setting was changed. To again select your language of desire, go to the main menu, scroll down to the 5th menu option, press OK, then scroll down to the 4th menu option, press OK. You should now see your desired language setting.

Q: Can I put the chair on a wood floor?

A: Yes. However, because the chair could damage the floor surface we recommend laying a carpet or something similar under the chair.

Q: I spilled water on the chair. What should I do?

A: There is danger of electric shock. Stop using the chair immediately and do the following:

- Turn off the main power switch on the back left of the chair.
- Unplug the power from the wall outlet.
- Contact Positive Posture for assistance.

Q: How do I make the massage stronger?

A: Try any of the following things:

- Use the 3D button to select maximum pressure.
- Sit back further in the chair so that your weight is against the reclining seat back.
- Lower the reclining seat back.

Q: How do I make the massage softer?

A: Try any of the following things:

- Use the 3D button to select minimum pressure.
- Raise the reclining seat back.

WARRANTY & AFTER SALES SERVICE

Warranty

We're confident that your new massage chair will provide you with many years of relaxation and trouble-free performance. Your Positive Posture massage chair comes with a 3-year limited warranty, and (for an additional fee) a five year extended warranty is also available. Our limited warranty includes on-site service covering all parts and labor in most locations in the United States and Canada. Some restrictions apply. See www.PositivePosture.com for full warranty details. We recommend that you print the limited warranty information at the time of purchase and keep it with your Owner's Manual.

Service & Repairs

Before calling for repairs or service, please consult the Troubleshooting Guide on page 43. If the problem persists, contact Positive Posture for assistance. For fastest service, please have the following information ready:

- Your name, email, address & telephone number
- Model Number (see the specification field on the front cover of this Owner's Manual or review the sticker affixed to the back base of your chair)
- Serial Number (see the sticker affixed to the back base of your chair)
- Copy of original receipt and purchase Date
- Malfunction or issue with as much detail as possible

Note: We typically maintain an inventory of service parts (except fabric) for 5 years after terminating production of the model. The service parts are those necessary to maintain function of the chair.

SPECIFICATIONS

Model Name	Brio Sport
Model Number	PP7913A
Power Supply	AC120V ~ 60Hz
Power Consumption	200W
Rated Time	30 minutes
Kneading Speed	From 11 times/minute to 35 times/minute
Tapping Speed	From 87 times/minute to 492 times/minute
Up/Down Speed	From 54" (137 cm) per minute to 106" (269 cm) per minute
Back Stroke Range	49" (124 cm)
Preset Sessions	11 sessions
Manual Sessions	7 sessions plus Foot Rollers
Air Pressure	Approximately 32 kPa
Program Timer	Approximately 18 minutes
Foot Rest Adjustment Range	Approximately 7" (17.75 cm)
Reclining Angle	Approximately 123° to 157° against flat floor
Chair Dimensions	Upright: 59" (150 cm) L x 33.5" (85 cm) W x 48" (122 cm) H Reclined: 80" (203 cm) L x 33.5" (85 cm) W x 38.25" (97 cm) H
Seat Width	17" (43 cm)
Seat Depth	18.5" (47 cm)
Chair Weight	251 lbs (114 kg)
Outer Cover	Synthetic Leather
Supplied Items	Power cord, T-shaped wrench, cap head screws, straight pins, cotter pins, channel covers, carry handles, foot buffer pads, lower back buffer pad
Shipping Dimensions	Box 1: 60" (152 cm) x 30" (76 cm) x 33" (84 cm) Box 2: 57" (145 cm) x 21" (53 cm) x 35" (89 cm)
Shipping Weight	Box 1: 196 lbs (89 kg), Box 2: 121 lbs (55 kg)
Recommended User Weight	265 lbs (120 kg) (maximum)
Recommended User Height	5' 0" (153 cm) to 6' 5" (198 cm)

BRIO

SPORT

by  POSITIVE POSTURE®

Your massage chair was meticulously designed to conform to your specific comfort and relaxation needs. If you have questions about the operation of your massage chair, contact information for a Positive Posture chair expert can be found at www.PositivePosture.com.

Positive Posture. A division of FFL Brands.

© 2020 Positive Posture
Boulder, Colorado | USA
www.PositivePosture.com