

# **SWIFT HITCH®** *More Than a Hitch Up Camera*

## **User Manual**

**Model:SH04 Portable WiFi Camera**

Viewed by smartphone or tablet

Support night vision

Water resistant

Support outdoor and indoor use

Support dual power source: 5VDC / 12VDC



Please read carefully and thoroughly this manual before any attempt to operate this product and keep it for your future reference.

<b>INTRODUCTION</b>	<b>1-2</b>
Warranty	1
Restrictions	2
Maintenance	2
<b>PRODUCT</b>	<b>3</b>
Included Parts	3
Camera Illustration	3
<b>HOW TO USE</b>	<b>4-9</b>
Charging Camera	4
Download Free APP: Swift WiFi Cam	5
Power On Camera	5
Link Camera	5-7
Mount Camera	7
Mount Magnetic Holder for Smart Phone (Optional)	8
View Camera	8
How to use tether for the camera (Optional)	9
<b>MAIN FUNCTIONS OF CAMERA</b>	<b>10</b>
<b>MAIN FUNCTIONS OF APP</b>	<b>11-14</b>
Switch between STA Mode and AP Mode	11-12
Turn On/Off IR LED and Guide Line	13
Video Parameter Setting	13
Video and Image Control	14
Camera Low Battery Alert	14
<b>ADVANCE FUNCTIONS OF APP</b>	<b>15-17</b>
Push Notice	15-16
Mail Settings	16-17
User Name and Authorization Setting	17
<b>SPECIFICATIONS</b>	<b>18</b>
<b>TROUBLE SHOOTING</b>	<b>19</b>
<b>APPROVAL INFORMATION</b>	<b>20</b>

# INTRODUCTION

Thank you for purchasing this wireless camera kit. This product works at 2.4GHz frequency band which can be legally used worldwide without permission. We feel confident that you will be pleased with the quality and features of this product. The camera use CMOS sensor to capture the image and transmits the image to your smart phone by WiFi. Its image is much more stable than analog 2.4G or 5.8G wireless camera.

The receiver can be any type of smart phone or tablet with Android/iOS system.

## **Warranty:**

This product has a one year limited warranty with an effective date of purchase. Before contacting customer support please read the trouble shooting section for help first. When call us, please retain sales receipt for purchase verification. Any unauthorized disassemble of the product will void the warranty. DO NOT return warranty products to the retailer such as Amazon.

## **Restrictions:**

1. DO NOT use this product to violate one's privacy. Monitoring one's activities without consent is illegal and this product is not designed and manufactured for such purposes.
2. DO NOT put this product near any medical equipment. Radio waves might potentially cause breakdown of electrical medical equipment. So this product should be placed at least 1 foot away from any heart pacemaker. Radio waves might potentially influence the heart pacemaker and lead to respiratory disturbance.
3. DO NOT use this product for any illegal activities. We are not be responsible for any consequences of illegal acts committed by the user.
4. It is recommended to fix the camera on the vehicle if using it on bumpy road or drive for long time. The screws of fixing camera base can be found inside the package of products.

## **Maintenance:**

1. Do not shake or strike the product.
2. Keep product away from heat sources such as electric heaters.
3. Do not use the camera near corrosive chemicals.
4. Do not use the camera in the places which are enclosed by metal.
5. Please obey the local government's environment protection policy.
6. Please turn off the power when not in use.
7. Do not disassemble or repair the camera without professional guide. Doing so might cause damages to the product and VOID THE WARRANTY.

# PRODUCT

## Included Parts:

This package comes with the following items. Please check whether they are all included in the packaging box. If there is missing part, please contact the retailer for replacement.

- ① Camera x1
- ② AC power charger x1
- ③ USB charging cable x1
- ④ Power extension cable x1
- ⑤ Magnet holder for phone x1
- ⑥ Screw set for camera x1
- ⑦ User manual x1
- ⑧ Quick start guide x 1
- ⑨ Tether for added security x 1



**Notice:** Accessory parts can be found under the top foam.

## Camera Illustration

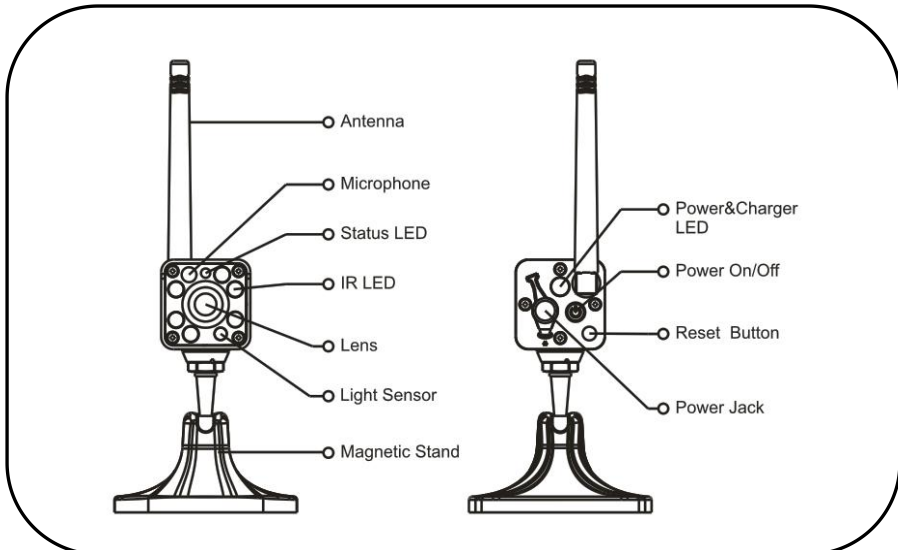

# HOW TO USE

## 1. Charging the Camera

There are three ways to charge the camera build-in battery before using camera.

- 1) Charge the camera build-in battery via AC adapter by connecting USB charging cable between AC adapter and camera. Wall outlet can have output of AC between 100V~240V, adapter output is 5VDC to camera.
- 2) Charge the camera via automotive battery by connecting power extension cable between battery and camera. Power extension cable has fork terminals for easy connection. Battery output is 12VDC.
- 3) Charge the camera with automotive cigarette lighter charging adapter which can have standard 5VDC output or 12VDC output. (Cigarette lighter charging adapter is not included)

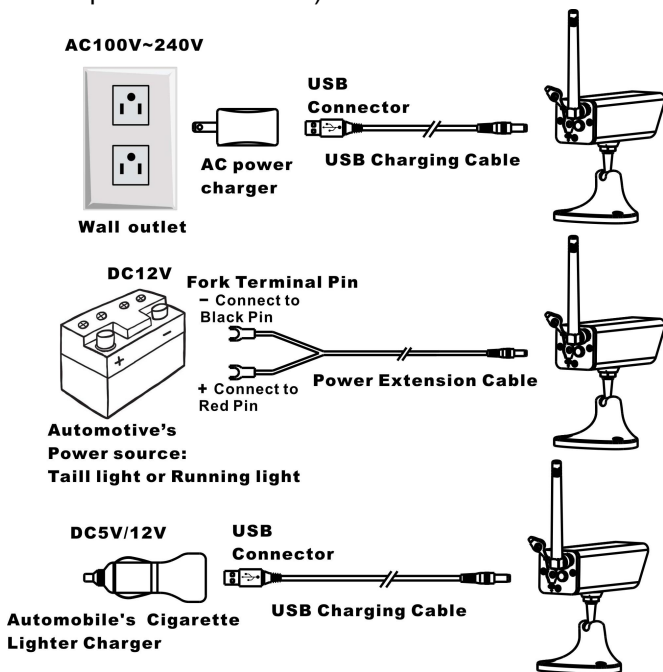

When camera starts to take charge, LED indicator on camera back become red, full charge normally take 5 hours. Once camera is fully charged, LED indicator will go off

## 2. Download Free APP: Swift Wifi Cam

You can search Swift WiFi Cam in App Store for iPhone Or Google Play for Android . (Or scan the QR code below with APP such as Quick Scan to download the APP)



## 3. Power On Camera

Press the Power button to turn on the camera, Power LED(green) will be on,then you can use it.

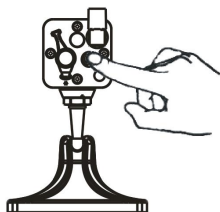

Notes: If the battery is exhausted, please recharge it with the charging cable.

## 4. Link Camera

1) Turn on the wifi option on cell phone first and select camera's wifi ID: SWIFTCAM\_xxxxxx. After selection, leave the password space blank. There is no password needed. (FIG-01)



FIG-01

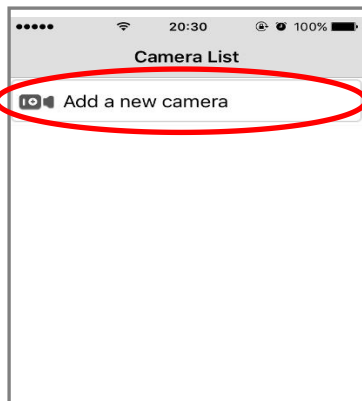

FIG-02

- 2) Run downloaded APP on smart phone
- 3) Tap on “Add a new camera” icon to add the camera (FIG-02).
- 4) Search camera by Taping on “Search in LAN“(FIG-03).

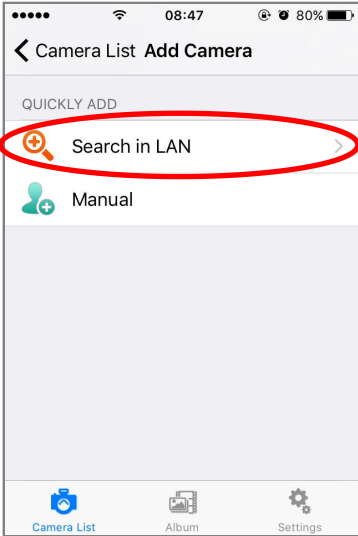

FIG-03

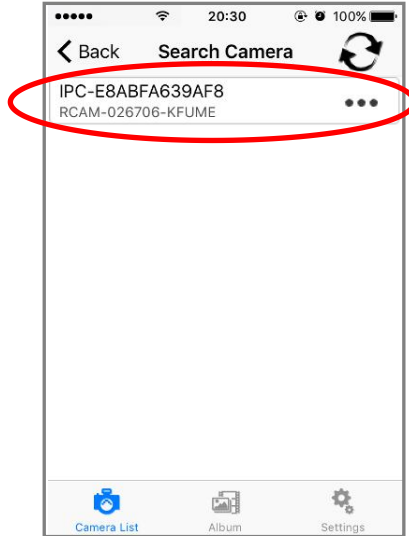

FIG-04

- 5) Camera will be found and displayed with ID code. (FIG-04)
- 6) Tap on the ID code and enter the “Save Camera” page. You can edit your camera name here and then Tap on “Save “(You can leave password blank) (FIG-05), and you will see the “Camera List” page. (FIG-06)

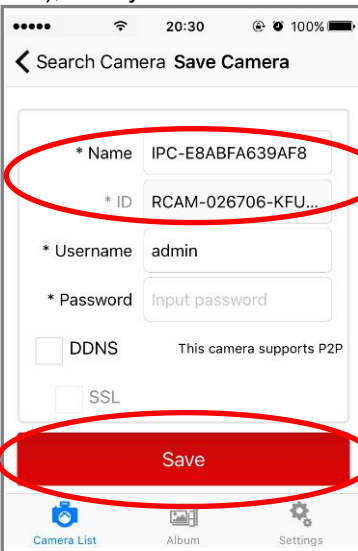

FIG-05

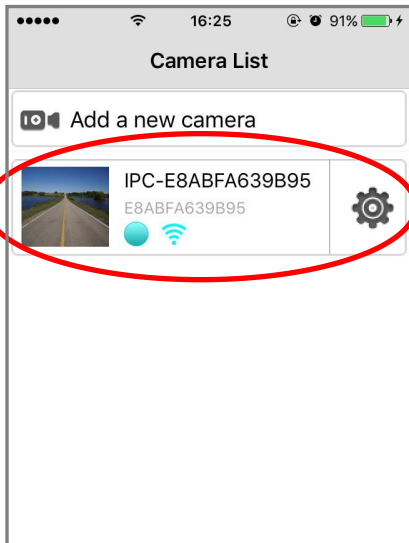

FIG-06



7) The camera which has a Bright Blue point icon shows that the camera has been connected to your smart phone.(FIG-06)

8) Tap on the camera which you want to see,(FIG-06), and you can start enjoying camera live video. (FIG-07)

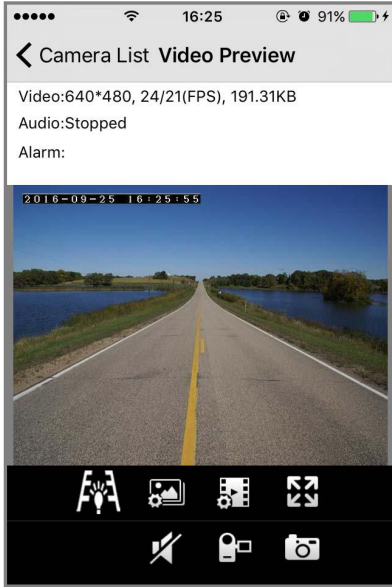

FIG-07

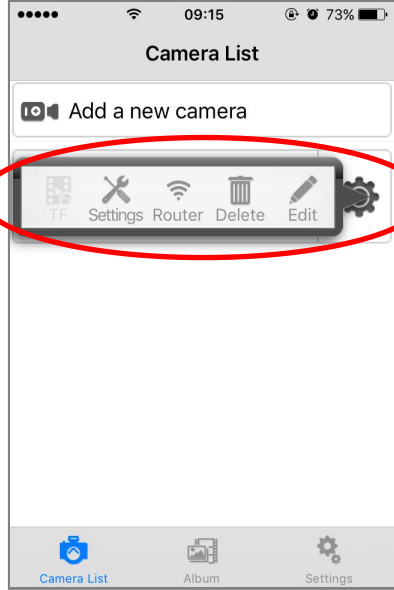

FIG-08

## 5. Mount Camera

1) Connect the antenna to the camera(FIG-09)

2) Mount the magnetic camera base on your tailgate, and then adjust it to a suitable angle (FIG-09)

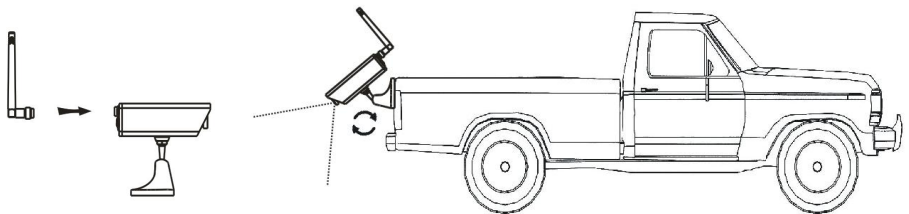
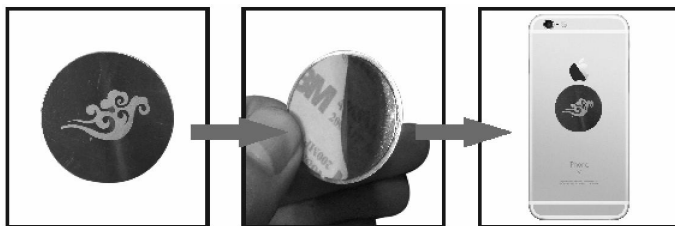

FIG-09

## 6. Mount Magnetic Holder for Smart Phone or Tablet (Optional)

1) Stick universal metal plate onto phone back.



Take out the metal plate

Remove paper cover from plate

Stick plate on the back of the your phone

2) Mount magnetic phone holder on dashboard

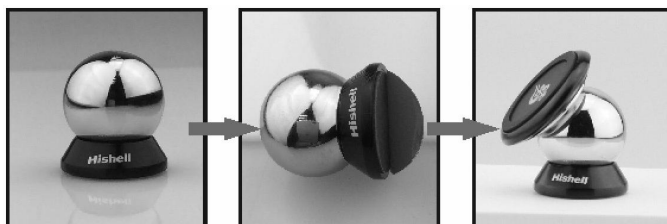

Take out the phone holder base

Remove paper from base

Stick base on dashboard and adjust position.

3) View Cellphone



# How to use tether for the camera (Optional)

1. Pulling the end of tether through the hole of another end and tie the tether on a fixed part of your vehicle.
2. Clip in the hook on the camera pole above the base.
3. Set the camera on the place you want to monitor.
4. Tether will add the extra security for the camera in case it drops off on the bumpy road.
5. Please tie tether at the place with proper height not to let the camera touch the ground when it drops.

## The fixed part of your vehicle

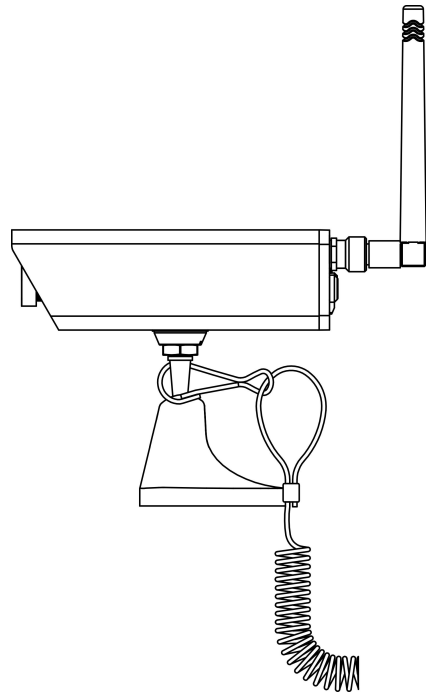
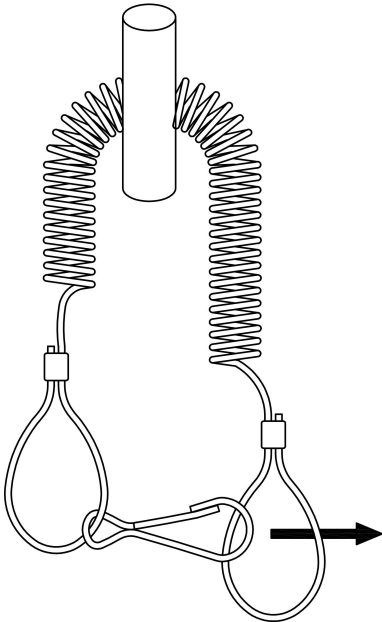

# MAIN FUNCTIONS OF CAMERA

1. Link your smart phone/tablet to camera's WiFi access point.
2. Support video and audio transmission.(Audio default is off)
3. Rechargeable battery can have run time up to 5 hours.
4. Send alert to phone/tablet when camera battery runs low.
5. Night vision range reaches 10 feet.
6. Water resistant feature.
7. Magnetic base for easy attachment.
8. Extendable antenna to bypass obstacle. (Extended antenna: ANT02 is not included)



9. Universal 1/4" mount hole to work with multiple accessories such as J-hooks, extension pole (EP01), and Gopro racket.

**Universal 1/4 "**  
**Mount Hole**

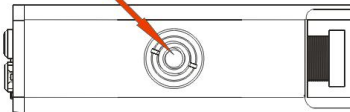

# MAIN FUNCTIONS OF APP

## 1. Switch between STA(Station) Mode and AP(Access Point) Mode

**STA mode:** Camera can connect to Internet via router.

**AP mode:** Camera allows smart phone to be linked directly.

**Camera factory default setting is AP mode.**

### 1) Switch from AP mode to STA mode

If you have a wireless router where the camera is installed, you can connect your camera to the WiFi network of this router, and then view the camera inside this router's network.

This can extend the wireless transmission distance of the camera, as long as your smart phone connects to this network, you can see the video from your camera. If your router is connected to the internet, you can view the camera on smart phone anywhere you have internet access.

① Open APP “Swift Wifi Cam” and come to the “camera list” page, Tap  icon of the camera which you want to set. You will see a setting menu pop up, Tap on “Router” on this pop up menu (FIG-10) . You will see a list of WiFi SSID nearby (FIG-11):

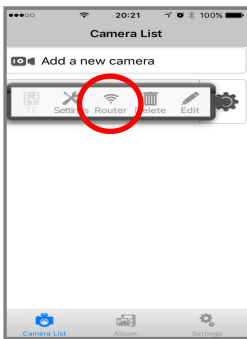

FIG-10

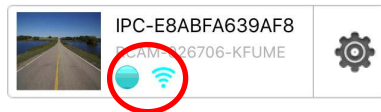

FIG-11



FIG-12

② Choose the WiFi SSID of your wireless router, input the correct password, Tap on “OK”, (FIG-12). Your camera will be rebooted and shift to STA mode. The WiFi icon in bright blue will be displayed once camera connect to router:



If wrong password is input, you camera will not be able to establish valid WiFi connection with router and have to wait another 30 seconds to go back AP mode and then you need setup camera again with correct password to function in STA mode.

2) Switch from STA mode to AP mode.

① Press reset button at the back and hold on it for 5 seconds.

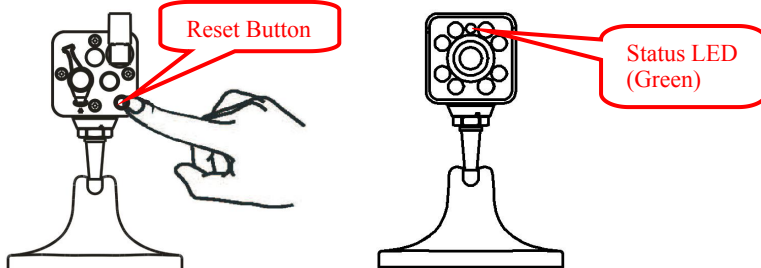

② After seeing that status LED become constant green color, please release reset button.

③ Wait about 20 seconds to finish booting process until seeing status LED blinking slowly every one second, your camera is ready on AP mode and its WiFi Access Point can be found by smart phone.

### Front Status LED Behavior

LED Behavior	Meaning
Green LED on	Camera power is on and is in normal booting process. After booting process is complete, previous saved AP mode or STA mode will be restored. The factory default setting is AP mode.
Green LED off	Camera is working in STA mode and has successfully connected to a previously linked router
Green LED fast blinking with every half second	Camera is in STA mode, but failed to connect to previously linked router. (It might be caused by router's password change, router's power off or too far away from router)
Green LED slow blinking with every second	Camera is working in AP mode and can be linked to smart phone / tablet DIRECTLY

## 2. Turn On/Off IR LED and Guide Line

Tap on icon  on the viewing camera page to turn on IR LED and guide line of camera .

1) Guide line can be used as assistance for vehicle backup.(FIG-14)

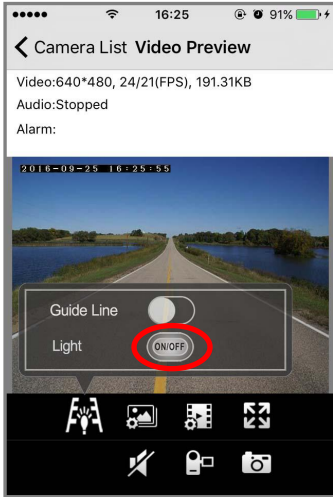

FIG-13

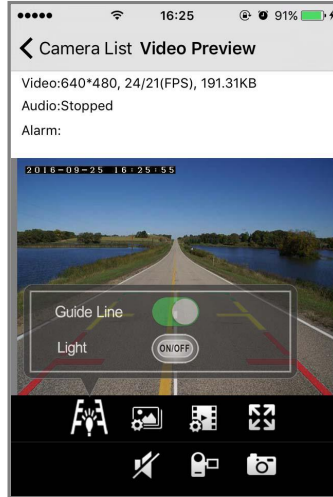

FIG-14

2) Camera IR light can be turned on/off via smart phone /tablet (FIG13)

## 3. Video Parameter Setting

Tap on  to set video parameter (FIG-15):

### 1) Mirror and flip function:

You can mirror camera image when you sit in the cab and put your camera facing to the back end of your car/truck/RV to get video as normal direction). Video can also be turned upside down by tapping on "Flip" button.

### 2) Image parameter setting:

You can adjust brightness, contrast, saturation, sharpness of camera for Comfortable viewing effect.





FIG-15

## 4. Video and Image Control

1) **Video quality setting:** You can change the video quality by choose your prefer quality level by tap icon  :

Video Quality	iOS APP	Android APP
Smooth	Not available	Keep the video steam faster and smoothly ( less delay)
Standard	VGA 640x480	VGA 640x480

2) **Take photo:** You can take a picture directly by taping on  and save it in local storage of smart phone.

3) **Record Video:** You can record videos directly by taping on  and save it in local storage of smart phone.

4) **Audio function:** You can open the camera voice by taping on 

5) **Zoom image:** You can zoom to full screen of the image by taping  and you can back to normal display by changing the smart photo orientation from horizontal to vertical. (Portrait orientation lock must be set to off in smart phone )

6) **Video record playback and photo review:**

You can playback the picture and video that you have taken and saved in local album of smart phone .

① Go back the camera list interface.

Refer to FIG-16

② Tap on  and select the camera

Album

which you want to see. Then you can find the video or image files(FIG-16)

Note: Android APP icon is 

③ Tap the files you want to see.

Then you can see the video or photo.

④ You can share these video/photo to your friends on Facebook/Twitter

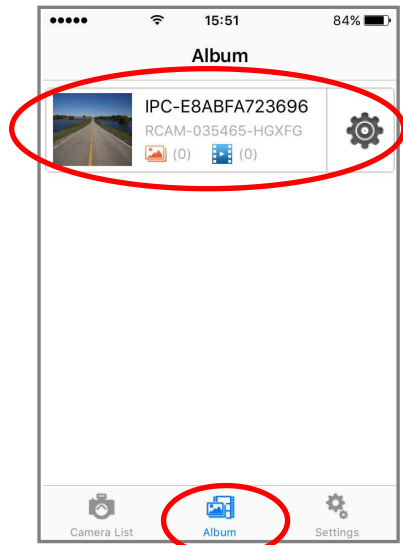

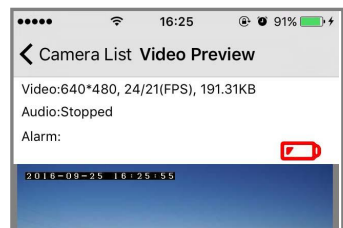

FIG-16

## 5. Camera Low Battery Alert

When camera battery runs low, you will see alert icon  displaying on the screen, 30 minutes left before camera shut down.





# ADVANCE FUNCTIONS OF APP

**1. Push Notice:** If the camera is connected to internet by router (STA mode), you can setup push notice function, and get a warning message when the alarm is triggered. Push notification function is setup as below:

1) Setup alarm trigger first: Enter the main menu of the camera list, tap  icon, then tap “Setting” icon (FIG-17), then enter camera setting menu (FIG-18).

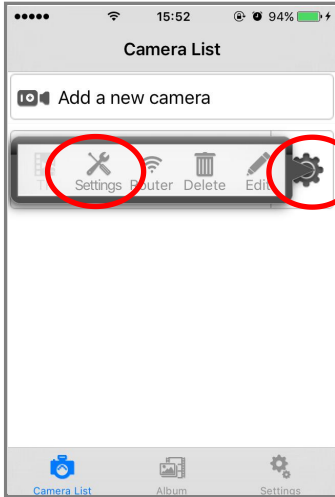

FIG-17

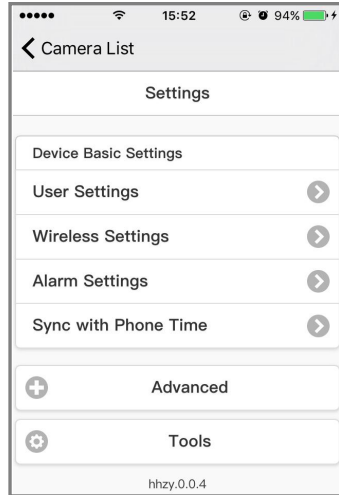

FIG-18

① Select and tap “Alarm setting” to enter into alarm setting menu. (FIG-19)

② Set “Enable Arm” button to “ON “ to enable alarm capability such as motion detection, camera missing etc..

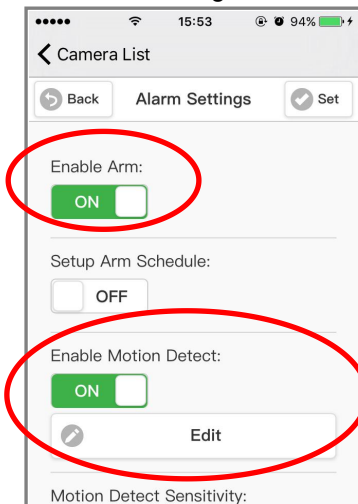

FIG-19

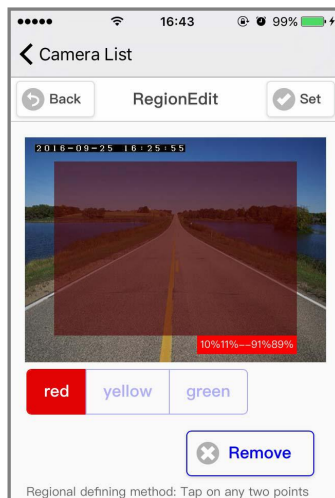
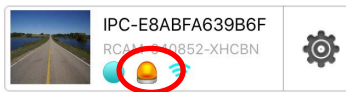

FIG-20

③ Set “ Enable Motion Detect” to “ON” and tap “Edit ”, you can set the motion detect area which you want. (FIG-20)



④ Tap on “Set” to complete alarm settings and back to the camera list. you can see the alarm icon 🚨 as following when alarm had been triggered.

⑤ Attention: “Setup Arm Schedule” function is NOT enabled for SH04.

2) Tap on the APP Settings icon and set the “Receive push notice” to ON(FIG-21).

3) Make sure the notification setting in your smart phone is set Swift WiFi Cam “Allow Notifications” to ON ( FIG-22)

4) You will get a push notification as warning message when the alarm is triggered (FIG-23), Tap “OK” , you can view the alarm picture on your phone.

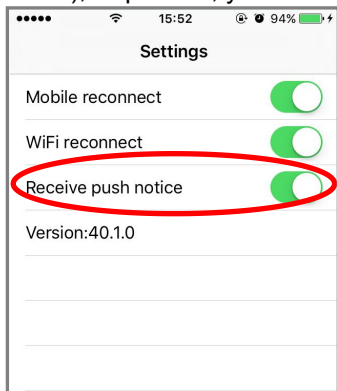

FIG-21



FIG-22

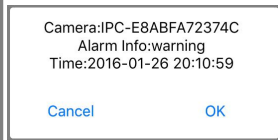

FIG-23

## 2. Mail Settings: Alert can also be sent out via email

1) Enable Open Alarm Mail in the setting.



2) Enter advance setting and then tap Mail Settings to setup mail details (FIG-25).

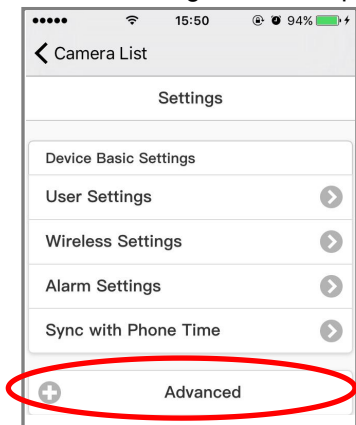

FIG-24

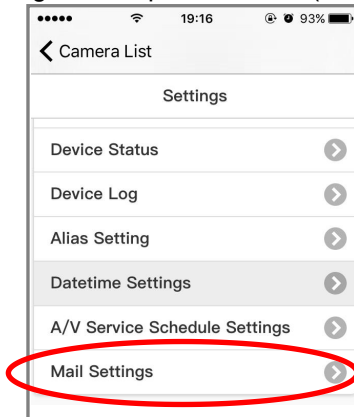

FIG-25

3) Fill in Sender and Receiver with corresponding email address, and then fill in sender's SMTP Sever, SMTP Use and SMTP Password, then tap on Set To finish the setting process. (FIG26,FIG27,FIG28 )

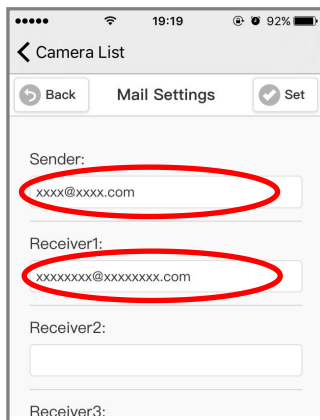

FIG-26

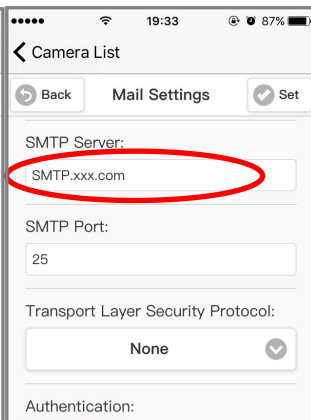

FIG-27

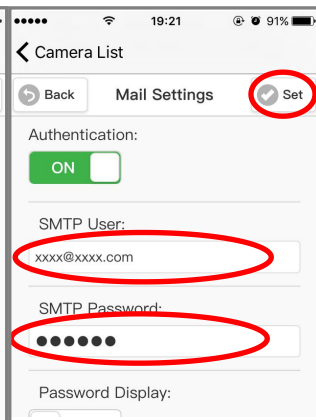



FIG-28

### 3. User name and authorization setting:

You can set the multiple user accounts for the camera, different user have different access right to control the camera. Alias of the camera could also be set here.

1) Enter the main menu of the camera list, Tap  icon, then Tap "Setting" icon (FIG-17), then enter camera setting menu.

2) Tap "User Settings", then you can set the user information(FIG-29).

3) Alias setting: Enter "Advanced" menu, select and Tap "Alias Setting", you can set camera alias.(FIG-30)

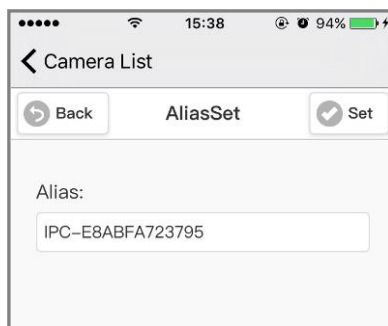
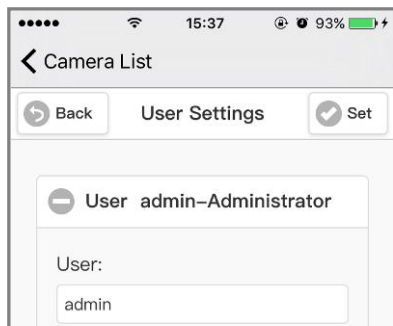

# SPECIFICATIONS

Item	Description	Specification/Parameter
<b>Wireless</b>	Working Mode	P2P/AP/STA
	Transmission standard/Protocol	IEEE 802.11B/G/N CSMA/CA ACK
	Modulation Mode	OFDM/DBPSK/DQPSK/CCK
	Transmission Distance	200 feet(open area site)
	Receiving Sensitivity	-85dBm@11M
	Transmission Power	17dBm (Max.)
	Antenna	2dBi
<b>Video</b>	Imaging Sensor	1/6.5"CMOS
	Total Pixels(Max)	648x488
	Resolution	640x480/320x240
	Compression Mode	MJPEG
	Frame Rate	25bps/QVGA; 15bps/VGA
	View Angle	60°
	Minimum Illumination	2.0Lux/F2.0 & 0Lux (IR ON)
<b>Power</b>	Power Supply Input	5VDC/12VDC
	Battery Type	Li- Battery 3.7V/1800MAH
	Consumption Current	240mA (IR off)
	Charge Time	Up to 5 hours (Power off)
	Working Time	5hours(IR OFF)/3 hours(IR ON)
<b>Night Vision</b>	LED Quantity	IRLED 6pcs
	IR LED Light Range	10 feet /60°
<b>Others</b>	Waterproof Level	IP65
	Magnet base	9kg (Vertical) attaching strength
	Weight	156g
	Outline Dimension	28 x 90 x 28 mm(W × H × T)
	Store temperature	-40°C~85°C / -40°F~185°F
	Operation temperature	-10°C~50°C / 14°F~122°F
	Operation humidity	0%~90%

1. Actual transmission range may vary according to weather, location and any obstruction.
2. All the specifications are subject to change without prior notice.

# TROUBLE SHOOTING

If you have experienced any operation problems, please try to follow the trouble shooting instruction below before contacting swift hitch technical support.

Troubled Condition	Solution
Can not find app in Google play or App store.	Check if you have spelled app name correctly as "swift wifi cam"
Smart phone or tablet can not find camera WiFi access point under AP mode	<ol style="list-style-type: none"> <li>1. Check if camera antenna is installed .</li> <li>2. Check if signals are blocked by any obstacles. (Normal distance is 200 feet without obstacles)</li> </ol>
Smart phone or tablet can not connect to camera under STA mode.	<ol style="list-style-type: none"> <li>1. Check if camera antenna is installed.</li> <li>2. Check if your smart phone or tablet is connected to network.</li> </ol>
Camera can not switch from AP mode to STA mode.	<ol style="list-style-type: none"> <li>1. Check if the camera is powered on.</li> <li>2. Check if camera antenna is installed.</li> <li>3. Check if your router is working properly and can be connected. If not, fix router problem.</li> <li>4. Check if you have selected the correct router SSID and input the right password in APP. If not, correct it.</li> </ol>
After power on, how do I know which mode the camera is in.	<ol style="list-style-type: none"> <li>1. If front status green LED blinks every 1 second, camera is in AP mode</li> <li>2. If front status green LED goes off, camera is in STA mode</li> <li>3. If front status green LED blinks every half second, camera is in STA mode but failed to connect to previously connected router</li> </ol>
The red charging LED in the rear of camera is not on when charging the battery.	1. Check if camera is powered on. If yes, build-in battery is not working. Please call swift hitch technical support.
Red charging LED does not go off after expected 5~6 hours.	1. Build-in battery can not hold charge any more. Please call swift hitch technical support.

Swift Hitch Tech Support:

Office Hours: Monday ~ Friday: 9:30am ~4:30pm (EST Time)

Tel: 617-600-8282

Email: [swifthitch@sun-tronics.com](mailto:swifthitch@sun-tronics.com)

Address: 200 Centreport Drive, Suite 365, Greensboro NC 27409 USA

## THANK YOU FOR BEING OUR CUSTOMER

# Certification Information

All our products meet the requirements of approval FCC and CE, and are granted the FCC/CE certification. They are authorized to bear FCC/CE mark.

## FCC/CE

This equipment has been tested and found to comply with the limits for a Class B digital device, pursuant to Part 15 of the FCC rules. These limits are designed to provide reasonable protection against harmful interference in a residential installation. This equipment generates, uses and can radiate radio communications. However, there is no guarantee that interference will not occur in a particular installation. If this equipment does cause harmful interference to radio or television reception, which can be determined by turning the equipment off and on, the user is encouraged to try to correct the interference by one or more of the following measures.

- Reorient or relocated the receiving antenna.
- Increase the separation between the equipment and the receiver.
- Consult the dealer or an experienced radio/TV technician for help.

This device complies with Part 15 of the FCC Rules. Operation is subject to the following two conditions.

- (1) This device may not cause harmful interference, and this device must accept any interference received, including interference that may cause undesired operation.
- (2) Changes and modification not expressly approved by the manufacturer or registrant of this equipment under Federal Communications Commissions rules.

This product is CE-certified which means that it fulfills all established rules and demands for usage within the EU. The CE-certification further implies that the radiation level is below the established radiation levels stated in the EMC directive 89/336/EEC and R&TTE directive (1999/5/EC)