

Trademark Acknowledgement

X-Star™, Starlink™ and Starpoint™ are trademarks of Autel Robotics Co., Ltd., registered in China, the United States and other countries. The Aute!® logo is a trademark of Autel Intelligent Technology Corp., Ltd. registered in the United States and other countries. All other marks are trademarks or registered trademarks of their respective holders.

Copyright Warning

No part of this manual may be reproduced, stored in a retrieval system or transmitted, in any form or by any means, such as electronic, mechanical, photocopying, recording, or otherwise, without the written permission of Autel Robotics.

Disclaimer

All information, specifications and illustrations in this manual are based on the latest information available at the time of printing. The content of this manual is subject to change. Autel Robotics reserves the right to make changes at any time without notice. Please download the latest version from <http://www.autelrobotics.com>. While information of this manual has been carefully checked for accuracy, no guarantee is given to the completeness and correctness of the contents, including but not limited to the product specifications, functions, and illustrations.

When using the X-Star/X-Star Premium, always refer to and follow the safety instructions in this manual. Autel Robotics takes no responsibility and accepts no warranty for direct or indirect product damage or injury if the user fails to follow the safety instructions. Autel Robotics will not be liable for any direct damages or for any legal, special, incidental, indirect damages or for any financial consequences (including the loss of profits).

The safety instructions herein covers situations which Autel Robotics is aware of. Autel Robotics cannot know, evaluate or advise you as to all of the possible hazards. You must be certain that any condition or service procedure encountered do not jeopardize your personal safety.

Safety Information

IMPORTANT

Before operating or maintaining this unit, please read this manual carefully, paying extra attention to the safety warnings and precautions.

For your own safety and the safety of others, and to prevent damaging the product and its features, it is important for you to read and understand the instructions and

all safety information presented throughout the product manual.

IMPORTANT

This product is not intended for use by children without adult supervision. Do not use incompatible components or alter the product in any way inconsistent with the instructions provided by Autel Robotics.

Take-off and Landing

- The aircraft should be placed in a distance of approximately 5 meters heading away from you on a leveled surface.
- Do not take off or land on slopes or uneven surfaces.
- Fly in an open and safe area; keep away from buildings, trees, people and moving vehicles
- Keep the aircraft steady still and approaching to the ground by one meter or less before landing.
- Land immediately when the low battery warning sign is displayed even if the flight is soon to be finished. The temperature and wind condition may affect the use of energy from the battery.

In Flight

- Avoid flying beside or above yourself or other people.
- Avoid flying the aircraft out of sight.
- Keep the aircraft away from potential obstacles such as trees, buildings etc.
- Leave enough space for turning and moving.
- Do not fly in severe weather conditions, including but not limited to typhoon, tornadoes, rain, storms, thunders, hail or snow.
- Avoid flying near hazardous situations, including but not limited to fire, explosions, landslides, floods or earthquakes.
- Keep away from facilities that could produce electromagnetic interference to avoid failure of location accuracy, including but not limited to power plants, power transmission lines, transformer substations or broadcasting towers.
- Avoid interferences from other remote controller transmitters or deliberate jamming attempts.
- Follow the instructions once you see a warning on the app.

 **WARNING**

If any part of the aircraft (including motor, battery, gimbal, compass, propellers, LED lights, binding buttons, etc.) or the remote controller fails to function properly or has visible/invisible damages, DO NOT FLY THE AIRCRAFT.

Battery Usage

The aircraft is powered by a Lithium-Polymer battery. LiPo/Li-Ion batteries can be extremely hazardous and special attention is required during usage.

Read and follow carefully all safety messages and instructions presented to avoid personal injury or property damage.

 **WARNING**

The Lithium-Polymer battery is factory replaceable only; incorrect replacement or tampering with the battery pack may cause an explosion.

Battery Use

- Use only the battery and battery charger provided by Autel Robotics. An unqualified battery or charger may present a risk of fire, explosion, leakage, or other hazards. Autel Robotics takes no responsibility for any damage caused by non-Autel-Robotics batteries or charging devices.
- Always turn off the aircraft before installing or removing the battery.
- Remove the battery before assembly or when not in use.
- Keep the battery away from water or any kind of liquid. If the battery gets in touch with liquid, it may lead to an explosion while used or charged.
- Do not expose the battery to fire, explosions, or other hazards.
- Do not disassemble, open, crush, bend, deform, puncture, or shred the battery.
- Do not modify, remanufacture, or attempt to insert foreign objects into the battery.
- Do not place heavy objects on the battery or charger.
- Stop using or charging the battery immediately whenever the battery starts to swell, smoke or leak.
- Use the battery in temperatures between -10°C and 45°C . Extremely high temperatures may cause a fire or explosion, extremely low temperatures may lead to permanent battery damage. Before using a low-temperature battery (between -10°C and 15°C) for flight, you need to fully charge it in required temperatures, or insert it into an aircraft and make the aircraft hover at the altitude of 1m to warm the battery up to 15°C or higher. The battery temperature can be checked in the app.

- Do not use the battery in strong electrostatic or electromagnetic environments. Electrostatic or electromagnetic interference may lead to serious accidents during flight.
- The heavier the payload, the shorter the flight time, as more battery power may be consumed.
- Remove the battery from the aircraft immediately if the aircraft falls into water during flight. Leave the battery in an open area and keep a safe distance away until it is completely dry. Stop using the battery and contact Autel Robotics customer support for a replacement.

Battery Charging

- Do not use a damaged battery charger.
- Disconnect the charger when not in use and examine the charger's condition regularly.
- Do not leave the battery unattended during the charging process.
- Do not charge the battery immediately after using it, as overheat protection will be activated to prevent the battery from being charged before it cools down completely.
- The charging time varies depending on the remaining battery level.
- Since over charging may shorten the battery life, stop charging the battery after it is fully charged.
- Make sure to go through a charge cycle (charging the battery to 100% and then discharging it to 7% or lower) every three months, or once the battery is cycle-charged for 20 times.

Battery Storage

- Keep the battery out of reach of children and pets.
- Do not leave the battery close to moisture or heat sources. Store the battery in a dry and ventilated area at room temperature (ideally 22°C to 28°C).
- Do not place the battery beside hard or sharp items, or on a conductive surface (e.g., metal plate).
- Do not place the battery in wet grass or in the pocket with metal objects.
- Disconnect and remove the Li-Po battery from the aircraft after use to prevent trickle discharge. During storage, make sure the battery level does not fall below 3V.
- Using or storing the battery in extreme environments may reduce battery life.
- Battery life inevitably shortens over time. And battery life may be reduced if the battery is left unused over extended periods of time.
- Completely discharge the battery before disposal.
- Dispose of the battery properly at specified battery recycling locations.
- Battery electrolytes are highly corrosive. If any electrolytes make contact

with your skin or eyes, immediately wash the affected area with fresh running water and see a doctor.

Reminders

- Flying with an experienced pilot for the first flight is strongly recommended.
- Keep small or electrical parts out of the reach of children.
- Keep away from heat sources or humid and hostile environments.
- Check the weather before flying, including air temperature and wind speed.
- Make a thorough preflight check before each flight ( 26)
- Use only authorized accessories approved or provided by Autel Robotics.
- Do not attempt to disassemble, modify or reconstruct any part of the devices. Autel Robotics will not be responsible for damages resulting from any artificial reason.
- Do not use this product for illegal purposes.

Services and Support

 www.autelrobotics.com

 (844)-898-0290 (U.S.A.)

 support@autelrobotics.com

Or contact your local retail agent for technical assistance.

Contents

■ BEFORE STARTING	1
USING THIS MANUAL	1
BEFORE YOUR FIRST FLIGHT	1
■ GETTING TO KNOW THE SMART DRONE	2
AIRCRAFT	2
REMOTE CONTROLLER	10
■ PREPARING THE FLIGHT	18
PREPARING THE BATTERY	18
REMOVING THE GIMBAL HOLDER	20
PREPARING THE REMOTE CONTROLLER	21
CONNECTING YOUR MOBILE DEVICE	22
CALIBRATING THE COMPASS	23
INSTALLING THE PROPELLERS	24
■ FLIGHT OPERATIONS	26
PREFLIGHT CHECKLIST	26
REMOTE CONTROLLER AND FLIGHT OPERATIONS	27
USING THE STARLINK™ APP	35
■ MAINTENANCE AND SERVICE	56
FIRMWARE UPGRADE	56
TROUBLESHOOTING TIPS	57
STORAGE AND MAINTENANCE INSTRUCTIONS	58
CUSTOMER SERVICE	58
■ WARRANTY	60
■ APPENDIX	61
REGULATORY COMPLIANCE AND FLIGHT RESTRICTED AREA	61
TECHNICAL SPECIFICATIONS	63





1

Before Starting

Using This Manual

Thank you for purchasing Autel Robotics' product **X-Star/X-Star Premium**. Please read the manual carefully before you use the smart drone and retain the manual for future reference. Should your smart drone fail to operate correctly, refer to **Troubleshooting Tips** (📄 57).

Legend

-  **WARNING:** Precautions of a potentially hazardous situation which if not avoided could result in personal injury or property damage.
-  **IMPORTANT:** Important information that demands special attention related to the smart drone's operation.
-  **NOTE:** Additional information that complement the current topic.
-  **TIPS:** Information that helps to improve the usability of the smart drone.
-  **REFERENCE:** A page number that guides you to the section containing relevant information in this manual.

Before Your First Flight

Before using the X-Star/X-Star Premium, download and install the **Starlink™** app on the App Store or Google Play by searching for 'Autel Starlink'. The app enables a live stream and full functions of flight and camera control on your mobile device.



Read the following documents before using the X-Star/X-Star Premium:

X-Star & X-Star Premium Packing List

X-Star & X-Star Premium Quick Guide

X-Star & X-Star Premium User Manual

2

Getting to Know the Smart Drone

The **X-Star** series is a new generation of smart unmanned aerial vehicle, featuring easy operation and high stability. With the advanced built-in Smart Flight System, a high-performance remote controller, and a powerful mobile app, the **X-Star** allows safe and stable flight maneuvers which can be operated both manually and automatically. The stabilized 3-axis camera gimbal offers ideal solutions for smooth aerial photography and video recording, making the system incredibly versatile and powerful.

The X-Star series comes in two models: the **X-Star** and **X-Star Premium**, which are both equipped with an integrated 4k camera gimbal. The **X-Star** adopts a self-generated WiFi network, while the **X-Star Premium** utilizes HD video streaming to establish a live video link with the mobile app **Starlink™** as you fly.

This manual elaborates in detail on the functions and operations of the **X-Star** and the **X-Star Premium**.

Aircraft

The **X-Star/X-Star Premium** aircraft is a quadcopter with an integrated stabilized camera gimbal. An HD camera is also integrated.

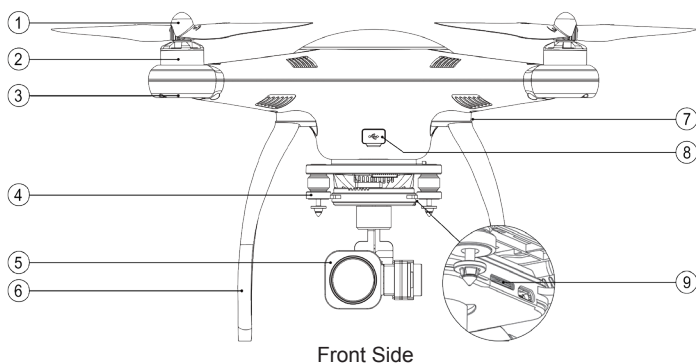

Functionality Description

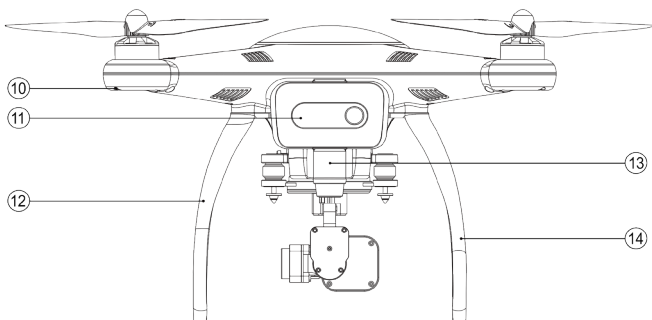

- ① Propeller
- ② Motor
- ③ Front LED Indicator Light ( 5)
- ④ 3-axis Gimbal ( 8)
- ⑤ Camera
- ⑥ Front Sticker
- ⑦ RC Binding Button
- ⑧ Micro-USB Port
- ⑨ Micro-SD Card Slot



Rear Side

- ⑩ Rear LED Indicator Light ( 5)
- ⑪ Aircraft Battery ( 6)
- ⑫ Landing Gear
- ⑬ Starpoint™ Positioning Module
- ⑭ Compass Module

Built-in Smart Flight System

The **X-Star/X-Star Premium** features a built-in smart flight system which provides stable and user-friendly flight control. The system consists of various sensors such as the Global Navigation Satellite System (GNSS) receiver, the Compass, the Inertial Measurement Unit (IMU) and barometer. It works as the central computer of the aircraft and supports various functions, such as Intelligent Orientation Control (IOC), Go Home, Failsafe, Starpoint™ Positioning System, etc.

Smart Flight System Modules

Module	Description
IMU	An electronic device consisting of a 3-axis gyroscope and a 3-axis accelerometer that measure the acceleration and angular rates of the aircraft. An automatic IMU calibration is performed every time you start the aircraft.
Compass	Measures geomagnetic field and provides heading reference for the aircraft.
GNSS Receiver	Receives GNSS (GPS/GLONASS) signals to determine the latitude, longitude and altitude of the aircraft.

Barometer	Measures atmospheric pressure to determine the pressure altitude of the aircraft.
Ultrasonic Sensors	Measures the distance between the aircraft and the ground.
Monochrome Camera	Tracks the x- and y-axis location of the moving aircraft relative to the ground.



Smart Flight System Functions	
Function	Description
IOC	Configures the aircraft to fly in the direction relative to the home point. (📄 30)
Go Home	Commands the aircraft to return and land at the specified home point. (📄 30)
Failsafe	Enables the aircraft to take automatic protection measure in the event of lost communication between the aircraft and remote controller, or low battery situation. (📄 31)
Starpoint™ Positioning System	Enables the aircraft to hover precisely in areas where GPS signal is not available. (📄 32)

 **NOTE**

A home point is usually memorized by the system each time as the point where the aircraft takes off. The home point can be repositioned via the app. (📄 38) The altitude of the original home point remains unchanged.

Supported Flight Modes	
Flight Modes	Description
GPS Mode	Stabilizes and holds the aircraft in position and altitude on stick release (requires at least 6 GNSS satellite signals), providing stable and smooth flight maneuvers, as well as safety features including Go Home, IOC and Failsafe.
ATTI Mode	Stabilizes and holds the aircraft in altitude on stick release. The ATTI mode provides more agility in flight control by commanding the attitude (roll and pitch angles) of the aircraft directly.

NOTE

It is highly recommended to operate outdoor flights in GPS mode for maximum safety. ATTI mode is disabled by default, and GPS mode is always enabled when good GPS reception is available. ATTI mode can be enabled through the mobile app: **Settings** () > **Flight Control Settings** () > **Advanced Settings** > **Enable ATTI Mode**.

Flight LED Indicator

The LED indicators on the aircraft can be found on both the front and rear arms. The front indicators help you identify the position of the aircraft's nose, and the rear indicators show the current flight status of the aircraft.

The LED indicators will light up when you turn on the aircraft. The table below describes the meanings of the LED indicator's statuses.

- | | | | |
|---|--------------------------------|---|--------------------------------|
|  | Indicates solid light | R | Indicates red colored light |
|  | Indicates slow flashing light | G | Indicates green colored light |
|  | Indicates quick flashing light | Y | Indicates yellow colored light |

Example: "R-●" stands for RED SOLID light.

Definitions of Flight LED Indicator Light Status	
R-● (Front LEDs)	Indicates the direction of the aircraft's nose after the aircraft is powered on.
R&G-○○ (Rear LEDs)	Indicates a warm-up procedure is activated when the aircraft is powered on and more than 6 GPS satellites are available.
R&Y-○○ (Rear LEDs)	Indicates a warm-up procedure is activated when the aircraft is powered on and less than 6 GPS satellites are available.
G-○ (Rear LEDs)	Indicates the aircraft is in GPS mode, or the Starpoint™ Positioning System is working. GPS mode can be activated only when more than 6 GPS satellites are found.
Y-○ (Rear LEDs)	Indicates the aircraft is in non-GPS mode (or less than 6 GPS satellites are found), and the Starpoint™ Positioning System is not working.
Y-○○ (Rear LEDs)	Indicates the communication between the aircraft and remote controller is lost.
Y-● (Rear LEDs)	Indicates abnormal magnetic field. Make sure that the aircraft is free from all magnetic interferences.

R-⊙ (Rear LEDs)	Indicates Low Battery Warning (meaning the battery level is less than 25%).
R-○○ (Rear LEDs)	Indicates Critical Low Battery Warning (meaning the battery level is less than 15%), or the battery cannot be identified.
R-⊙ (Front & Rear LEDs) Accompanied by a beep	Indicates hardware problems possibly caused by IMU deviation or other abnormalities.

 **NOTE**

The rear LEDs will flash green light twice when a new parameter or waypoint setting has been acknowledged.

Aircraft Battery

The aircraft battery is a rechargeable Li-Po battery with the capacity of 4900mAh specially designed for the X-Star/X-Star Premium aircraft. It can only be charged with the charger supplied in the X-Star/X-Star Premium package, and can provide up to 25 minutes of continuous flight if fully charged.

● Smart Features

The aircraft battery features several smart functionalities for charge-discharge management that preserves battery life.

Aircraft Battery Features	
Balancing	Balances the voltage of each battery cell to prevent overcharging or over-discharging.
Communication	Retrieves and transfers battery info, including battery level, current, voltage, battery life, and temperature to the aircraft and the remote controller.
Charging Temperature Detection	Stops charging when temperature is out of the suitable range.
LED Capacity Indicator	Indicates current battery level.
Overcharging & Over-discharging Protection	<ul style="list-style-type: none"> • Stops charging when battery voltage reaches 17V. • Stops discharging when battery voltage reaches 10.8V.

Short Circuit Protection	<ul style="list-style-type: none"> Cuts off power supply when a short circuit occurs. All LED lights on the battery front panel will flash green when a short circuit is detected.
Power Saving	Turns off the battery automatically after 10 minutes of inactivity.

● **Basic Functions**

The front panel of the aircraft battery contains 4 LED capacity indicators and 1 **Power** button.

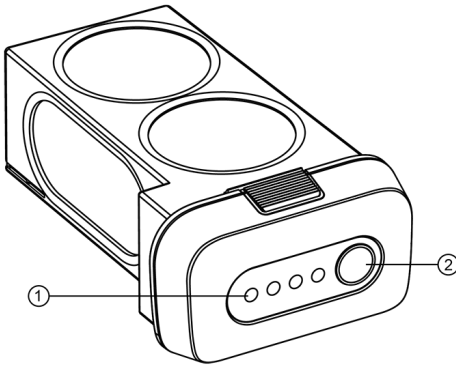

Aircraft Battery

- ① Capacity Level Indicator Lights
- ② Power Button – allows you to check the battery level and turn on/off the battery









➤ **To turn on/off the battery**

Press and hold the  button for 3 seconds.

➤ **To check the battery level when the battery is powered off**

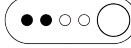
Press the  button.

The table below describes the corresponding battery levels indicated by the capacity indicator lights once you press the  button.

Battery Level Indicator Status While Discharging				
91%~100%	76%~90%	66%~75%	51%~65%	41%~50%
				
26%~40%	16%~25%	1%~15%	0%	
				
<p>● - Indicates solid green light; ◎ - Indicates flashing green light; ○ - Indicates no light</p>				

The Xteady R12 Gimbal

The Xteady R12 camera gimbal is a quick-mount stabilized gimbal with three axes. It is specially designed to minimize camera vibration and deliver smooth aerial photography.

It is powered through the aircraft battery, and therefore turned on at the same time with the aircraft. A self-test is performed each time when the gimbal starts up.

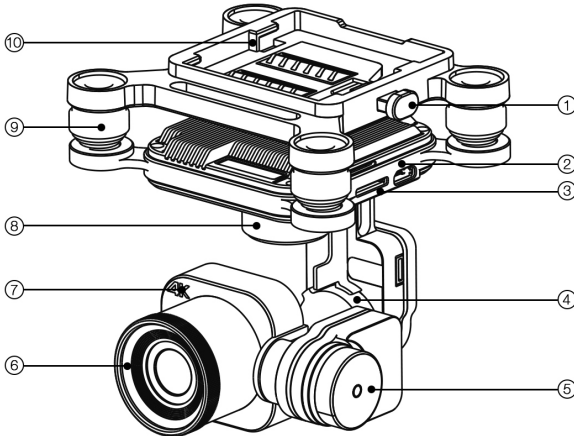

- | | |
|----------------------|----------------------|
| ① Unlock Button | ⑥ Filter |
| ② Micro-USB Port | ⑦ Camera |
| ③ Micro-SD Card Slot | ⑧ Yaw Motor |
| ④ Roll Motor | ⑨ Vibration Absorber |
| ⑤ Pitch Motor | ⑩ Gimbal Connector |

NOTE

- A Micro-SD card is provided inside the Micro-SD card slot with different storage capacity according to your aircraft model.
- The Xteady R12 Camera Gimbal is attached with a gimbal holder which protects the gimbal from incidental rotation to avoid damage. Remove the holder before powering up the aircraft ( 20).

WARNING

Do NOT install or remove the gimbal after the aircraft is powered up, as this may cause a short circuit of the video link module.

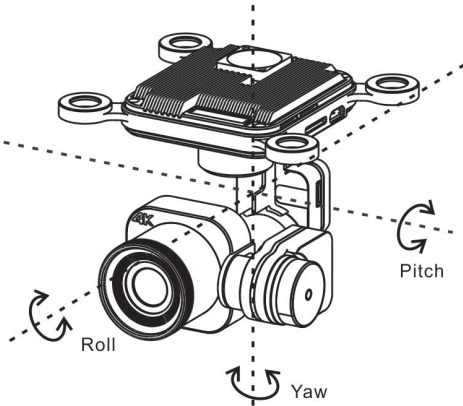

The Xteady R12 gimbal for **X-Star/X-Star Premium** has three axes (pitch, roll, yaw) and supports two working modes (Stabilized mode, FPV mode):



Stabilized Mode – The gimbal's yaw movement is synchronized with the aircraft while its pitch and roll movements remain independent of the aircraft for maximum stabilized aerial photography.

FPV Mode – The gimbal's roll and yaw movements are synchronized with the aircraft while its pitch movement remains independent of the aircraft for an immersive piloting experience from a first person view.

➤ **To remove the gimbal**

1. Hold the gimbal and press the **Unlock** button () at the side.
2. Slide the gimbal towards the **Unlock** direction indicated by the () icon beside the **Unlock** button.

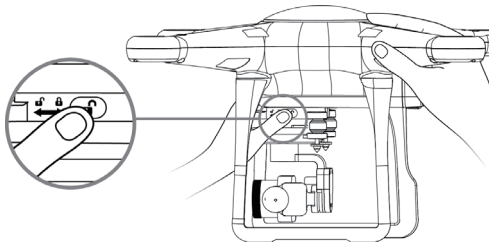

➤ **To install the gimbal**

1. Match the gimbal connector to the quick-mount interface at the bottom of the aircraft.

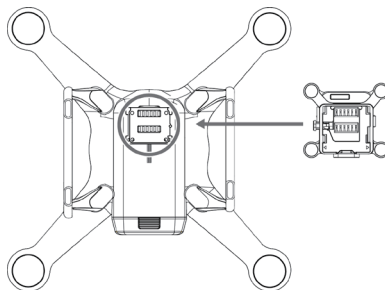

- Slide the gimbal connector onto the quick-mount interface towards the **Lock** direction indicated by the () icon beside the **Unlock** button. You will hear a clicking sound when the gimbal is properly mounted.

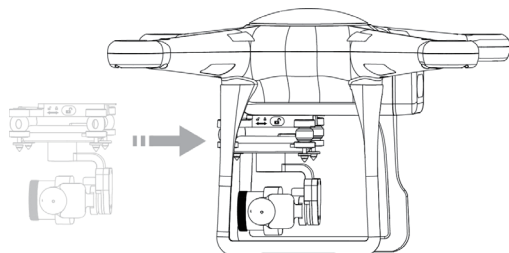

Camera

The **X-Star** and **X-Star Premium** are both equipped with a 4K UHD camera. The camera supports various shooting modes including single shot, burst, AEB and timelapse. Videos can be recorded in MOV or MP4 formats, and photos can be saved in DNG or RAW formats. An HD live view from the camera can be displayed on your mobile device through the mobile app **Starlink™**.

Remote Controller

The remote controller enables wireless communication with the aircraft through a 5.8 GHz radio frequency band. The maximum working range of the remote controller in an open area is about 500m when set as CE standard, or about 1000m (**X-Star**)/2000m (**X-Star Premium**) when set as FCC standard.

The built-in 2.4GHz WiFi module of the **X-Star** remote controller and 900MHz HD video streaming module of the **X-Star Premium** remote controller allow video downlink from the aircraft for real-time flight and video data displayed on the app, enabling convenient control of aerial photography and remote piloting.

IMPORTANT

The X-Star network is only established when the aircraft, the remote controller and the mobile device are properly connected through the WiFi network (**X-Star**) or HD video streaming (**X-Star Premium**).

Functionality Description

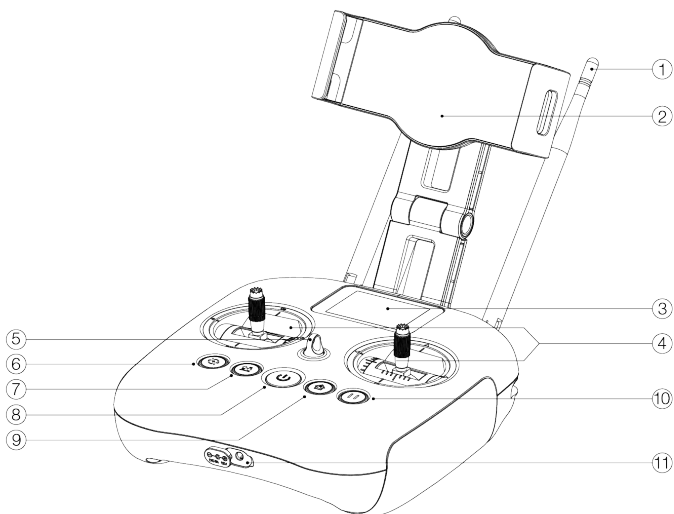

① Antennas

- The left antenna transmits 5.8 GHz RF signal to the aircraft for sending commands and receiving flight information.
- Both antennas receive 2.4 GHz WiFi signal (**X-Star**) or 900 MHz HD video signals (**X-Star Premium**) from the aircraft and transfer the flight data and camera data to the connected mobile app.

② Mobile Device Holder

- Holds your mobile device with a 180° adjustable viewing angle for optimum visibility.
- The clamp on the holder can be stretched and also rotated so that you can place your mobile device of varying sizes in different orientations.

③ Flight Information Panel

Displays the flight status, warning messages and real-time instructions. ( 12)

④ Command Sticks

- Control the orientation and movement of the aircraft.
- Each command stick is covered with a screw cap that can be used with either end facing upward. These two ends are designed with different textures to meet different needs. The gear-shaped end enhances your grip stability, while the flat end maximizes your hand-touch comfortability. To switch between both ends, simply unscrew the cap and screw it up upside down.

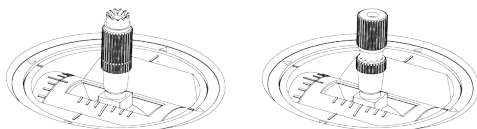

⑤ Strap Hole	Attached to a neck strap for easy portability.
⑥ Motor Starter	Starts the motors.
⑦ Take-off/Landing Button	Commands the aircraft to take off or land.
⑧ Power Button	Press and hold for 2 seconds to turn on/off the remote controller. You will hear a buzz sound. The power button shows a solid green light when you turn on the remote controller.
⑨ Go Home Button	Commands the aircraft to return to the home point.
⑩ Pause Button	Commands the aircraft to stop moving and hover in position when necessary.
⑪ Power Port	Connected to the X-Star/X-Star Premium charger to charge the built-in battery of the remote controller.

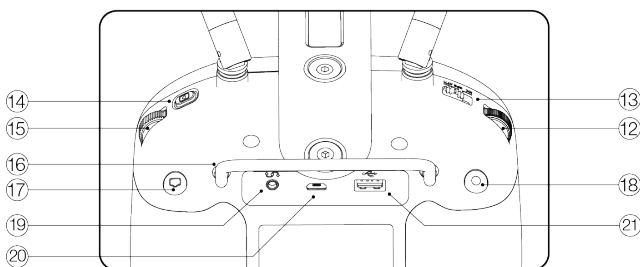

⑫ Gimbal Pitch Dial	Turn the dial to control the tilt angle of the gimbal.
⑬ Flight Mode Switch	Switch between IOC, GPS and ATTI modes.
⑭ Playback Button	Plays back the captured images or videos. (Only functions when the remote controller is connected to the mobile app.)
⑮ Camera Settings Dial	Turn the dial to adjust the Advanced Camera Settings . ( 39)
⑯ Support Stand	Holds up the remote controller at a 40 degree angle.
⑰ Shutter Button	Takes a photo. If burst mode is selected, the set number of photos will be taken with one press.
⑱ Record Button	Records a video. Press again to stop recording.

⑲ CAN-Bus Port	Connects two remote controllers with one operator as the instructor and the other as the learner. (📖 52)
⑳ Micro-USB Port	Reserved port.
㉑ USB Port	Connects to a mobile device through a USB cable.

Flight Information Panel

The LCD **Flight Information Panel** found on the **X-Star/X-Star Premium** remote controller is designed to provide you with intuitive information during the flight, including the flight status, warning messages, real-time instructions, etc. This section introduces the function of this panel.

● Remote Controller Calibration

Every time you see **Calibrate RC** on the **Flight Information Panel**, please calibrate the two command sticks and the Gimbal Pitch Dial. You can calibrate your remote controller according to the following steps, or using the mobile app instead (📖 51).

➤ To calibrate the remote controller

1. Turn off the remote controller, and then press and hold the (🔌) and (🔊) buttons simultaneously until the RC calibration screen appears as shown on the right. The two crossed bars represent the left and right command sticks, and the horizontal bar at the bottom stands for the Gimbal Pitch Dial.
2. Release both command sticks and the Gimbal Pitch Dial naturally to the central position. The three central rounds on the RC calibration screen will be highlighted successively.
3. Push both command sticks to the ends of their 4 directions, and turn the Gimbal Pitch Dial clockwise and counterclockwise to its 2 ends, holding respectively until you hear a beep. All the bars on the screen will be fully highlighted when your calibration is completed.

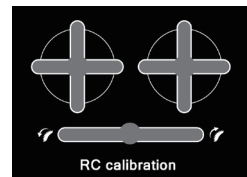
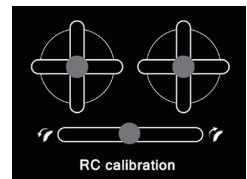
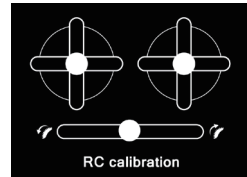

● Binding

The remote controller and the aircraft are bound by default when both devices are powered up. However, when you change an aircraft or remote controller, or activate the **RC Binding Button** on the aircraft, you need to rebind your aircraft and remote controller.

➤ To bind the aircraft and remote controller

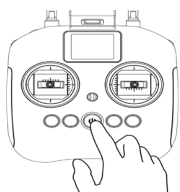

1. Turn off the remote controller.

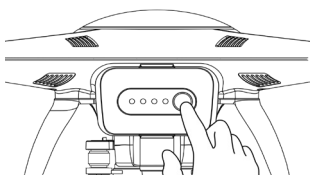

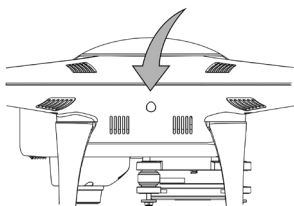

2. Turn on the aircraft.



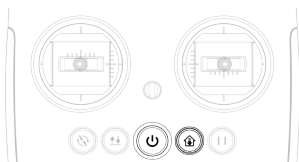

3. Press and hold the **RC Binding Button** on the aircraft for about 3 seconds, and the binding indicator beside the **RC Binding Button** will flash slowly in green light indicating the aircraft is ready to rebind.



4. Press and hold the () and () buttons on the remote controller, and the binding indicator will turn to solid green light once your binding is successful.



NOTE

You may also use the app to bind the aircraft and remote controller via **Settings** () > **RC Settings** () > **RC Binding**. ( 52)



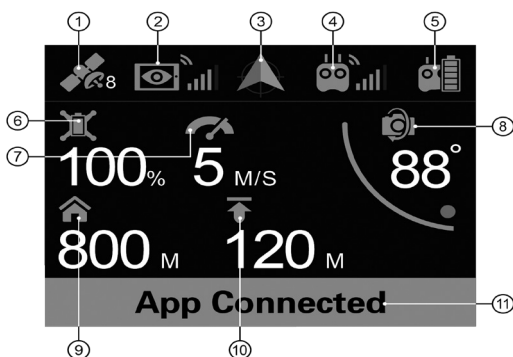

● Main Interface

When the video link has been connected properly, the main interface will appear as follows:



① GPS Signal	Indicates the signal strength of GNSS satellites.
② Video Link Signal	Indicates the WiFi video signal (X-Star) or HD video signal (X-Star Premium) strength.
③ Flight Orientation	Indicates the yaw angle relative to the north.
④ Remote Controller Signal	Indicates the control signal strength of the remote controller.
⑤ Remote Controller Battery	Indicates the battery level of the remote controller.
⑥ Aircraft Battery	Indicates the battery level of the aircraft.
⑦ Flight Speed	Indicates the flight speed of the aircraft.
⑧ Tilt Angle	Indicates the tilt angle of the camera.
⑨ Flight Distance	Indicates the horizontal distance between the aircraft and the home point.
⑩ Flight Altitude	Indicates the altitude of the aircraft relative to the home point.
⑪ Flight Status Bar	Displays the real-time flight status, the function of the button you have activated, and warning messages.

Indicator Lights

On the remote controller, there are 5 indicator lights in total. They are found on the Motor Starter , the Take-off/Landing Button , the Power Button , the Go Home Button , and the Pause Button . Each of them shows a different status in a different situation.

The following table describes the definitions of the indicator light status.

- | | | | |
|---|--------------------------|---|--------------------------------|
| ● | Indicates solid light | R | Indicates red colored light |
| ◎ | Indicates flashing light | G | Indicates green colored light |
| ○ | Indicates no light | Y | Indicates yellow colored light |

Example: “R-●” stands for SOLID RED light.



G-●:	A. Sufficient battery when RC is in use B. Fully charged in charging state with power on
G-◎:	In charging state with power on
Y-●:	Low battery warning
R-●:	In charging state with power off
R-◎:	In process of RC firmware upgrade
○:	A. Fully charged in charging state with power off B. Power off while not in charging state

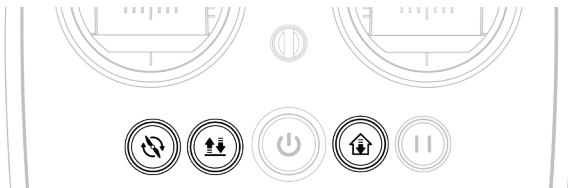

G-●:	Activate each button by holding for 2s until you hear a beep sound
○:	1s after you release each button
G-◎: (Go Home Button)	The aircraft is performing the Go Home procedure



G-●: Simply press the button shortly to activate the **Pause** function

○: 1s after you release each button

Remote Controller Buzzer Alerts

The built-in buzzer of the remote controller makes different alert sounds according to various status alarms, such as low battery warning, video link error or lost aircraft communication. The different alerts are described below.

Remote Controller Buzzer Alerts	
Aircraft Low Battery Warning (about 25%)	1 quick beep every second (lasts for 5s), with 2 RC vibrations
Aircraft Critical Low Battery Warning (about 15%)	5 quick beeps every second (last for 5s), with 5 RC vibrations
RC Low Battery Warning (10%)	1 quick beep every second (lasts for 5s)
RC Critical Low Battery Warning (5%)	5 quick beeps every second (last for 3s), with 2 RC vibrations
Aircraft & RC Communication Lost	2 quick beeps every second (last for 5s), with 1 RC vibration
Video Link Disconnected	3 quick beeps in 1 second
Compass Interference	3 beeps with 3 RC vibrations
Standby Notification Tone	3 beeps every 15 minutes of inactivity

3

Preparing the Flight

The **X-Star/X-Star Premium** features a user-friendly design that requires very simple assembly to get the aircraft ready to fly. However, it is essential to read and follow all the instructions and warnings in this manual prior to assembly, setup or use, in order to operate safely.



WARNING

Do not use incompatible components or alter this product in any way inconsistent with this manual. Failure to operate this product in a safe and responsible manner could result in injury or damage.

Preparing the Battery

Installing and Removing the Aircraft Battery

➤ To install the battery

1. Make sure the battery is powered off before installation.
2. Insert the battery into the aircraft battery compartment as shown on the right. The battery will firmly click in when it is properly installed.

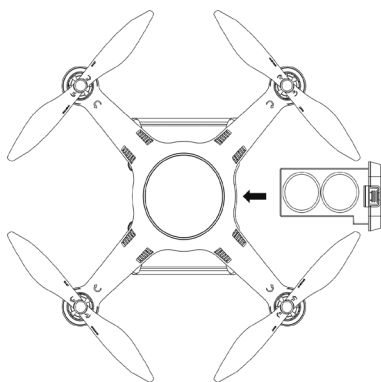

➤ To remove the battery

1. Make sure the battery is powered off before removal.
2. Press and hold the top and bottom tabs on the battery, and pull it out slowly.

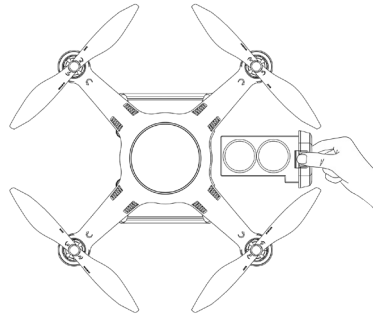

Charging

The aircraft battery and the remote controller can be charged simultaneously with the charger supplied in the **X-Star/X-Star Premium** package. There are two connectors attached to the adaptor block on the charger. The wide square connector with a cooling fan goes with the aircraft battery. The fan will automatically turn on and off as needed during the charging cycle. The tiny circular connector is used to charge the remote controller.

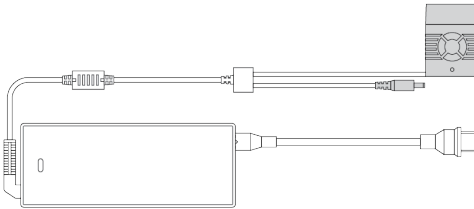

➤ To charge the aircraft and remote controller

1. Open the cap on the wide square connector and match the interface inside to that of the aircraft battery.

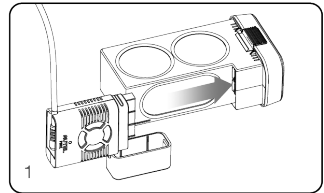

! IMPORTANT

- The aircraft battery should be fully charged before use for the first time.
 - To save battery life, please turn off the battery before charging.
-

- Flip over the protector on the Power Port of the remote controller, and plug the small circular connector into the Port.

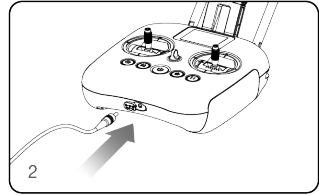

- Plug the charger into a power outlet.
 - The battery level indicator lights on the aircraft battery will illuminate and indicate the current battery level during charging, and will turn off when the battery is fully charged.

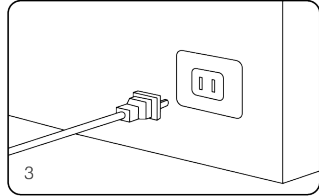

Battery Level Indicator Status While Charging				
>95%	>80%	>50%	>25%	>0%
●●●●○	●●●●◎	●●●●○	●◎◎◎○	◎◎◎◎○
● - Indicates solid green light; ◎ – Indicates flashing green light				

- The  button on the remote controller will illuminate solid green light (when RC power on) or solid red light (when RC power off) during charging. When charging is completed, it is prompted on the **Flight Information Panel**, and you will hear two beep sounds.
- When charging is completed, disconnect the charger and the aircraft battery/remote controller.

 **NOTE**

For a full charge, the aircraft battery requires 1 hour and the remote controller requires 4.5 hours approximately.

○ Removing the Gimbal Holder

Remove the gimbal holder before powering up the aircraft to avoid damage. Pull out the attached gimbal holder carefully as illustrated below.

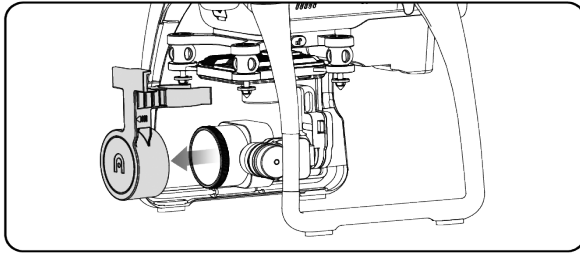

Reinstall the gimbal holder after using the aircraft to protect the gimbal from unwanted movements when not in use.

○ Preparing the Remote Controller

➤ To power up the remote controller

Press and hold the  button for 2 seconds until it lights up as solid green.

IMPORTANT

- Remove the aircraft wrapping from the four arms before powering on.
 - Power up the remote controller before turning on the aircraft.
-

➤ To power off the remote controller

Press and hold the  button for 2 seconds until you hear a short beep sound.

NOTE

The remote controller makes an alert sound after 15 minutes of inactivity, and turns off automatically after 30 minutes of inactivity.

When powering on/off the remote controller, you can check the CE/FCC standard on the upper left corner as shown below.

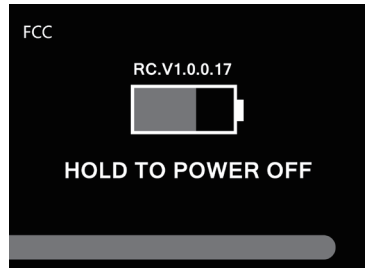
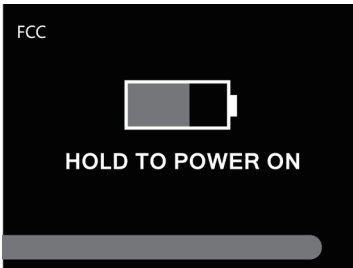

NOTE

The remote controller is made to comply with both CE and FCC standards. The system automatically chooses to comply with CE or FCC standard depending on the GPS locations.

Connecting Your Mobile Device

By connecting your mobile device to the aircraft, the X-Star mobile app **Starlink™** configures your mobile device to perform as a First Person View (FPV) monitor and a ground station for remote piloting, flight configuration and waypoint navigation.

The **Starlink™** app works on both iOS and Android smart phones and tablets. You can download it from our official website, Google Play or App Store.

Supported systems:

- iOS 8.0 or later (only compatible with iPhone 5 or later iPhone models)
- Android 4.0 or later

NOTE

Starlink™ will be updated regularly. Please check occasionally for latest updates.

➤ To connect your mobile device to the aircraft

1. Power up the remote controller and the aircraft successively.
2. Connect your mobile device based on your aircraft model.

For X-Star Premium:

Use a USB cable to connect your mobile device to the USB Port on the back of the remote controller.

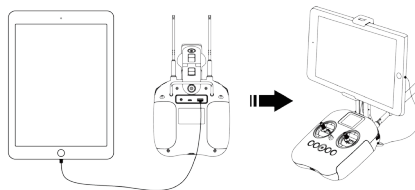

For X-Star:

Turn on the WiFi connection on your mobile device, select **X-Star_******* from the WiFi list, and enter the default password **99999999**.

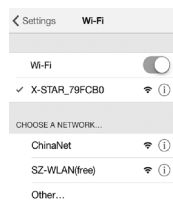

3. Launch the mobile app () on your mobile device. When the connection is successful, the **Home Page** of the app displays **Connected** in the upper left corner, and the **Flight Information Panel** on the remote controller displays **App Connected** in the **Flight Status Bar**.

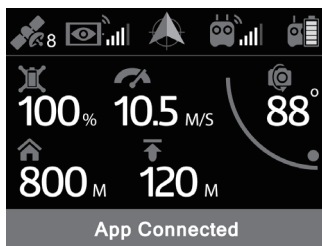

○ Calibrating the Compass

Make sure to calibrate the compass every time when flying in a new location. The rear 2 LEDs on the aircraft will show solid yellow light when the flight system detects compass deviation, indicating that you should change a place and calibrate the compass. If a drift occurs when the aircraft is hovering, the compass calibration is also necessary.



WARNING

The compass is very sensitive to electromagnetic interference that may cause compass error and poor flight. If you find the compass abnormal after calibration, move the aircraft to another location and try again.

Remember to meet the following requirements when carrying out compass calibration:

- Operate calibration outdoors (ideally on an open space such as a lawn).
- Be free from all magnetic interferences, such as magnetite or steel reinforcement found in concrete.
- Stay away from both underground and overhead power lines.
- Do not carry ferromagnetic materials (e.g., keys) with you.

➤ **To calibrate the compass:**

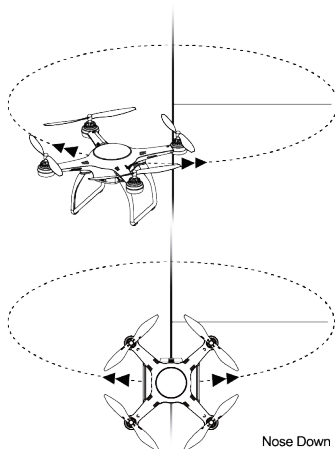

1. Begin calibration with your app: **Settings** () > **Flight Control Settings** () > **Compass Calibration**, and follow the on-screen instructions that help you monitor the calibration status. When the calibration process has been initiated, the 4 LEDs on the aircraft will flash yellow light.

2. Hold the aircraft horizontally by its arms and turn around until the 4 LEDs on the aircraft change into solid green light, which will switch to a flashing pattern later, ready for the next step.



3. Hold the aircraft vertically by its arms with the nose facing downwards and turn around until the 4 LEDs on the aircraft turn solid green, indicating that your calibration is successful.

NOTE

- When the mobile app displays instructions or alerts, please perform the required task in time to ensure your operation can be carried out successfully.
- You can also start the calibration process with the remote controller by pressing () and () simultaneously for 2 seconds. Then continue to perform Steps 2 and 3 to complete the procedure.

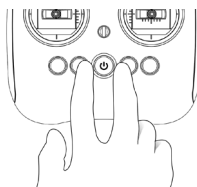

WARNING

- If the calibration is unsuccessful, the 4 LEDs on the aircraft will illuminate solid yellow light. In this case, repeat the above steps to try again.
- If severe drifting occurs during flight or the aircraft seems unstable for any reason, please land immediately.

Installing the Propellers

WARNING

Do not power up the aircraft while installing or removing the propellers.

! IMPORTANT

It is recommended to wear protective gloves when assembling or removing the propellers to protect you from the sharp edges. Use tools (e.g., wrench, plier, etc.) when necessary.

On each of the propellers there is one **Lock** icon and one **Unlock** icon indicating the rotate direction to fasten or unfasten the propellers.



Fasten the propeller by rotating the propeller in the indicated direction.



Unfasten the propeller by rotating the propeller in the indicated direction.

➤ To install the propellers

1. Match two of the propellers with red nuts to the corresponding motors with red paint, and the other two with silver/black nuts to the unpainted motors.

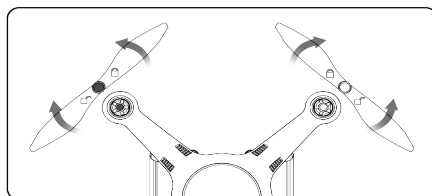

2. Fasten the propeller by rotating in the direction indicated by the  icon printed on the propeller.

➤ To remove the propellers

1. Power off the aircraft.
2. Unfasten the propeller by rotating in the direction indicated by the  icon printed on the propeller.

! IMPORTANT

- Check and ensure every propeller is stably mounted and in good condition before each flight. Do not use aged or damaged propellers.
 - Power off the aircraft before installing or removing the propellers. Keep off the propellers or motors when they are spinning. Remove the propellers when testing the motors' operation.
-

💡 TIPS

It is recommended to remove the propellers when the aircraft is not in use.

4

Flight Operations

After all pre-flight preparations have been done properly, take a few minutes to familiarize yourself with the controls of your **X-Star/X-Star Premium** by following the operation instructions described in this section before flying.

IMPORTANT

Before flying the **X-Star/X-Star Premium** aircraft, make sure those who operate or come into contact with this product have read and understood all safety instructions presented throughout this manual.

Preflight Checklist

Follow the steps below to carry out a full preflight check-up to maximize safety.

- The aircraft battery, the remote controller and the mobile device are fully charged
- The gimbal holder is removed.
- The propellers are properly installed and are in good condition.
- The antennas of the remote controller are unfolded and well adapted for a good position to obtain the best transmission quality ( 27).
- The aircraft and the remote controller are bound.
- The mobile app is properly installed and your mobile device is connected to the aircraft.
- The camera view on the X-Star mobile app is synchronized with the mounted camera.
- The firmware has been updated to the latest version.
- Familiarize yourself with the flight controls.
- Your flight area is an open, unobstructed and uncrowded area.

Remote Controller and Flight Operations

The remote controller has 2 command sticks designed for convenient remote flight controls for aerial maneuvers, including aircraft ascent/descent, left/right rotation, forward/backward and left/right sideway movements.

WARNING

When the GPS signal is not strong enough, the aircraft will not take off in GPS mode.

For the aircraft to receive maximum signal strength from the controller, position the two antennas so that they are parallel to each other and that their pointing direction is perpendicular to the direction of the aircraft's position, as shown in the images below.

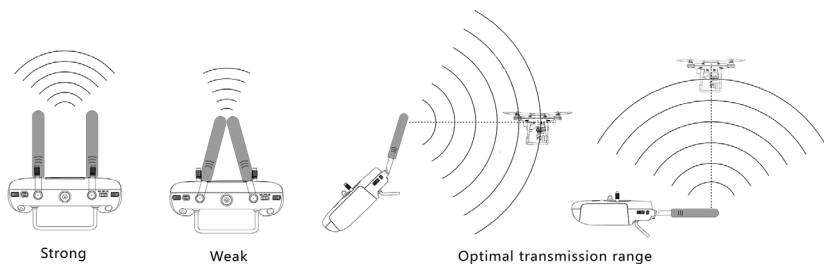

Motor Start-up and Take-off

Start the motors before commanding the aircraft to take off.

NOTE

The aircraft will not take off if the battery level is 15% or lower.

➤ **Start the motors in one of the following ways:**



Motor Starter:

Hold for 2s

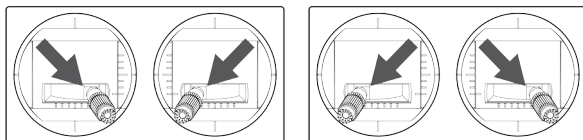

Both Command Sticks:

Hold toe-in or toe-out for 2s

- **When the motors are turned on, use one of the following methods to take off the aircraft:**



Takeoff/Landing Button:

Hold for 2s

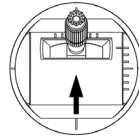

Ascent Stick:

push gently

If you command the aircraft to take off using , the aircraft will ascend automatically to a height of 4 meters.

 **NOTE**

 can only be activated after 3 seconds upon motor start-up, and does not work in ATTI Mode.

 **WARNING**

Do not block any of the air vents located beside the motors. Make sure the motors have cooled down completely before you touch it.

Command Stick Control

The aircraft reacts to the control of the command sticks through the RF transmission. The flight speed depends on the magnitude of the stick commands.

 **TIPS**

For beginners, it is recommended to move the command sticks lightly and slowly to keep the aircraft flying in a controllable speed.

● Left Command Stick

- A. Ascent/Descent** – commands the aircraft to ascend by pushing the stick upward, and descend by pushing it downward.

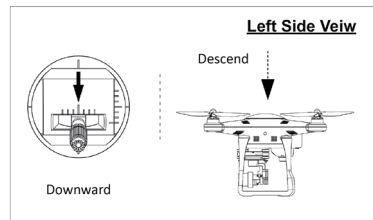
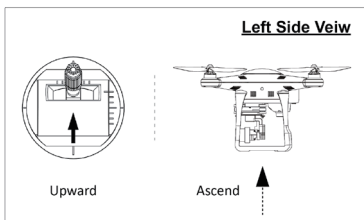

B. Rotate Left/Rotate Right – commands the heading of the aircraft to rotate left or right by pushing the stick left or right.

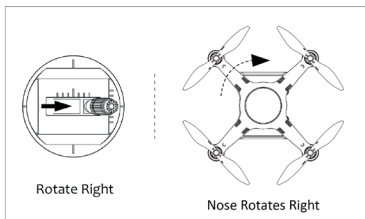
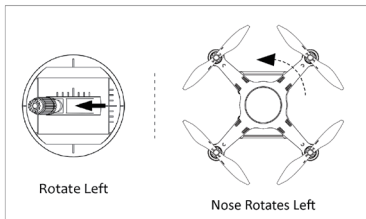

● **Right Command Stick**

A. Forward/Backward – commands the aircraft to move forward or backward by pushing the stick upward or downward.

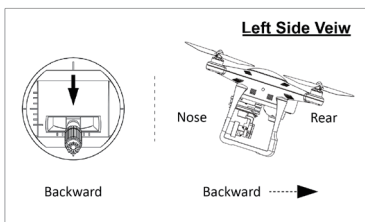
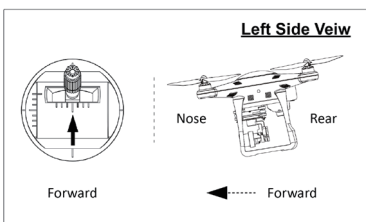

B. Move Left/Move Right – commands the aircraft to move left or right by pushing the stick left or right.

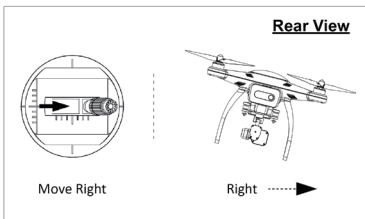
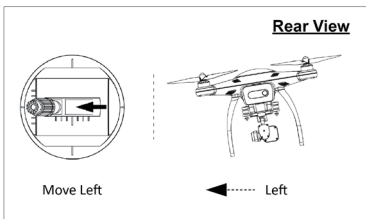

NOTE

The controls illustrated above are set as the default command stick mode (Mode 2). The left command stick controls aircraft ascent/descent and left/right rotation; The right command stick controls aircraft forward/backward and left/right sideways movements. You can change the control settings via the app: **Settings (⚙️) > RC Settings (📶) > Command Stick Mode.** (📖 52)

Smart Flight Features

● Intelligent Orientation Control (IOC)

To activate the **IOC** function during flight, slide the **Flight Mode Switch** at the side of the remote controller to the left.

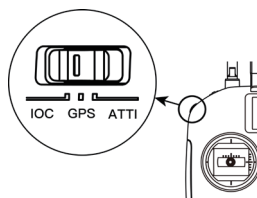

IOC mode is also known as Carefree Mode. It is used to keep the aircraft's direction controls locked regardless of its nose direction. It is most useful when you are unable to observe the nose direction of the aircraft. IOC works only in GPS mode.

Home Lock

The aircraft's forward/backward and leftward/rightward movements are locked parallel and perpendicular, respectively, to the line connecting the Home Point and the aircraft's real-time position regardless of the aircraft nose direction. You may push the right command stick forward or backward to adjust the distance between you and the aircraft, and push it left or right to command the aircraft to orbit you leftward or rightward at a set distance.

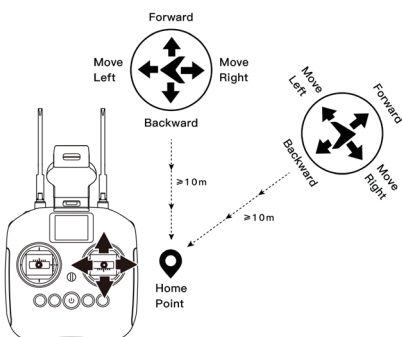

Course Lock

Once Course Lock is activated, the current nose direction is locked as the aircraft's forward direction. The aircraft will move in the locked directions regardless of its nose orientation (yaw angle).

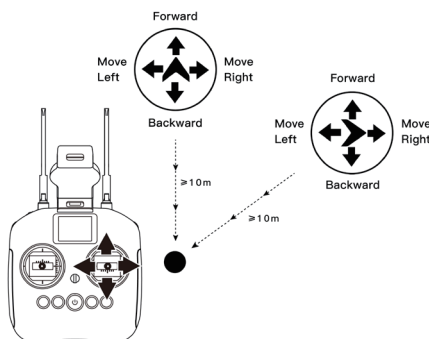



NOTE

- The flight direction is relative to the home point instead of the location of the pilot.
- **IOC** mode can only be activated when the aircraft is at least 10 meters away from you.

● Go Home



The **Go Home** function only works in **GPS** mode. To manually activate the **Go Home** function, you can press the **Go Home** button () on the remote controller.

When the **Go Home** command has been successfully received, the aircraft automatically maneuvers itself to return directly and land at the preset home point. Make sure there are no buildings or other obstacles in the flight path.

When **Go Home** is activated, the remote controller's functionality will be disabled temporarily while the aircraft returns to the home point. The remote controller's functionality can be regained during this period, allowing you to stop the aircraft Going Home when you consider it is safe.





IMPORTANT

- When the **Go Home** function is activated, for safety reasons, if the aircraft is hovering at the altitude lower than 30 meters, it will ascend to an altitude of 30 meters above the home point before starting to return. You can adjust the Go Home altitude in the app: **Settings** () > **Flight Control Settings** () > **Go Home Altitude** ( 50).
- If the **Go Home** function is activated within 10 meters radius from the home point, the aircraft will land automatically onsite.

➤ To manually regain control of the aircraft during Go Home procedure:

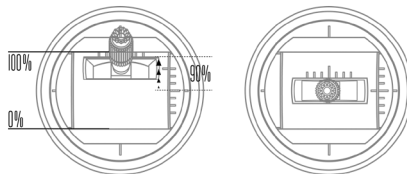
Push the **Ascent** stick to the position of 90% in range and hold for 2 seconds (illustration below as mode 2). The aircraft will stop flying towards the home point and may fly upward slightly when the remote controller control is recovered.



Alternatively, you can simply press the **Pause Button** () to regain control of your aircraft.

● **Failsafe**

The **Failsafe** function is designed to help your **X-Star/X-Star Premium** automatically return home or land onsite when necessary.

• **Communication Lost**

Failsafe will be triggered 5s after the communication between your aircraft and remote controller gets lost.

If GPS is available when **Failsafe** is activated, the aircraft will start the **Go Home** procedure automatically.

If GPS is unavailable (i.e. less than 6 satellites are found) when **Failsafe** is activated, the aircraft will hover for 10s. If 6 or more satellites are found during this period, the aircraft will start the **Go Home** procedure; otherwise, the aircraft will land onsite.

• **Low Aircraft Battery**

Failsafe will also be activated if one of the following low battery conditions are met.

- A. Your aircraft's battery constantly calculates the required battery level for the aircraft to return to the home point from its current location. When the battery level reaches the minimum level required for the aircraft to return to the home point, **Failsafe** will be activated and your aircraft will automatically **Go Home**. You can regain control of the aircraft during the **Go Home** process ( 31).
- B. Anytime your aircraft's remaining battery level reaches 25% (**Low Battery Warning**), **Failsafe** will be activated and your aircraft will automatically **Go Home**. If you choose to regain control during this process, the aircraft will automatically land onsite when the remaining battery reaches 15% (**Critical Low Battery Warning**). In this case, you may push the **Ascent** stick to stop the aircraft landing and command it to fly away from the current location for a safe landing in case of an emergency.

NOTE

- If the aircraft is only within 50m away from the home point when your aircraft's battery level reaches 25% (**Low Battery Warning**), the aircraft will not perform the **Go Home** procedure.
 - If GPS is unavailable when **Failsafe** is activated at **Low Battery Warning**, **Go Home** procedure will not be executed. In this case, the aircraft will land automatically when the remaining battery level reaches 15% (**Critical Low Battery Warning**).
-

● Starpoint™ Positioning System

The **Starpoint™ Positioning System** installed on the **X-Star/ X-Star Premium** aircraft functions through a **monocular camera** ① and two **ultrasonic sensors** ② on the bottom of the aircraft. The sensors help to identify the current height of the aircraft through ultrasound, and the camera obtains location information through image analysis. With the help of the **Starpoint™ Positioning System**,

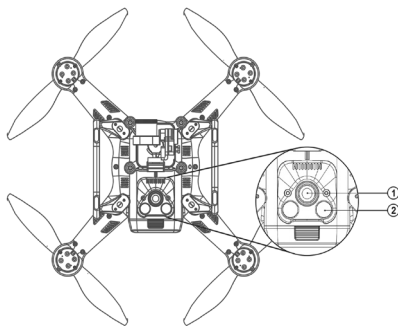

the aircraft can hover in place more precisely when flying indoors or in other environments where the GPS signal is unavailable.



NOTE

- The **Starpoint™ Positioning System** is activated by default when the aircraft is turned on.
- The **Starpoint™ Positioning System** works both in GPS and ATTI modes and is only valid when the aircraft is between 30cm and 300cm above the surface.



IMPORTANT

The performance of the **Starpoint™ Positioning System** is affected by the brightness and texture of the surface over which the aircraft is flying. The ultrasonic sensors may not function accurately above sound-absorbing materials. Please try to avoid the following situations:

- Flying over a monochrome surface (e.g. pure black, white, or red) or a highly reflective surface (e.g. water, transparent surfaces).
- Flying over extremely dark or bright surfaces, or in an area where the lighting changes frequently.
- Flying over surfaces with unclear patterns or texture, or highly repeating patterns or texture (e.g. tiles with the same design).
- Flying over surfaces (e.g. thick carpet) that can absorb or deflect sound waves.
- Flying at a high speed: over 8m/s at a 2-meter height, or over 4m/s at a 1-meter height.
- Flying over moving surfaces or objects.

TIPS

- Always keep the monocular camera lens clean for a clear view.
 - Do not use other 40KHz ultrasonic devices nearby when the **Starpoint™ Positioning System** is activated.
-

Landing and Motor Shut-down

The aircraft can be landed manually, automatically, or passively.

IMPORTANT

The aircraft must be landed gently on a flat surface to avoid damage.

● Manual Landing

You can manually land the aircraft whenever and wherever you want by maneuvering the command sticks on the remote controller.

➤ To land the aircraft manually

1. Maneuver the aircraft to the desired position for landing.
2. Release the command sticks when the aircraft reaches the target position to let it hover.
3. Push the **Descent** stick steadily and gently to land the aircraft.

➤ To shut down the motors

When the aircraft has properly landed, use one of the methods below to shut down the motors:

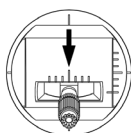

Descent Stick:

Push to the end and hold for 2s

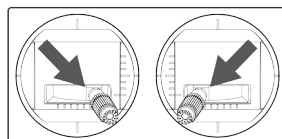

Both Command Sticks:

Hold toe-in for 2s

WARNING

The toe-in action will always shut down the motors even if the aircraft is in midair. Please be extra cautious and use this feature only in an emergency, e.g., when the aircraft gets out of control.

● Automatic Landing

You can use the () button on the remote controller to land the aircraft automatically from its current hover position with one single click.

➤ To land the aircraft automatically with the () button:

1. Maneuver the aircraft to the desired position for landing.
2. Release the command sticks when the aircraft reaches the target position to let it hover.
3. Press and hold the () button for 2 seconds until you hear a beep sound.
4. The aircraft will descend to land and shut off its motors automatically. During descent, you will also have control of the pitch, roll and yaw adjustments.

TIPS

During the automatic descent process, you can regain control by pushing the **Ascent** stick to at least 90% level and maintaining for 2 seconds. ( 31)

NOTE

- Automatic landing is also available in ATTI mode but you should control the attitude of the aircraft manually.
- It is recommended that you land the aircraft immediately when Low Battery Warning (25% or lower) is shown, i.e., the rear LEDs on the aircraft flash red light, and the () button on the remote controller lights up in solid yellow light.

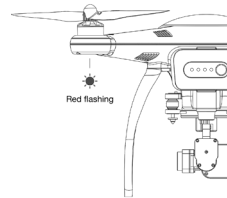

● Passive landing

When Failsafe is triggered by any of the following conditions, the aircraft will be forced to land onsite automatically.

- **Low Battery Warning** is activated in non-GPS environment.
- **Critical Low Battery Warning** is activated.

○ Using the Starlink™ App

The **X-Star/X-Star Premium** application, **Starlink™**, is a full-featured program

designed for aircraft control, flight data review, remote camera shooting, preset-waypoint navigation, general settings and so on. Your mobile device will perform as the central monitor for remote piloting control, aerial photographing and filming, and flight parameter tuning to achieve optimal flight performance.

Home Page



FLIGHT RECORD

View detailed record of all your flights such as time, distance and actions taken.



ACADEMY

View documents and videos, such as Packing List, Quick Guide, User Manual and Guided Tour.



LEARN MORE

Slide the center of the screen to find the aircraft you wish to learn more about and tap on it to get more information.



MEDIA

View and edit the photos and videos that you have downloaded.



STORE

Enter Autel Robotics' online store where you can purchase the products and accessories.



ME



Register or log into your Autel Robotics account.

How to Connect

Slide the center of the screen to choose your aircraft and tap this button to follow the pop-up instructions to connect your mobile device. When your connection is successful, this button turns to green and displays **Connected**.

NOTE

When your aircraft is used for the first time, you will be guided to the registration page after the connection is completed. Please follow the on-screen instructions to activate your **X-Star/X-Star Premium**:

1. Create an account and set a password for your account.
2. Name your **X-Star/X-Star Premium**.
3. Select a **Command Stick Mode**, **Parameter Unit** and **System**.
4. Confirm that the **Beginner Mode** is enabled. This mode is enabled by default when you use the product for the first time, and you may disable **Beginner Mode** through the app: **Settings** () > **Flight Control Settings** () > **Beginner Mode** ( 49).

START

Enter the camera screen for a **First Person View**.

When your mobile device has been connected to the aircraft, the system will run a self-check to ensure it is safe to fly. You can check the overall status in a prompted window and eliminate the abnormal conditions before your flight.

First Person View (FPV)

This interface synchronizes your screen display with the on-board camera for a real-time first person view, allowing you to perform various camera operations and configurations for aerial photography.

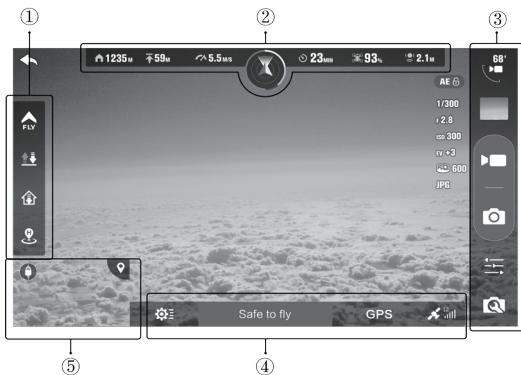

- ① Flight Control Panel
- ② Aircraft Status Bar
- ③ Camera Operation Panel

- ④ General Information Bar
- ⑤ Map Split Screen

● Flight Control Panel



AUTOPILOT FUNCTIONS

Command the aircraft to fly automatically according to the intelligent flight mode you have selected, including Orbit, Follow and Waypoint modes. ( 42)



TAKE OFF / LAND

Command the aircraft to take off or land.





GO HOME

Command the aircraft to return to the specified home point.



SET HOME POINT

Choose a new location as your home point. Options include the location where you are standing () and the real-time location of the aircraft when you tap this icon (). The app will prompt a notification when the home point reset is successful.

● Aircraft Status Bar



DISTANCE

The horizontal distance between the aircraft and the home point.



ALTITUDE

The altitude of the aircraft relative to the home point level.



FLIGHT SPEED

The current flying speed of the aircraft.



REMAINING TIME

The remaining time for the aircraft to fly.



BATTERY LEVEL

The current battery level of the aircraft.



STARPOINT™ POSITIONING SYSTEM

The distance between the surface and the **Starpoint™ Positioning System's** sensors. This icon is highlighted only when the **Starpoint™ Positioning System** is in working state.



FLIGHT STATUS

- The arrow indicates the yaw angle of the aircraft's nose.
- The colored ring indicates the current battery level of the aircraft. The green bar is present when there is abundant battery. The yellow bar indicates the battery level reaches the minimum required to Go Home. The red bar means the battery level reaches the minimum required to land onsite.

● Camera Operation Panel



PITCH CONTROL BUTTON

Tap this button to open the **Pitch Scroll Bar** which you can scroll up and down to control the camera pitch movement. A camera pitch angle indicator will show up accordingly on the upper right corner of this button.



PLAYBACK BUTTON

This icon displays the most recent photo/video taken. You may tap it to view and download/delete your photos and videos one by one or in groups.



RECORD BUTTON

Tap this button to record a video. Tap it again to stop recording. **Video Settings** are available in ().



SHUTTER BUTTON

Tap this button to take a photo. **Photo Settings** are available in (). Before taking a photo, select a shooting mode (Single Shot, Burst Shooting, AEB, Time Lapse) from **Photo Settings**. This icon may appear differently depending on different shooting modes you have chosen.







ADVANCED CAMERA SETTINGS

Automatic Settings () allows you to adjust **EV**; Manual Settings (**M**) allows you to adjust **ISO** and **Shutter Speed**.



CAMERA SETTINGS

Perform **Photo Settings** (), **Video Settings** () and **Camera Settings** ().

 (* default value)	
Mode	*Single Shot, Burst Shooting (3/*5/7), AEB (*3/5), Timelapse (*5/7/10/20/30)
Size	*4000×3000 (4:3), 4000×2250(16:9)
Format	*RAW, DNG, RAW+DNG
Style	*Standard, Soft, Landscape, Custom
WB	*Auto, Sunny, Cloudy, Incandescent, Neon
Color	*None, Nostalgia, Art, Beach, Classic, Vivid, Dream, Film, Log, B&W

 (* default value)	
Resolution	4096×2160p 24/25, *3840×2160p 24/25/30, 2704×1520p 24/25/30/48/50/60, 1920×1080p 24/25/30/48/50/60/120, 1280×720p 24/25/30/48/50/60/240
Standard	*NTSC, PAL
Format	*MOV, MP4
Style	*Standard, Soft, Landscape, Custom
WB	*Auto, Sunny, Cloudy, Incandescent, Neon
Color	*None, Nostalgia, Art, Beach, Classic, Vivid, Dream, Film, Log, B&W

 (* default value)	
Histogram	ON, *OFF
Over Exposure Warning	ON, *OFF
Subtitle. SRT Files	ON, *OFF
Anti-Flicker	*Auto, 50Hz, 60Hz
Grid	*None, Grid Lines, Grid+Diagonals, Center Point
File Index Mode	Continuous, *Reset
Reset Settings	ON, *OFF
Format SD Card	ON, *OFF
Version	Displays the current version of the camera



NOTE

Please format the SD card only via the **Starlink™** app. The camera may not be able to recognize the SD card if you format it using other devices.

 **WARNING**

The **Format SD Card** option in **Camera Settings** will format the inserted SD card. Make sure to back up your files beforehand. For whatever reasons, Autel Robotics will not be responsible for any unrecorded or unreadable image or video.

● **General Information Bar**



SETTINGS

Tap this icon to open the **Settings** page where you can manage **Flight Control, Remote Controller, Video Link, Aircraft Battery, Gimbal** and **General Settings**. (📄 49)



SYSTEM STATUS

Displays the real-time status of your aircraft.



FLIGHT MODE

The information displayed on this icon varies depending on the current flight mode of the aircraft, including GPS, ATTI, IOC, Follow, Orbit, Failsafe, etc..



GPS SIGNAL

Displays the current GPS signal strength.

● **Map Split Screen**

In the FPV interference, you will see a smaller split screen at the bottom left displaying the map of the surrounding area of your aircraft. Tap on this screen to switch to the map view as shown below.

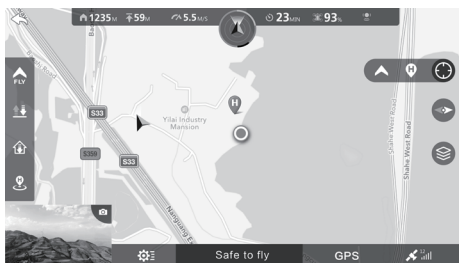

To view different areas, you can zoom in, zoom out or drag the map.



The three function icons on the right provide different options for you to view the map:

Icon	Name	Function
	Location	Choose the area around the home point.
		Choose the area around the aircraft's location.
	Compass	Lock/unlock the compass of the map.
	Map View	Choose a map view from Normal , Hybrid and Satellite view.

Autopilot

The **Autopilot** function includes a series of smart flight modes that command your aircraft to fly in a specific pattern automatically, providing a carefree piloting experience for you. Tapping () leads you to the Autopilot options below. The () button on the upper right corner grants access to the instructions for each mode:

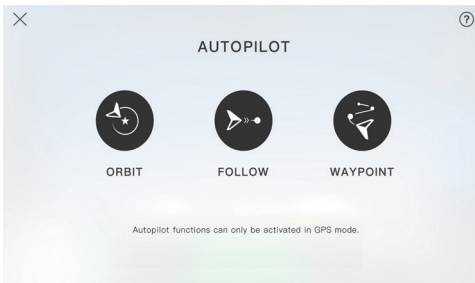

IMPORTANT

During Autopilot Mode, please always keep a clear path for the aircraft as it cannot avoid obstacles that come into the flight path autonomously.

● Orbit Mode

When **Orbit** mode is activated, the aircraft flies in a circle with the camera fixed on a point of interest (POI). Please follow the app to perform **Orbit**:

1. Choose a POI you prefer from below:



- **Aircraft:** The current location of the aircraft
 - **Me:** Your current location
 - **New:** Pin a new point within a safe round zone displayed on the map
2. Follow one of the methods below to set the orbit radius before starting the program.
- A. Move your aircraft from the current location **O** to your desired location **R** to set the orbit radius.

POI	Orbit Radius
Aircraft	Distance between O and R .
Me	Distance between you and R .
New	Distance between R and the point you choose on the map.

- B. Tap on the top box in the right panel on the screen to input a number to manually adjust the orbit radius between the aircraft and the POI. Then decide the laps, the orbit direction (**CW/CCW**), and whether the aircraft is to **Hover** or **Go Home** when **Orbit** is finished. The aircraft will automatically face the POI when you initiate **Orbit** mode. You can still control the camera any time you wish. Click **Start** when ready.

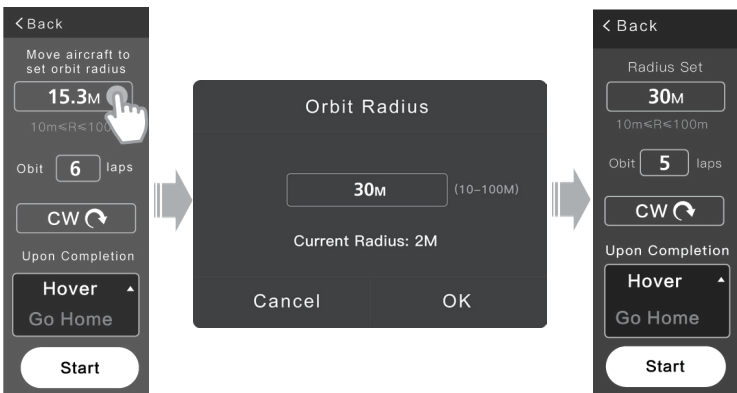

3. A **Go Home Altitude** setting will pop up for you to set a safe altitude for the aircraft to perform **Go Home** at low battery level. Once you click **OK**, your aircraft will initiate Autopilot.



4. Use the left and right command sticks to adjust the position of the aircraft as illustrated on the right side of the screen. You can change the orbit direction (**CW/CCW**) or turn the aircraft's nose towards the POI (**Face POI**).

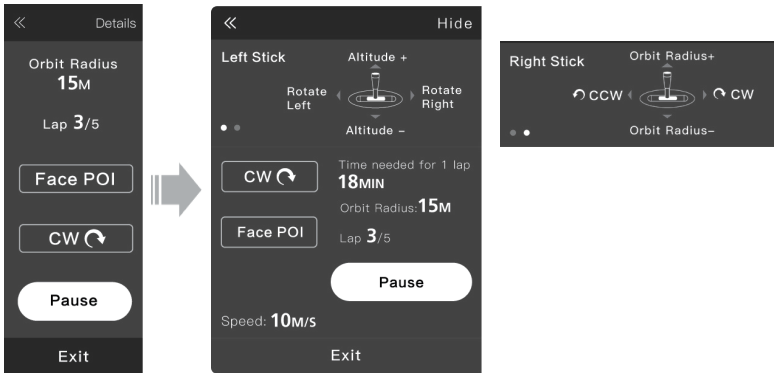

5. Tap **Pause** to let the aircraft hover, or tap **Exit** to exit **Orbit** mode.



NOTE

- The orbit radius can only be set between 10m and 100m. When flying within 10m or beyond 100m radius centering the POI, the aircraft will adjust its orbit radius to 10m and 100m respectively.
- Pressing the **Pause Button** on your remote controller will also command the aircraft to hover. Tap it again to resume the flight.

Follow Mode

In Follow mode, the aircraft tracks you as you move with its nose pointing at you. The speed will depend on your moving speed but cannot exceed the flight speed you set in the app: **Settings** (⚙️) > **Flight Control Settings** (🛩️) > **Flight Speed**.

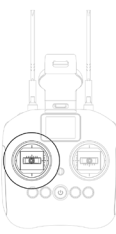
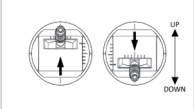
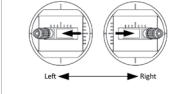
The table below illustrates how to control the relative position of the aircraft using the remote controller during Follow mode.

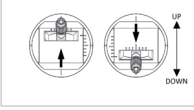
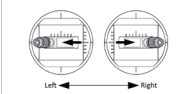
		Adjust the altitude of the aircraft.
		Change the direction of the aircraft's nose.
		Adjust the distance between you and the aircraft.
		Command the aircraft to follow you in a circular course leftward or rightward.



NOTE

- **Follow** mode is valid within 100 meters radius centering the mobile device. However, the aircraft will not turn its nose towards the mobile device when the horizontal distance between them is less than 3 meters.
- You can choose a location (your current position or the initial home point) for your aircraft to return to when **Failsafe** is activated in **Follow** mode.
- Pressing the **Pause Button** on the remote controller will exit from **Follow Mode**.



IMPORTANT

- **Orbit** and **Follow** modes cannot be activated when the aircraft is less than 10 meters high above the home point. Once you have activated **Follow** or **Orbit** mode, the altitude limit will be cancelled.
- In **Follow** or **Orbit** mode, if the GPS signal of your mobile device is too weak, the aircraft will switch to hover mode until the GPS signal quality becomes acceptable again. Follow/Orbit mode will be cancelled automatically after 15 seconds of poor GPS reception of the mobile device.

● Waypoint Mode

This mode allows the aircraft to fly in a preset route according to the waypoints you have set. You can command the aircraft to fly along the route you have saved in **Favorites**, or create a new route.

! IMPORTANT

For **X-Star Premium**, you can use this function directly and the map will be downloaded automatically. For **X-Star**, if you use the app on an Android mobile device, you need to download the map before using this function for the first time; this is not necessary if you use an iOS device, as the iOS system allows simultaneous connection with the aircraft self-generated WiFi network and the 3G/4G network.

➤ To download the map on X-Star

1. Disconnect your mobile device from the X-Star WiFi network.
2. Connect your mobile device to the Internet and enter the map from Map Split Screen to download the map.
3. Reconnect your mobile device to the X-Star WiFi network and come back to this function.

➤ To perform Waypoint mode

1. Choose one of the following 3 ways to set up your waypoints.
 - **Aircraft** - Select **Aircraft** from the drop-down box of **Waypoint Location**. Move your aircraft to a target position and tap **Mark Waypoint** to set it as one of your waypoints. The rest of your waypoints can be done in the same manner. The **Delete Waypoint** button is used to remove the last waypoint you set. When you have confirmed all the waypoints, tap **Finish**.



- **Draw on Map** - Select **Draw on Map** from the drop-down box of **Waypoint Location** and your screen will be switched to the map. Move your finger to draw a route on the map, and the waypoints will be identified automatically according to your route. The **Clear**

Waypoints button is used to delete the entire route. When you have confirmed your route, tap **Finish**.

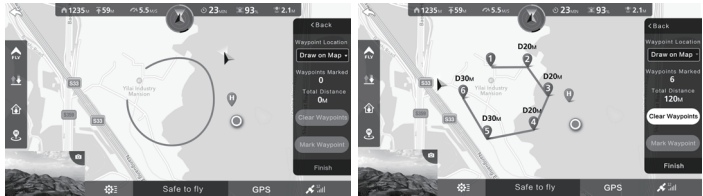

- **Point on Map** - Select **Point on Map** from the drop-down box of **Waypoint Location** and your screen will display the map. Tap on the map to pin down up to 15 waypoints and they will be linked automatically as a route. Tapping **Delete Waypoint** can remove the last waypoint you pinned down. When you have confirmed all the waypoints, tap **Finish**.



NOTE

To edit a selected waypoint before **Finish**, tap on the waypoint you wish to edit and **Waypoint Settings** will pop up. You can then set the waypoint altitude, hover duration, and decide whether to delete the waypoint.

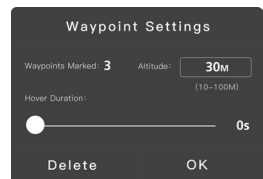

2. Decide whether the aircraft will **Hover** or **Go Home** upon task completion, and tap **Start**.



3. Set a safe altitude for the aircraft to perform **Go Home** at low battery level.



4. When the aircraft is performing a **Waypoint** mission, you may adjust the aircraft's speed with the right command stick and command its nose to face next waypoint with the **Face Next Waypoint** button. The **Exit** button is used to exit this mode. Tapping (☆) on the upper right corner will save the current route into **Favourites**.





 **NOTE**







Pressing the **Pause Button** on your remote controller will also command the aircraft to hover. Tap it again to resume the flight.

TIPS

To terminate the **Waypoint** mission at any point, perform one of the following actions:

- Regain control of the aircraft by sliding the **Flight Mode Switch** on the remote controller to **ATTI** position. (Only available when **ATTI** is enabled on the app) The aircraft will terminate the mission and respond to the remote controller.
 - Press () on the remote controller and hold for 2 seconds. The aircraft will terminate the mission and land at the home point.
 - Push the **Ascent** stick to the position of 90% in range and hold for 2 seconds. This is the same with the method to regain control of the aircraft during **Go Home**. ()
-

Settings

Tapping the Settings icon () on the **General Information Bar** allows you to adjust 6 categories of settings displayed on this menu, including **Flight Control Settings** (), **Remote Controller Settings** (), **Video Link Settings** (), **Aircraft Battery Settings** (), **Gimbal Settings** () and **General Settings** ()

● Flight Control Settings

In **Flight Control Settings**, you can manage the following settings:

1. **Compass Calibration** () 23
2. **Beginner Mode**

Slide this button to enable or disable **Beginner Mode**. This mode has a fixed maximum flight altitude (30m), distance (100m) and speed (horizontal: 6m/s, ascent: 4m/s, descent: 1m/s) designed to keep beginners' flights safe.

NOTE

When **Beginner Mode** is activated, the motors cannot be started in non-GPS mode.

3. Flight Speed

Set a horizontal speed when **Beginner Mode** is disabled. (default: 15m/s)

4. Altitude Limit

Set a maximum altitude for your flight when **Beginner Mode** is disabled to

protect the aircraft from losing signal or flying out of sight. (default: 120m)

5. Distance Limit

Slide this button to enable or disable the default distance limit (800m) when **Beginner Mode** is disabled.

NOTE

When the altitude and distance limits are determined, the aircraft cannot fly outside the preset boundaries under GPS mode. In non-GPS mode, the aircraft is only restricted to the preset altitude limit; the distance limit under non-GPS mode may vary depending on the regulations and laws in different areas and countries.

6. Go Home Altitude

Set a safe altitude for your aircraft to **Go Home** automatically in case of an emergency. If you set the **Go Home Altitude** to a certain value, the aircraft will adjust its altitude to this value before returning to the home point. The default **Go Home Altitude** is 30m.

7. Advanced Settings

- **Enable ATTI Mode**

Switch this button on so you can activate **ATTI** mode on the remote controller directly, as this mode is disabled by default to prevent accidental disabling of GPS mode.

- **IOC Mode**

Choose from **Home Lock** and **Course Lock**. ( 30)

- **Front LED Indicator Lights**

Slide this button to turn on or turn off the two red front LED indicator lights. These LEDs help you to identify the aircraft's nose direction during flight.

- **Read Flight Data**

Connect your aircraft to a computer with a USB cable to read the flight data. Then you need to reboot the aircraft before use.

- **Remote Controller Settings**

The **Remote Controller Settings** function grants access to Gimbal Pitch Dial Speed, RC Binding, RC Calibration, Command Stick Mode and RC Language Settings and Teaching Mode.

1. Gimbal Pitch Dial Speed

Slide the scroll bar left or right to adjust the speed of the **Gimbal Pitch Dial** on the remote controller.

2. RC Calibration

This function includes the calibration of the **Left Command Stick**, **Right Command Stick** and **Gimbal Pitch Dial**. You will only need to calibrate your remote controller when using it for the first time or after your remote controller has been replaced.

The horizontal bar on the upper part of the screen represents the Pitch Control Dial, and the two crossed bars on the sides represent the left and right command sticks.

➤ To calibrate the remote controller

- I. Release the two command sticks and the Gimbal Pitch Dial to their central position and tap **Start**.

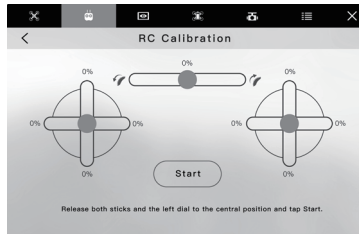

- II. Push both command sticks and turn the Gimbal Pitch Dial to their complete range of motion. The progress bars will be in response to your calibration. Below is an example for illustration.

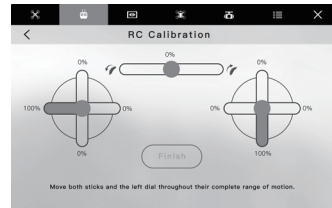
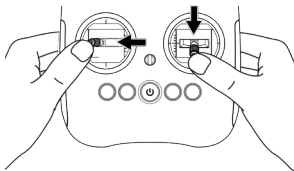

- III. After each bar has been highlighted 100%, tap **Finish** and your remote controller calibration is completed.

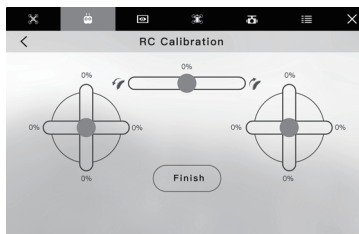

3. RC Binding

Press the **Bind** button and then hold the **RC Binding Button** on the aircraft for 3s as instructed on the app to bind your aircraft and remote controller. You will be prompted when this is done successfully.

4. Command Stick Mode

Choose a command stick mode to control your aircraft. There are 3 modes available: Mode 1, Mode 2 and Mode 3, controlling the aircraft in different manners. Below are the illustrations of these 3 modes.

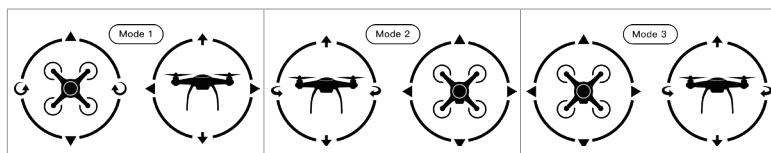



Indicator Icons		Aircraft Movement	
↑	↓	Ascend	Descend
↶ / ↷	↷ / ↶	Nose rotates left	Nose rotates right
▲	▼	Move forward	Move backward
◀	▶	Move left	Move right

5. RC Language

Set the language displayed on the LCD **Flight Information Panel**.

6. Teaching Mode

This mode creates a simultaneous connection between an aircraft and two remote controllers for teaching purposes. One of the remote controllers (which is bound with the aircraft) is set as **Learner**, and the other is set as **Instructor**. When **Instructor** is operating, **Learner's** functions will be disabled automatically (excluding the **Gimbal Pitch Dial**). This helps **Instructor** to demonstrate the operation methods and gain control of the aircraft from **Learner** in an emergency.

To activate **Teaching Mode**, connect two remote controllers with a CAN cable, and designate them on the app respectively. To designate the remote controller as **Learner**, connect your mobile device to the remote controller bound with the aircraft and tap the **Learner** button on the app (**Settings**  > **Remote Controller Settings**  > **Teaching Mode**). To designate the other remote controller as **Instructor**, disconnect your mobile device from **Learner** and connect it to the other remote controller, or use another mobile device to connect it, then tap the **Instructor** button on the app. **Instructor** and **Learner** can

be set in a random order.

 **NOTE**

To connect your mobile device and the remote controller, you need to use WiFi for **X-Star** and a USB cable for **X-Star Premium**.
( 22)

● **Video Link Settings**

For the **X-Star**, you can rename the WiFi SSID and reset the password in this section.

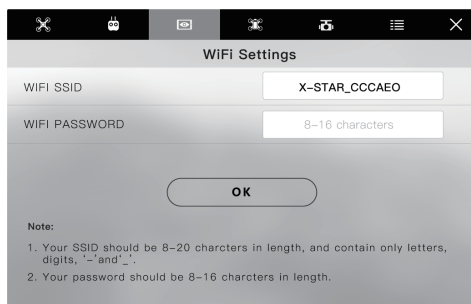

 **NOTE**

To reset the WiFi video link, toggle the **Flight Mode Switch** back and forth quickly for at least 4 times. The remote controller will make a beep sound when the WiFi SSID and password have been reset to the default values.

For the **X-Star Premium**, you can check the noise condition of each channel and choose the one with minimum noise.

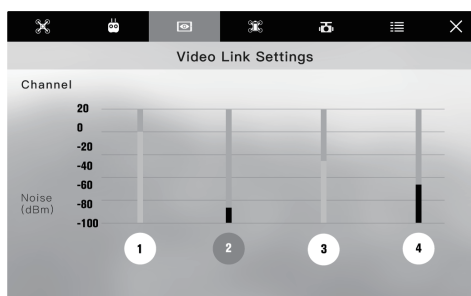

● **Aircraft Battery Settings**

You can also enter this section by tapping () on the **Aircraft Status Bar**. This function allows you to view the current status and general information of the aircraft battery. **Low Battery Warning** and **Critical Low Battery Warning** settings are also available in this section.

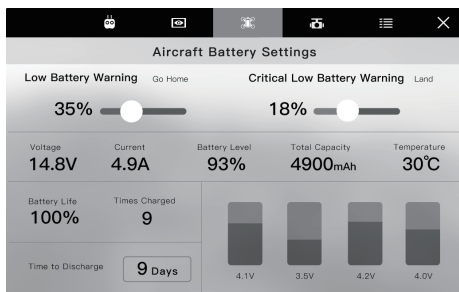

 **NOTE**

For your own safety, the **Low Battery Warning** cannot be set below 25%, i.e., the minimum battery level for Go Home; and the **Critical Low Battery Warning** cannot be set below 15%, i.e., the minimum battery level for landing.

● **Gimbal Settings**

This section allows you to adjust gimbal settings.

1. **Gimbal Mode**

Choose a working mode for your gimbal from **Stabilized** mode and **PFV** mode. ( 8)

2. **Adjust Gimbal Roll**

You can adjust the roll axis of your gimbal slightly while watching the camera view to find the best angle for your photography.

● **General Settings**

1. **Parameter Unit**

Choose your preferred unit system: **Imperial** or **Metric**.

2. **Beginner Guide**

Slide this button to display or hide the Beginner Guide.

3. **Map**

- **Show Flight Route**

Slide this button to display or hide your flight route on the map.

- **Calibrate Coordinates (For Mainland China)**

Slide this button to enable or disable the map calibration.

- **Background Caching**

Slide this button to enable or disable map caching in the background.

- **Clear Flight Route**

Clear your flight route on the map.

4. **YouTube Live Streaming**

Slide this button to enable or disable the real-time YouTube streaming.

5. **Firmware Version**

View the firmware version of different components.

6. **About**

View your **Starlink™** version.

5

Maintenance and Service

Firmware Upgrade

To optimize the performance of your **X-Star/X-Star Premium**, firmware updates will be provided on a regular basis. You can download the latest firmware (Flight Control, Gimbal, Camera, Remote Controller, etc.) in one package from our official website. When a firmware update is available, you will be prompted by the app once it is connected to the aircraft.

IMPORTANT

Before updating, please make sure:

- The four motors have stopped completely.
- The battery level of both your aircraft and remote controller is not less than 50%.
- There is enough space available in your camera's SD card to store the firmware upgrade data.

➤ To download and upgrade the firmware

1. Download the all-in-one firmware upgrade package (with a .zip file extension) from Autel Robotics' official website: www.autelrobotics.com.
2. Insert the SD card into your computer and extract the downloaded file (into a .bin file extension) into your SD card. Then remove your SD card from the computer.
3. Turn on the remote controller and aircraft.
4. Insert the SD card into the aircraft to start the upgrade process automatically.

NOTE

You can check the real-time upgrade status on the **Flight Information Panel**. The entire upgrade process will be completed only when both the aircraft and remote controller have been upgraded successfully, as shown on the Panel.

5. Reboot the remote controller and aircraft before use.

NOTE

- Do not turn off any device or take out your SD card from the camera during the process. Do not start the motors.
- After the upgrade is completed, the remote controller may be disconnected from the aircraft, and you will need to rebind the devices.

Troubleshooting Tips

Should you have any issues operating the product, read this section for possible solutions.

When the aircraft indicates failure during self-check (*with 4 LED lights flashing quickly in red and the buzzers beep continuously*)

- Hardware problems detected and you need to contact the Customer Service

When the aircraft motors fail to start up

- Check if the remote controller and the aircraft are properly bound
- Check if the remote controller is properly calibrated
- Check if the battery level is below 15%
- Check if the compass is experiencing interference
- Make sure the **Flight Mode Switch** is not in the **GPS** position if the GPS signal is not strong enough
- Make sure GPS is available when Beginner Mode is activated

When take-off fails after motors start

- Check if the aircraft is in a no-fly zone
- Make sure the aircraft is placed on a flat, leveled surface

When the aircraft's flight time reduces

- This is possibly due to low temperature of the operating environment or increased take-off weight

When pairing up, the aircraft does not respond to the remote controller

- Make sure there are no metal objects, wireless sources or other remote controllers around

If Video link fails or disconnects frequently

- Make sure your aircraft and remote controller are free from all magnetic or signal interferences

If the camera is powered off during video recording

- Keep the Micro-SD card inside the camera. Restart the camera and wait until the video files are recovered (partial data may be lost)

If acquisition of the WiFi SSID fails

- Check if both the aircraft and the remote controller are powered on
- Make sure WiFi is enabled on the mobile device

If the aircraft is out of sight and the video link is lost

- Activate **Go Home** procedure to have the aircraft automatically return or activate **IOC** procedure (**Home Lock**) to manually navigate it to return

If the mobile app is accidentally closed when the aircraft is executing a Waypoint mission

- If the app is closed when the flight mission is under execution, the aircraft will continue to execute the given command
- You can regain control of the aircraft with the remote controller manually at any time

Storage and Maintenance Instructions

To ensure optimum performance of the product, we advise you read and follow the maintenance instructions in this section carefully.

- Keep the devices in a clean, dry and ventilated environment within normal operating temperatures.
- Keep the devices out of sunlight when not in use
- Dry your hands before using the devices.
- Use a soft cloth with alcohol or a mild window cleaner to clean the lens of the camera, instead of any abrasive cleansers, detergent or chemicals.
- Ensure that the battery charger does not come in contact with conductive material.
- Avoid dropping your devices, especially on a hard surface. Check it in detail after any crash or impact, and contact a local Autel Robotics agent in time if you have any problem.
- Only use the battery chargers or other accessories authorized by Autel Robotics. Failure to do so may void the warranty.

Customer Service

This section contains information regarding technical support, repair service, and

application for replacements or optional parts.

Technical Support

If you have any questions or concerns regarding our products, please contact us by:

- Telephone: (844)-898-0290 (U.S.A.)
- Email: support@autelrobotics.com
- In person: local distributors or agents

Repair Service

If it is necessary to return your device for repair, please fill in and submit the repair service form on <http://www.autelrobotics.com>. The following information is required:

- Contact name
- Email address
- Mailing address
- Telephone number
- Product name
- Complete description of the problem with photo attachments
- Proof-of-purchase for warranty repairs
- Preferred method of payment for non-warranty repairs

Autel Robotics' support team will review your application within 72 hours after receiving your application. After a preliminary evaluation of the problem, our customer support will contact you for further updates or follow-ups.

6

Warranty

Autel Robotics (the Company) warrants to the original retail purchaser of this product, that should this product or any part thereof during normal consumer usage and conditions, be proven defective in material or workmanship that results in product failure within the valid warrant period from the date of purchase, such defect(s) will be repaired, or replaced (with new or refurbished parts or products) at the Company's option, with Proof of Purchase, without charge for parts or labor directly related to the defect(s). Some states do not allow limitation on how long an implied warranty lasts, so the above limitations may not apply to you.

The Company shall not be liable for any incidental or consequential damages arising from the use, misuse, or mounting of the device. The extent of Autel Robotics' liability under this warranty is limited to the repair and replacement provided above and, in no event, shall its liability exceed the purchase price paid by purchaser for the product.

Please visit www.autelrobotics.com for details of the limited periods warranted for the different parts of this product.

This warranty does not apply to:

- Batteries that cycle-charged for more than 200 times;
- Products subjected to abnormal use or environmental conditions, accident, mishandling, neglect, unauthorized alteration, misuse, improper installation or repair, or improper storage;
- Products with signs of tempering or altering of the serial number label, waterproof mark, etc.;
- Damage resulting from connection to, or use of any accessory or other product not approved or authorized by the Company;
- Defects in appearance, cosmetic, decorative or structural items such as framing and non-operative parts.
- Products damaged from external causes including but not limited to fire, water, dirt, sand, battery leakage, blown fuse, theft or improper usage of any electrical source.

Regulatory Compliance and Flight Restricted Area

Compliance and Advisory

FCC Compliance

This device complies with Part 15 of the FCC rules. Operation is subject to the following two conditions: (1) This device may not cause harmful interference, and (2) this device must accept any interference received, including interference that may cause undesired operation.

FCC Radiation Exposure Statement

This device abides by FCC radiation exposure limits releasing for an uncontrolled environment. The minimum distance between the radiator and the user is designed to be 20cm when the aircraft and its accessories are in function. It is also forbidden to co-ordinate any other transmitter or antenna with this transmitter in use.

Autel Robotics announces that the X-Star and X-Star Premium are in compliance with the essential requirements and other relevant provisions of Directive 1995/5/EC.

IC RSS Warning

This device complies with Industry Canada license-exempt RSS standard(s). Operation is subject to the following two conditions: (1) This device may not cause harmful interference, and (2) this device must accept any interference, including interference that may cause undesired operation of the device.

IC Radiation Exposure Statement

This equipment complies with IC RF radiation exposure limits set forth for an uncontrollable environment. This transmitter must not be co-located or operating in conjunction with any other antennas or transmitter. This equipment should be installed and operated with at least 20cm between the radiator and your body.

Any changes or modifications not expressly approved by the party responsible for compliance could void the user's authority to operate the equipment.

Flight Restricted Area Illustration

The X-Star and X-Star Premium system automatically recognizes the Flight Restricted Area, in which flights are limited by default. This feature guarantees

pilots' safe and legal operations of the product. The flight restricted areas are divided into 2 protection categories.

Category I: Major airports and flight areas where manned aircrafts operate at low altitudes

- **Take-off Restricted Zones (No-Fly Zones)**

These areas are set within 2.4km around the central point of specified airports.

- **Altitude Restricted Zones**

In these areas, the aircraft is only allowed to fly within limited altitudes. From 8km to 2.4km around the airport's central point, the flight altitude decreases progressively from 120m to 10.5m.

- **Warning Zones**

Once the aircraft enters a region within 8.1 km from the central point of the airport, the app will prompt a warning message.

 **NOTE**

If the aircraft enters any **Altitude Restricted Zones**, its maximum allowable altitude will be reduced accordingly. If the aircraft enters any **Take-off Restricted Zones**, it will land automatically. You should pay special attention to the warning messages displayed on your app.

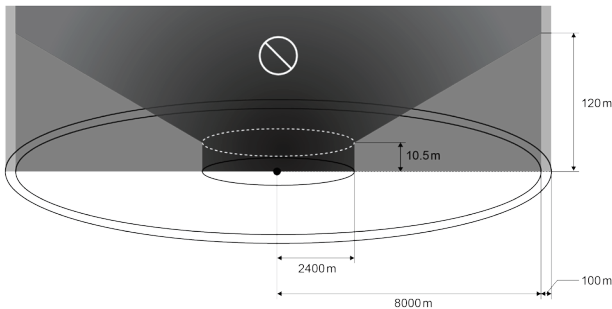

Category II: Sensitive areas and institutes such as military sites and border lines between countries

- **Take-off Restricted Zones (No-Fly Zones)**

These areas are set within 1km around the center of the specified sites where take-off and flight are prohibited.

- **Warning Zone**

Once the aircraft enters the region within 2km from the center of the site, the app will prompt a warning message.

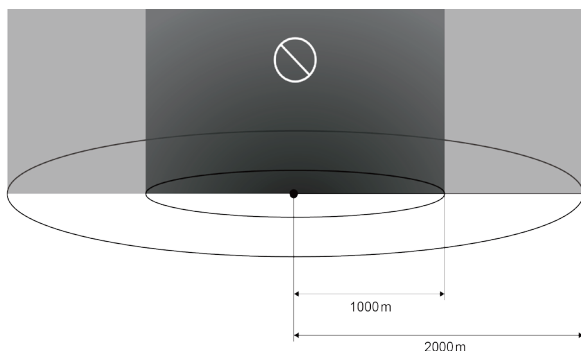

Technical Specifications

Aircraft Specifications	
Hover Precision	Horizontal: ± 2.5 m; Vertical: ± 1 m;
Max Yaw Rate	150°/s
Max Inclination Angle	GPS Mode: 20°; ATTI Mode: 25°
Max Ascent/Descent Speed	Ascent: 6 m/s; Descent: 3 m/s
Max Horizontal Speed	15 m/s
Diagonal Wheelbase	352 mm
Propeller Size	9.4"x5.5"
Video Link Frequency	X-Star: 2.412 GHz~2.462 GHz
	X-Star Premium: 902 MHz~928 MHz
Receiver Frequency	5.745 GHz~5.799 GHz
Flight Modes	GPS, ATTI, IOC
Operating Environment Temperature	-10°C~45°C (14°F~113°F)
Storage Temperature	-20°C~80°C (-4°F~176°F)
Weight (Battery & Propellers included)	1.42 kg

Aircraft Battery Specifications	
Battery Type	Rechargeable Li-Po battery
Capacity	4900 mAh
Battery Voltage	14.8 V
Charging Environment Temperature	10°C~45°C (50°F~113°F)

Discharging Environment Temperature	-10°C~45°C (14°F~113°F)
Storage Temperature & Humidity	Temp: 18°C~28°C (64°F~82.4°F); Humidity: 52~78%

Camera Gimbal Specifications

Operating Current	650 mA@12 V (Non-video Mode) 760 mA@12 V (Video Mode)
Input Voltage	12 V
Operating Temperature	-10°C~50°C
Weight	175g (Camera incl.)
Dimensions (Damping Device excl.)	88 mm X 76.5 mm X 80 mm
Control Accuracy	Pitch: ±0.015°; Roll: ±0.015°; Yaw: ±0.015°
Max. Angular Velocity	Pitch: ±300°/S Yaw: 360°/S
Controllable Range	Pitch: 0°~90°

Camera Specifications

Operating Environment Temperature	0°C~40°C (32°F~104°F)
Still Photography Modes	Single shot Burst: 3/5/7 frames Auto Exposure Bracketing (AEB): 3/5 Bracketed frames at 0.7EV bias Timelapse
Video Recording Modes	UHD: 4096x2160p 24/25, 3840x2160p 24/25/30 QHD: 2704x1520p 24/25/30/48/50/60 FHD: 1920x1080p 24/25/30/48/50/60/120 HD: 1280x720p 24/25/30/48/50/60/240 SUPERVIEW: 1920x1080p 24/25/30/48/50/60
Max. Field of View	108°
Supported SD Card Types	Micro-SD card Storage capacity: 4 GB - 64GB Class level: Class 10 or UHS-1 rating required
File Formats	FAT32/exFAT Photo: RAW/RAW/RAW+RAW Video: MOV/MP4

Remote Controller Specifications

RF Receiver Operating Frequency	5.745 GHz~5.799 GHz	
Video Link Frequency	X-Star	2.412 GHz~2.462 GHz
	X-Star Premium	902 MHz~928 MHz (America)
		915 MHz~928 MHz (Australia)
Operating Temperature	-20°C~60°C (-4°F~140°F)	
Charging Temperature	10°C~45°C (50°F~113°F)	
Storage Temperature	Less than 1 month: -10°C~45°C (14°F~113°F) 1~6 months: -10°C~35°C (14°F~95°F)	
Communication Distance (Open Area)	X-Star	CE: 500 m; FCC: 1000 m
	X-Star Premium	FCC: 2000 m
Operating Current/Voltage	X-Star	750 mA/3.7 V
	X-Star Premium	350 mA/3.7 V (App disconnected)
		1400 mA/3.7 V (App connected)
Battery	6000 mAh rechargeable Li-ion battery	
Power Consumption	X-Star	2.8 W
	X-Star Premium	5.2 W
Weight (battery included)	X-Star	830 g
	X-Star Premium	840 g