

# INSTALLATION INSTRUCTIONS

*Swiss Madison*<sup>®</sup>  
well made forever

## Vivante Smart Toilet Seat Bidet

SM-STS01

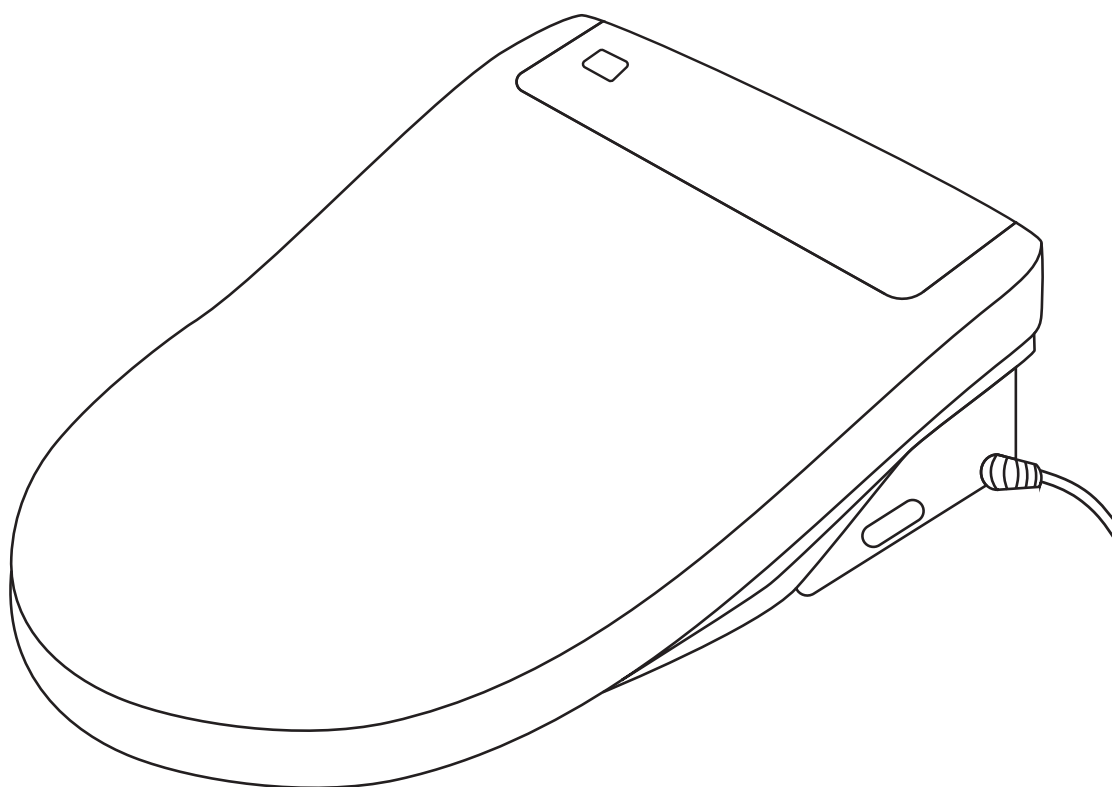

Share your pictures for a feature  
using **#SwissMadison**



# Thank you for your purchase!

Thank you for purchasing a Swiss Madison Smart Toilet Seat Bidet.

We appreciate your business and know you will enjoy your seat for many years to come.

If you have any questions or require assistance we would be happy to help,  
please contact us at 1-434-623-4766 or [info@swissmadison.com](mailto:info@swissmadison.com).

**To learn more about our products, please visit:**

**[www.swissmadison.com](http://www.swissmadison.com)**

Sincerely,

The Swiss Madison Team



## Prior to Installation:

- Inspect toilet seat to ensure no damages have occurred while in shipping.
- Observe all plumbing and building codes in accordance with your state and local requirements.
- Additional preparations may be necessary to avoid damage to the product.

**General Recommendations:** Read installation and maintenance instructions thoroughly before installing the smart seat.  
Be sure to use proper tools and always wear proper personal safety accessories for your protection.

**If you have any questions or concerns please contact us:**

1-434-623-4766  
[info@swissmadison.com](mailto:info@swissmadison.com)

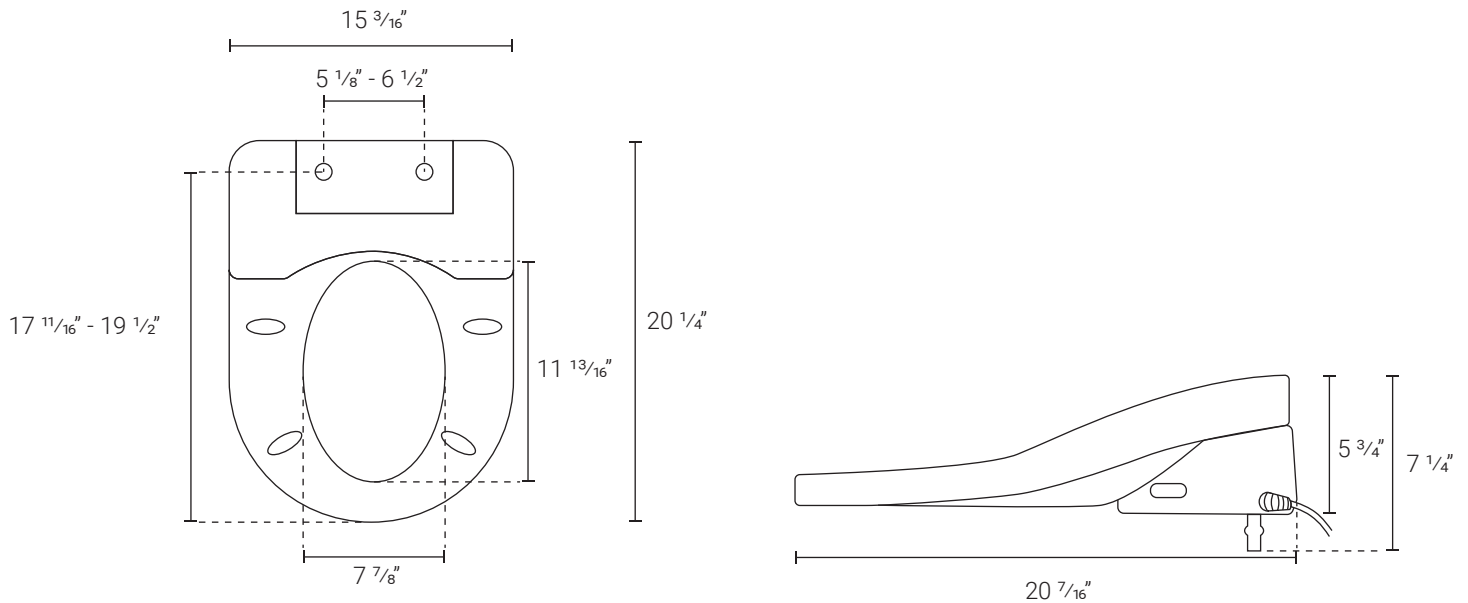

## PARTS LIST

- Swiss Madison Toilet Seat
- Remote Control Panel Parts
- Base Plate Parts
- Water Supply Assembly

The step-by-step guidelines in the installation instructions are a general reference for installing a Swiss Madison Smart Toilet Seat Bidet. Should there be any discrepancies, Swiss Madison cannot be held liable. It is recommended to install all Swiss Madison products by hiring a licensed professional.



1. Read the complete instruction manual before beginning installation.



2. Confirm that your model will fit in intended location and plumbing



fixtures are located where legally required before beginning installation.

When using electrical products, especially when children are present, basic safety precautions should always be followed:

1. The appliance is not to be used by persons (including children) with reduced physical, sensory, mental capabilities, or lack of experience and knowledge, unless they have been given supervision or instruction.
2. Children should be supervised not to play with the appliance.
3. Cleaning and user maintenance shall not be done by children without supervision.

## READ ALL INSTRUCTIONS BEFORE USING

**⚠ DANGER** - To reduce the risk of electrocution:

1. Do not use while bathing.
2. Do not place or store product where it can fall or be pulled into a tub or a sink.
3. Do not place in or drop into water or other liquid.
4. Do not reach for a product that has fallen into water. Unplug immediately.
5. Do not wash the main unit or electrical plug with water or detergent.
6. Do not handle the electrical plug with wet hands.
7. Do not put a hand or other object over the outlet of air dryer or block the outlet of air dryer.
8. Never disassemble, repair or modify this product.
9. During installation, disassembly, repair and maintenance of the product, the power plug must be switched off and water supply be shut off.

**⚠ WARNING** - To reduce the risk of burns, electrocution, fire, or injury:

1. Close supervision is necessary when this product is used by, on, or near children or invalids.
2. Use this product only for its intended use as described in this manual. Do not use attachments not recommended by the manufacturer.
3. Never operate this product if it has a damaged cord or plug, if it is not working properly, if it has been dropped or damaged, or dropped into water. Return the product to a service center for examination and repair.
4. Keep the cord away from heated surfaces.
5. Never use while sleeping or drowsy.
6. Never drop or insert any object into any opening or hose.
7. Do not use outdoors or operate where aerosol (spray) products are being used or where oxygen is being administered.
8. Connect this product to a properly grounded outlet only. See Grounding Instructions.
9. Do not throw cigarettes or other burning stuff into toilet, it may cause a fire.
10. This product is an electric appliance, so it must be placed far away from water.
11. Do not lay the product on side or upside-down during the electrical circuit.
12. It is prohibited to use other electric appliances in the same socket.
13. It is forbidden to use the power extension or unstable loose outlet.
14. An old aging water supply hose cannot be used, otherwise it might cause leakage, fire or electrical shock. Installation of the seat should include specified components and new water supply hose.

⚠ **CAUTION** - Failure to follow the instructions may cause body injury or property damage.

1. Do not install or use the product in wet places such as a steam room etc.
2. It is recommended to use a water-proof electrical outlet which should be installed in a place where it cannot easily get wet.
3. This product should be used with 110V-120V, 50/60Hz electrical current only, load current is at least 15A. Power plug must be equipped with ground fault circuit interrupter or ground fault electrical leakage protector or similar high sensitive, rapid type leakage switch (rated sensitive current under 6mA).
4. When it thunders, it is strongly recommended to pull out the power plug.
5. Do not stand on ceramic toilet.
6. Ceramic toilet must be installed by a floor fixing bolt.
7. Do not stand on product unit, seat or cover.
8. Do not lean against the seat cover when using the product to avoid damage.
9. This product is equipped with soft-closing seal cover. Heavy pressing or pushing may cause damage to the soft-closing damper.
10. Do not use lacquer thinner, petrol, liquid medicine, detergent, insecticide, toilet cleanser and scrubbing brush to clean the product.
11. Exposure to direct sunlight is prohibited.
12. Only use tap water or potable water; otherwise it may cause chafing.
13. Do not connect water supply to heater outlet. Make sure inlet water temperature at 37-95°F.
14. When the room temperature is under zero degrees, please dry up the water tank to avoid freezing.
15. Raise restroom temperature to prevent the toilet from damage due to freezing.
16. When moving the product from cold to room-temperature wait two hours for water to evaporate. Doing so can prevent the product from electrical short-circuit.
17. When product is not used for three days, drain the water out of the container and pull the electrical plug from the wall outlet.
18. Stop using the product and shut off the power when product malfunctions. Please contact a licensed professional.

## GROUNDING INSTRUCTIONS



This product should be grounded. In the event of an electrical short circuit, grounding reduces the risk of electric shock by providing an escape wire for the electric current. This product is equipped with a cord having a grounding wire with a grounding plug. The plug must be plugged into an outlet that is properly installed and grounded.

⚠ **DANGER** - Improper use of the grounding plug can result in a risk of electric shock.

If repair or replacement of the cord or plug is necessary, do not connect the grounding wire to either flat blade terminal. The green wire (with or without a yellow stripe) is the grounding wire.

This product is factory equipped with a specific electric cord and plug to permit connection to a proper electric circuit. Make sure that the product is connected to an outlet having the same configuration as the plug. No adapter should be used with this product. Do not modify the plug provided - if it will not fit the outlet, have the proper outlet installed by a qualified electrician. If the product must be reconnected for use on a different type of electric circuit, the reconnection should be made by qualified service personnel.

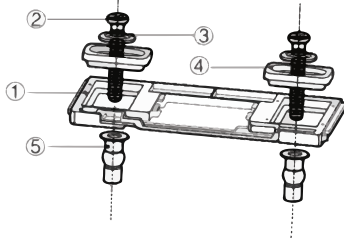
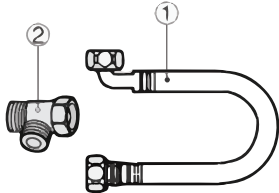
<b>Main Unit</b>	Rating pressure	110-120V, 50/60Hz
	Rating power	1050-1250W
	Water pressure range	Minimum water pressure 0.07MPa (20L/min. flowing pressure) Maximum water pressure 0.8MPa (Hydrostatic pressure)
	Electrical wire	Length is about 1.8 m
<b>Cleaning Device</b>	Container capacity	600 mL
	Heating power	1000 W
	Water temperature	6 different level adjustments
	Water volume	5 different level adjustments
	Cleansing mode	Rear cleaning / rear massage, front cleaning for ladies
	Spray cleansing location	5 different level adjustment
	Water pressure protector	Pressure stabilize, automatic pressure discharging
	Anti-fouling device	Speedy water discharge device, automatic nozzle cleaning, Anti-siphon device, anti-back flow device, filter device
	Safety device	Temperature controller, thermal fuse, ground protection, leakage protection device, air burning preventer
<b>Drying Device</b>	Warm wind speed	Over 9 mph
	Warm wind temperature	6 different level adjustments
	Heating power	50 W
	Safety device	Temperature sensor, temperature controller, thermal fuse
<b>Heated Seat</b>	Surface temperature	6 different level adjustments
	Heating power	50 W
	Open and close device	Quiet soft-closing device
	Heated burning protection	The seat temperature will automatically lower to level 1 to 10 minutes after using
	Safety device	Seat sensor, temperature sensor, temperature controller, thermal fuse
<b>Intelligent</b>	Night light assembly	Intelligent, often in the off state
	Mute setting	Buzzer off during night
	User ID setting	To avoid disturbance from remote controls by multi-user

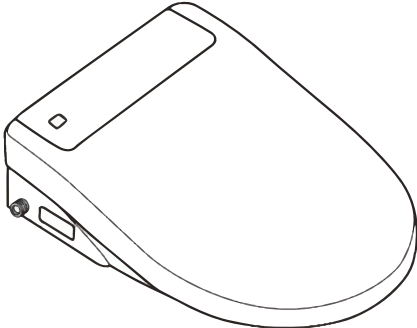
<p><b>Remote Control Panel Parts</b></p>	<p>The appearance and function of the remote control are subject to the actual product</p>	
<p><b>Base Plate Parts</b></p>	<p>1. Base plate 2. Bolt (2 pcs.) 3. Flat washer (2pcs.) 4. Plastic plate (2pcs.) 5. Expansion nut (2 pcs.)</p>	
<p><b>Water Supply Assembly</b></p>	<p>1. Water supply pipe (1 pcs.) 2. 3-way connector (1pcs.)</p>	
<p><b>Installation Manual</b></p>	<p>Installation manual</p>	
<p><b>Warranty Card</b></p>	<p>Warranty card</p>	
<p><b>Installation Paperboard</b></p>	<p>Installation paperboard</p>	
<p><b>Main Unit</b></p>		

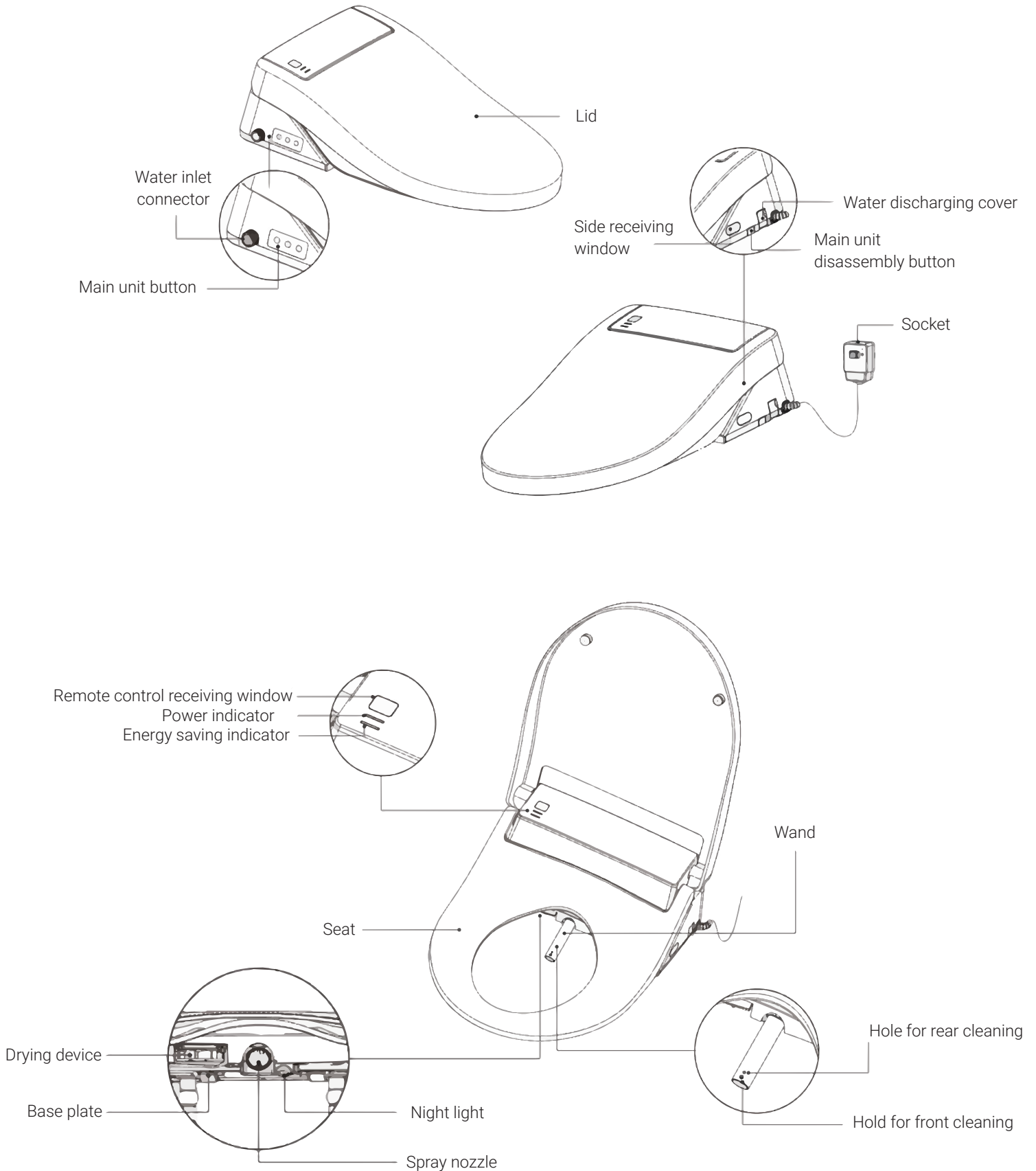



## Installation Dimensions

NOTE: Please check if the installation dimensions match the user's toilet.

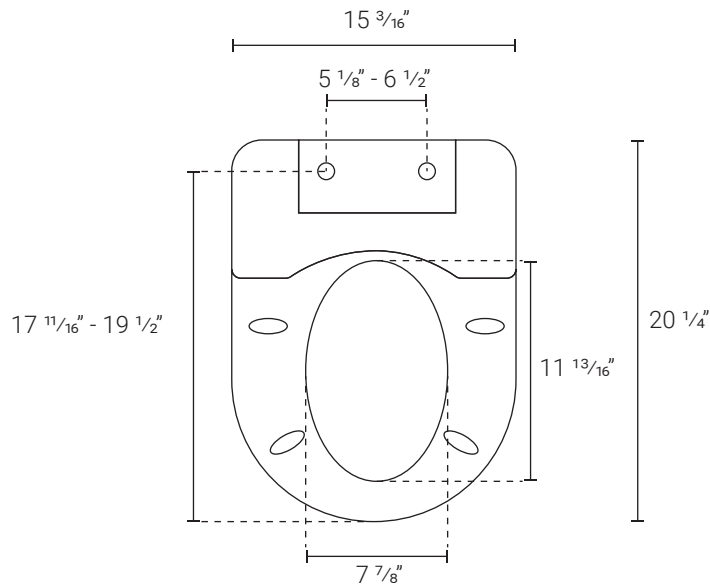

## Installation of Mounting Plate

Press the expansion nuts into the installation holes in the toilet, then install the base plate, plastic plates, flat washers and bolts as per the drawing and tighten the bolts.

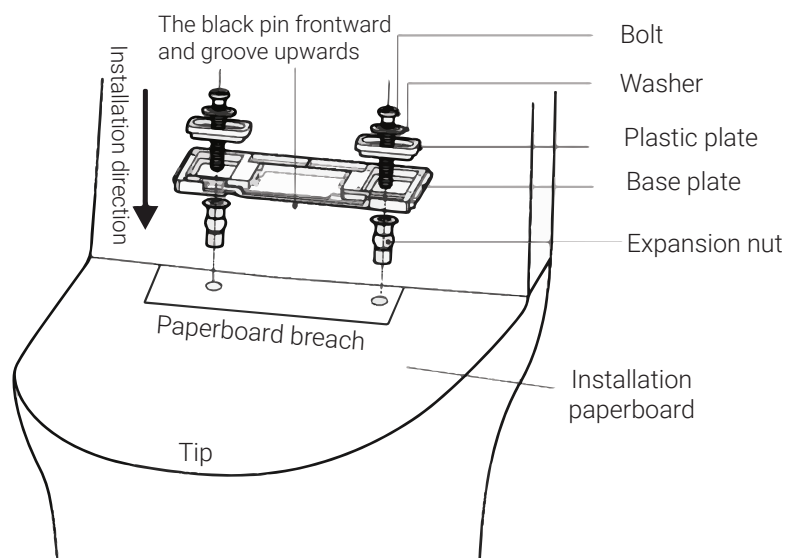

NOTE: Unfold the installation paperboard, align the paperboard to fit the ceramic bowl from the tip, then insert the base plate to the paperboard breach to make sure the base plate aligns with the paperboard breach.

## Installation and Disassembly of Main Unit

Installation:  
Push the washlet back onto the base plate until a "click" is heard.

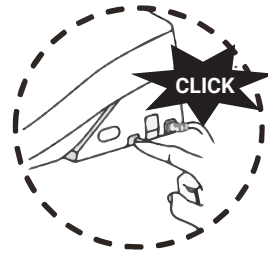
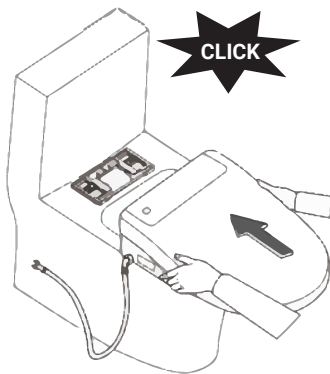

Disassembly:  
Press the "removal button" on washlet, until a "click" is heard, and pull it out.

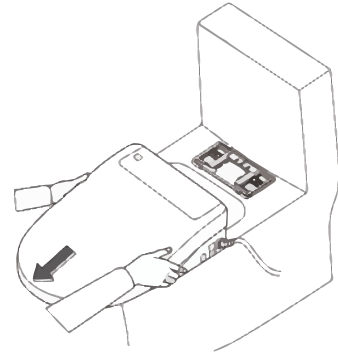

NOTE : Before pulling out the washlet, release hand from "removal button".

## Connecting the Water Supply Pipe

1. Side inlet: Install the 3-way valve onto angle valve, then attach the water supply hose and the washlet inlet hose into 3-way valve. Connect L-shaped end of water supply hose to the washlet inlet connector.
2. Bottom inlet: Connect water supply on the inlet connector, then put supply hose and power line through the relevant holes, finally install seat cover.

NOTE: Do not overtighten or cross the threads when connecting supply line to seat fitting. It is recommended to use plumber's tape on all threaded connections to avoid leakage.

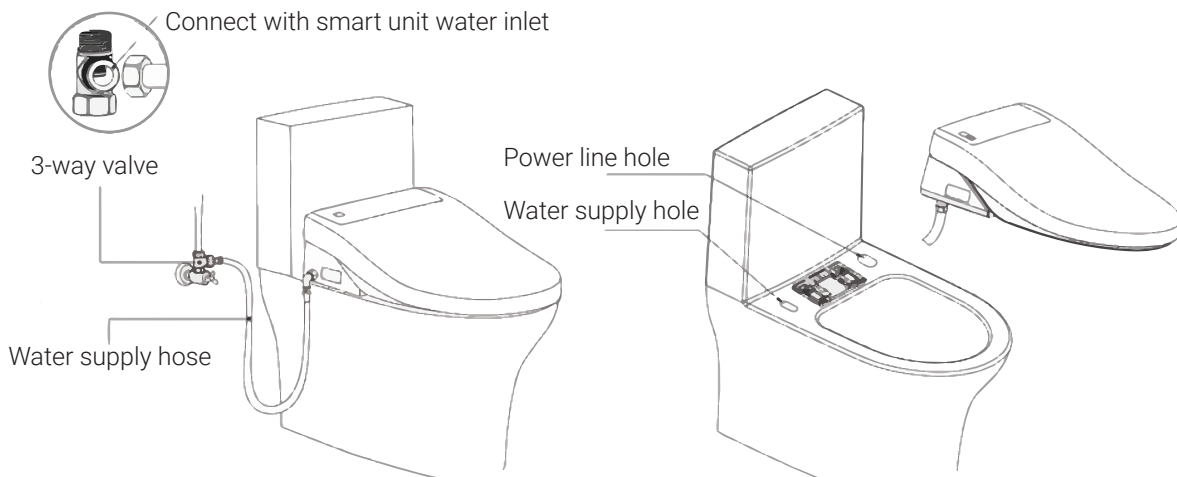

NOTE: Do not distort or damage the supply hose to avoid any leakage.  
Do not use water supply hose and other accessories of other brands, which may cause danger.  
Do not recommend to use old water supply hose and accessories, which may cause danger.

## Checking the Power and Water Supply

Connect the water supply hose and turn on the angle valve. Check for any leakage.

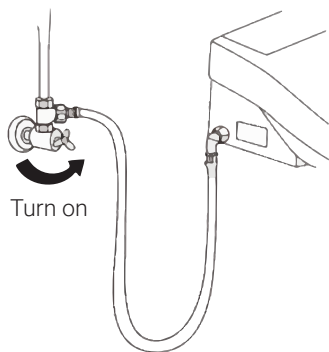

Insert power plug into power socket.

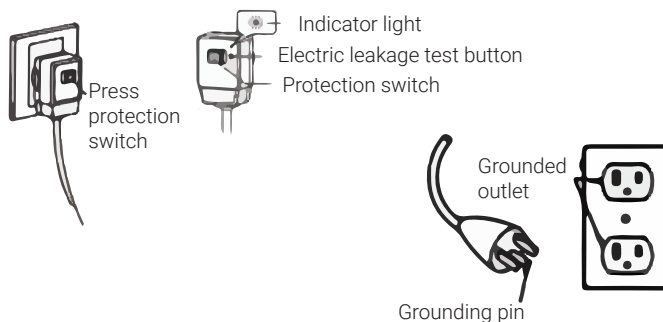

The main unit buzzer first “clicks”, the power light and energy saver light will flash. Power light on and energy saver light off means self-inspection.

The buzzer second “clicks” to show that self inspection is finished.

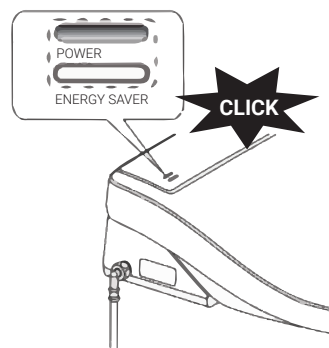
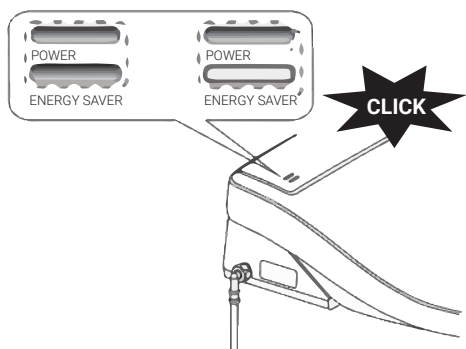



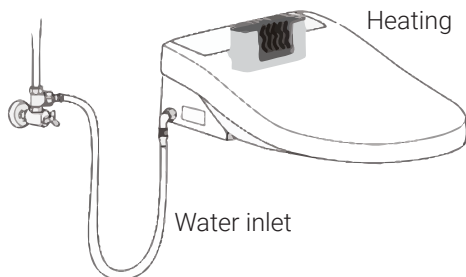

The water starts to flow into tank and heating will take 3 minutes.



Wait for 3 minutes



**Function Illustration of Keys in Main Unit and Actuator**

	 Power	<ol style="list-style-type: none"> <li>1. Long press “Power” button to enter standby mode and then quick press “Power” button to restore functional mode.</li> <li>2. When people sit, press “Power” button to stop the function of rear, front cleaning or drying. When no one sits, press “Power” button to switch between function mode and power save mode.</li> </ol>
	 Front cleaning button	When people sit, press “Front cleaning” button, it will clean the front portion of body; repress “Front cleaning” button or “Power” button, the function will be finished. After a cycle, this function will be finished automatically, if people keep sit, it will switch to drying function, and will stop after a cycle.
	 Rear cleaning button	<ol style="list-style-type: none"> <li>1. When people sit, press “Rear cleaning” button, it will clean the rear portion of body; repress “Front cleaning” button or “Power” button, the function will be finished. After a cycle, this function will be finished automatically. If people keep sitting, it will switch to a drying function and will stop after a cycle.</li> <li>2. When no one sits, press “Rear cleaning” button, then the wand will stretch out to clean the nozzle and spray wand.</li> </ol>

Remark:

1. When main unit is in functional mode, the power light goes on and energy saver light goes off; When in energy saving mode, the power light goes off, and the energy saver light goes on; When in standby mode, both lights are off.
2. The default setting of all function is on middle level, after using remote-controller, shift to the level showing on remote-controller.
3. If the product is not used for continual 72 hours, the water in the tank will automatically discharge for 90 seconds and be replaced by fresh water to avoid bacteria.

**Function Illustration of Keys in Remote-Control and LCD Display Instruction**

The operating method of remote control is explained in instruction manual.

**Main Unit Maintenance**

1. Shut off power supply before maintenance.
2. Open the seat, press down the button located on the right side of the main unit and pull out the seat. Wipe with a soft damp cloth.
3. After cleaning, re-install the seat back to the main unit.



NOTE: Do not pour water on the product during maintenance.

**Spray Nozzle Maintenance**

Do the following to clean the wand:

1. Press “nozzle cleaning” or “rear cleaning” button for a while and the wand will come out. Wipe the wand clean with a soft, damp cloth.
2. Hold “nozzle cleaning” button and the wand doesn’t come out. The nozzle will automatically spray to self-clean.
3. Press again “nozzle cleaning” or “stop cleaning” or “rear cleaning” button, it will stop the cleaning.

(the button function will be different according to different optional remote control)

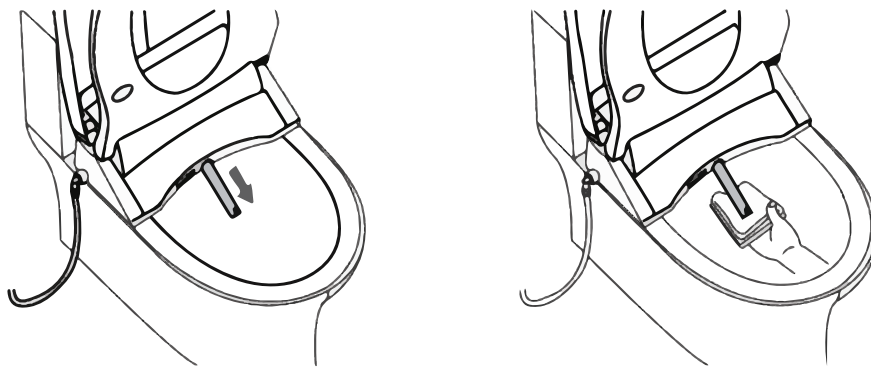

NOTE: Do not apply force when pushing or pulling the wand, as this may damage the mechanism.

## Inlet Filter Cleaning

1. Pull out electrical plug, then shut off water supply valve and remove water supply hose.
2. Remove the filter. Use the brush to clean the filter.
3. Put the filter back into inlet after cleaning. Then connect the water supply pipe.

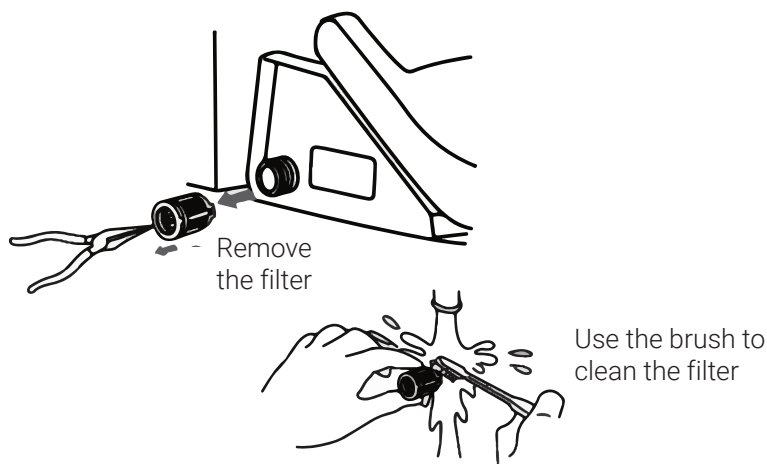

## Tank Anti-Freezing and Anti-Bacterial Maintenance

NOTE: When room temperature is under zero and electricity is disconnected, or user is away for a long time, the water inside the tank should be discharged.

1. Open the tank cover, press the discharge button, turn on the valve to discharge the water.
2. Slightly press the discharge button protruding part to turn off discharging valve and cover.

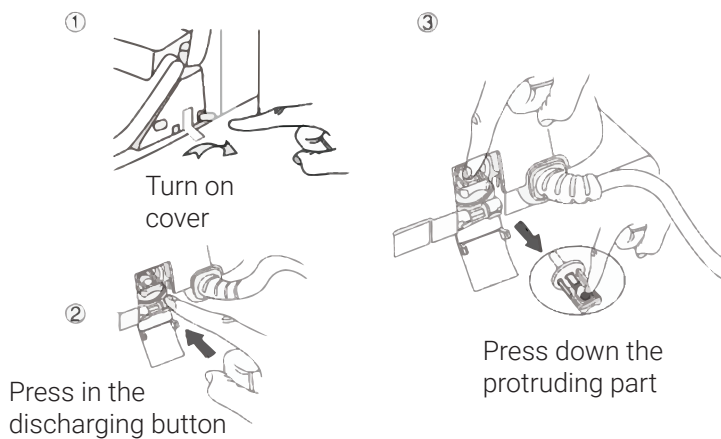

**⚠ WARNING:** Before water starts discharging, the power must be turned off!

Problem	Cause	Solution
<b>No flushing</b>	Water supply hose buckling causes block	Solve the buckling
	Fill valve is off	Turn on the fill valve
	Water supply is cut off	Connect water supply and wait for the water
<b>Poor flushing</b>	Water supply hose buckling causes partial block	Solve the buckling
	Fill valve is not fully turned on	Turn on the fill valve fully
	Filter is dirty and causes block	Clean the filter
<b>The water is not hot</b>	The water temperature is set on normal temperature level	Reset the water temperature
	In standby mode or power save mode	Switch to function mode, then wash after 3 minutes
<b>Seat temperature is not hot</b>	Seat temperature is set on normal temperature level	Reset the seat temperature
	In standby mode	Shift to function mode for 3 minutes
<b>Wind temperature is not hot</b>	Wind temperature is set on normal temperature mode	Reset the wind temperature
<b>No wind out</b>	In standby mode or power saver mode	Shift to function mode to use dry function
<b>Spray wand not retracting</b>	Power off	Push back the wand lightly and wait for the power
	Gets stuck by impurities	Clear away impurities
<b>Spray wand not stretching out</b>	Power off	Push back the wand lightly and wait
	Not sitting in sensing area	Sit right in the sensing area
<b>Controller cannot display</b>	Reverse the polarity of battery	Reload the battery
 <b>CAUTION</b>	If the problems cannot be solved as per above methods, please shut off the power, and contact service providers for maintenance.	
	If the leakage circuit breaker often trips off, it means the product has electricity leakage, so please shut off the power, and contact service provider for maintenance.	

 **WARNING:** This product can expose you to chemicals including arsenic, which is known to the State of California to cause cancer. For more information, go to [www.P65Warnings.ca.gov](http://www.P65Warnings.ca.gov).

## **ONE YEAR LIMITED WARRANTY**

Swiss Madison® products are made with quality materials and excellent craftsmanship to provide our customers with beautiful, durable, long-lasting products. Should there be any defects in materials or craftsmanship under regular use that are discovered within the first year of installation, Swiss Madison® will provide replacement parts at no charge, or at its discretion, replace any product or part of the product that is deemed defective, under normal installation, use, service or maintenance. This warranty applies only to the original purchaser. Proof of purchase will be required in the instance of a claim.

Swiss Madison® recommends all installations of Swiss Madison® products to be conducted by a licensed, professional plumber or contractor. Swiss Madison® will not be held responsible for any damage or product failure due to improper installation, misuse, or failure to utilize a licensed professional for installation. Swiss Madison® is not responsible for any installation or removal costs.

### **This One Year Limited Warranty Will Be Voided If:**

- The installation recommendations were not followed by the installer
- The product has been moved from its initial place of installation
- The product has in any way been modified from its packaged state
- The product has been subjected to improper maintenance, abuse, misuse, excessive use of chemicals, accidents, or other damages, etc.

Swiss Madison® makes no implication that its products comply with any local building or plumbing codes. It is the consumer's responsibility and obligation to determine local code compliance prior to and during installation. This warranty extends only to the original purchaser and first consumer.

Swiss Madison® is not responsible for any special, incidental or consequential damages associated with the installation, replacement, return or use of the original purchaser's product. This includes, but is not limited to: freight costs, labor, travel time, lost profit, home damages and other contingent liabilities and costs (including, without limitation, costs associated with 'professionals' or 'experts', investigations, audits, analyses, attorneys and any other professional/hired services).

The Swiss Madison® warranty is a comprehensive and explicit limit of liability. All items not disclosed within the warranty are not addressable within the responsibility of Swiss Madison®. Certain states have variances regarding implied warranties; in those situations, we remain fully compliant.

**If you have any questions or concerns, please contact us directly at  
1-434-MADISON (623-4766)**

 **WARNING:** Contents of your order may contain sharp and possibly other harmful pieces and may cause hazard to children and adults. Swiss Madison® is not responsible in any way for personal damages.