

REMOTE CONTROL INSTRUCTIONS

Swiss Madison
well made forever

Vivante Smart Toilet Seat Remote SM-STS01

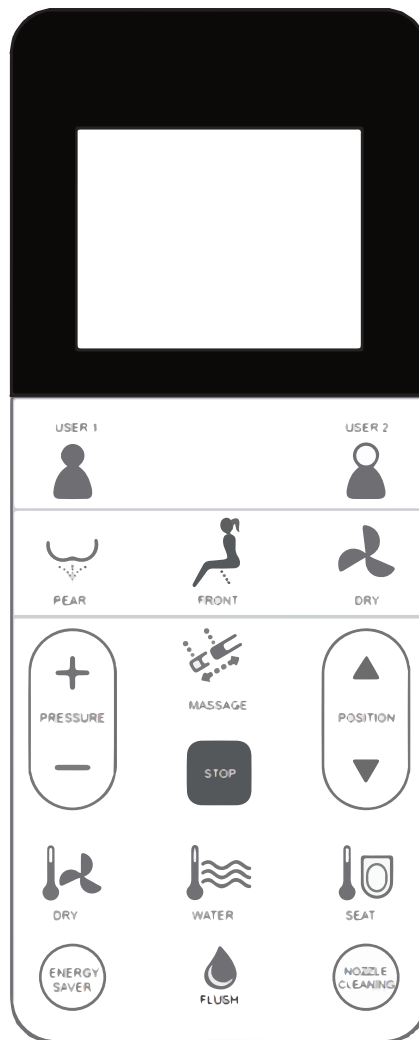

Share your pictures for a feature
using [#SwissMadison](#)



Thank you for your purchase!

If you have any questions or require assistance we would be happy to help,
please contact us at 1-434-623-4766 or info@swissmadison.com.

To learn more about our products, please visit:
www.swissmadison.com

Sincerely,
The Swiss Madison Team



Prior to Installation:

- Inspect toilet seat to ensure no damages have occurred while in shipping.
- Observe all plumbing and building codes in accordance with your state and local requirements.
- Additional preparations may be necessary to avoid damage to the product.

General Recommendations: Read installation and maintenance instructions thoroughly before installing the smart seat.
Be sure to use proper tools and always wear proper personal safety accessories for your protection.

If you have any questions or concerns please contact us:

1-434-623-4766
info@swissmadison.com

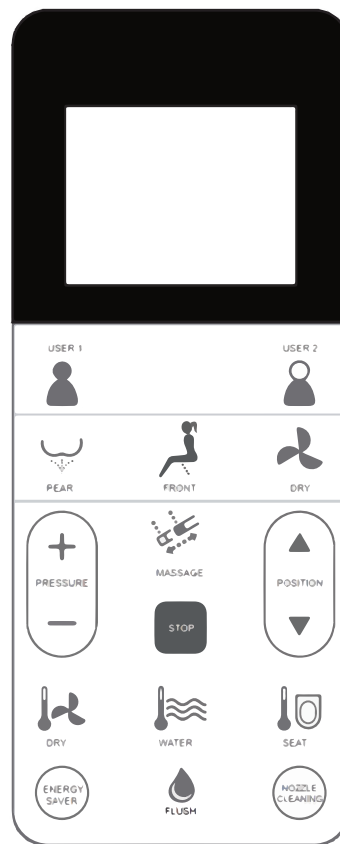

The step-by-step guidelines in the installation instructions are a general reference.
Should there be any discrepancies, Swiss Madison cannot be held liable.
It is recommended to install all Swiss Madison products by hiring a licensed professional.

-  1. Read the complete instruction manual before beginning installation.

Installation Preparation

- 1. Remote control installation 04

Usage Instruction

- 1. Remote control illustration 05
- 2. Rear/Front cleaning operation 06
- 3. Dry operation 06
- 4. Massage operation 07
- 5. Spray nozzle position adjustment 07
- 6. Water pressure adjustment 07
- 7. Energy saver 08
- 8. Full flush 09
- 9. Nozzle cleaning 09
- 10. Automatic deodorization 09
- 11. Temperature adjustment 10
- 12. User code 11
- 13. Open/close by remote controller 11
- 14. Auto function 12
- 15. Combination button 13

Automatic Function Setting

- 1. Setting rear cleaning 14
- 2. Setting front cleaning 15
- 3. Setting rear/front cleaning 16

1. Drill a 6 mm diameter hole on the wall with a depth of 35 mm. Make sure the placement is reachable from the toilet seat.

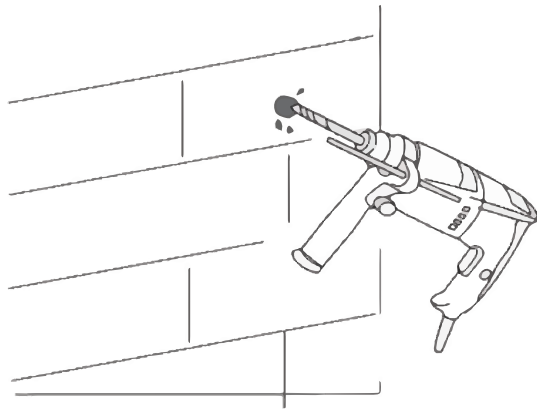

2. Remove the adhesive's protective film on the back of the hanger.

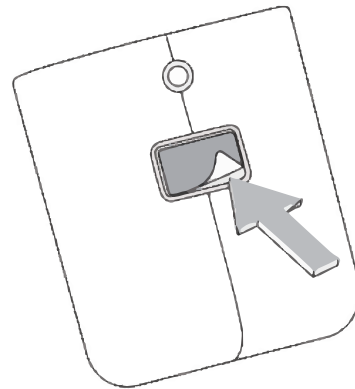

3. Insert wall anchor into the hole in the wall. Install the hanger to the wall with a screw and stick the double-faced adhesive tape to the wall and tighten the screw.

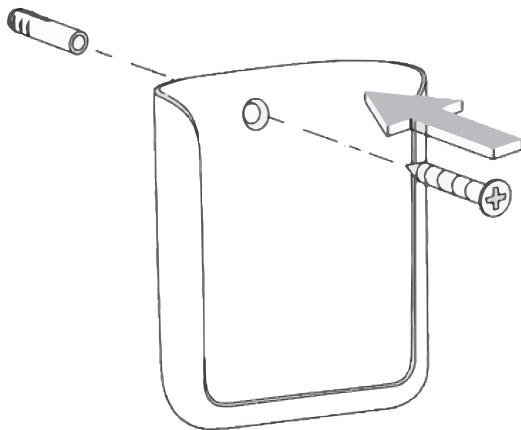

4. Install the battery and place the remote control in the hanger.

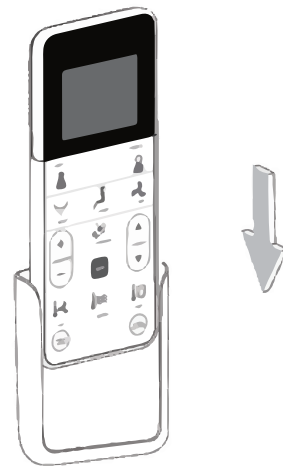

NOTE: Please do not install and use the product in moist places such as a steam room, or in a place where it can easily get wet.

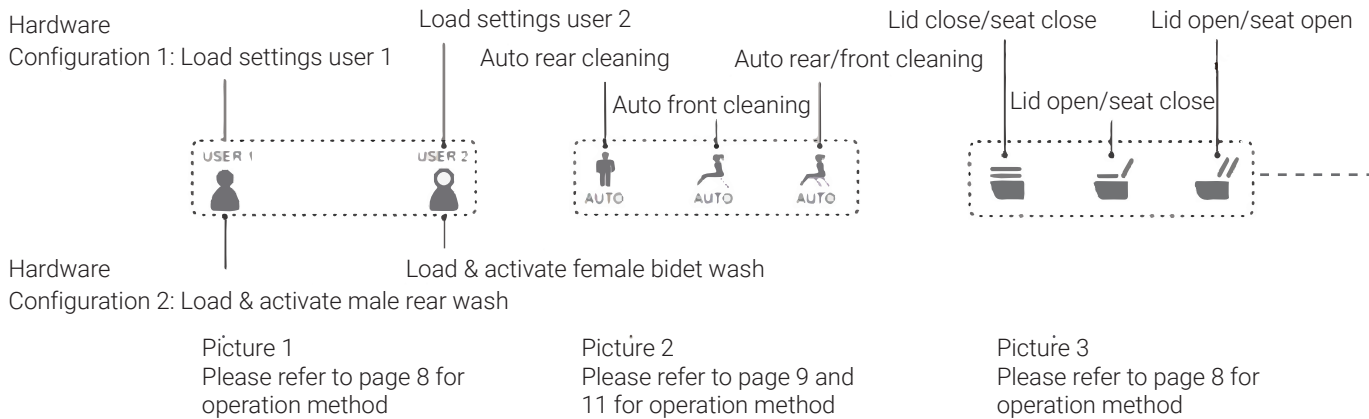
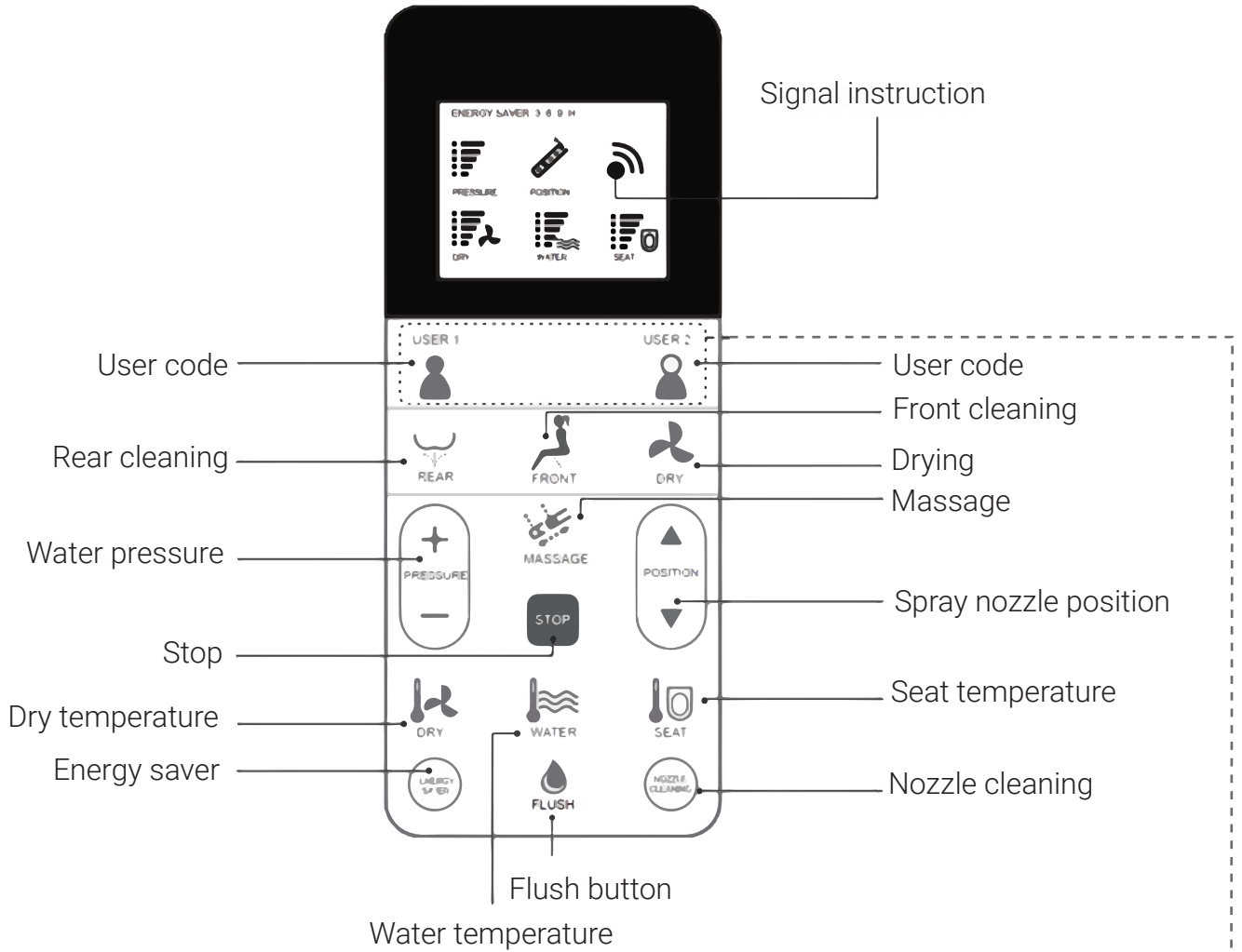

Rear/Front Cleaning

Press "REAR/FRONT" button, the water comes out of the wand to clean the rear/front portion of body. It will automatically stop after a cycle of cleaning. Pressing "STOP" will stop the function immediately.

Drying Operation

Press "DRY" button, warm wind comes out of the wand to dry. After a cycle, or if the user leaves the seat, it automatically stops.

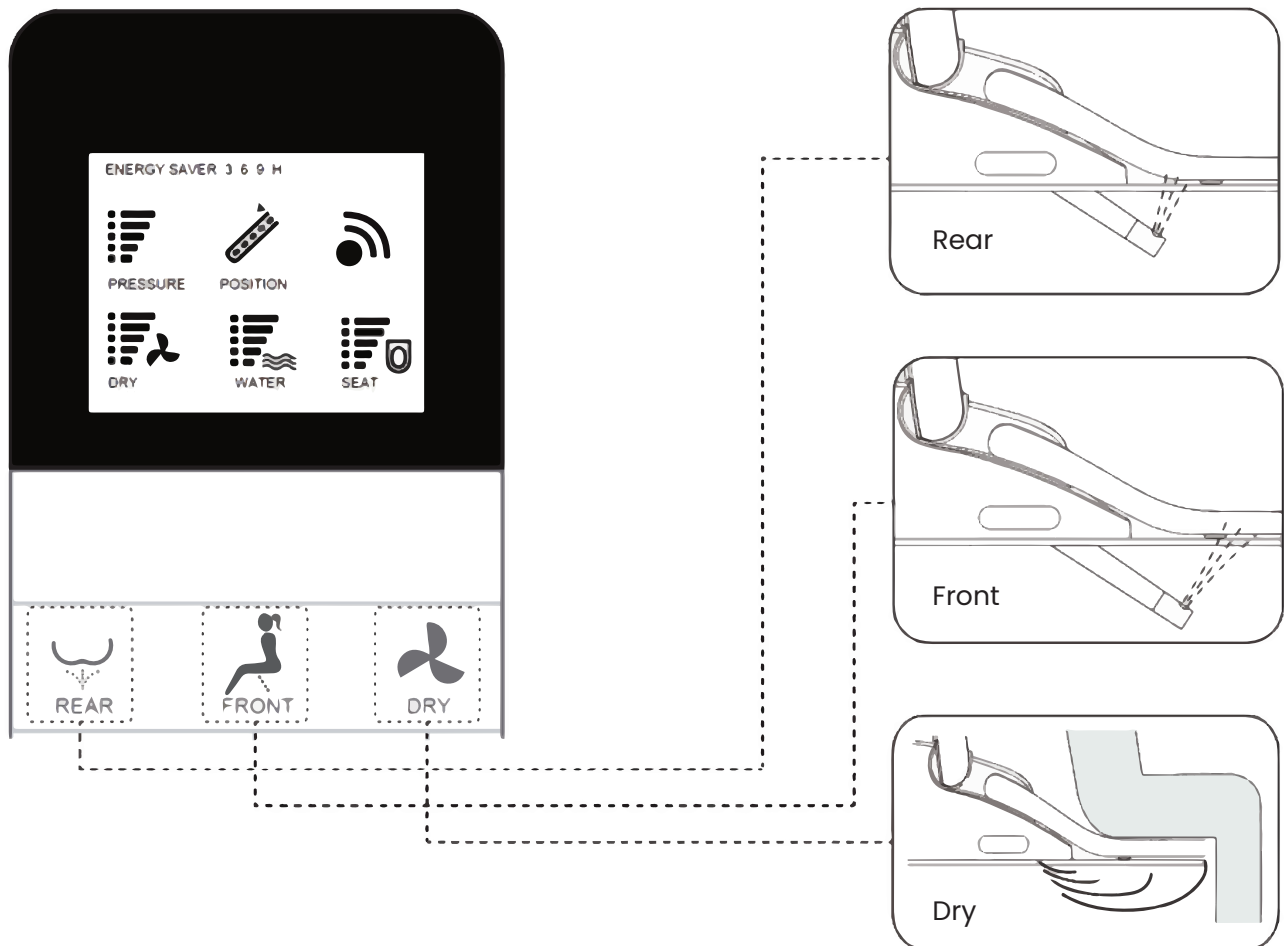

Massage

Press "MASSAGE" button to activate massage function, the nozzle moves forward and back to extend the cleaning scope; Press "MASSAGE" button again to stop the function.

Spray Nozzle Position Adjustment

During "REAR" or "FRONT", press spray nozzle button of "▶" and "◀", to move the position forward and backward by adjusting 5 levels.

Water Pressure Adjustment

During "REAR" or "FRONT", press water pressure button of "+" and "-", to adjust pressure for rear and front cleaning.

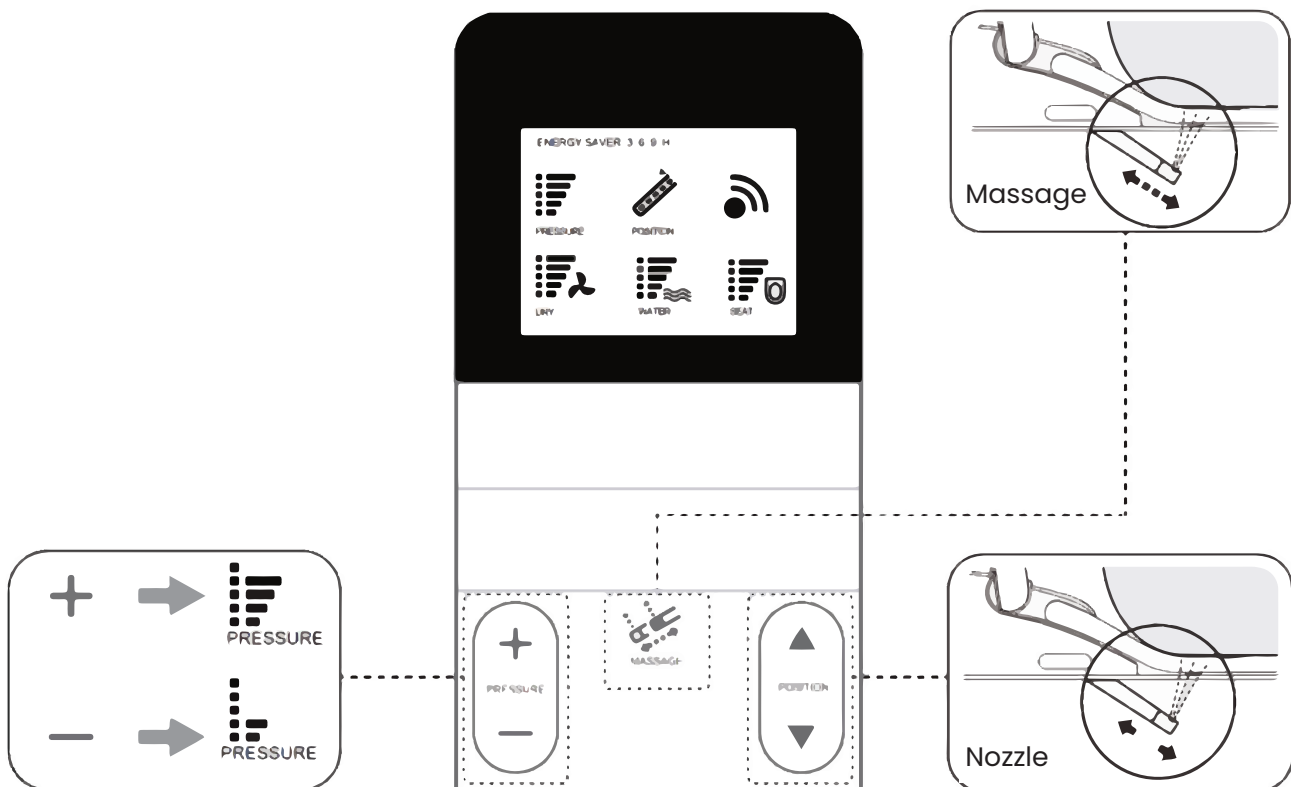

Energy Saver

Press "ENERGY SAVER" button, LCD screen shows energy saver and figures. It shows three options of energy saver period as 3-6-9-off, which can be selected accordingly. For example, user can set from 9:00 to 15:00 as energy saver according to following operation.

1. Press "ENERGY SAVER" button, LCD screen shows "ENERGY SAVER" icon.

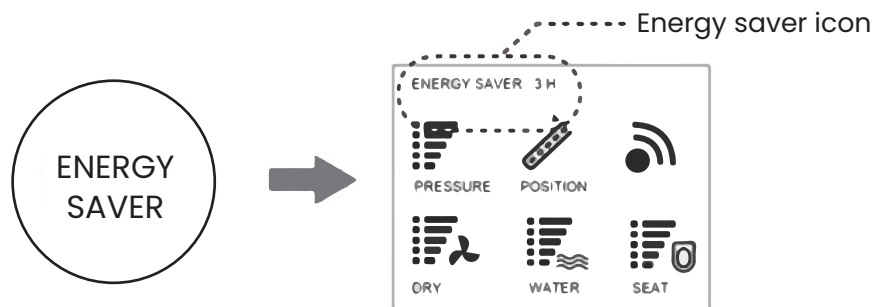

2. Press "ENERGY SAVER" button again, LCD screen shows figure 6, and the "ENERGY SAVER" icon will disappear after 3 seconds. The toilet enters the energy saver mode from 9:00 to 15:00 every day. During this period, the power light is off, and the energy saver light is on. It goes back to normal operation mode after the energy saver time.

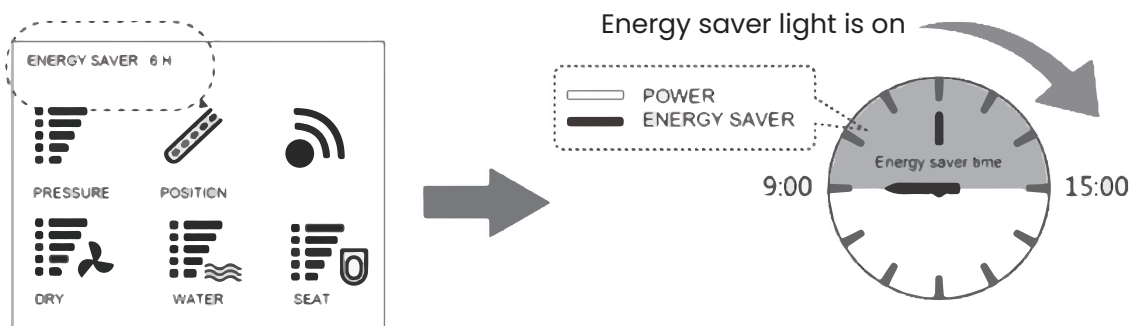

3. Cancel energy saver set "ENERGY SAVER" button continuously until this function is cancelled. (Nothing will display on the screen).

Energy saver: the toilet will be under energy saver mode automatically after setting. Under energy saver mode, seat temperature is on low temperature status (first level) to achieve energy saver.

NOTICE: If user sits on the seat, the energy saver mode is paused and enters into the function mode, the seat starts to heat immediately (under opening seat temperature circumstance). The energy saver mode restores after user leaves. When the energy saver mode is set, the icon disappears automatically, which is normal set.

Full Flush (only for toilets with auto flush function)

Press "FLUSH" button to activate full flushing.

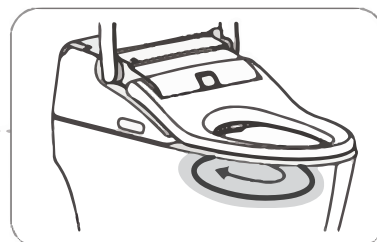

Nozzle Cleaning

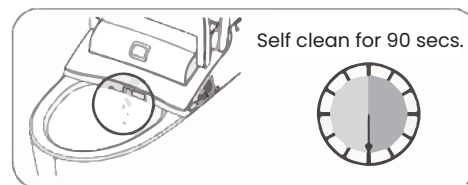
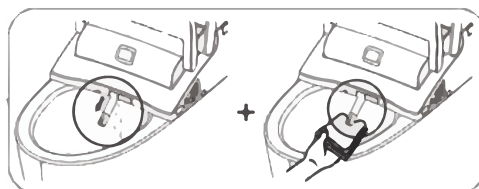

Nozzle Self-Cleaning by Quick Press:

The deodorization function starts to work automatically as the user sits on the seat and stops automatically 3 seconds after the user leaves the seat. When drying, the function of automatic deodorization stops.

Nozzle Self-Cleaning by Long Press:

Long press "NOZZLE CLEANING" button, the spray won't move forward and nozzle self cleans for 90 seconds.

Automatic Deodorization (only for the toilet with auto deodorization function)

The deodorization function starts to work automatically as the user sits on the seat and stops automatically 3 seconds after the user leaves the seat. When drying, the function of automatic deodorization stops.

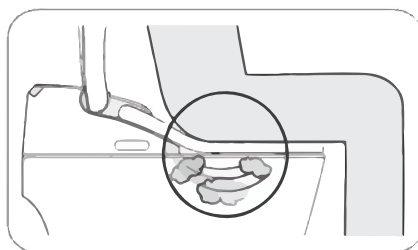

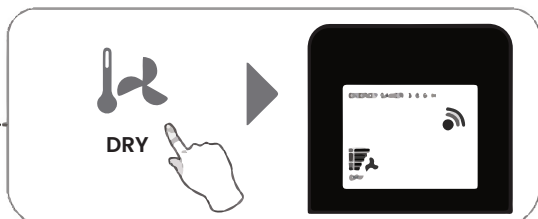

Dry Temperature Adjustment:

Press “DRY” button to adjust temperature for drying. The LCD display of 1 to 5 lines means level 1 to 5. No display means normal temperature. Adjust level by up and down buttons.

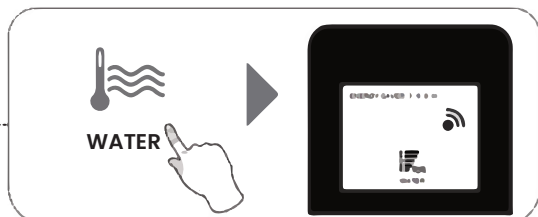

Water Temperature Adjustment:

Press “WATER” button to adjust temperature for rear and front cleaning. The LCD display of 1 to 5 lines means level 1 to 5. No display means normal temperature. Adjust level by up and down buttons.

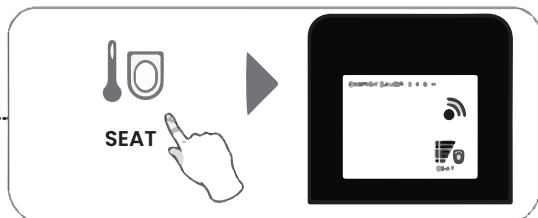

Seat Temperature Adjustment:

Press “SEAT” button to adjust temperature of the seat. The LCD display of 1 to 5 lines means level 1 to 5. No display means normal temperature. Adjust level by up and down buttons.

User Code (only for toilets with User Code function)

Long press "USER 1" or "USER 2" button to save the parameters including current pressure, nozzle position, dry temperature, water temperature, seat temperature and massage status. Quick press "USER 1" or "USER 2" button to use saved parameters.

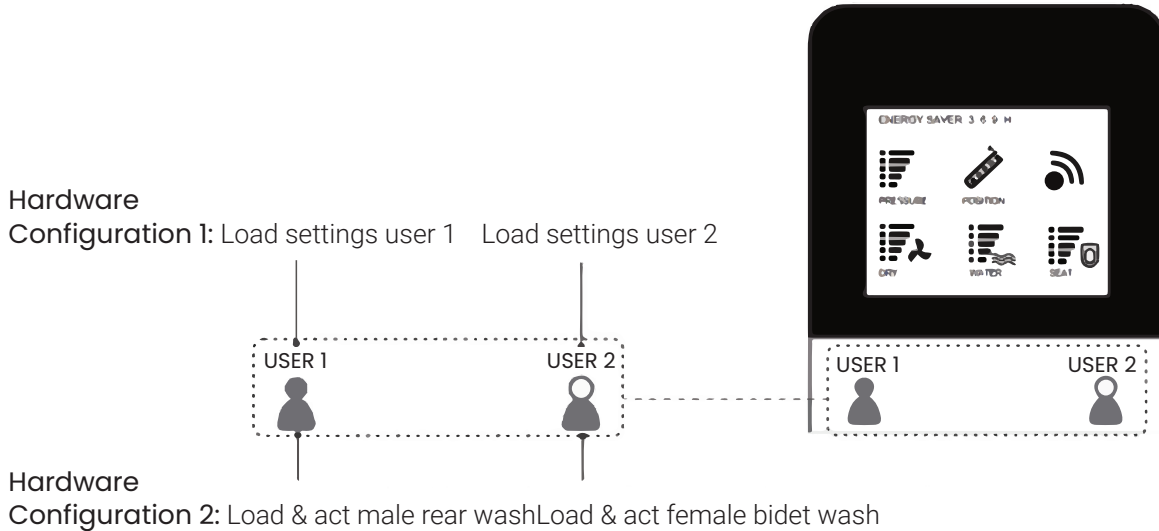

Hardware 1 supports loading user settings only; hardware 2 supports loading & acting user settings simultaneously. Hardware 1 & 2 are matched with different smart seat/cover respectively. They do not coexist. Hardware 1 supports V8100 series, and hardware 2 supports all except V8100 series. Configuration refers to factual product version and subject to change.

Auto Lid Open/Close (only for toilets with this function)

Press "  " button to close seat cover.

Press "  " button to open lid and close seat.

Press "  " button to open lid and seat.

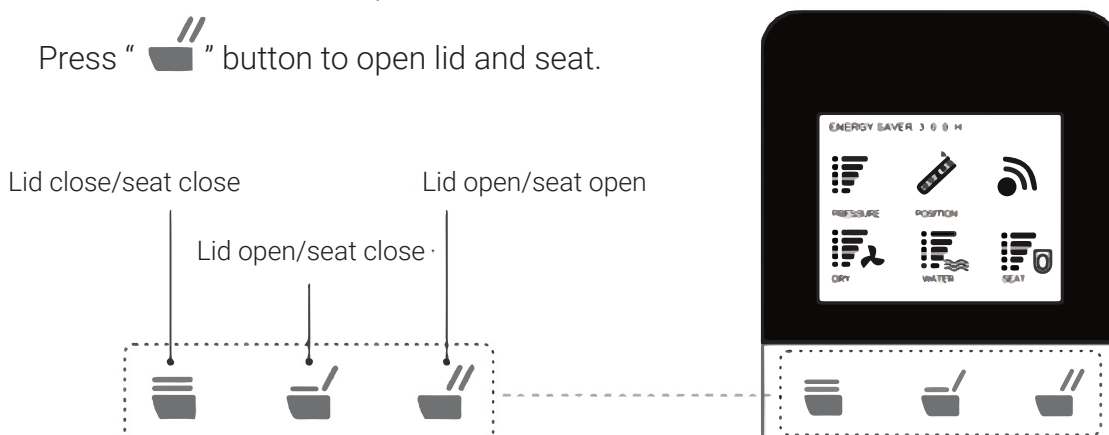

Auto Function (only for toilets with Auto Flush function)

Full-automatic function can be achieved by three "AUTO" buttons, convenient and practical. User can pre-set the suitable nozzle position, water pressure and temperature and save the setting. Full-automatic function will be activated by pressing the related function button when using afterwards.

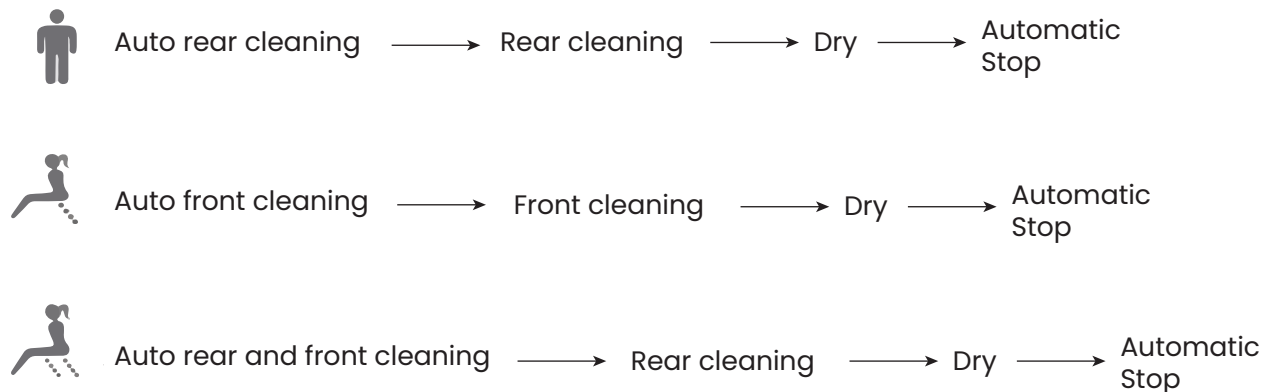

Combination Button

Night Light

Press "STOP" button, then "DRY" button, night light will be in the off state; Repeat the process, night light will switch to non-intelligent state. Repeat above process constantly, the night light will switch between off state and intelligent state.

Quiet Mode

Press "STOP" button and then "MASSAGE" button to turn off buzzer to avoid noise in the night; Repeat the process to start buzzer function.

User Code

The user code needs to be set to avoid disturbances from other remote controls from other toilets being used in the house. Turn on the toilet for setting while turning off others.

1. Press "STOP" button and then "REAR" button to enter into user code setting. The remote control will only show water pressure and spray position level, all other characters will blink on the screen.
2. Press water pressure buttons of "+" and "-", to choose user code 1-9.
3. Press "STOP" button and then "REAR" button again, remote control will save the setting and exit user code setting window, the buzzer will "click" to indicate successful setting.

The sum of water pressure and position level on LCD is the user code. Restart to clear the user code and re-set.

Automatic Flush Button

Press "STOP" button, and then press "" button to set auto open/close mode. Repeat above action to stop this function. This key combination is only for toilet seats with auto open/close function. The auto open/close default setting is in the off state, so it needs to be turned on at first-use.

Remark:

By pressing the button, the signal indicator will flash which means the signal is sent out; Then the buzzer will "click", which means the main unit receives the signal and executes the instruction. If the signal indicator doesn't flash, that means the button is not effectively pressed and needs to be re-pressed. If the buzzer does not ring, that means the main unit did not receive the signal. Please regulate the remote control direction and re-press the button.

In case of power outage during wand's spray operation, the wand will not go back to place, please wait until the power is reset. In case of an elongate power outage, please push the wand softly back by hand. Do not push hard, to avoid damage to wand and electrical machine.

The body should touch the seat and the buzzer will "click", which means the functions of front cleaning, rear cleaning and drying are in operation. The nozzle will continue to spray for 1-2 seconds after user stands up during spray operation, so please press "STOP" button before standing up. Use nozzle self-cleaning function after user leaves the seat. After cleaning, if user doesn't press "NOZZLE CLEANING" or "STOP" button, nozzle wand will go back after 10 minutes.

Set Automatic Rear Cleaning Function

The default setting of the automatic water pressure, nozzle position, water temperature, wind temperature and seat temperature are on level three, the message function is in the off state. User can reset based on personal preference.

1. Adjust water pressure, nozzle position, temperature, and open/close message function with the function button (below circled in grey).

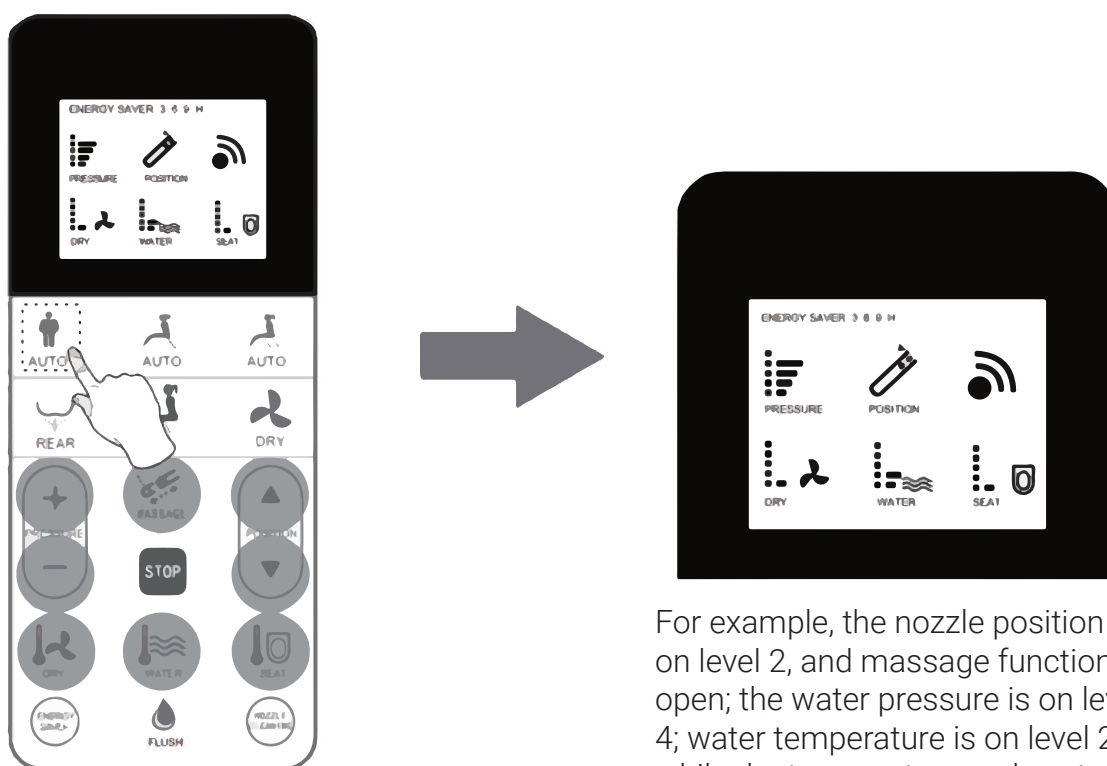

For example, the nozzle position is on level 2, and message function is open; the water pressure is on level 4; water temperature is on level 2, while dry temperature and seat temperature are on level 1.

2. After setting is completed, long press rear cleaning automatic button for 3 seconds to save the setting.

3. After above steps, quick press “”, LCD displays the previously saved settings of rear cleaning level, temperature level and message status. By this time, the toilet operates rear cleaning and then dries automatically without pressing other buttons.

4. During automatic rear cleaning, user still can change the level, temperature and message status, and press “REAR” button 3 seconds to save the new settings.

Set Automatic Front Cleaning Function

1. Press spray nozzle position adjustment button to adjust nozzle to suitable position; Press “+”, “-” to adjust water pressure; set temperature level; open/close massage function.

2. Press “” front cleaning automatic button for 3 seconds, see below picture, and save the setting.

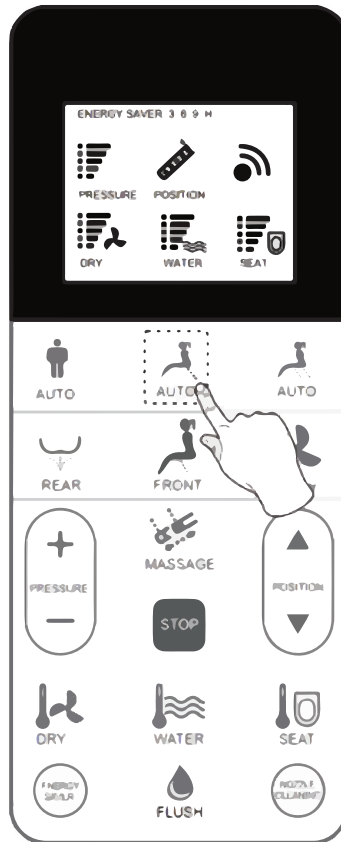

3. After above steps, quick press “”, LCD displays the previously saved settings of front cleaning level, temperature level and massage status. By this time, the toilet operates rear cleaning and then dries automatically without pressing other buttons.

4. During automatic front cleaning, user still can change the level, temperature and massage status, and press “FRONT” button 3 seconds to save the new setting.

Set Automatic Rear and Front Cleaning Combination Function

NOTE: During using toilet, user can find the suitable level and temperature after comparing repeatedly. Please set the automatic Rear and Front cleaning combination function during toilet usage.

The First Stage: Rear Cleaning

1. Automatic Rear and Front cleaning combination function includes rear cleaning, front cleaning and drying. User can adjust level and temperature in different stages.

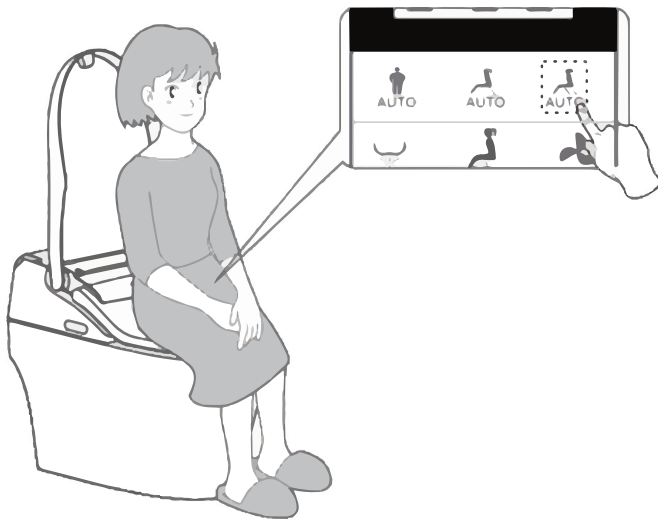

1. After user sits on the toilet, press automatic Rear and Front cleaning button, it starts to rear clean.
2. Adjust nozzle position, water pressure, wind temperature, seat temperature and open/close massage function during rear cleaning.
3. After adjusting the parameters, remote control saves the parameters under the first stage.
4. During adjusting, if user adjusts many times, the remote control saves the latest parameter.

The Second Stage: Front Cleaning

2. After finishing rear cleaning, toilet enters front cleaning stage automatically. User can set nozzle position, water pressure, temperature and open/close massage function, and the remote control saves the latest parameter under the second stage.

The Third Stage: Drying

3. After finishing front cleaning, toilet enters drying stage automatically. User can set wind temperature, and the remote control saves the latest parameter under the second stage.
4. After you set all parameters, quick press "AUTO" button, LCD displays the previous saved settings. By this time, the toilet operates rear cleaning, front cleaning and drying automatically by one-button operation. If user needs to change previous settings, please repeat steps 1-3.

ONE YEAR LIMITED WARRANTY

Swiss Madison® products are made with quality materials and excellent craftsmanship to provide our customers with beautiful, durable, long-lasting products. Should there be any defects in materials or craftsmanship under regular use that are discovered within the first year of installation, Swiss Madison® will provide replacement parts at no charge, or at its discretion, replace any product or part of the product that is deemed defective, under normal installation, use, service or maintenance. This warranty applies only to the original purchaser. Proof of purchase will be required in the instance of a claim.

Swiss Madison® recommends all installations of Swiss Madison® products to be conducted by a licensed, professional plumber or contractor. Swiss Madison® will not be held responsible for any damage or product failure due to improper installation, misuse, or failure to utilize a licensed professional for installation. Swiss Madison® is not responsible for any installation or removal costs.

This One Year Limited Warranty Will Be Voided If:

- The installation recommendations were not followed by the installer
- The product has been moved from its initial place of installation
- The product has in any way been modified from its packaged state
- The product has been subjected to improper maintenance, abuse, misuse, excessive use of chemicals, accidents, or other damages, etc.

Swiss Madison® makes no implication that its products comply with any local building or plumbing codes. It is the consumer's responsibility and obligation to determine local code compliance prior to and during installation. This warranty extends only to the original purchaser and first consumer.

Swiss Madison® is not responsible for any special, incidental or consequential damages associated with the installation, replacement, return or use of the original purchaser's product. This includes, but is not limited to: freight costs, labor, travel time, lost profit, home damages and other contingent liabilities and costs (including, without limitation, costs associated with 'professionals' or 'experts', investigations, audits, analyses, attorneys and any other professional/hired services).

The Swiss Madison® warranty is a comprehensive and explicit limit of liability. All items not disclosed within the warranty are not addressable within the responsibility of Swiss Madison®. Certain states have variances regarding implied warranties; in those situations, we remain fully compliant.

**If you have any questions or concerns, please contact us directly at
1-434-MADISON (623-4766)**

 **WARNING:** Contents of your order may contain sharp and possibly other harmful pieces and may cause hazard to children and adults. Swiss Madison® is not responsible in any way for personal damages.