

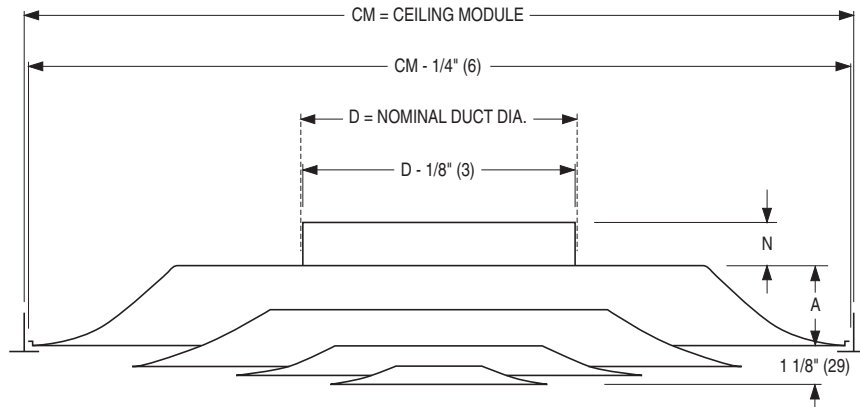

SQUARE CEILING DIFFUSERS
FIXED PATTERN • LOUVERED FACE
STEEL • ROUND NECK • 4 CONE
MODEL: RNS

TYPE L Lay-in T-Bar



Dimensional Data

Ceiling Module CM		Imperial Units (inches)					Metric Units (mm)				
Imperial Modules	Metric Modules	Duct Size D	N	A	B	F	Duct Size D	N	A	B	F
12 x 12	300 x 300	4*	3 1/4	1	11	13	102*	83	25	279	330
		5, 6, 7, 8	1 1/4				127, 152, 178, 203				
24 x 24	600 x 600	6, 8, 10, 12, 14, 15	1 1/4	2 5/16	22	24 3/4	152, 203, 254, 305, 356, 381	32	59	559	629

* Supplied with a reducer.

DESCRIPTION:

1. Material: Heavy gauge, corrosion-resistant steel.
2. The diffuser delivers the air in a true 360° radial horizontal pattern. Designed to minimize smudging and streaking of ceiling.
3. Excellent for VAV systems. The uniform near horizontal jets from the louvered cones maintain effective air motion over a considerable range of air volumes.
4. The models consist of four die-formed concentric cones in all sizes which eliminate mitered corners and provide uniform appearance in all neck sizes.
5. A spring clip arrangement permits quick, easy installation and removal of the inner cone assembly.
6. Diffuser has a removable plug for screwdriver adjustment of the optional damper without removing the inner core.
7. Standard finish is AW Appliance White.

OPTIONS:

- EX External Foil-Back Insulation, installed - R-4.2
- EXB External Foil-Back Insulation, ships loose - R-4.2
- MIB Molded Insulation Blanket - R-6.0 (24 x 24 only)
- EQT Earthquake Tabs

Finish:

- SP Special. Specify _____.

QB Quadrant Blanks:

- QB3 3-Way Blow
- QC2 2-Way Corner Blow
- QB2 2-Way Opposite Blow
- QB1 1-Way Blow

Dimensions are in inches (mm). Fineline® is a registered trademark of USG Interiors Inc.

TYPE L Surface Mount

Hard duct connection recommended.

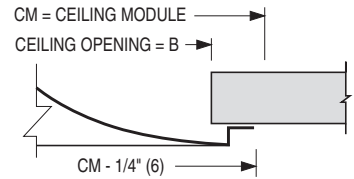

TYPE L Surface Mount With DFA

Drywall/Plaster frame. Recommended for flexible duct connection and ceiling access

CEILING OPENING = CM + 1/4" (6) SUPPLIED WITH SEPARATE DFA FRAME

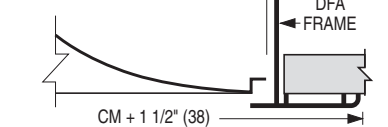

TYPE S Surface Mount

CM = CEILING MODULE
 CEILING OPENING = CM - 1" (25)

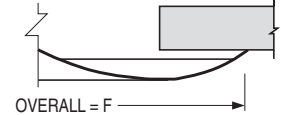

TYPE F Fineline®

CM = CEILING MODULE
 CM - 1/4" (6)

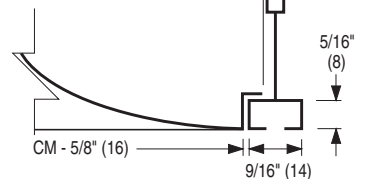

TYPE M Metal Pan (Snap-in)

CM = CEILING MODULE

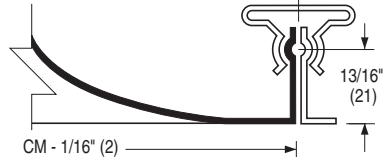

TYPE SP Spline

For one directional exposed T-Bar or fully concealed grid. 1 spline on two opposite sides. Steel lift brackets on other.

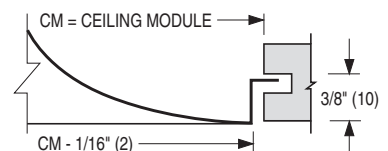

SCHEDULE TYPE:

PROJECT:

ENGINEER:

CONTRACTOR:

DATE

B SERIES

SUPERSEDES

DRAWING NO.

3 - 18 - 16

RNS

10 - 31 - 07

4200-1