

Vinyl Cash Tag Wristbands (Available in 1, 2, 3, 4, 5, 7 & 10 tabs)



FEATURES:

- Features tabs that can be custom printed
- Three layers of vinyl material for extra durability
- Secure, one-time-use snap closure
- Recommended use: 7-14 days
- Adjustable, comfortable, tear and stretch resistant
- Custom imprinting, barcoding and custom numbering available

DESCRIPTION:

Vinyl Cash Tag Wristbands are available in 1, 2, 3, 4, 5, 7 & 10 easy to remove tabs that allow for added control and accountability perfect for raffles, food, drinks, etc. The tabs can be custom printed with logos or text. The wristbands are made from three layers of vinyl material making them the most durable wristband on the market. They employ a one-time-use plastic snap closure requiring the wristbands to be cut off after use. The backside of every wristband is white, while the front side is the color of your choice, with the exception of edge glow and frosty clear which has a clear backer.

ALL TAB OPTIONS AVAILABLE IN COLORS BELOW:



-01
Neon Green



-02
Neon Yellow



-03
Neon Red



-04
Neon Orange



-05
Neon Blue



-07
Neon Pink

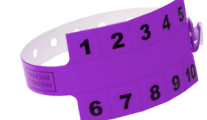

-08
Purple



-09
White



-10
Black



-11
Gold



-12
Silver



-15
Navy Blue



-29
Forest Green



-30
Teal



-20
Frosty Clear
(Transparent)



-21
Edge Glow
Yellow



-23
Edge Glow
Green



-24
Edge Glow
Red



-25
Edge Glow
Orange



-26
Edge Glow
Blue



-27
Edge Glow
Pink



-28
Edge Glow
Purple

Vinyl Cash Tag 1 Tab Wristbands

ORDERING INFORMATION:

Model Number: VC1

Name: Vinyl Cash Tag 1 Tab Wristbands

Quantity: 500 per pack

SPECIFICATIONS:

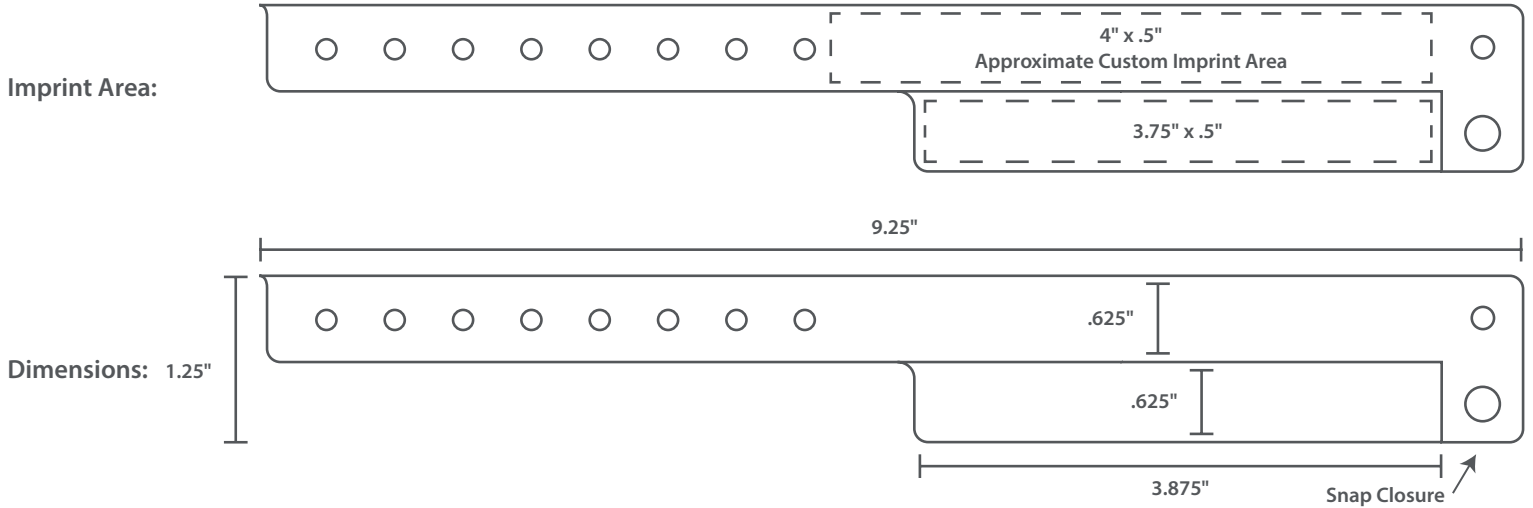

Vinyl Cash Tag 2 Tab Wristbands

ORDERING INFORMATION:

Model Number: VC2

Name: Vinyl Cash Tag 2 Tab Wristbands

Quantity: 500 per pack

SPECIFICATIONS:

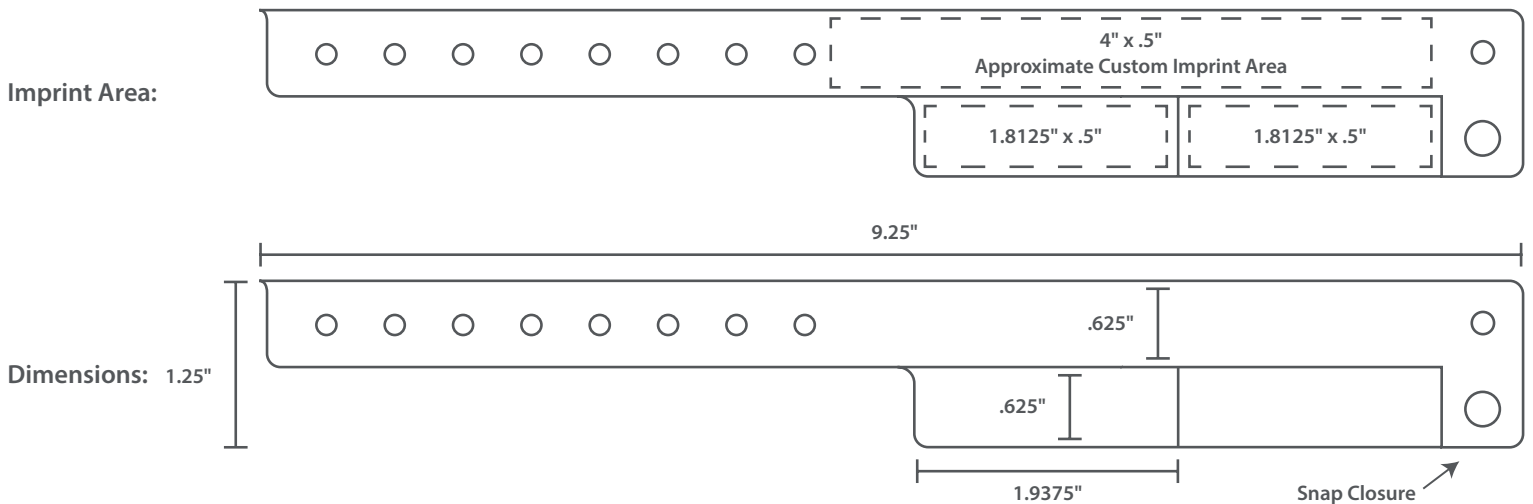

Vinyl Cash Tag 3 Tab Wristbands

ORDERING INFORMATION:

Model Number: VC3

Name: Vinyl Cash Tag 3 Tab Wristbands

Quantity: 500 per pack

SPECIFICATIONS:

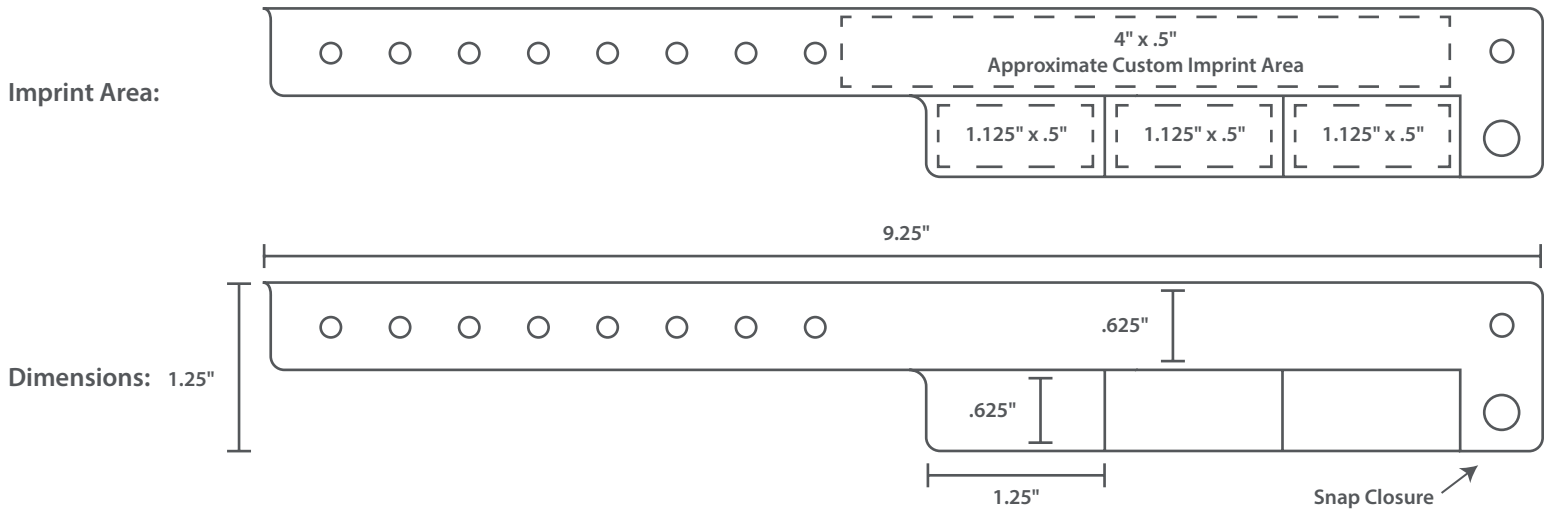

Vinyl Cash Tag 4 Tab Wristbands

ORDERING INFORMATION:

Model Number: VC4

Name: Vinyl Cash Tag 4 Tab Wristbands

Quantity: 500 per pack

SPECIFICATIONS:

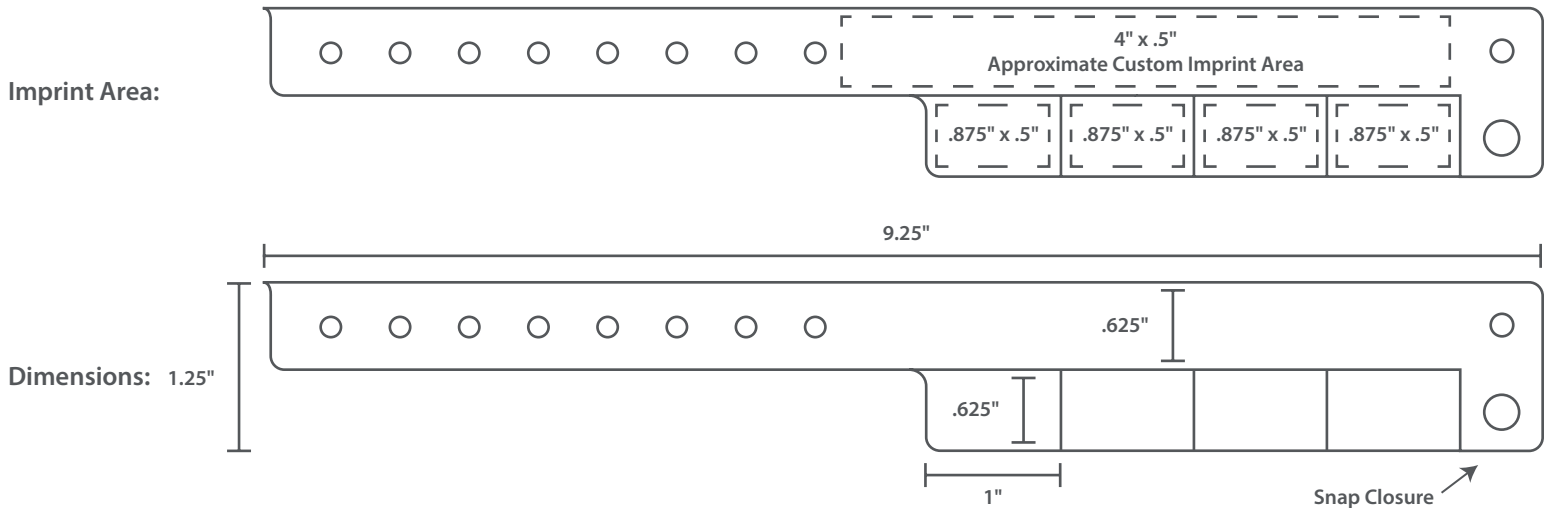

Vinyl Cash Tag 5 Tab Wristbands

ORDERING INFORMATION:

Model Number: VC5

Name: Vinyl Cash Tag 5 Tab Wristbands

Quantity: 500 per pack

SPECIFICATIONS:

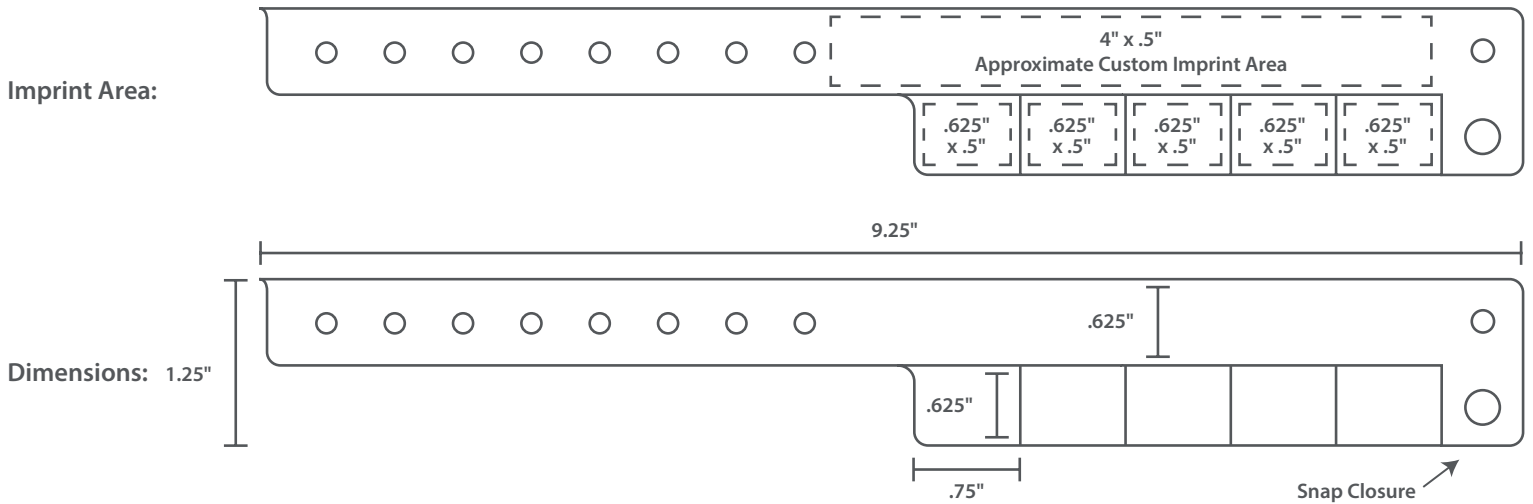

Vinyl Cash Tag 7 Tab Wristbands

ORDERING INFORMATION:

Model Number: VC7

Name: Vinyl Cash Tag 7 Tab Wristbands

Quantity: 500 per pack

SPECIFICATIONS:

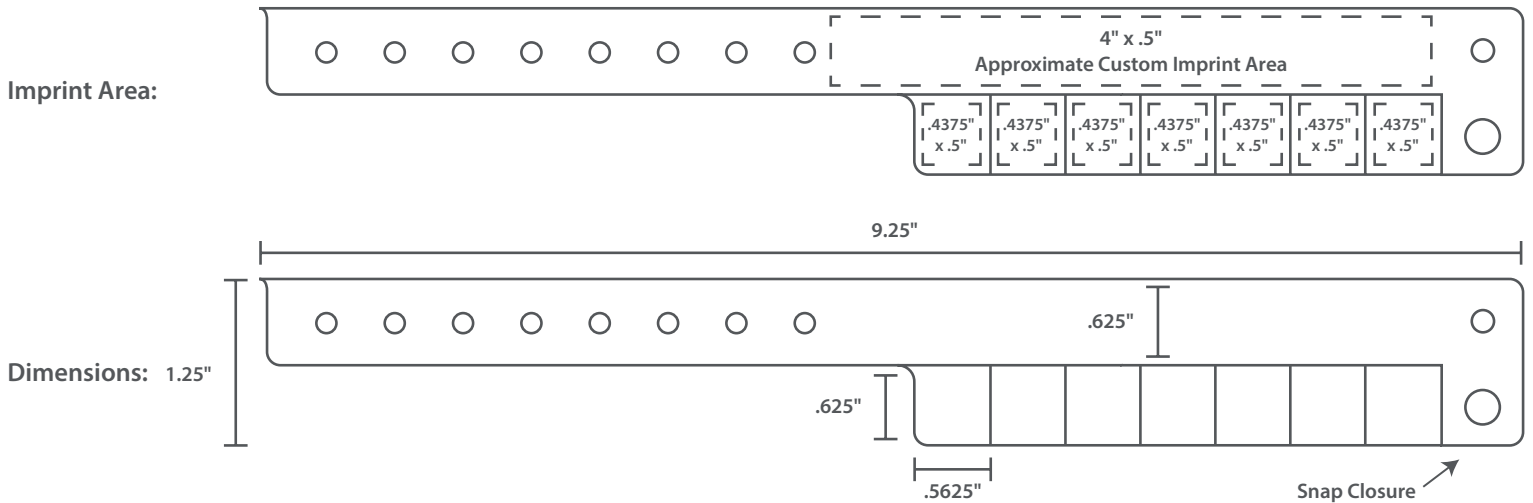

Vinyl Cash Tag 10 Tab Wristbands

ORDERING INFORMATION:

Model Number: VC10







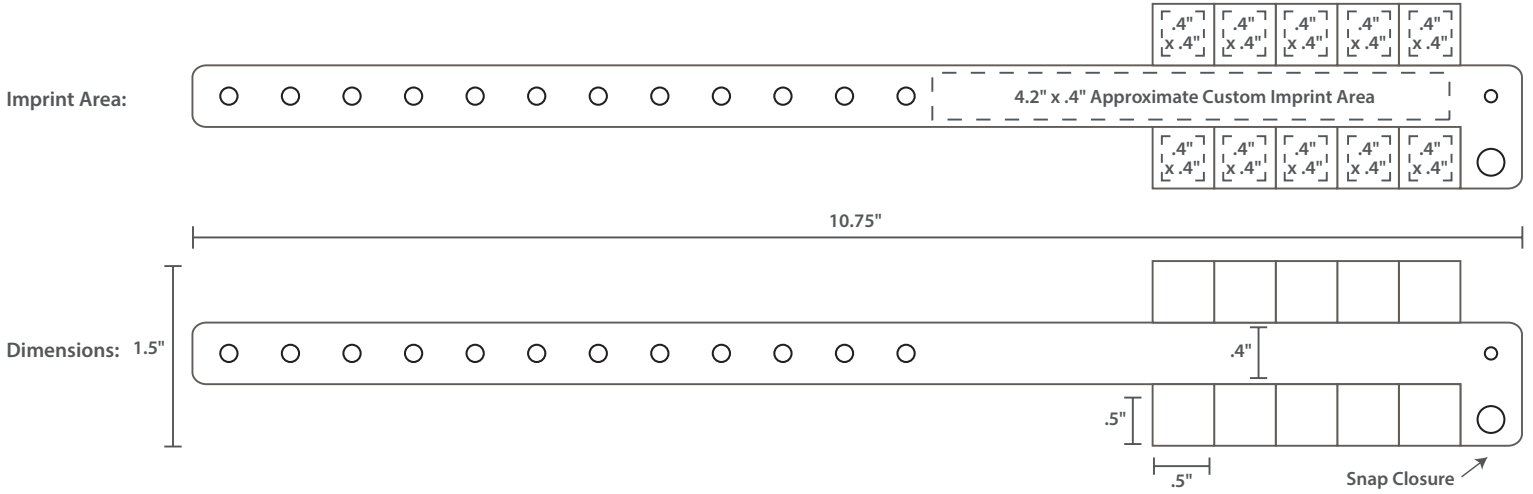





Name: Vinyl Cash Tag 10 Tab Wristbands

Quantity: 500 per pack

SPECIFICATIONS:



ANY CUSTOMIZATION (LOGO AND TEXT) CAN BE PRINTED IN THE FOLLOWING COLORS:

	Black		Process Blue		Orange PMS 021
	White		Pantone Yellow		Pantone Purple
	Red PMS 199		Gold PMS 873		Purple-Pantone Violet
	Green PMS 348		Silver PMS 877		
	Reflex Blue		Pink PMS 212		

PMS color match available for an extra fee

