



STEALTHPIVOT

By PortaPivot

TECHNICAL DOCUMENTATION



01/ Stealthpivot NL & XL



STEALTHPIVOT NL

- ▶ For doors up to 1250 mm wide
- ▶ Max. weight 75 kg (165 lbs)
- ▶ Maintenance free
- ▶ Silent 90° hold function
- ▶ 90° stop or 360° rotation

STEALTHPIVOT XL

- ▶ For doors up to 2250 mm wide
- ▶ Max. weight 150 kg (330 lbs)
- ▶ Maintenance free
- ▶ Silent 90° hold function
- ▶ 90° stop or 360° rotation

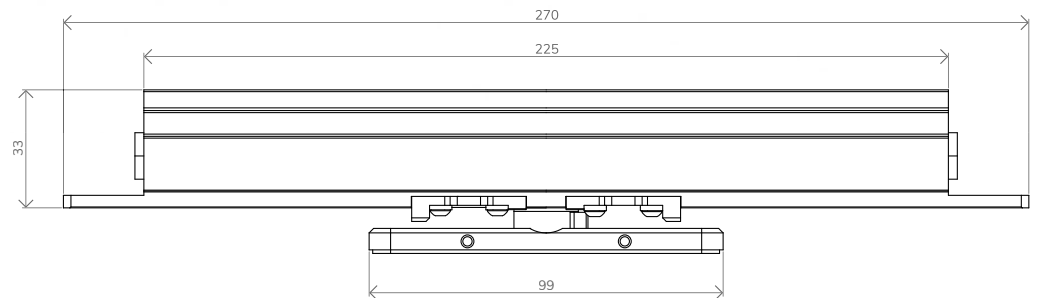
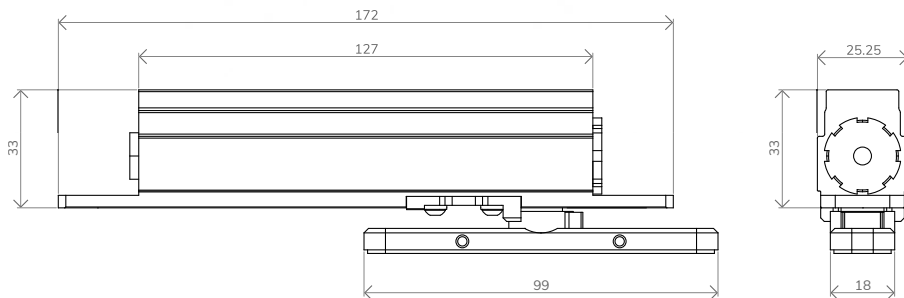

02/ Easy installation

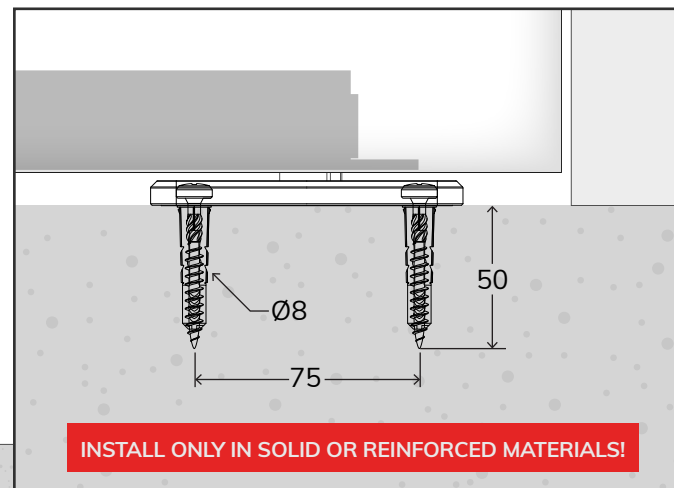
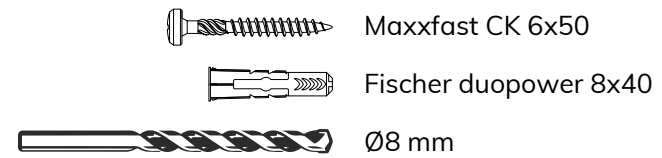
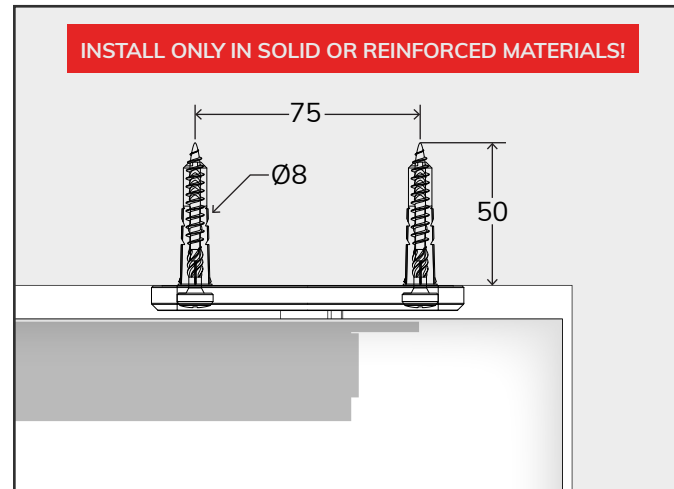
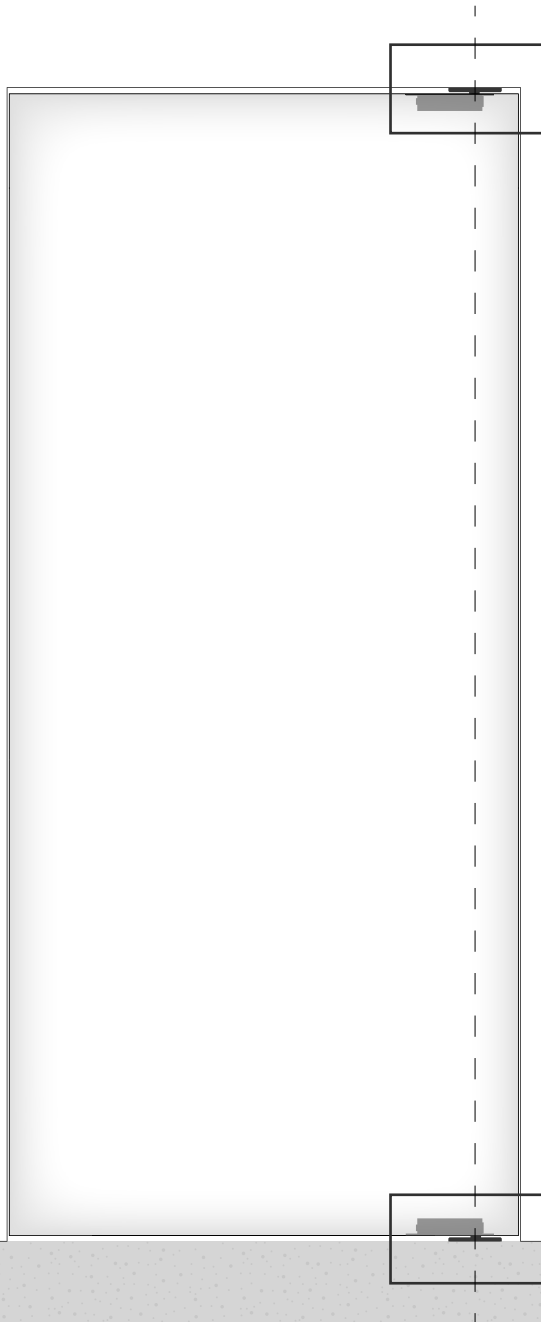

03/ Advised joint dimensions

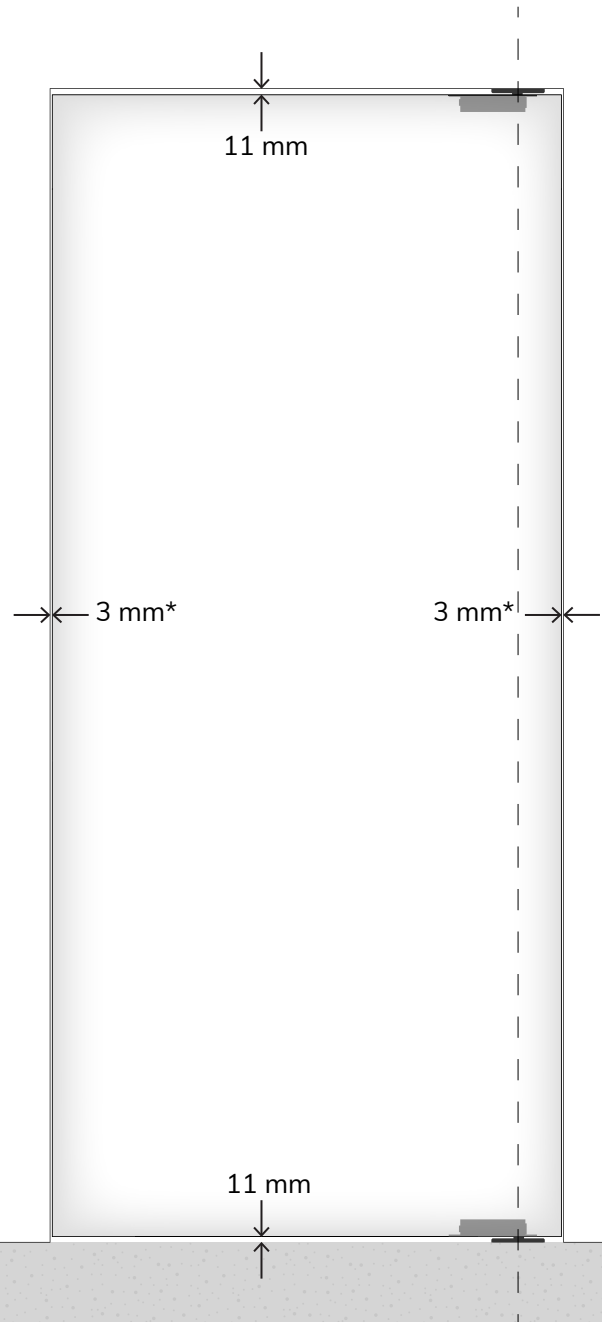

Top & bottom joints: min. 11 mm

***Left & right joints:**

The minimum joint depends on the door thickness and pivot distance. For visual coherence, we advise to use equal joints left and right. See visual and table below for advised left and right joint dimensions.

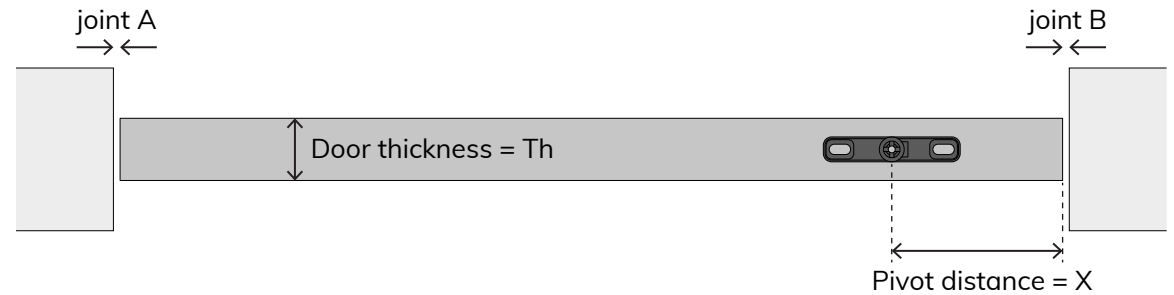

X▼	joint A & B			
1000	2	2	2	3
500	2	2	3	3
250	3	3	3	4
85	3	4	5	7
Th▶	30	40	50	60

04/ Door specifications

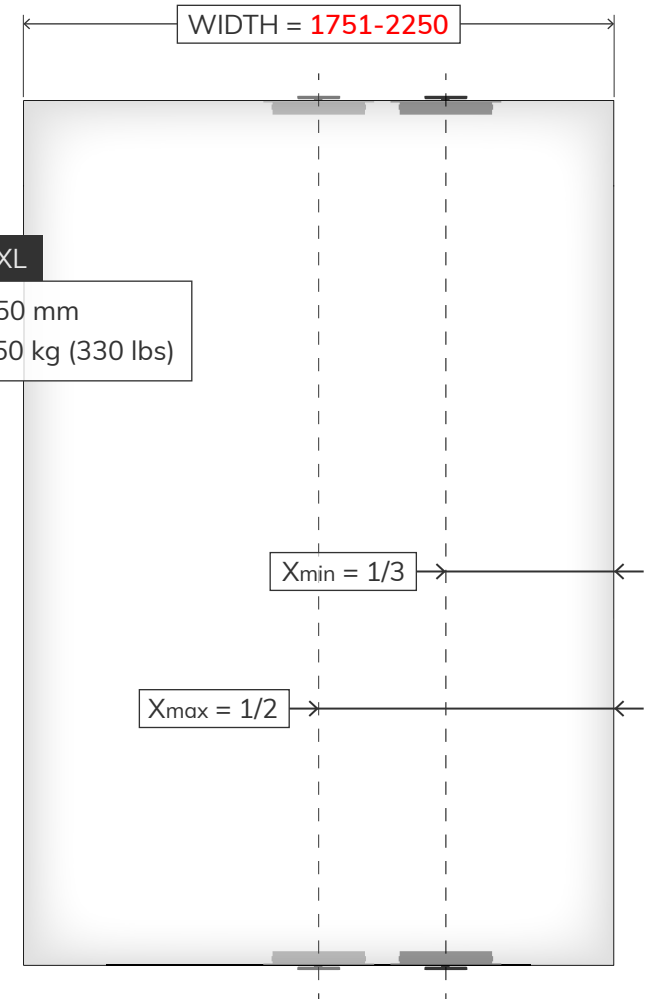
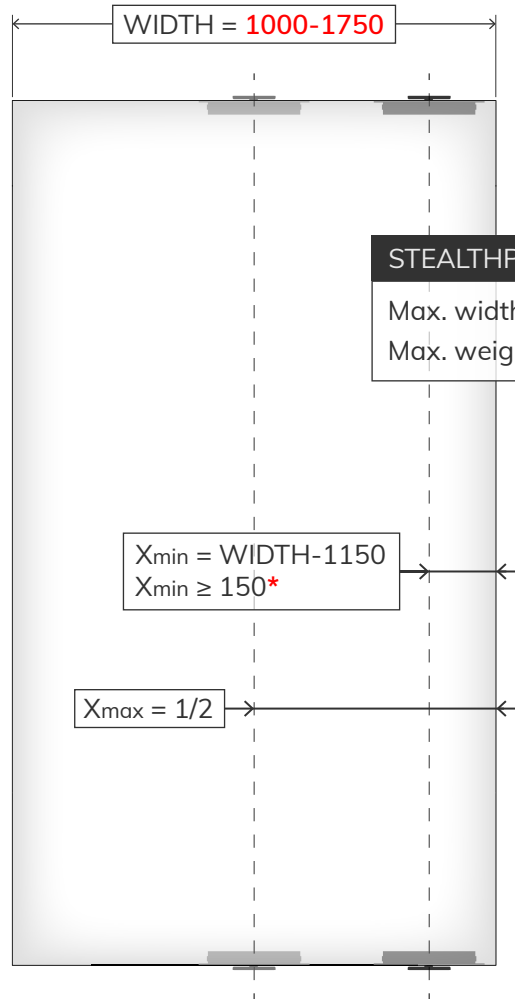
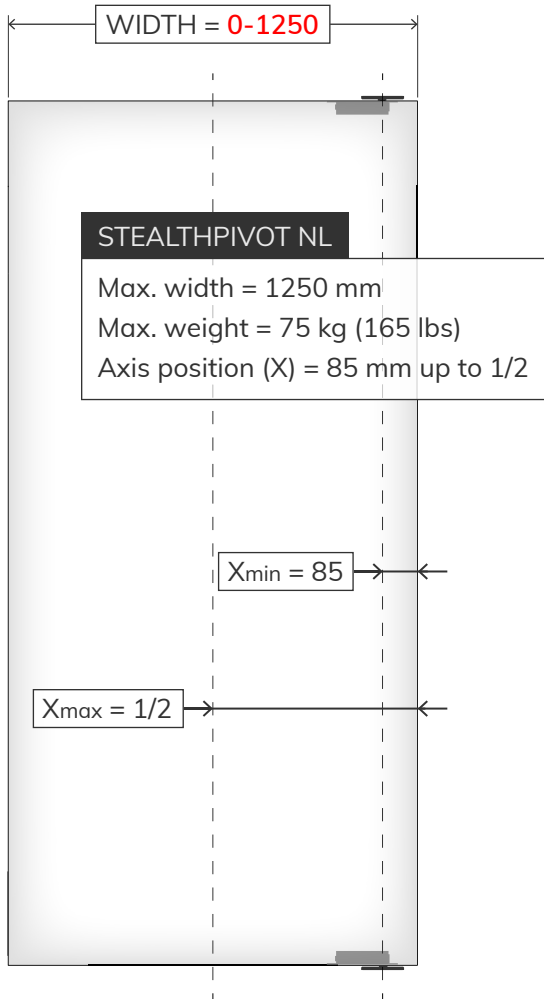

EXAMPLES

Door WIDTH ▶	1100	1200	1350	1500
$X_{min} = W - 1150$ ▶	-50	50	200	350
$X_{min} \geq 150$ ▶	no	no	yes	yes
* X_{min} result ▶	150	150	200	350

EXAMPLES

Door WIDTH ▶	1751	1800	2100
$X_{min} = 1/3$ ▶	584	600	700

05/ Door rotation and 90° hold

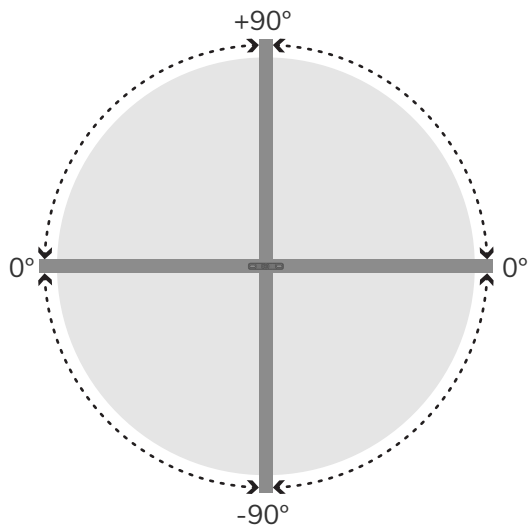

360° rotation with 90° hold

By simply rotating the S90 position, you unlock 360° functionality. The built-in silent hold function activates at +90°, 0° and -90°.

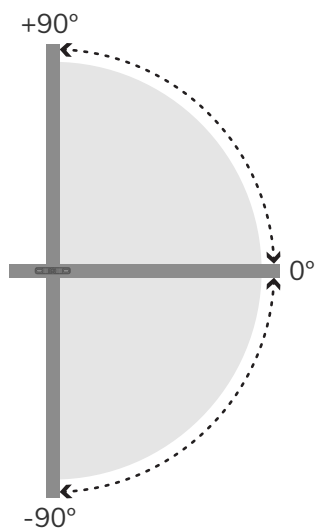
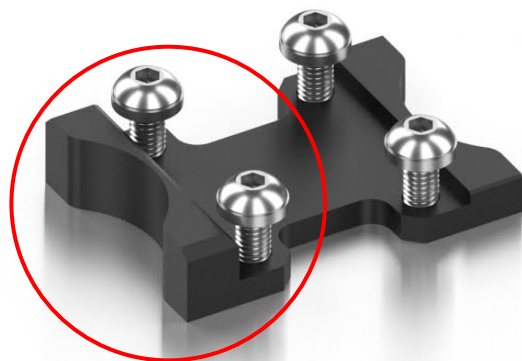

180° rotation with 90° hold

With the S90 installed (thick part against the pivot center), the hinge will stop at +90° and -90°. The built-in silent hold function activates at +90°, 0 and -90°.



06/ Self-closing function

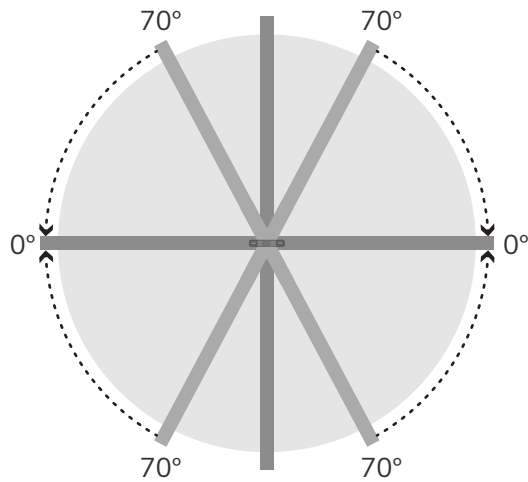

The pivot hinge will start to self-close from a 70° angle.

Both pivot hinge systems are equipped with 480N gas dampers which can easily be replaced.

Optional 750N dampers are also available.



07/ Optional 0° positioning systems

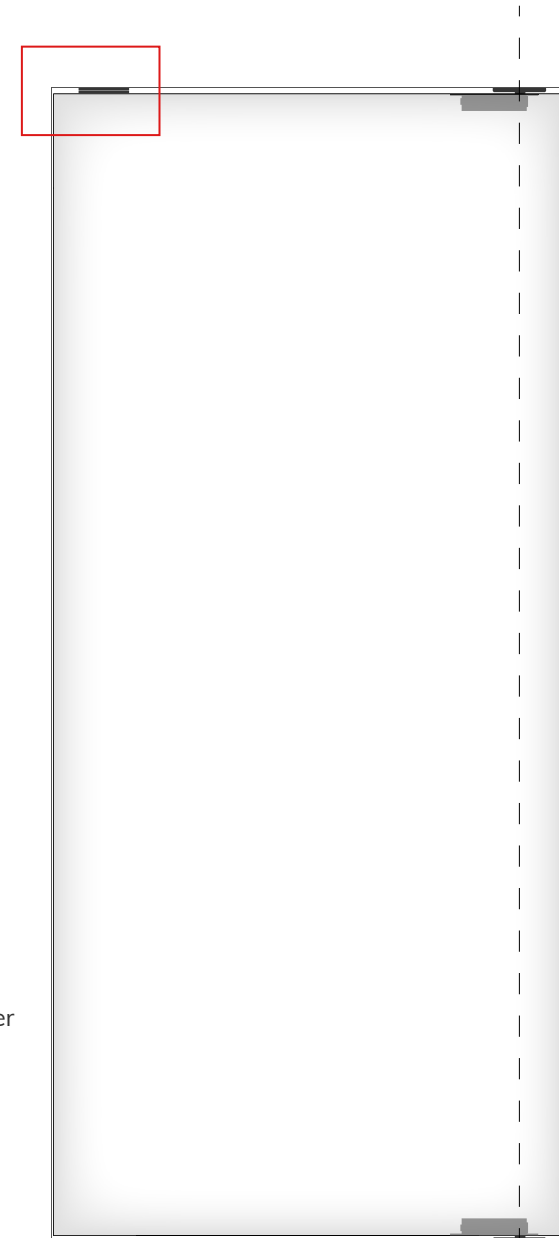
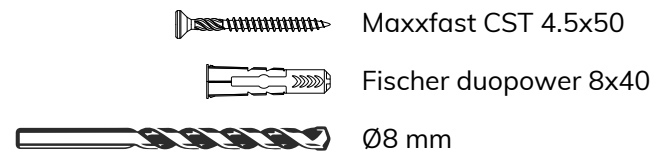
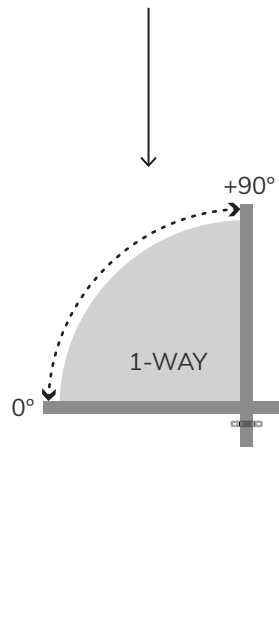
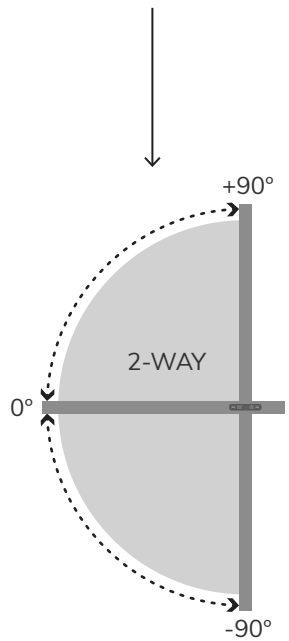
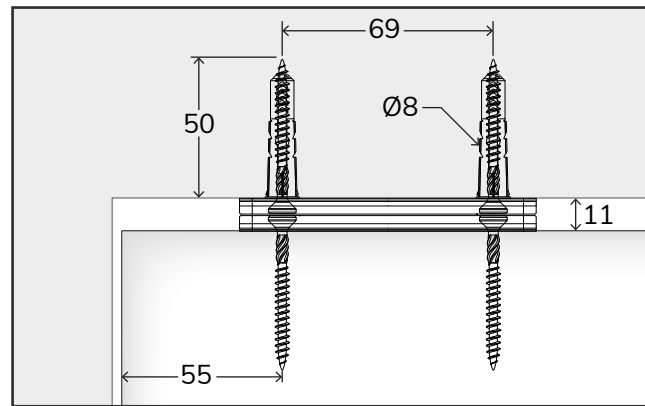
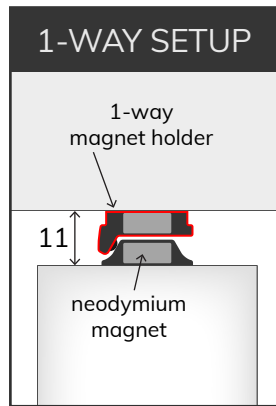
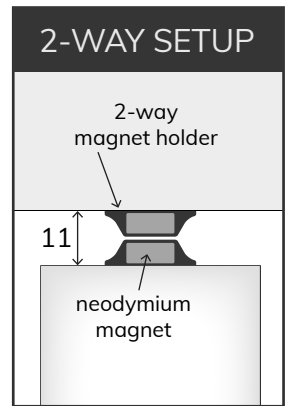

08/ Pivot mount cover

3D printed parts slide and snap over the base of the hinge to cover up the screws and hexagonal inserts.

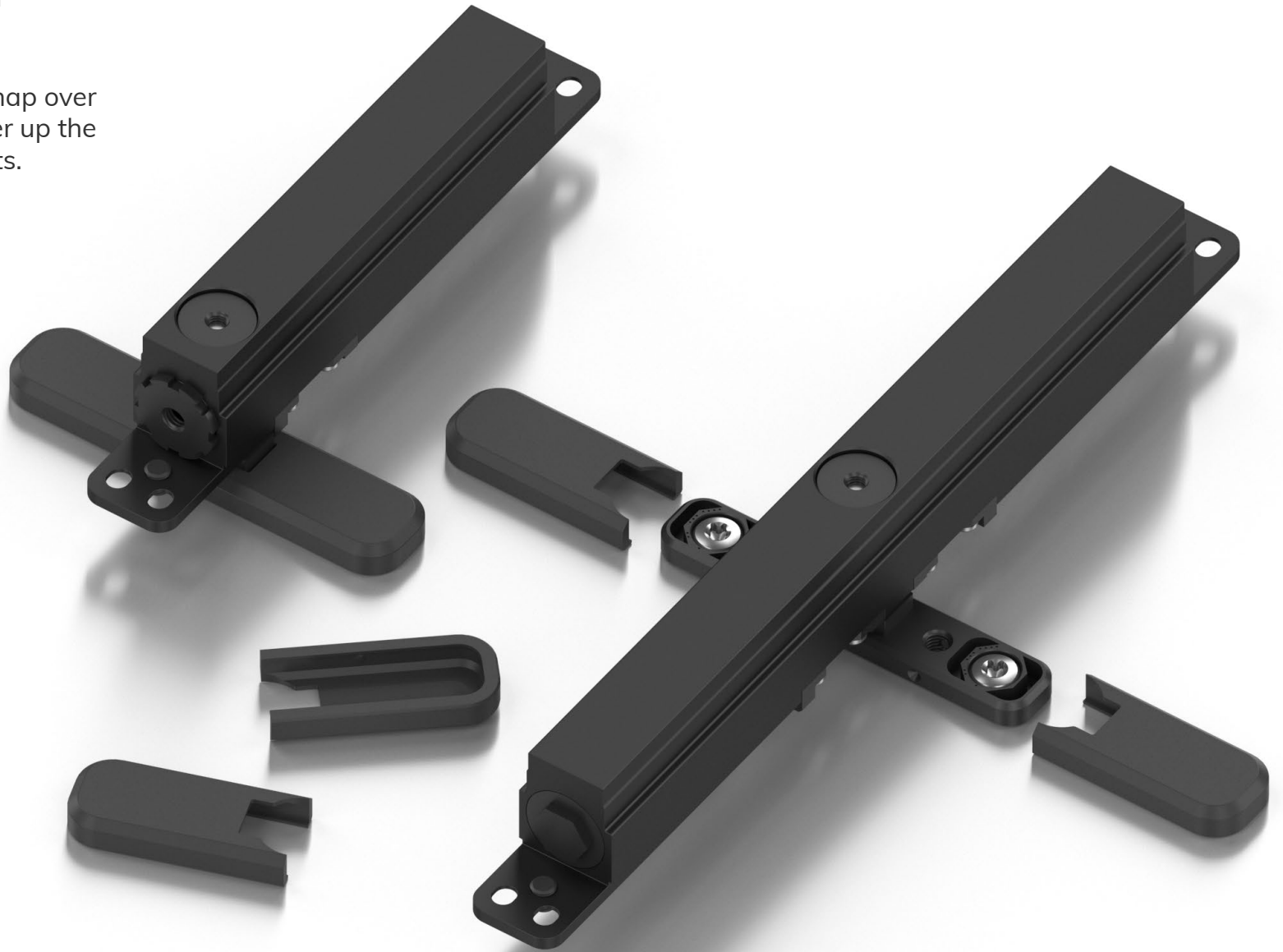

09/ Stealthpivot cavity dimensions (mm)



STEALTHPIVOT NL

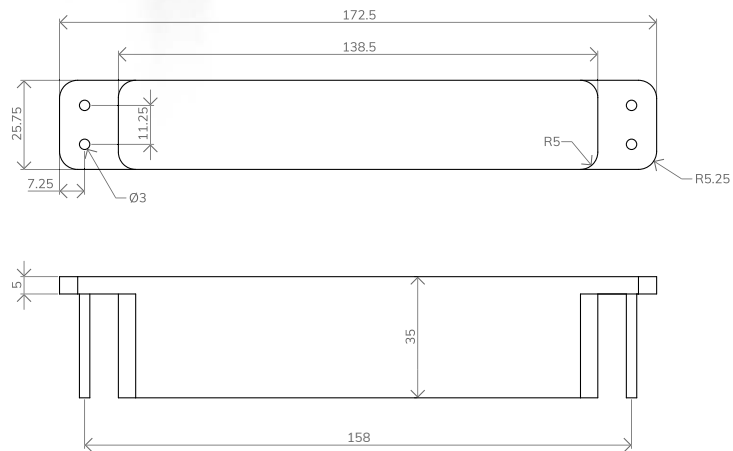

STEALTHPIVOT XL

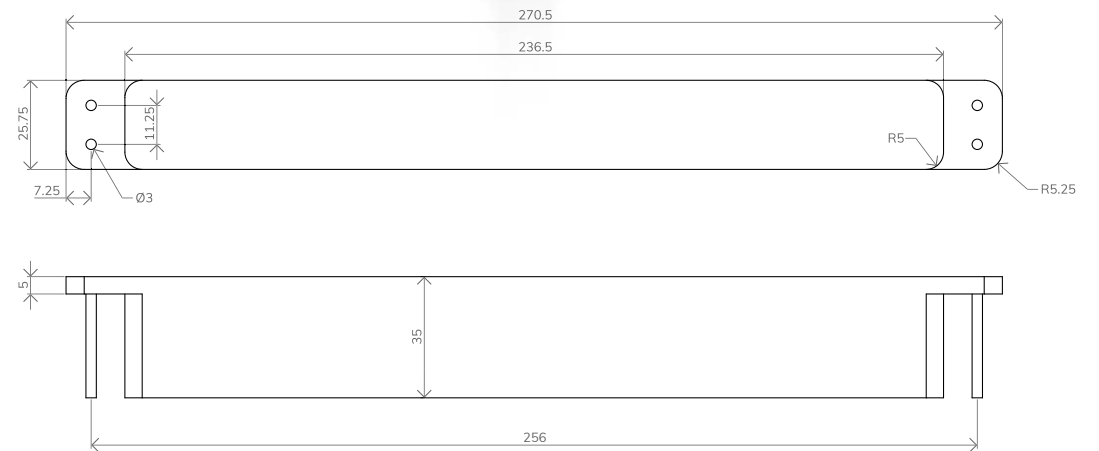

STEALTHPIVOT NL SET

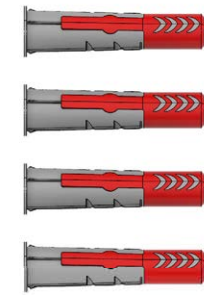
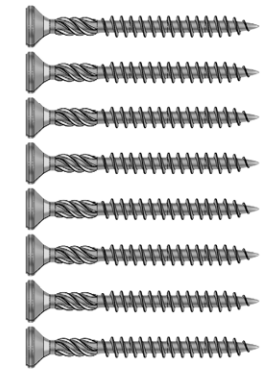
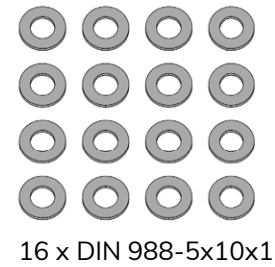
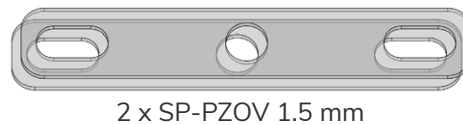
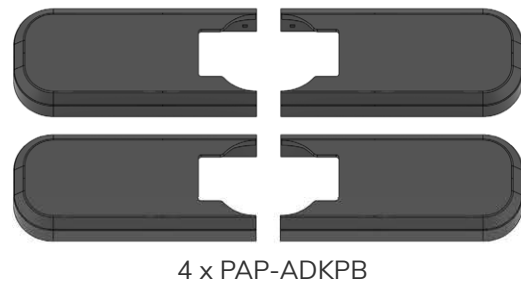
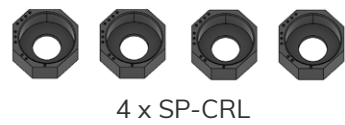

STEALTHPIVOT XL SET

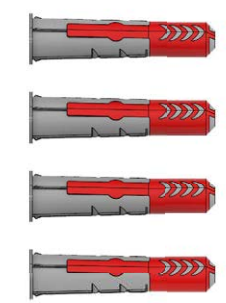
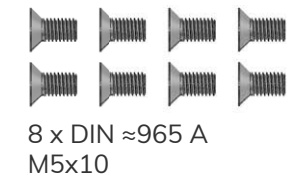
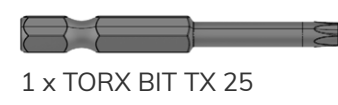
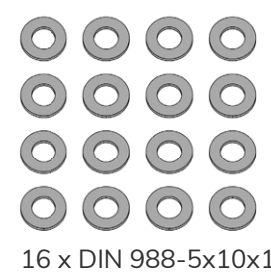
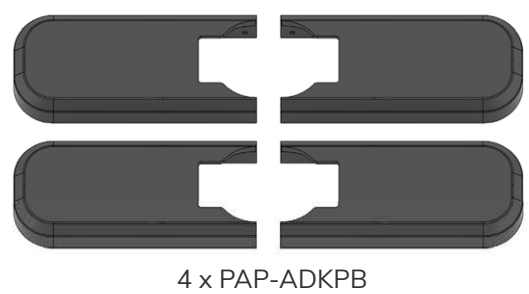
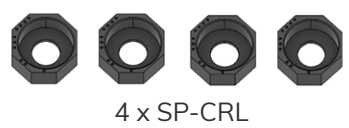
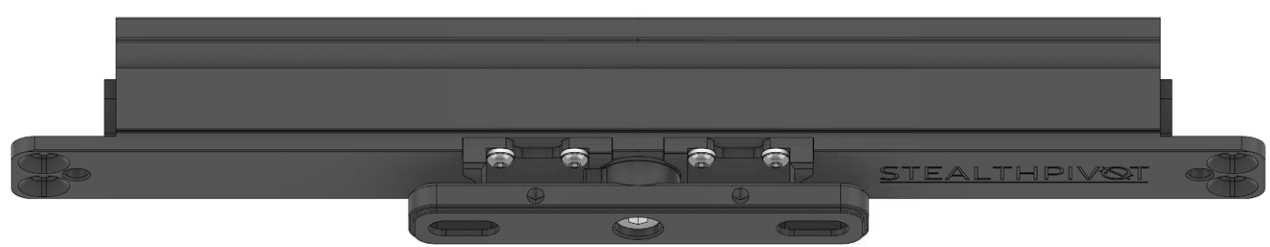

OPTIONAL STEALTHPIVOT NL ACCESSORY SET



1 x PAP-1W



2 x magnet South/North



8 x Maxxfast CST 4.5x50



2 x PAP-2W



4 x ISO 10642 - M4x8



4 x Fisher Duopower 8x40

OPTIONAL STEALTHPIVOT INSTALLATION TOOL

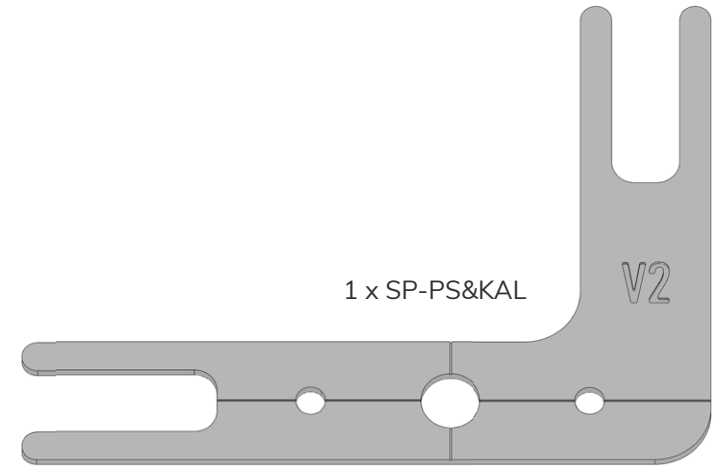

1 x SP-PS&KAL

V2

OPTIONAL STEALTHPIVOT XL ACCESSORY SET



2 x PAP-1W



4 x magnet South/North

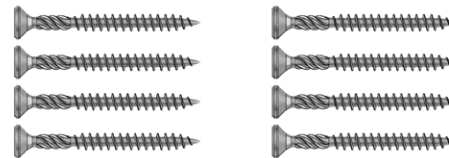

8 x Maxxfast CST 4.5x50

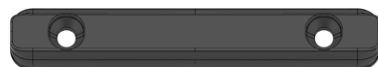
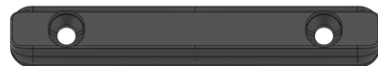

4 x PAP-2W

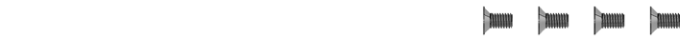

4 x ISO 10642 - M4x8



2 x SP-PZOV 1 mm



4 x Fisher Duopower 8x40



2 x SP-PZOV 1.5 mm