



STEALTHPIVOT

By PortaPivot

GRID MANUAL
FOR 5730, 3530 & MINIMAX



DELIVERED PARTS & RECOMMENDED TOOLS

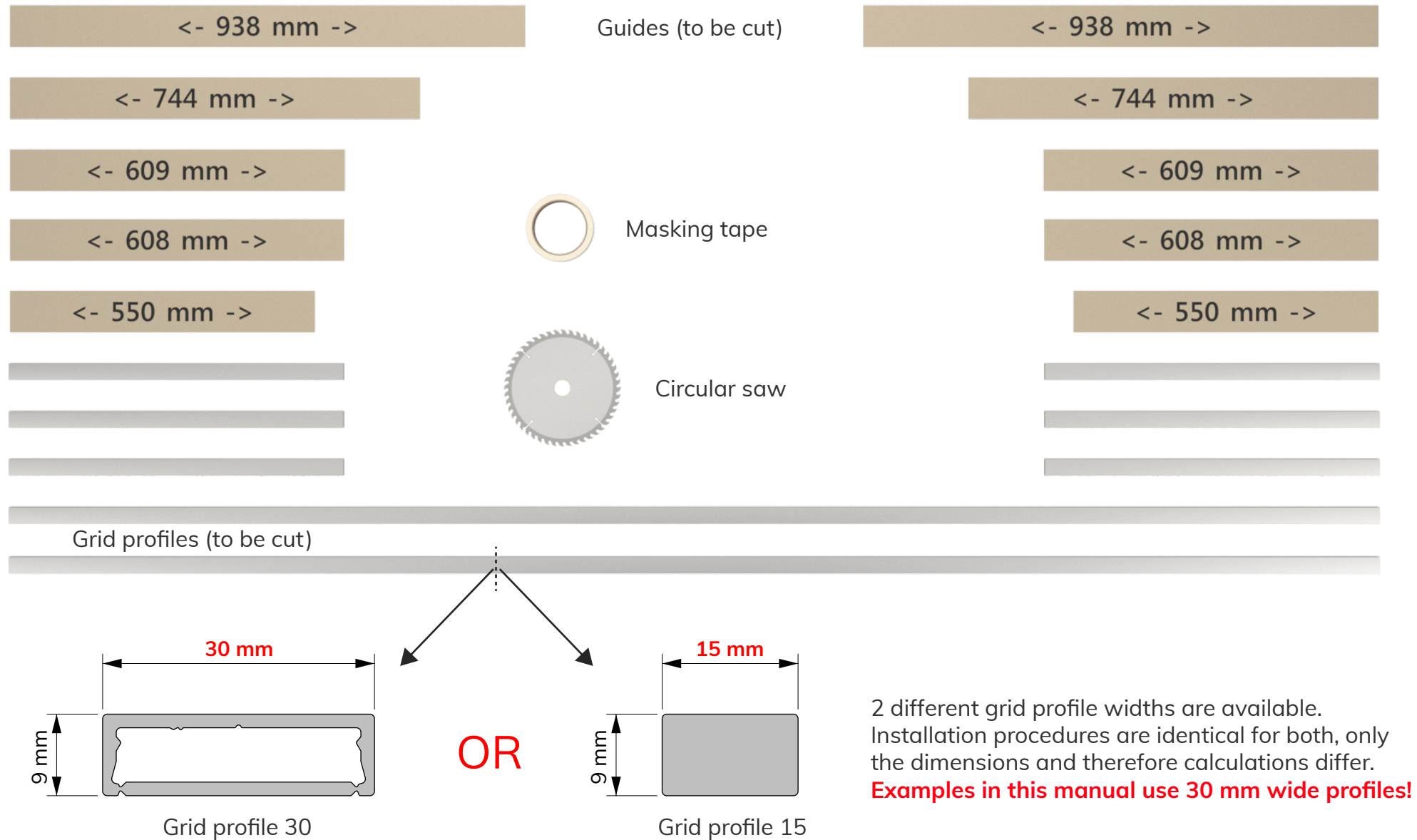

2 different grid profile widths are available. Installation procedures are identical for both, only the dimensions and therefore calculations differ. **Examples in this manual use 30 mm wide profiles!**

PREPARE PROFILES

- ① Design your grid pattern
TOP

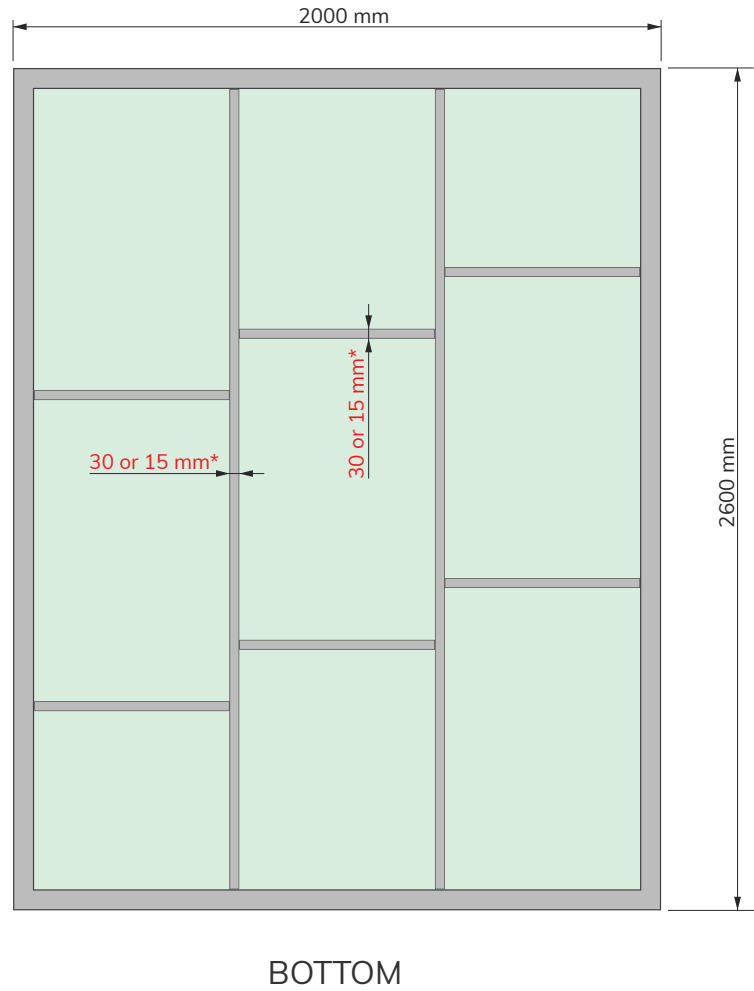

- ② Calculate grid profile lengths
TOP

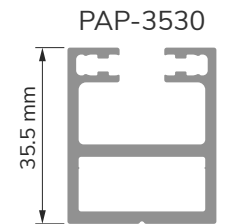
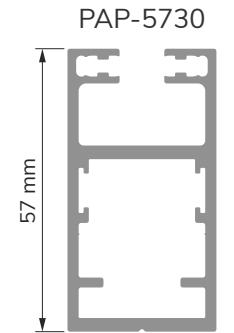
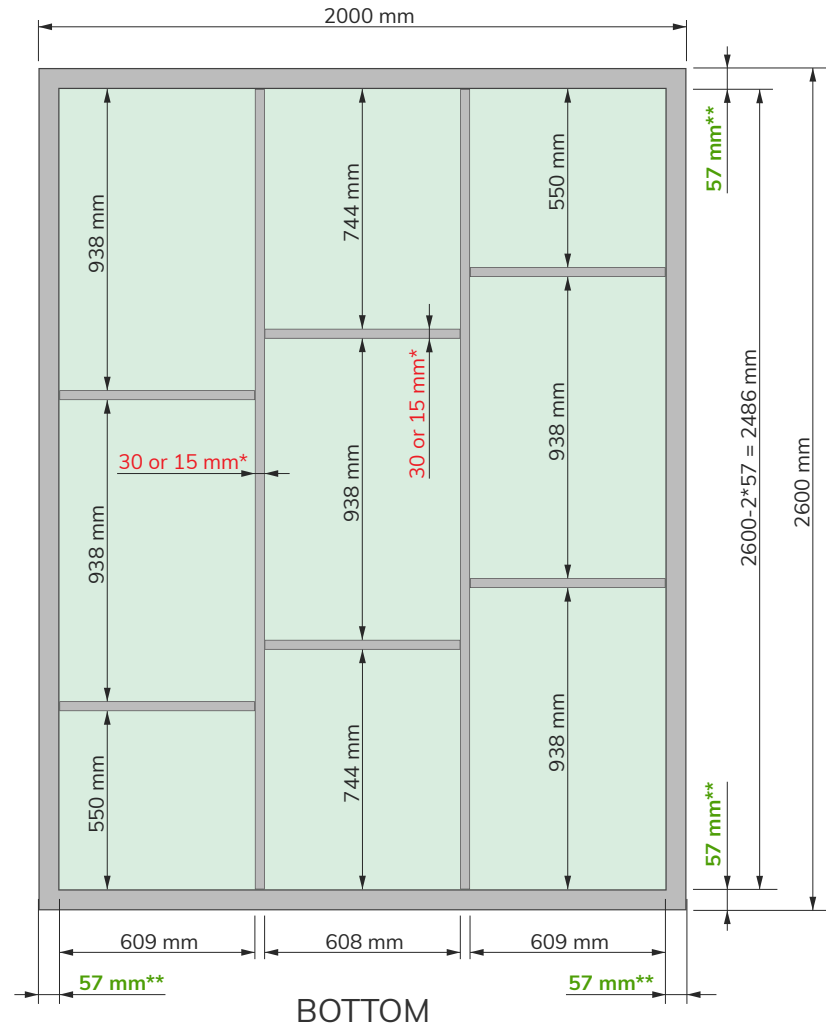

*DEPENDS ON YOUR CHOICE, SEE PAGE 2

**DEPENDS ON YOUR DOOR TYPE, SEE PROFILE DRAWINGS ABOVE

③ Remove adhesive tape around cut line

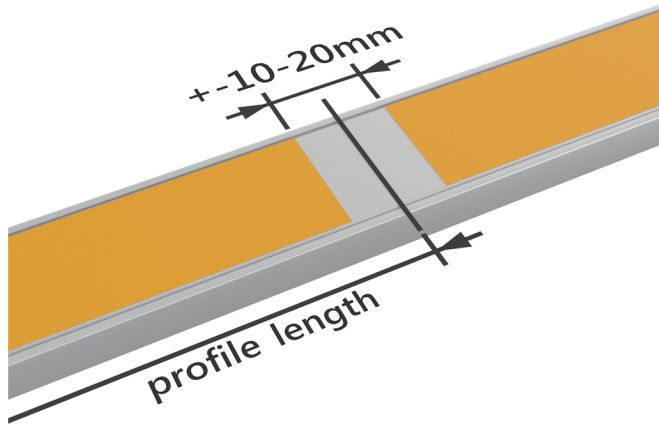

④ Cut grid profiles

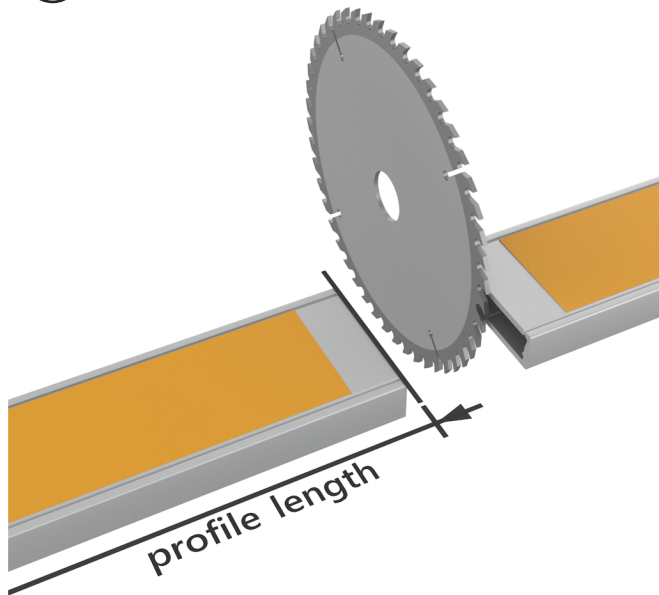

⑤ Calculate guide lengths

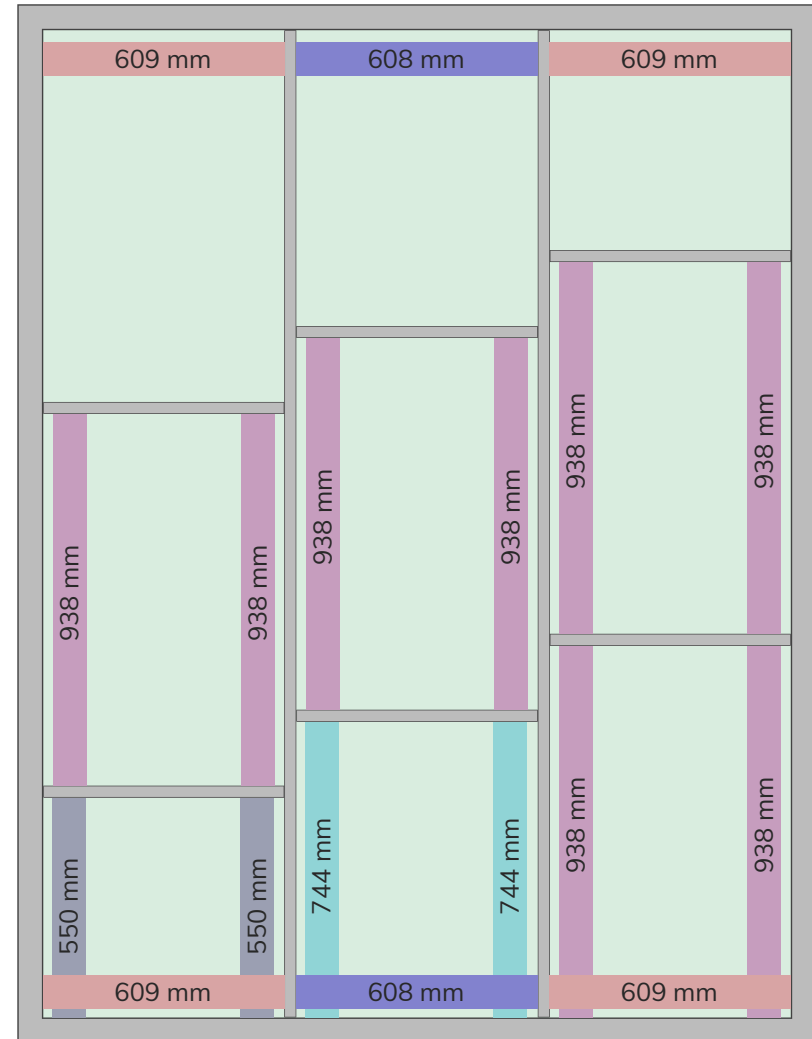

Example measurements in this manual use 30 mm wide grid profiles on a 5730 door!

⑥ Cut guides (2 of each length)

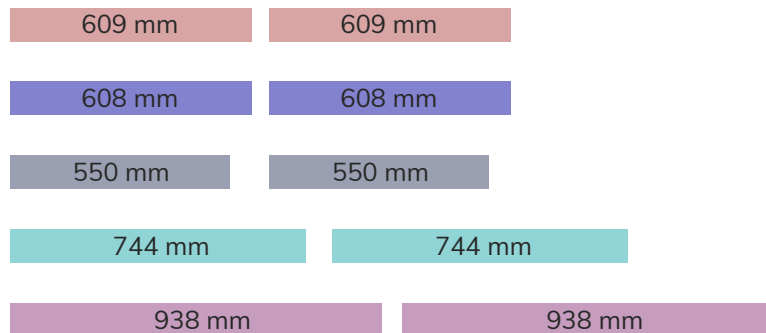

Example measurements in this manual use 30 mm wide grid profiles on a 5730 door!

⑦ Degrease panel (preferably with isopropyl alcohol)

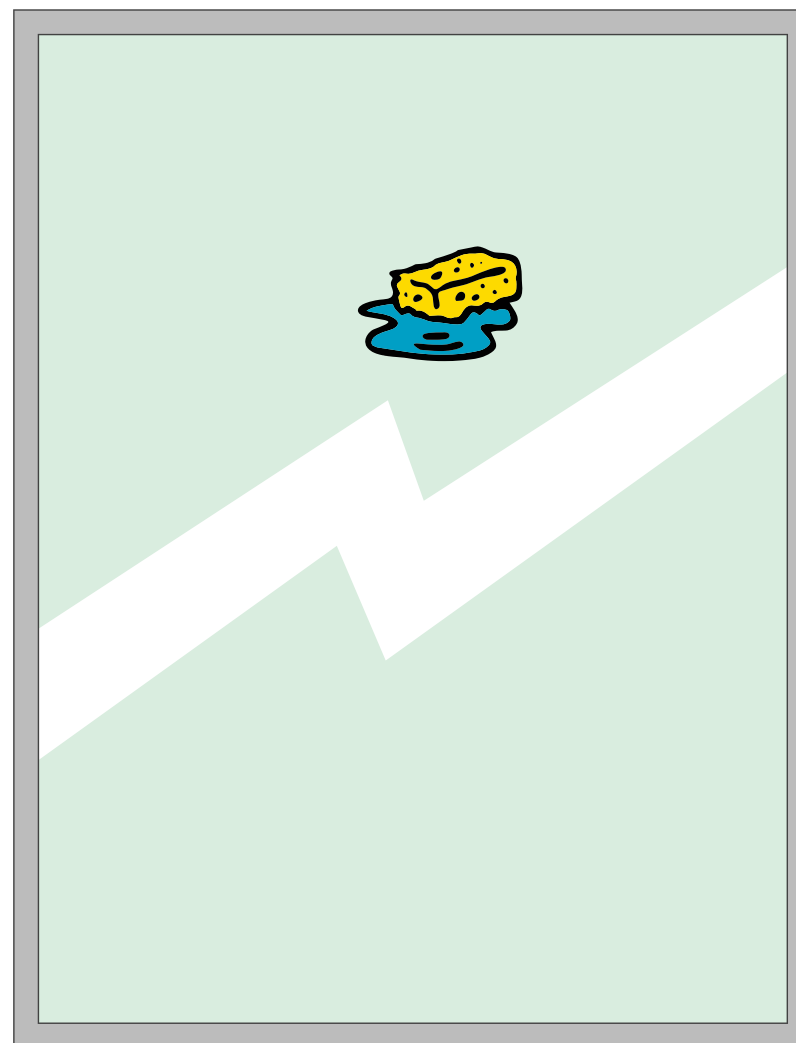

MOUNT GRID PROFILES ONTO THE GLASS PANEL

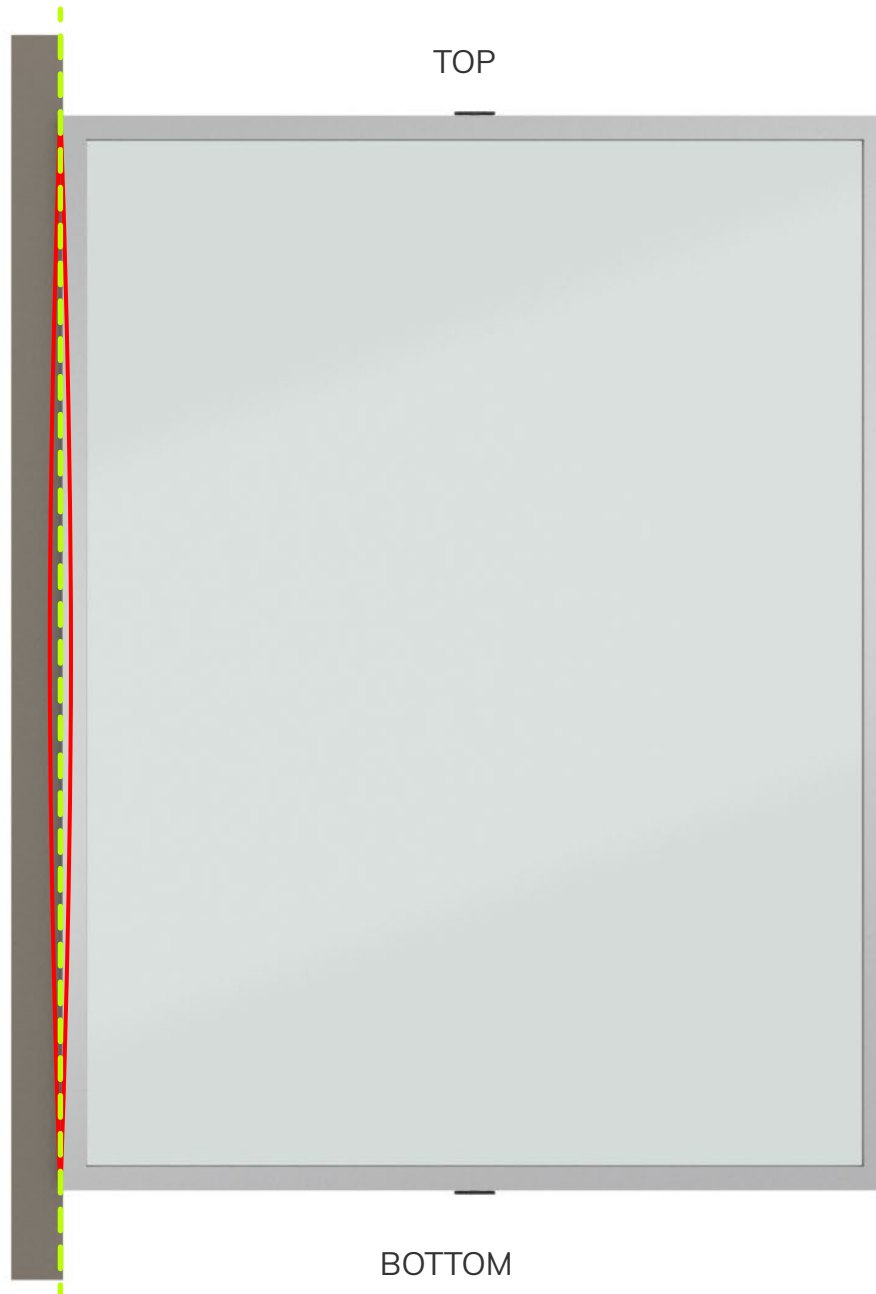

Make sure the starting profile is 100% straight! If not, use a rubber hammer to straighten profile.



Place the correct length guide in the bottom left corner.

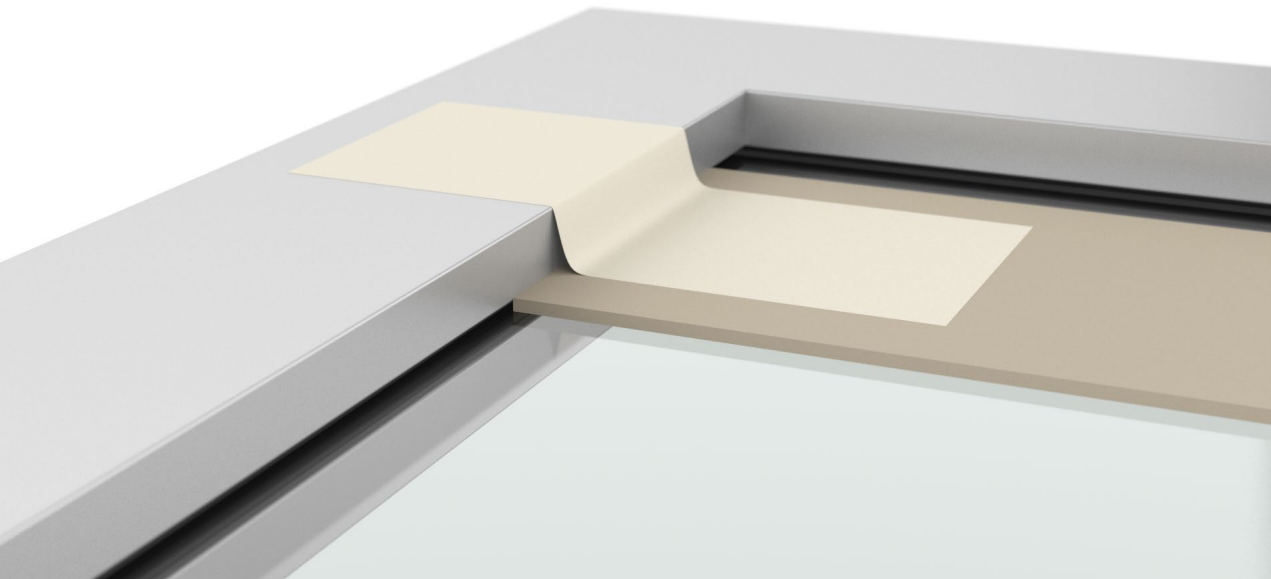

Use masking tape to keep the guide in place.



Place a second length guide

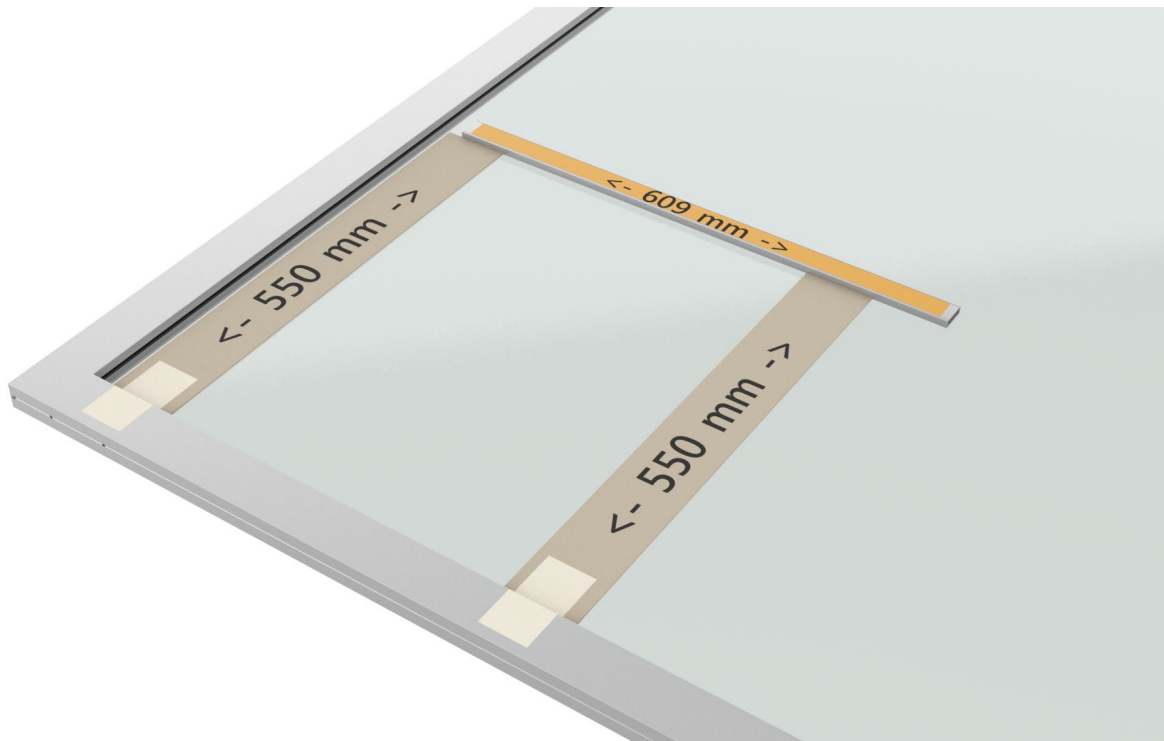

Take the first grid profile (603 mm)

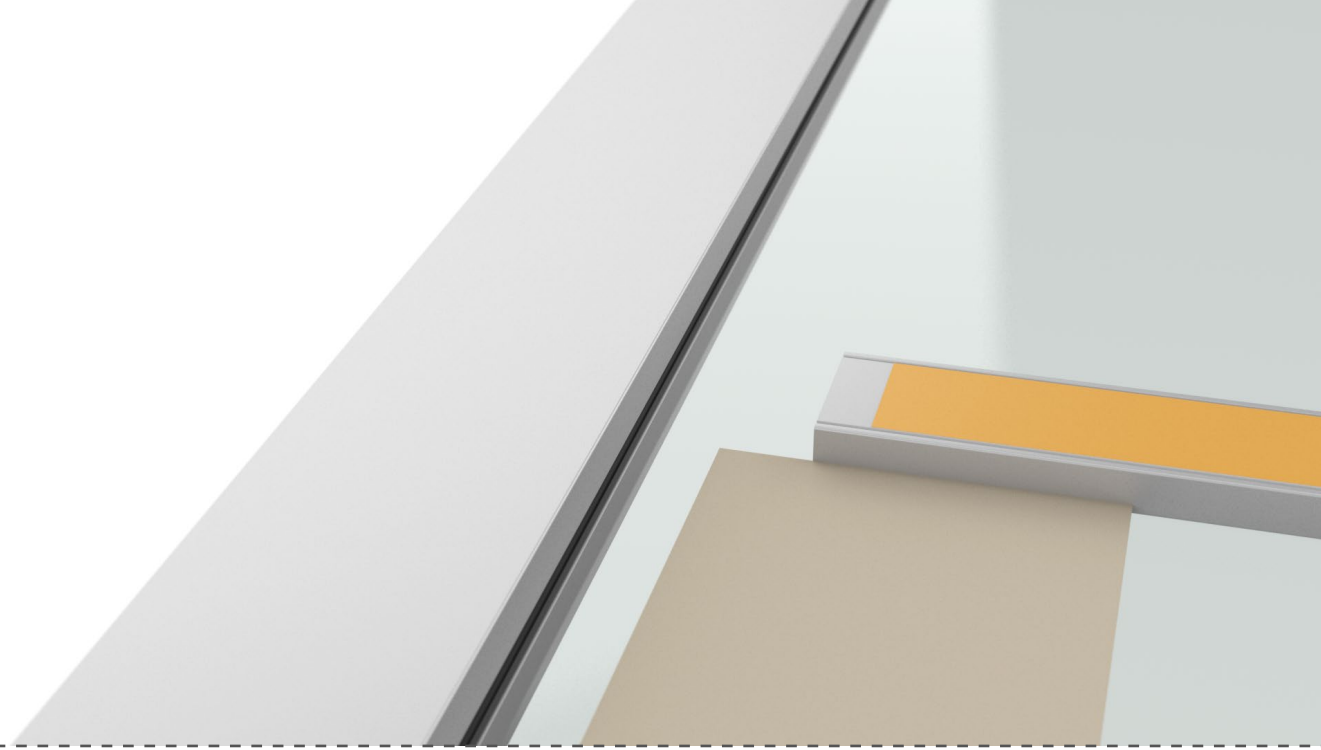

A small portion of tape should have been removed before the grid profile was cut. This will facilitate positioning.

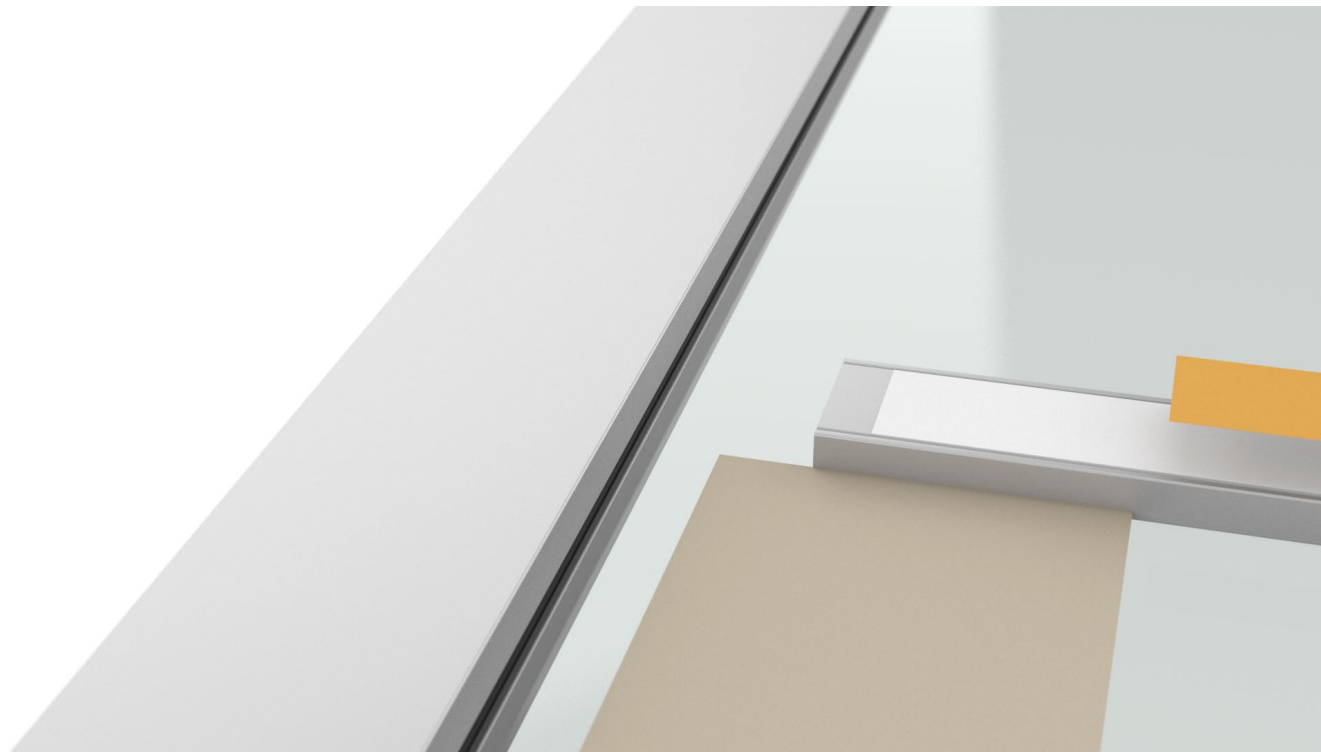

Remove the backing strip.

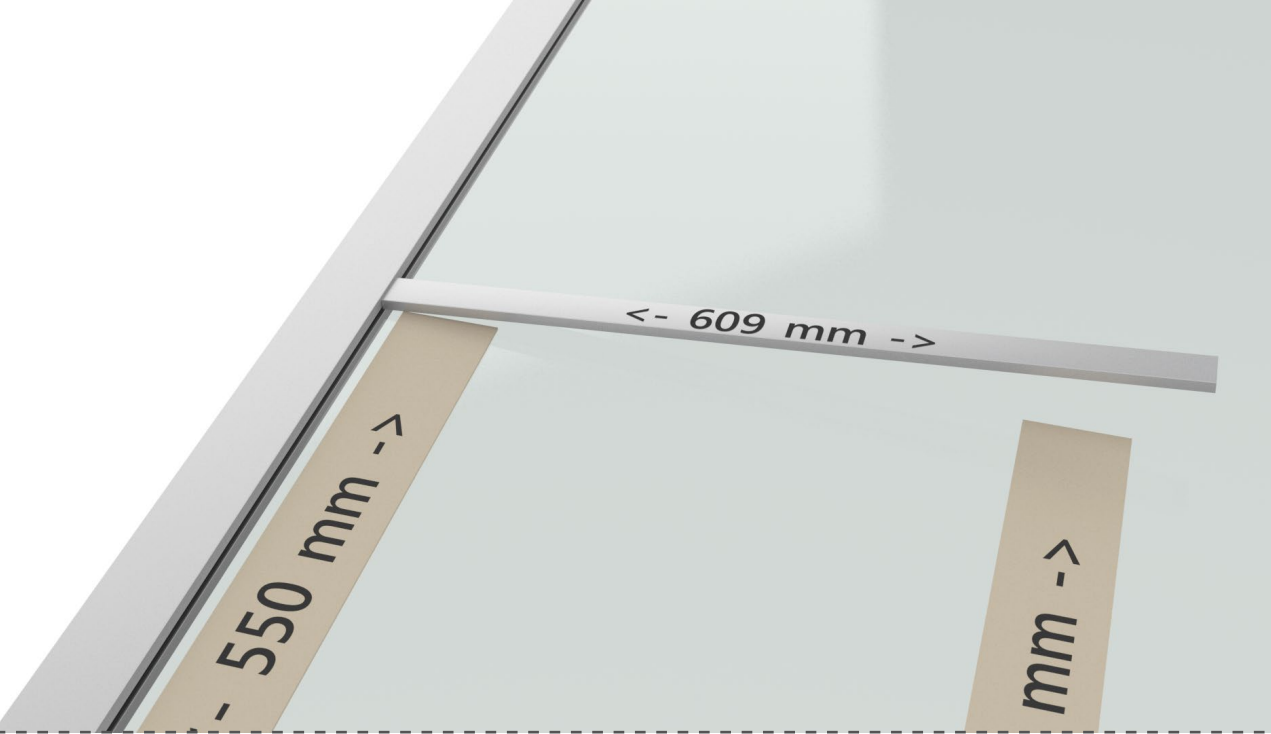

Use the length guides to position the grid profile onto the glass.

Make sure the grid profile is perfectly placed against the door frame and glass rubber.

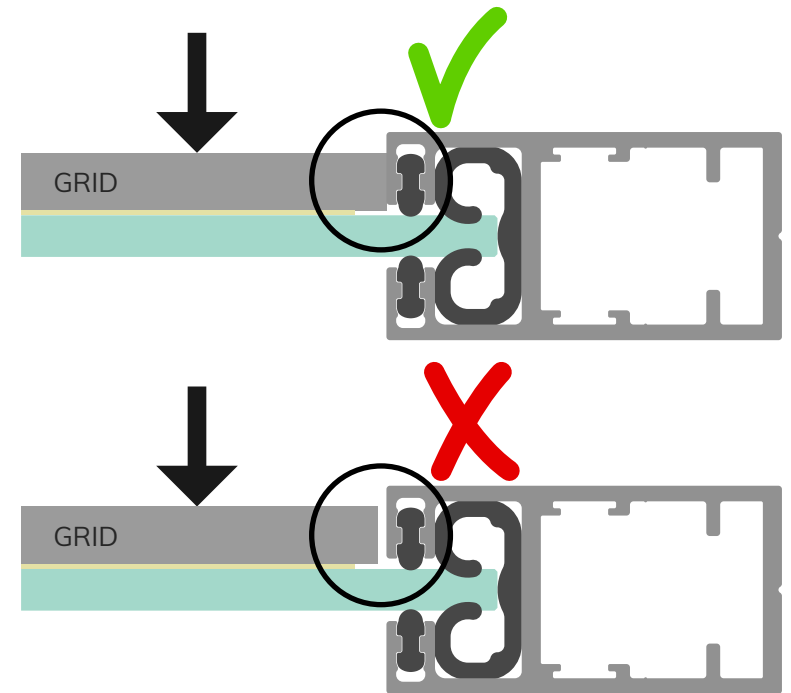
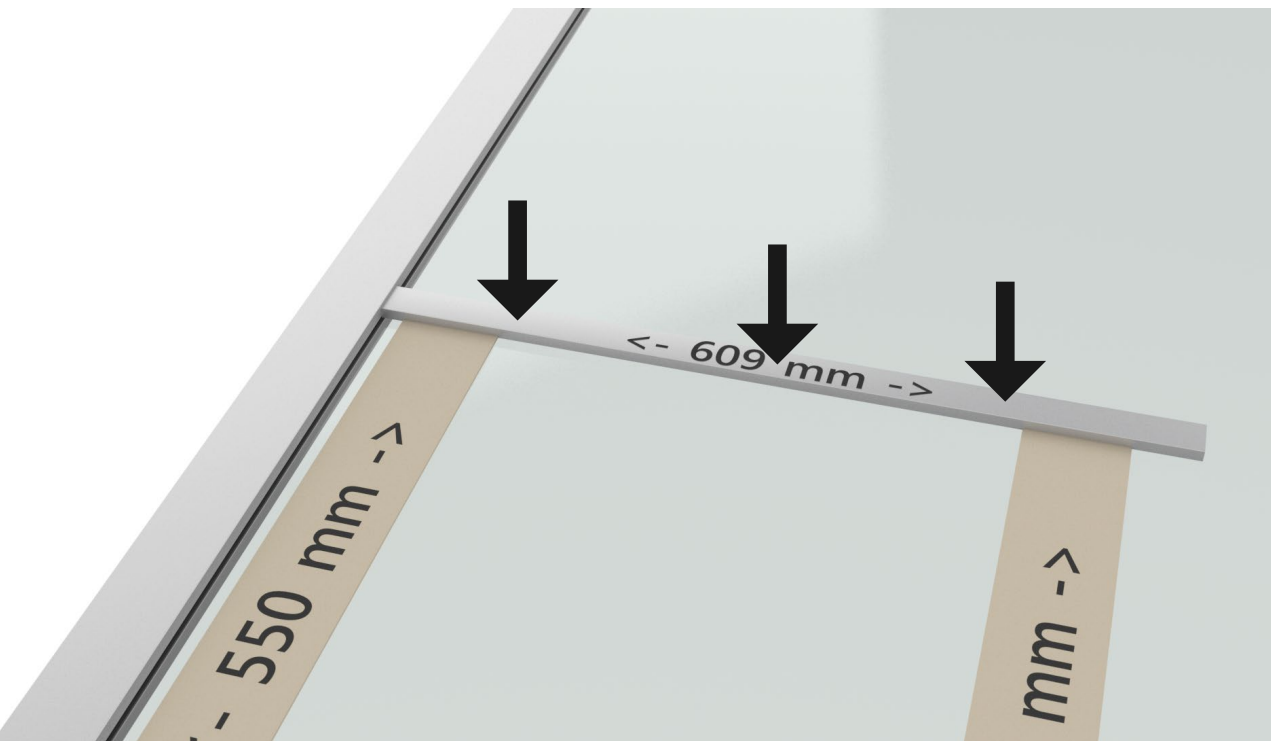

Press down firmly.

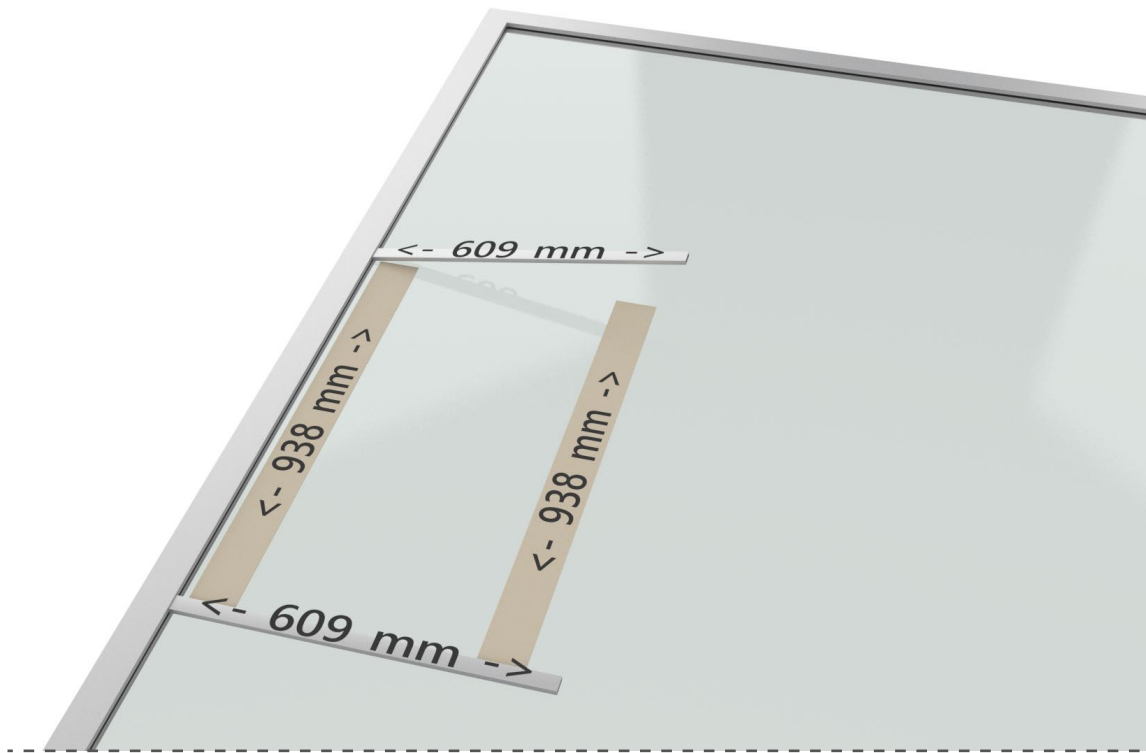

Repeat the same steps for the second grid profile.

Place length guides

Place profile

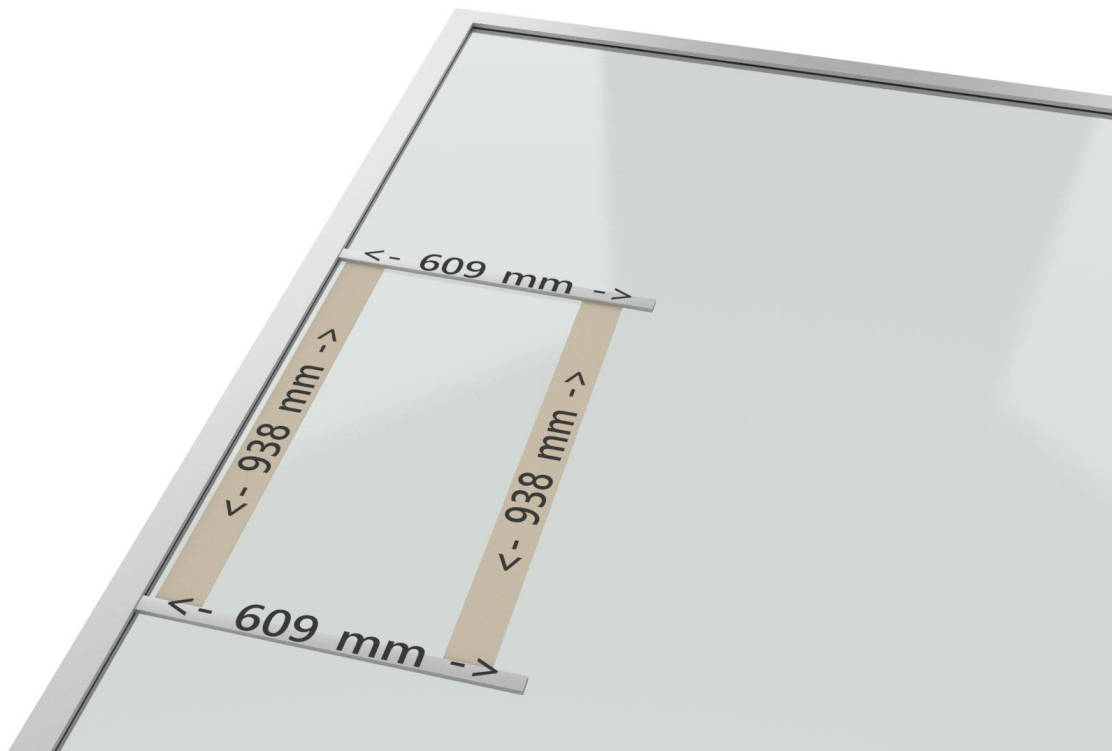

Press down firmly



Repeat the same steps for the first vertical grid profile.

Place length guides

Place profile

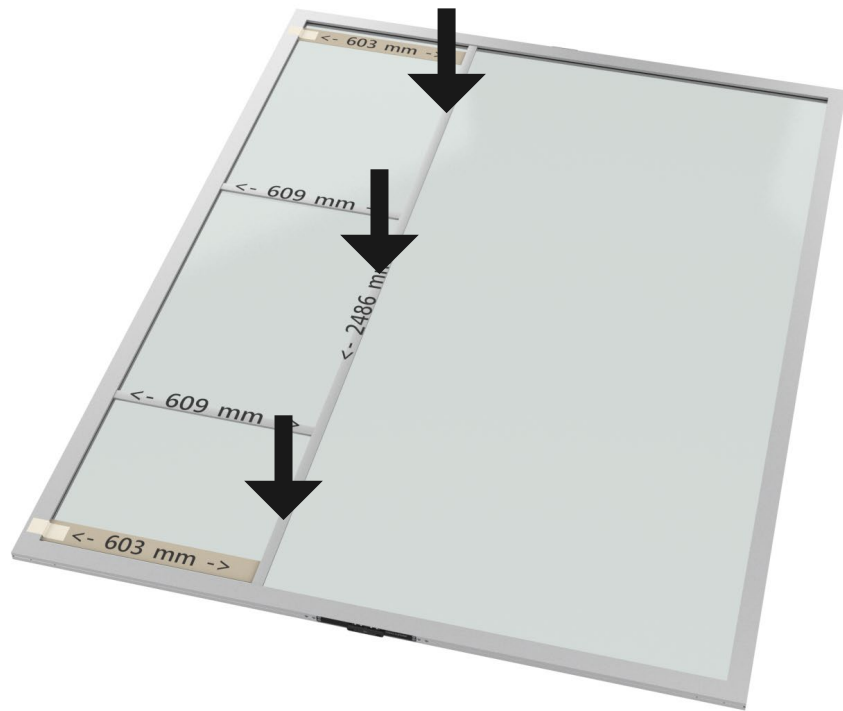

Press down firmly

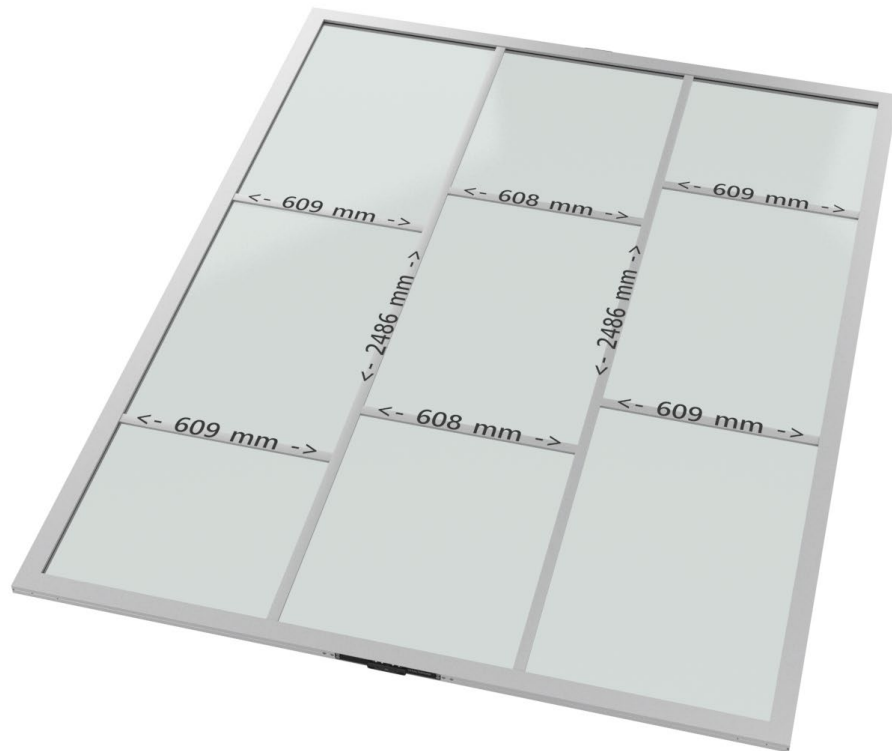

Repeat steps for all remaining grid profiles, using the correct length guides and grid profiles (according to your design).

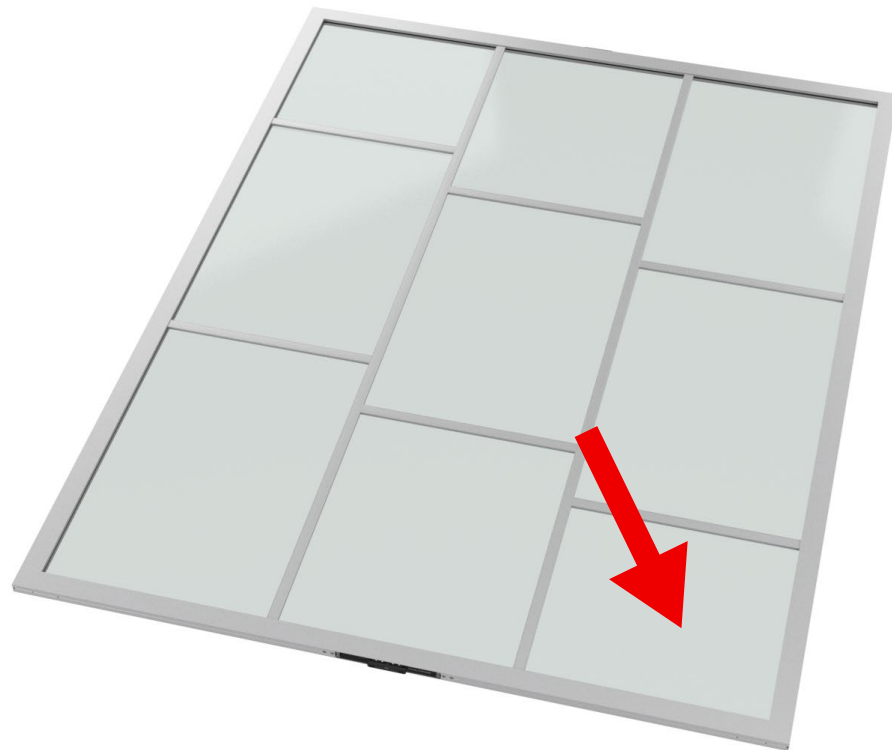

Flip over the door leaf and repeat all steps for the counterside.

For perfect alignment, start assembly in the same corner as the first side.

For further instructions on how to install
the fully assembled door in your doorway,
please refer to the DOOR INSTALLATION MANUAL