

PLAN

Not to Scale

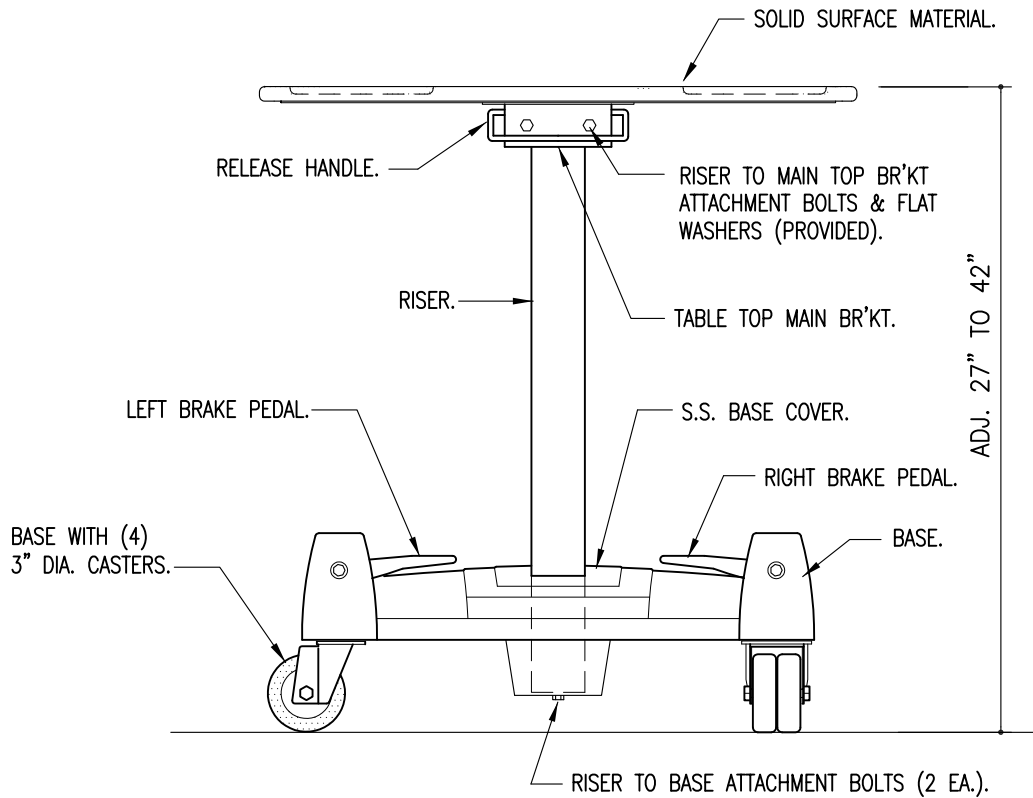

ELEVATION

Not to Scale

This drawing is the property of Chaparral 1 Inc. and is loaned subject to the condition that it is not to be copied, reproduced or distributed either whole or in part and is not to be used directly or indirectly excepting under the supervision of Chaparral 1 Inc.. Nor may it be used in any way that is detrimental to the interests of Chaparral 1 Inc.

Approximate weight: 80 lbs  
Approximate Crated weight: 215 lbs



P.O. Box 11368  
Portland, OR. 97211 - 0368  
Ph: (503) 285-9553  
Toll Free Ph: (888) 246-9348  
Fax: (503) 285-9526  
Toll Free Fax: (877) 246-9526  
www.chaparralfixtures.com

Model UN-ADS  
Adjustable Draw Stand

Date:  
7-19-12

Sheet  
1 of 1