

PHLEBOTOMY STATION LAYOUT
1 Station Layout

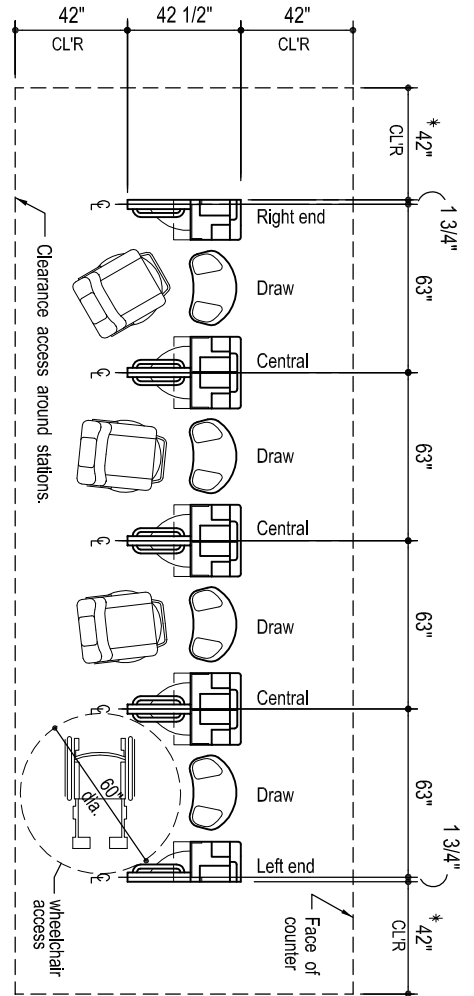

PHLEBOTOMY STATION LAYOUT
4 Station Layout

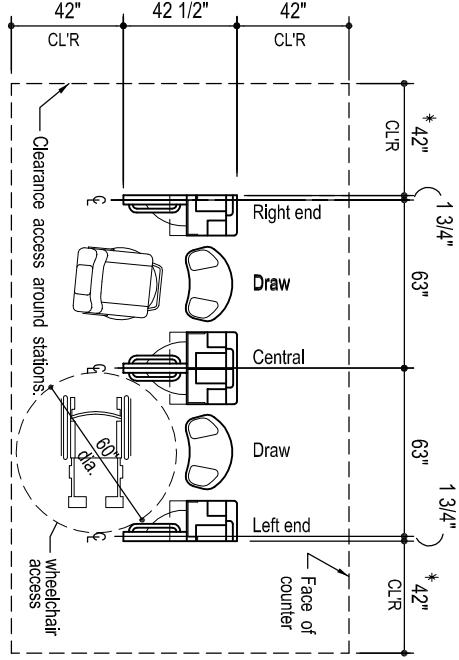

PHLEBOTOMY STATION LAYOUT
2 Station Layout

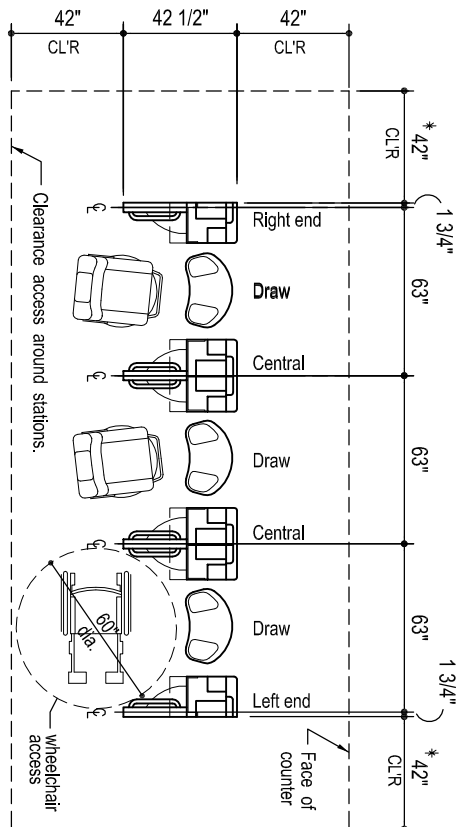

PHLEBOTOMY STATION LAYOUT
3 Station Layout

This drawing is the property of Chaparral 1 Inc. and is loaned subject to the condition that it is not to be copied, reproduced or distributed either whole or in part and is not to be used directly or indirectly excepting under the supervision of Chaparral 1 Inc.. Nor may it be used in any way that is detrimental to the interests of Chaparral 1 Inc.



P.O. Box 11368
 Portland, OR. 97211 - 0368
 Ph: (503) 285-9553
 Toll Free Ph: (888) 246-9348
 Fax: (503) 285-9526
 Toll Free Fax: (877) 246-9526
 www.chaparralfixtures.com

Model M MIV
 Phlebotomy Station
 Typical Layouts

Date:
 7-6-15
 Sheet
 1