



CATALOGUE X1/X2





FRAMELESS IS MORE

 [www.xinnix.eu](http://www.xinnix.eu)

 @xinnixdoorsystems

 xinnix\_door\_systems

 Xinnix Door Systems

 Xinnix Door Systems

 xdoorsystems

**TECHNICAL INFORMATION**

Certificates	P06
Frame type	P10
Dimensions	P12
Construction sizes	P14
X1 profile	P18
X2 profile	P22
Technical information	P26
Wall finish	P31
Double doors	P32
Push & Go - unlock the double door	P34
Door finish	P37

**HARDWARE**

Hinges	P38
Locks	P48
Door closers	P62
Finishing profile	P66
Plinths	P68



# UNIVERSAL SYSTEMS

The X1 and X2 aluminium door systems allow you to install a door flush into the wall.  
The systems can be used in multiple wall types with different wall thicknesses and finishes.

---

Interior doors often have to meet a whole range of requirements.

Just think of public buildings, schools, retirement homes,...

The X2 system offers numerous solutions without having to compromise on aesthetics.  
Besides standard systems, our range also includes systems for: heavy, very high/wide, acoustic,  
smoke-resistant and fire-resistant doors.

<b>WIDTH DOOR LEAF</b> max. 1230 mm  max. 1069 mm	<b>HEIGHT DOOR LEAF</b> max. 3500 mm  max. 3001 mm	<b>WEIGHT</b> max. 200 kg 
--	---	---

Certificate: **EN 1191**: Resistance to repeated opening and closing - 200.000 cycles.

# CERTIFICATES



## ACOUSTIC DOORS

33 dB  
Higher on demand.

Doctor's practice,  
bedroom,...



## FIRE-RATED DOORS



EI<sub>1</sub>30  
EI<sub>2</sub>60



EI<sub>1</sub>30

Entry apartment,  
hotel door,  
archive,...



## SMOKE RESISTANCE

Sa - S200

Hospital,  
hotel,...

## BURGLAR RESISTANCE



## ACOUSTIC AND FIRE-RATED DOORS

Museum,  
concert building,...

## FIRE-RATED AND SMOKE RESISTANT DOORS

School,  
retirement homes,...



### EN 1191

Resistance to repeated opening and closing - 200.000 cycles.



### NBN EN ISO 10140-2: 2010 - 717-1: 2013

Acoustic testing with laboratory measurement of sound insulation completed.



### EN 1634-1:2008

European Standard fire resistance testing fulfilled.



### EN 13501-2:2016

Fire resistance and smoke control test requirements fulfilled.

Xinnix Door Systems has passed Gyproc® Saint-Gobain Group Anti-Cracking testing.











# FRAME TYPE

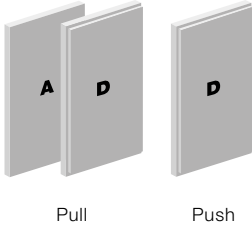
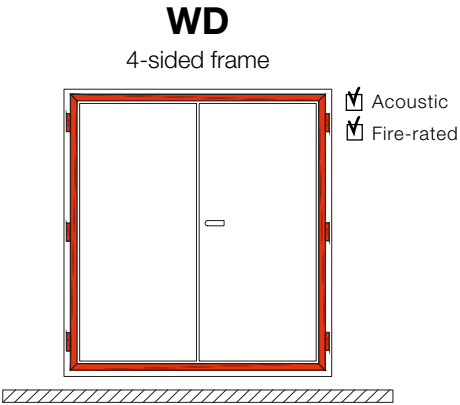
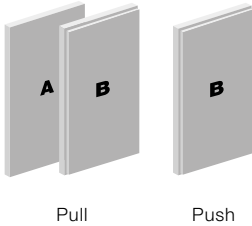
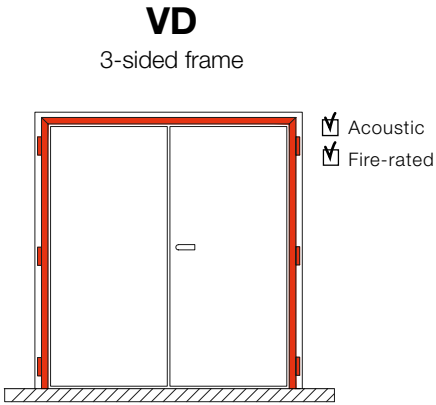
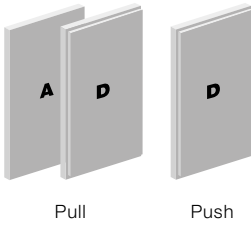
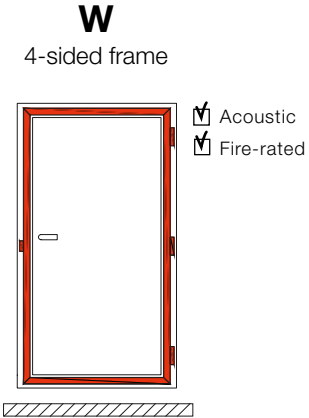
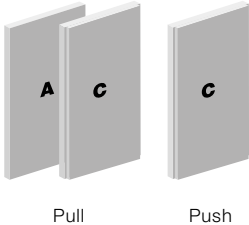
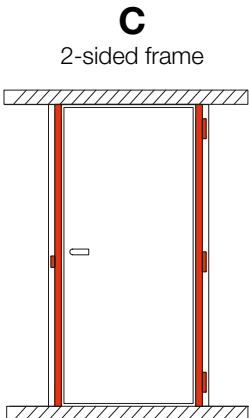
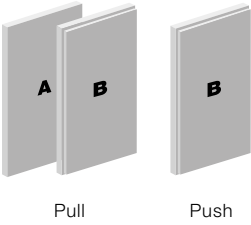
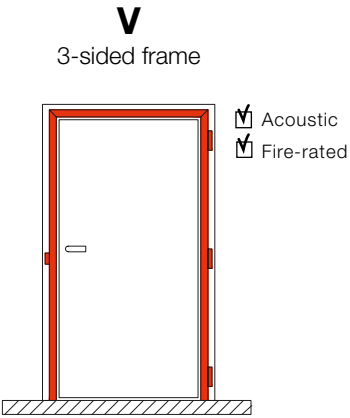

For more information, please view our milling plans.



# **DIMENSIONS**

## **Wp: width door leaf**

Systems in stock for door leaf widths: 630/680/710/726/730/780/810/826/830/880/910/930/980/1030 mm.  
Pick a width of your own choosing, maximum 1230 mm or 1069 mm for a fire-rated version.

## **Hp: height door leaf**

Systems in stock for door leaf heights: 1972/2015/2040/2115/2315/2410 mm.  
Pick a height of your own choosing, maximum 3500 mm or 3001 mm for a fire-rated version.

## **Vo: lower ventilation**

Systems in stock: 3 mm.  
You can change the lower ventilation when ordering a made to measure system (see drawing on the next page).

## **Vb: upper ventilation**

Systems in stock: 3 mm.  
You can change the upper ventilation when ordering a made to measure system (see drawing on the next page).

## **Vneg: ventilation under floor level**

Systems in stock: 0 mm.  
Use this ventilation for an installation below floor level (see drawing on the next page).

## **Hk: height handle on door**

Systems in stock: 1050 mm.  
You can change this dimension on special request.

## **Hk0: height handle floor level**

Systems in stock: 1053 mm.  
Depends on Hk and Vo.

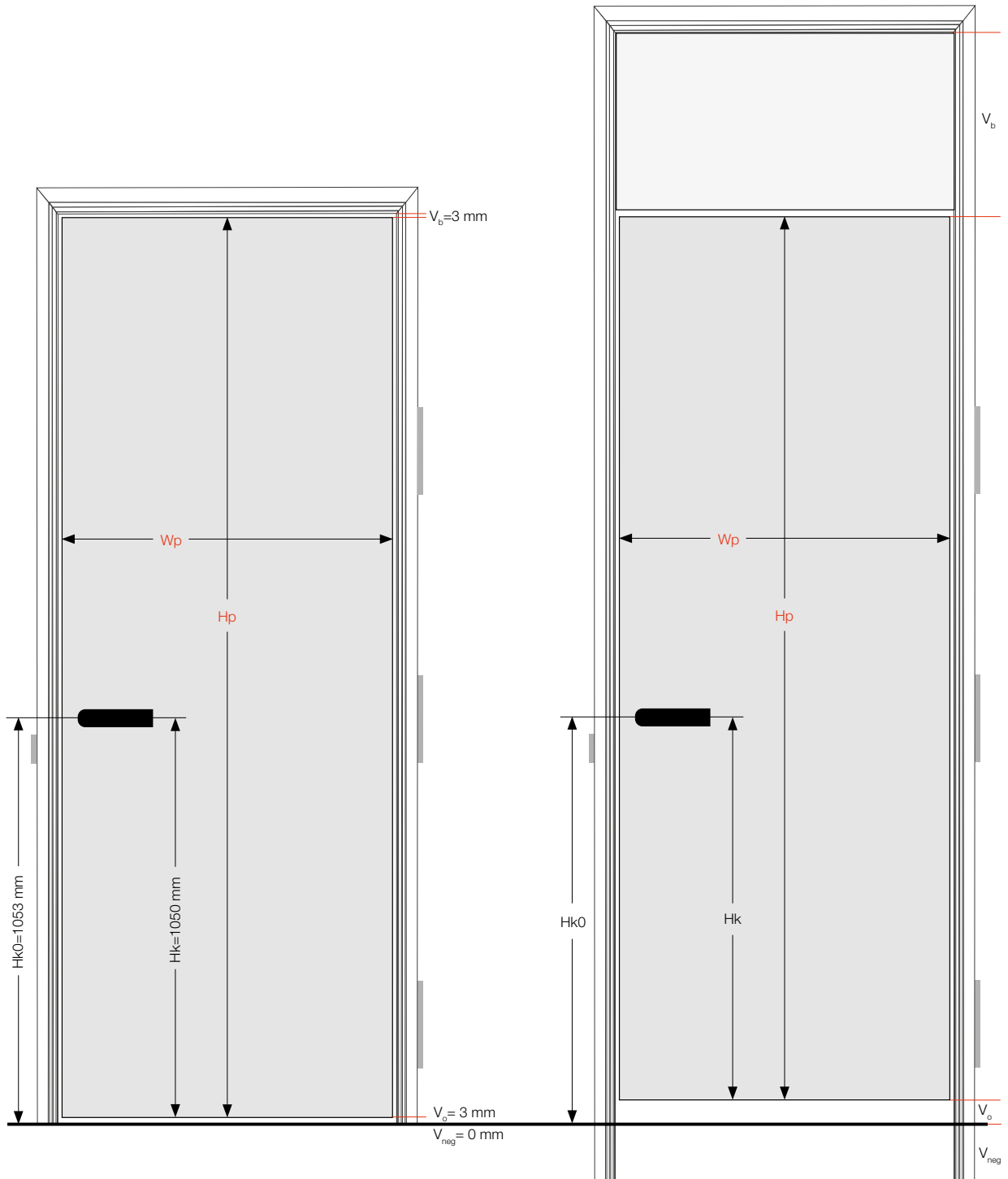

Stock items - standard dimensions

Made to measure - variables

# CONSTRUCTION SIZES

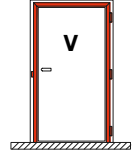
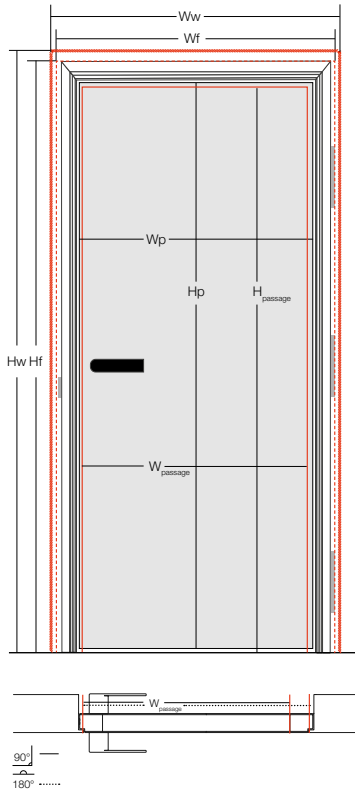

Height		A24	TE340
$H_p$	height door leaf	$H_w - 35$	$H_w - 35$
$H_f$	height frame	$H_p + 26,5$	$H_p + 26,5$
$H_w$	height construction	$H_p + 35$	$H_p + 35$
$H_{passage}$	height passage	$H_p - 10$	$H_p - 10$

Width		A24	TE340
$W_p$	width door leaf	$W_w - 70$	$W_w - 85$
$W_f$	width frame	$W_p + 55$	$W_p + 70$
$W_w$	width construction	$W_p + 70$	$W_p + 85$
$W_{passage}$	width passage*	$W_p - 20$	$W_p - 20$

\* opening 180°,  
opening 90° without handle  $W_{passage}$  - door leaf thickness

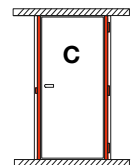
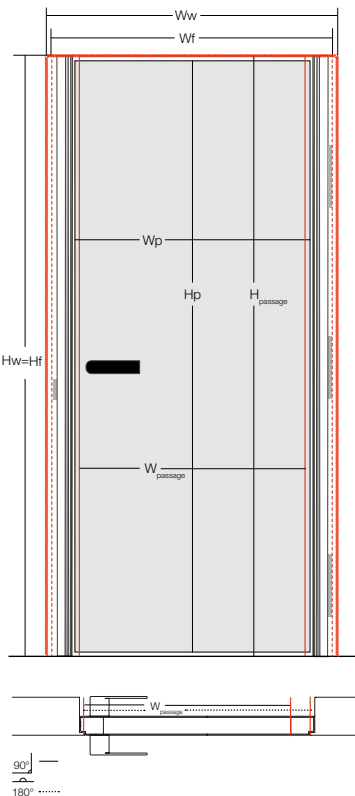

Height		A24	TE340
$H_p$	height door leaf	$H_w - 6$	$H_w - 6$
$H_f$	height frame	$H_p + 6$	$H_p + 6$
$H_w$	height construction	$H_p + 6$	$H_p + 6$
$H_{passage}$	height passage	$H_p + 6$	$H_p + 6$

Width		A24	TE340
$W_p$	width door leaf	$W_w - 70$	$W_w - 85$
$W_f$	width frame	$W_p + 55$	$W_p + 70$
$W_w$	width construction	$W_p + 70$	$W_p + 85$
$W_{passage}$	width passage*	$W_p - 20$	$W_p - 20$

\* opening 180°,  
opening 90° without handle  $W_{passage}$  - door leaf thickness



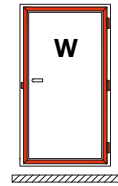
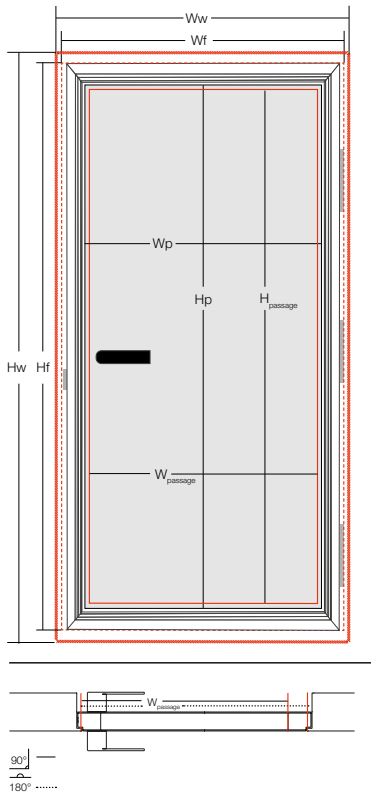

Height		A24	TE340
Hp	height door leaf	Hw - 70	Hw - 70
Hf	height frame	Hp + 53	Hp + 53
Hw	height construction	Hp + 70	Hp + 70
H <sub>passage</sub>	height passage	Hp - 20	Hp - 20

Width		A24	TE340
Wp	width door leaf	Ww - 70	Ww - 85
Wf	width frame	Wp + 55	Wp + 70
Ww	width construction	Wp + 70	Wp + 85
W <sub>passage</sub>	width passage*	Wp - 20	Wp - 20

\* opening 180°,  
opening 90° without handle W<sub>passage</sub> - door leaf thickness

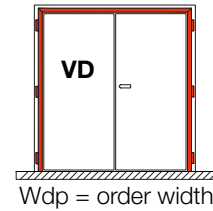
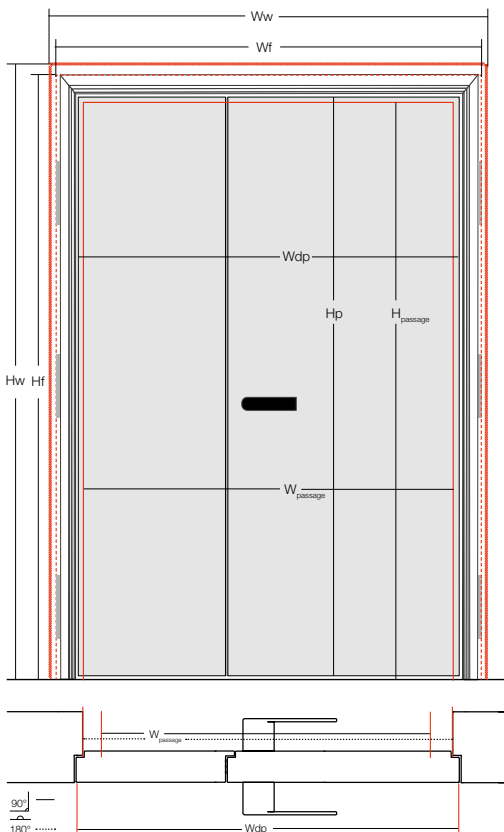

Height		A24	TE340
Hp	height door leaf	Hw - 35	Hw - 35
Hf	height frame	Hp + 26,5	Hp + 26,5
Hw	height construction	Hp + 35	Hp + 35
H <sub>passage</sub>	height passage	Hp - 10	Hp - 10

Width		A24	TE340
Wdp	width double door leaf	Ww - 70	Ww - 85
Wf	width frame	Wdp + 57	Wp + 70
Ww	width construction	Wdp + 70	Wp + 85
W <sub>passage</sub>	width passage*	Wdp - 20	Wp - 20

\* opening 180°,  
opening 90° without handle W<sub>passage</sub> - door leaf thickness



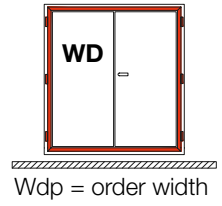
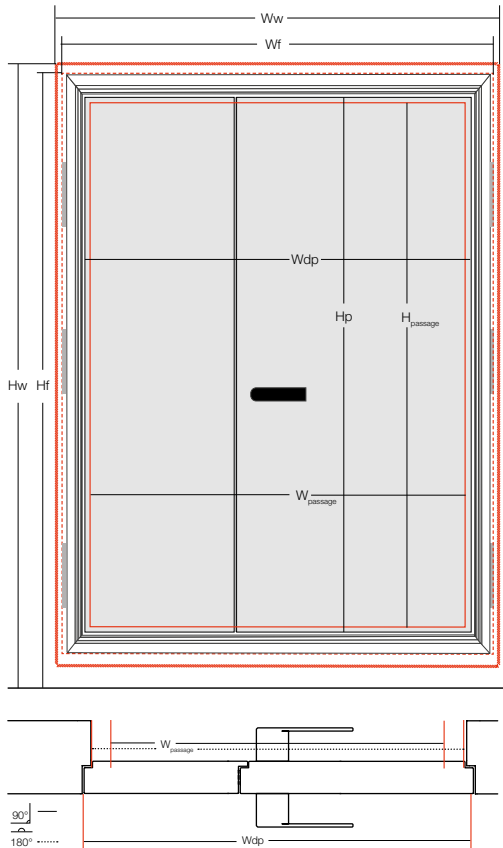

Height		A24	TE340	
Hp	height door leaf	Hw - 70	Hw - 70	
Hf	height frame	Hp + 53	Hp + 53	---
Hw	height construction	Hp + 70	Hp + 70	////
H <sub>passage</sub>	height passage	Hp - 20	Hp - 20	---

Width		A24	TE340	
Wdp	width double door leaf	Ww - 70	Ww - 85	
Wf	width frame	Wdp + 57	Wdp + 70	---
Ww	width construction	Wdp + 70	Wdp + 85	////
W <sub>passage</sub>	width passage*	Wdp - 20	Wdp - 20	---

\*opening of 180°,  
 opening 90° without handle W<sub>passage</sub> - door leaf thickness



# X1

## UNIVERSAL FRAME

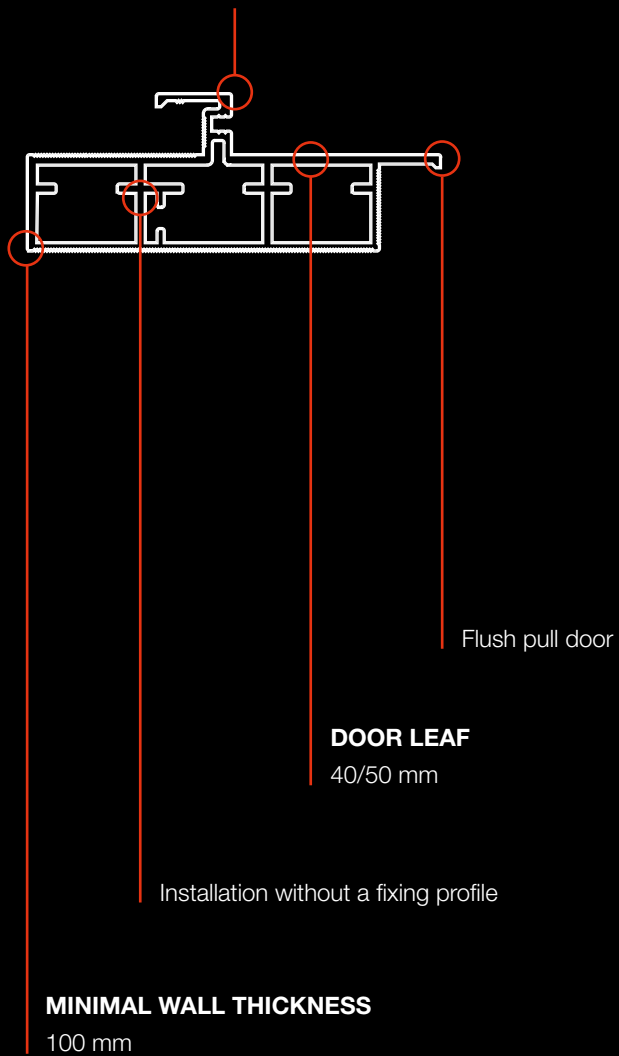

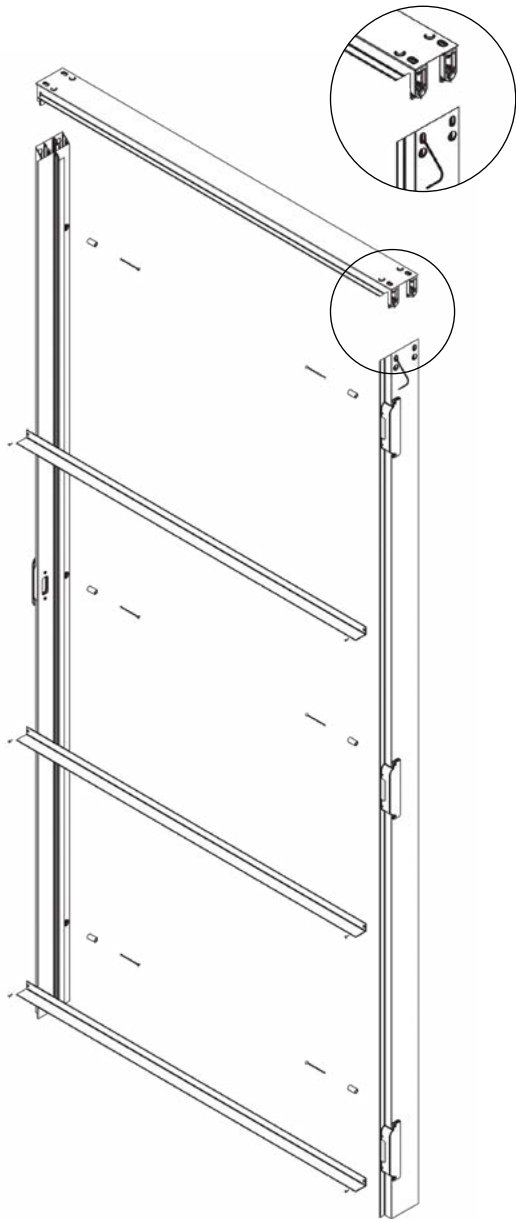

**FRAME TYPE V - 45° FRAME**



INSTALLATION VIDEO

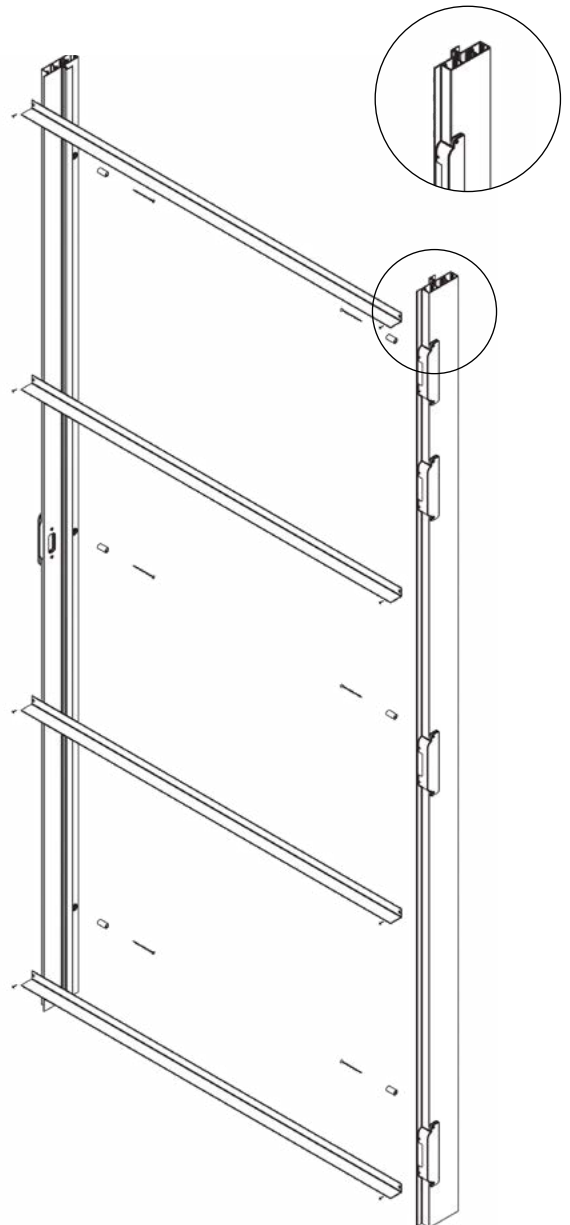

**FRAME TYPE C - 90° FRAME**



INSTALLATION VIDEO

# POSITIONS X1

EU LEFT - CLOCKWISE



INSTALLATION **PULL** EU LEFT

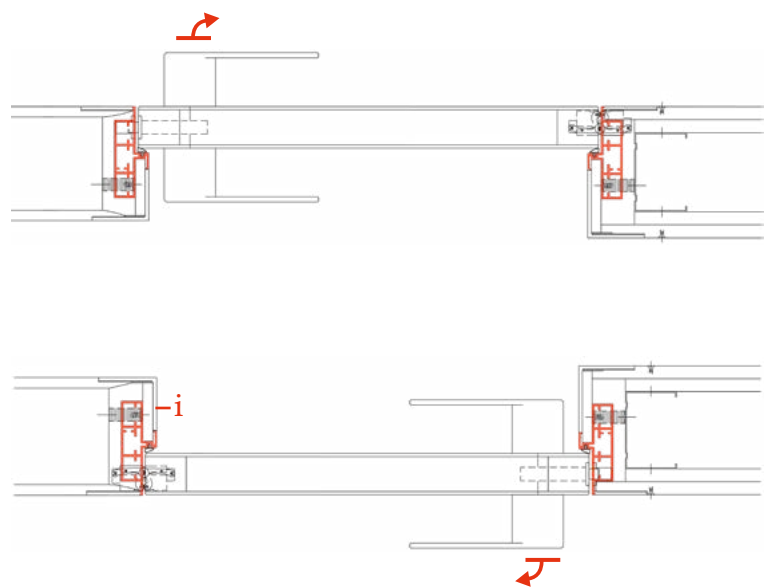

**i** The finishing profile XA-FIN allows you to easily finish the walls regardless of the wall thickness, more information on page 66.

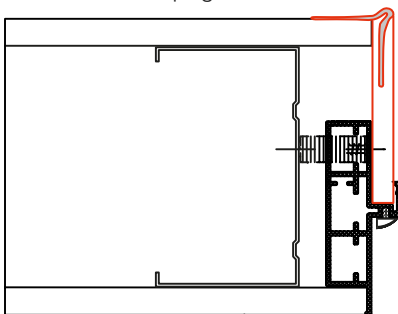

# POSITIONS X1

EU RIGHT - COUNTER CLOCKWISE



INSTALLATION **PULL** EU RIGHT

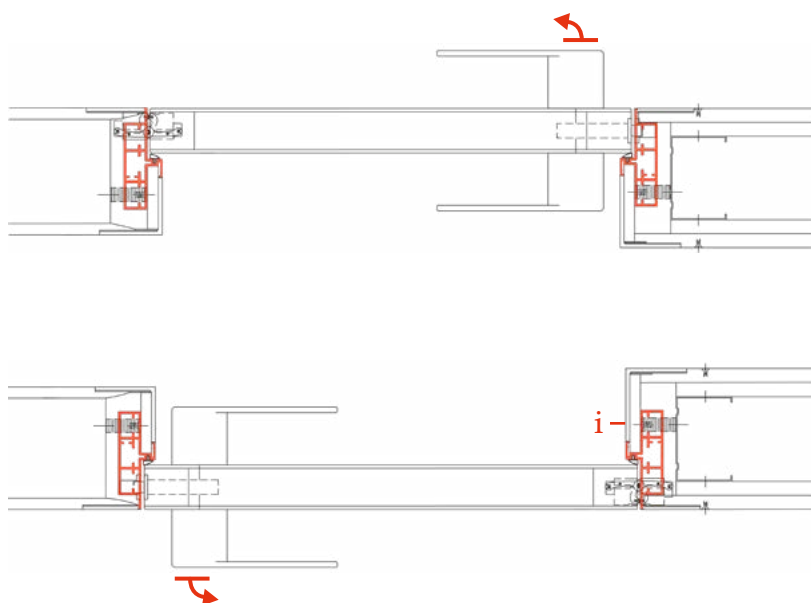

**i** The finishing profile XA-FIN allows you to easily finish the walls regardless of the wall thickness, more information on page 66.

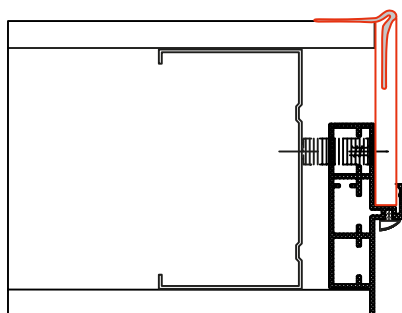

# X2

## UNIVERSAL FRAME

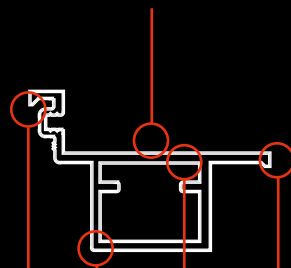

Flush pull or push door

### **DOOR LEAF**

40\*/45\*/50/55/60 mm

\*only flush pull version

Installation with fixing profile according to the Xinnix guidelines, page 26

### **MINIMAL WALL THICKNESS**

From 75 mm

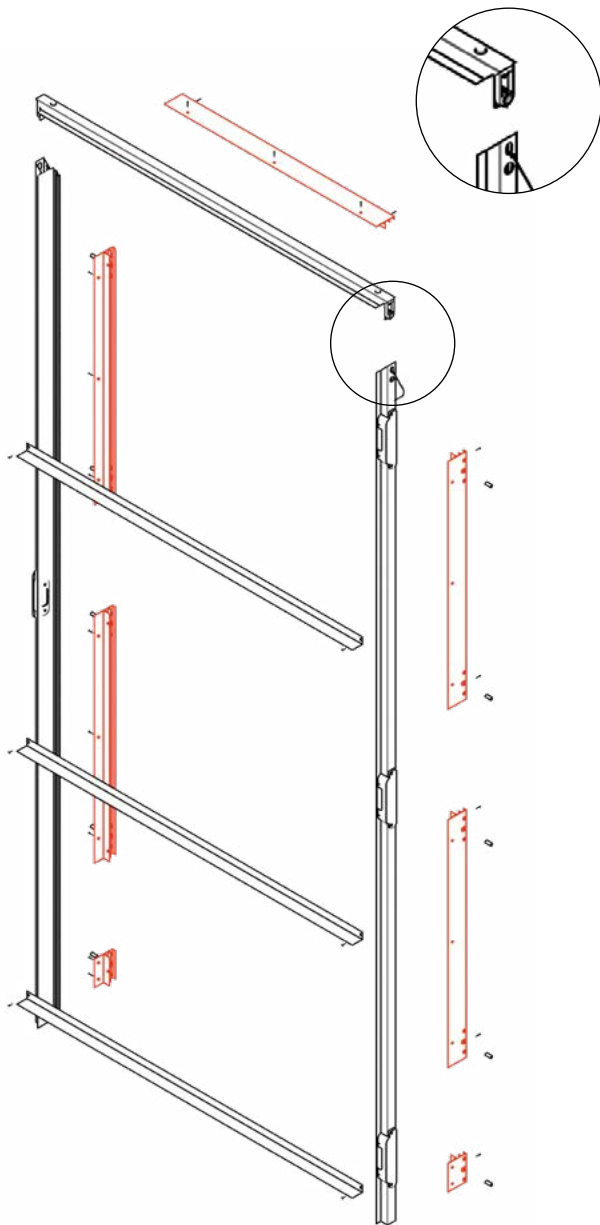

  
Fire-rated on demand

**FRAME TYPE V - 45° FRAME**



INSTALLATION VIDEO

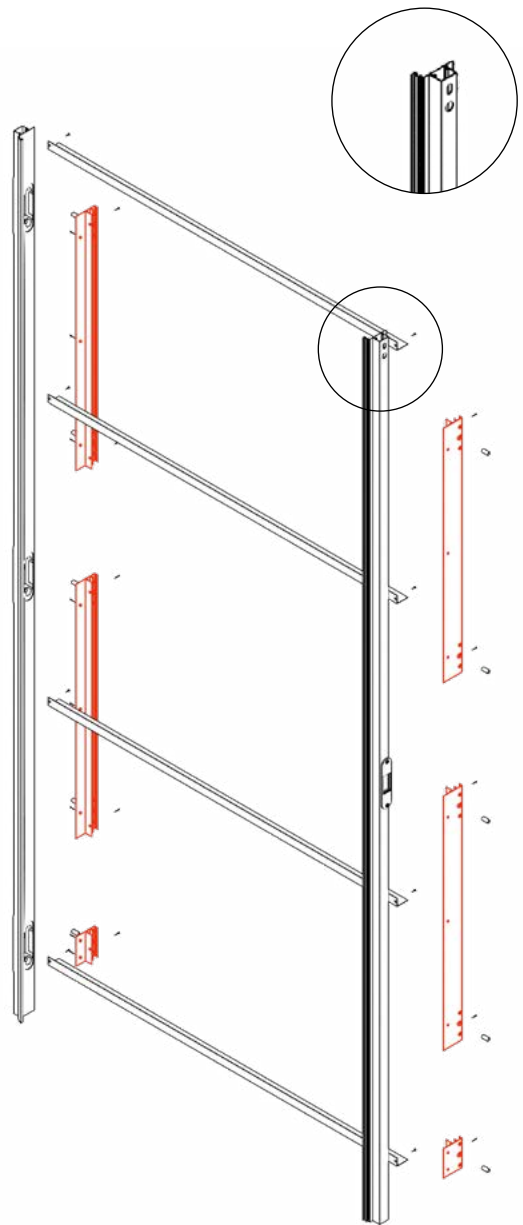

**FRAME TYPE C - 90° FRAME**



INSTALLATION VIDEO

# POSITIONS X2

LEFT - CLOCKWISE



Visually an uneven door height for a door with a 3-sided frame.

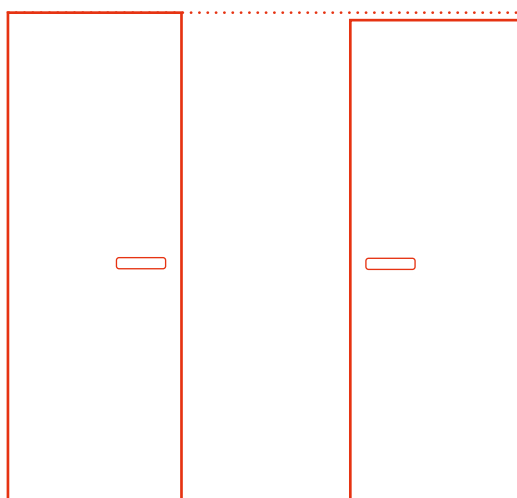

INSTALLATION **PULL** EU LEFT



INSTALLATION **PUSH** EU LEFT





# POSITIONS X2

RIGHT - COUNTER CLOCKWISE



Visually an uneven door height for a door with a 3-sided frame.

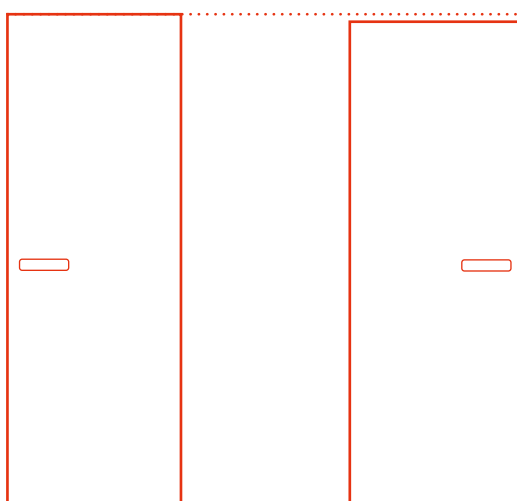

INSTALLATION **PULL** EU RIGHT



INSTALLATION **PUSH** EU RIGHT



# TECHNICAL INFORMATION

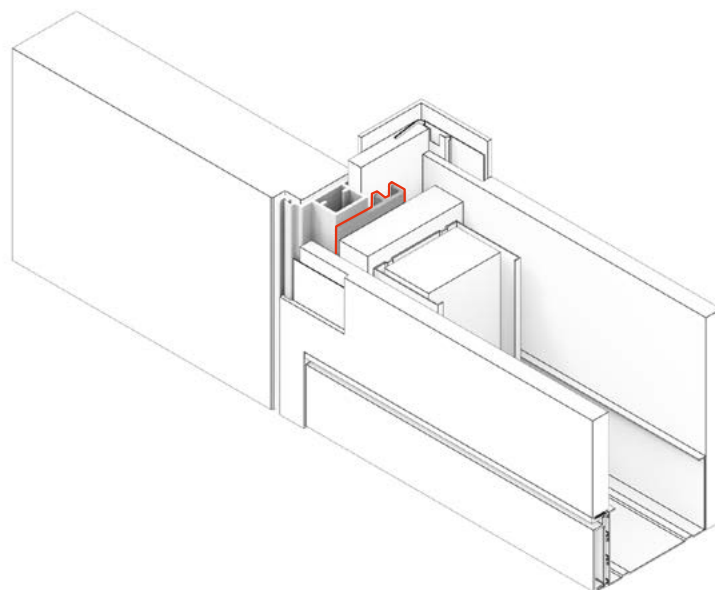

With the use of a fixing profile, you install the X2 system in the wall. This profile is different depending on the situation.

This profile is not required when installing the X1 system.

**FU:** universal fixing profile for a frame with 3 hinges.

**FUL:** universal fixing profile for frames with more than 3 hinges, heavy doors and fire-rated versions.

## FIXING BLOCK PROFILE

**FB50:** universal fixing block profile for installation against already finished walls, the door is flush on both sides, no further finishing needed and only available in combination with the X240. In this situation, the minimal finished wall thickness is 50 mm.

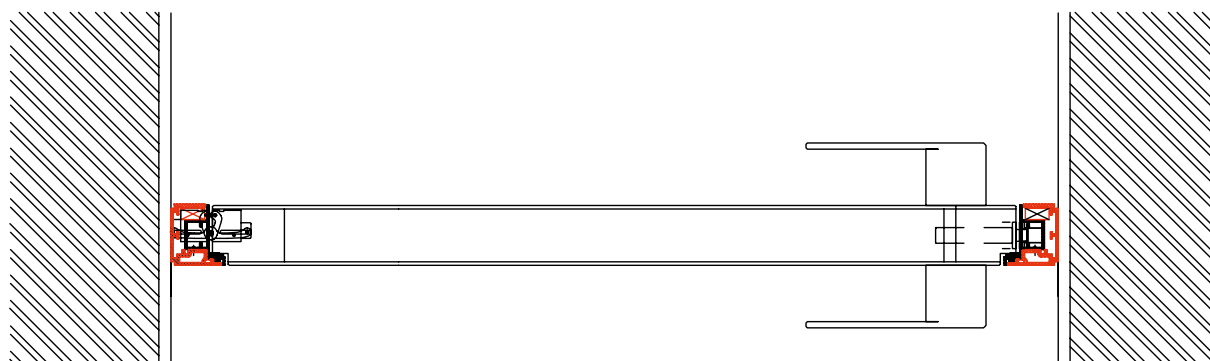





# TECHNICAL INFORMATION

X1

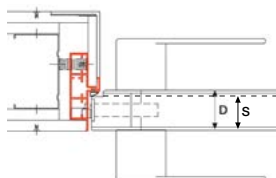

Door leaf: pull **40 mm (S)**

Door leaf: pull **50 mm (D)**

Minimal finished wall thickness: **100 mm**

Frame color:

X240

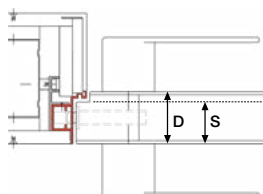

🔥 X240

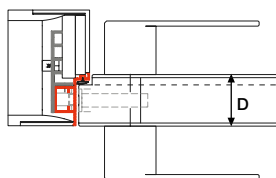

Door leaf: pull **40 mm (S)**

🔥 Door leaf: pull/push **50 mm (D)**

Minimal finished wall thickness: **75 mm (FU)**

Minimal finished wall thickness: **100 mm (FUL)**

Frame color:

X245

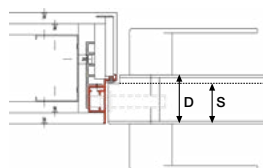

🔥 X245

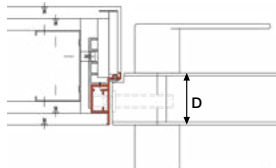

Door leaf: pull **44-45 mm (S)**

🔥 Door leaf: pull/push **55 mm (D)**

Minimal finished wall thickness: **105 mm (FU)**

Minimal finished wall thickness: **125 mm (FUL)**

Frame color:

X250

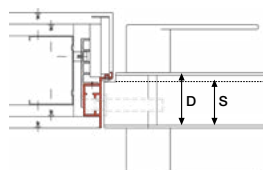

🔥 X250

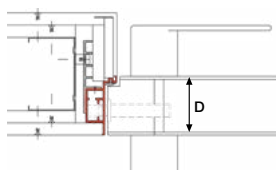

Door leaf: pull **50 mm (S)**

🔥 Door leaf: pull/push **60 mm (D)**

Minimal finished wall thickness: **110 mm (FU)**

Minimal finished wall thickness: **125 mm (FUL)**

Frame color:   \*

\*possible at minimum order quantity



# WALL FINISH

## FRAME WITH STANDARD HARDWARE

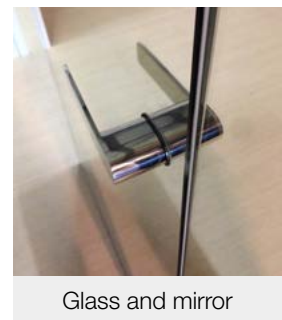
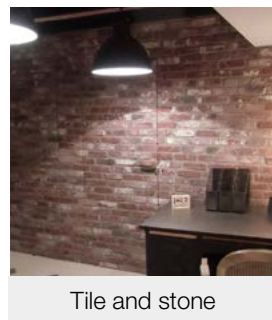
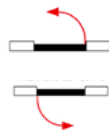
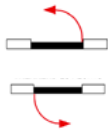
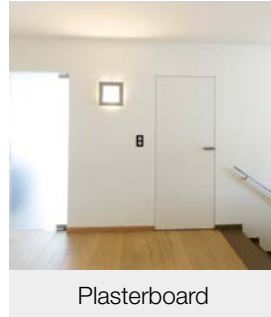

## FRAME WITH ALTERED HARDWARE

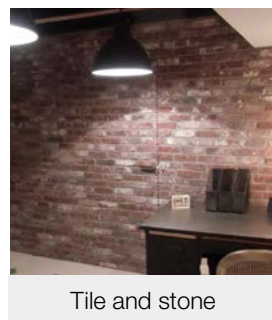

We offer the possibility to add a maximum of 6 mm finish to your wall and flush pull door. More information on page 40 (hinges for wallcoverings).

# DOUBLE DOORS

Optional:  Fire-rated

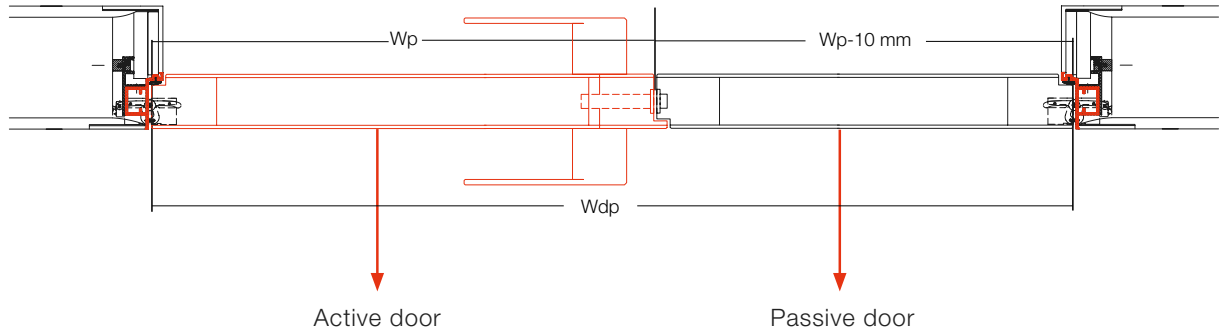

- 🔥 **DLA: double active left**
- 🔥 **DRA: double active right**
- DK: double closet door

**DRP: double passive right**

INSTALLATION **PULL** EU LEFT

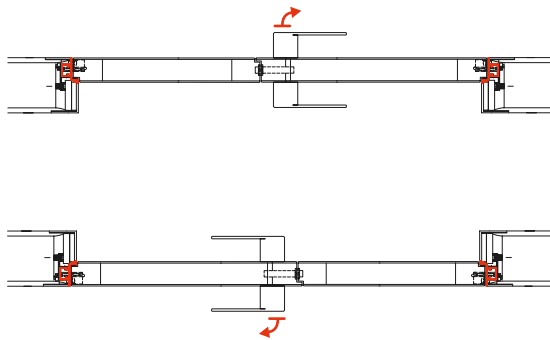

INSTALLATION **PULL** EU RIGHT

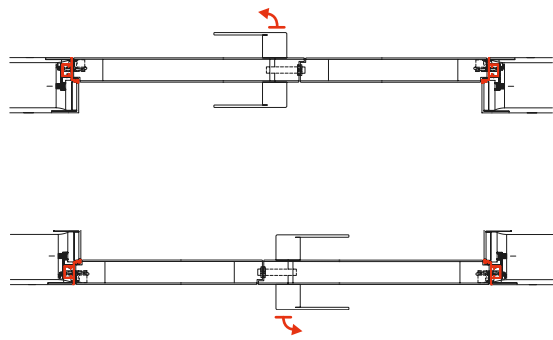

INSTALLATION **PUSH** EU LEFT

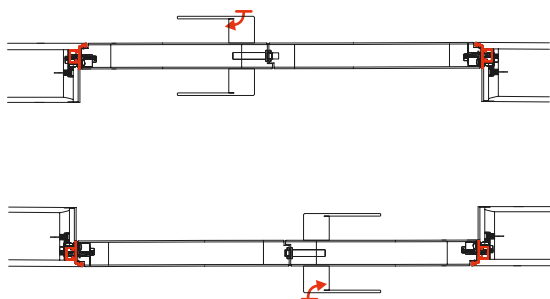

INSTALLATION **PUSH** EU RIGHT

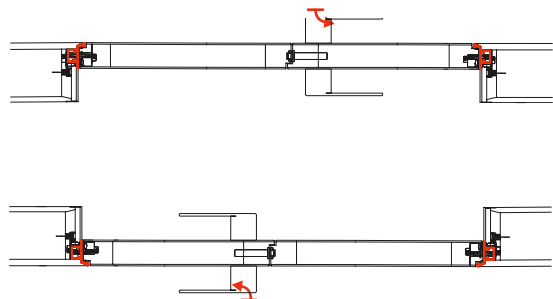



**SYMMETRICAL**

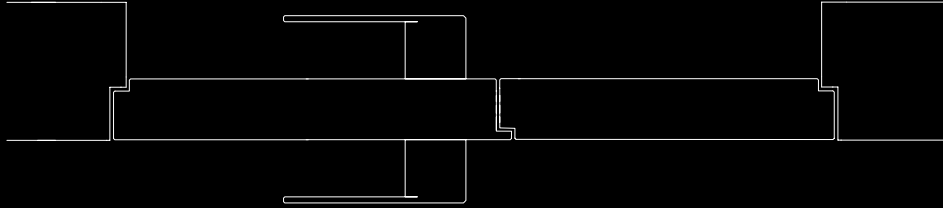

**ASYMMETRICAL**

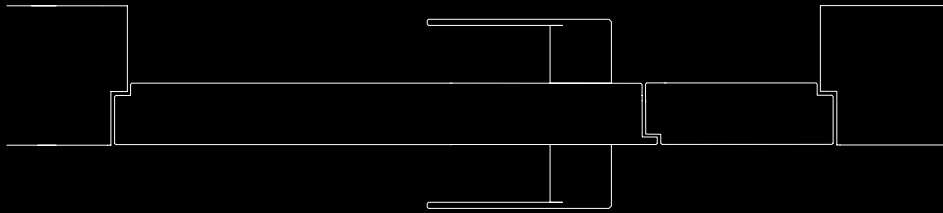

**CLOSET DOOR**

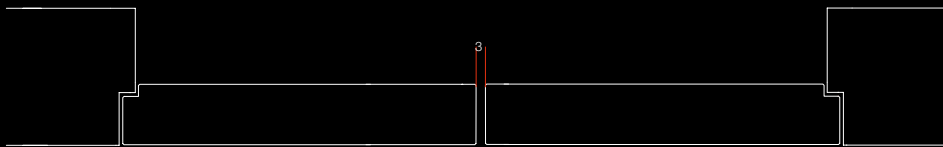

# PUSH & GO

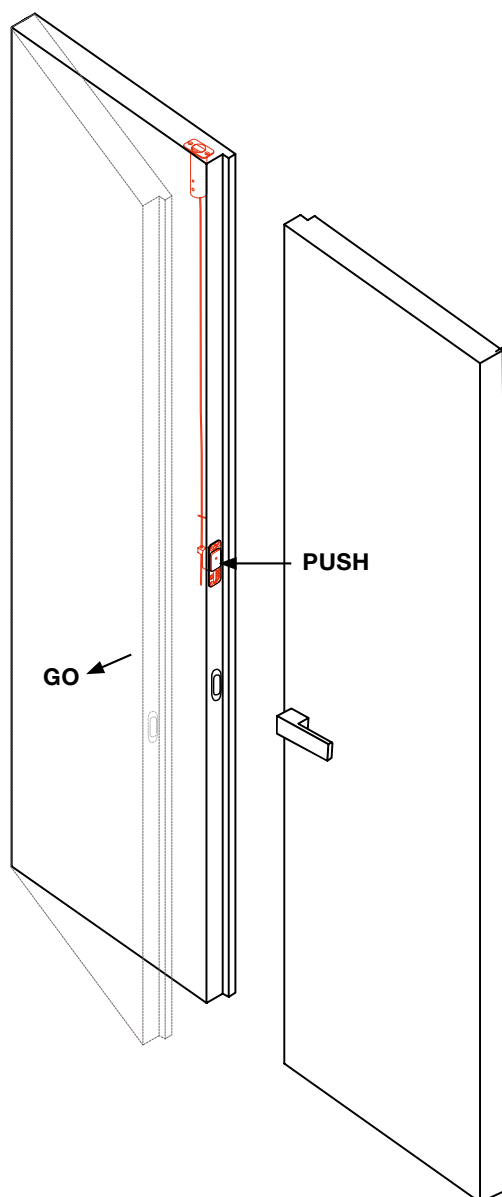

## PG4100



Push & Go is a magnetic system to quickly and easily unlock the fixed door leaf of a double door. With one push on the button, the fixed panel is free and you create a completely free passage. The magnetic closure ensures fast and effortless locking.

Locking is as easy as opening. You close the door and the fixed part is fixed again. Ideal for taller double doors. A slim, elegant finish: usable in all door thicknesses. Because the lock is integrated in the upper rail, the floor stays completely free.





# DOOR FINISH

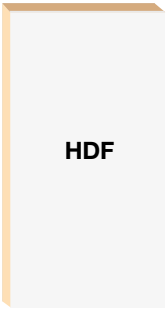

Our doors have a white HDF layer.

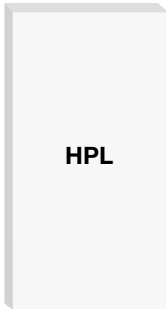

Ivory Oak



Nat Oak



Smokwain



Chocloak



Raven Oak

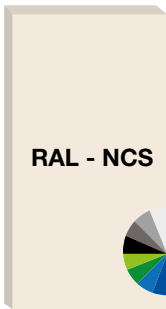

We offer the above options in terms of door finishes. Is the finish you need not among these options? Contact us for a customised finish.

# HINGES



**Load capacity**  
60 kg/3 hinges  
80 kg/4 hinges

✓ Fire-resistant tested

## A24

110 x 24 x 27 mm

Easy installation (1 person)

Reversible left-right

Opening angle 180°

Consealed and independent 3D – adjustment  
(side +- 1 mm, height +- 2 mm, compression +- 1 mm)



A24.0 A24.1 A24.2

X1	X240	X245	X250
X	X	X	X

### CLASSIFICATION KEY

2	7	3	1	1	*	0	10
---	---	---	---	---	---	---	----

\*depending on the finish

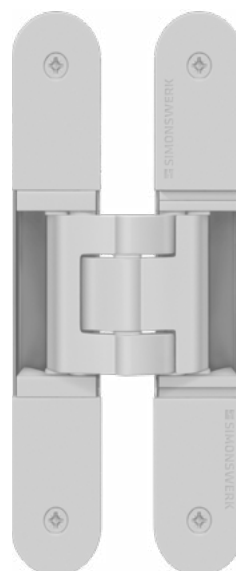

**Load capacity**  
80 kg/2 hinges

✓ Fire-resistant tested

## TECTUS TE340 3D

160 x 28 x 33,5 mm

Easy installation (1 person)

Reversible left-right

Opening angle 180°

Consealed and independent 3D – adjustment  
(side +- 3 mm, height +-3 mm, compression +- 1 mm)



TE340.0 TE340.1 TE340.2

X1	X240	X245	X250
X	X	X	X

### CLASSIFICATION KEY

3	7	4	1	1	*	0	11
---	---	---	---	---	---	---	----

\*depending on the finish

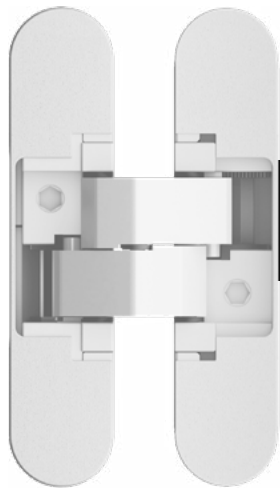

**Load capacity**

60 kg/3 hinges  
80 kg/4 hinges

✓ Fire-resistant tested

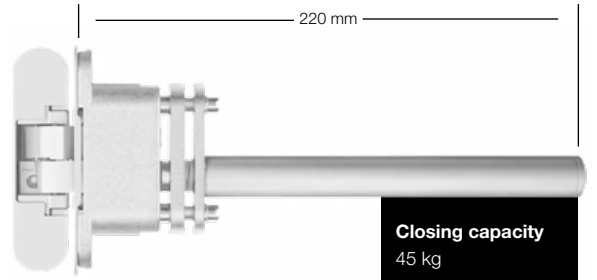

**Closing capacity**  
45 kg

**X4030**

110 x 24 x 27 mm

Easy installation (1 person)

Reversible left-right

Opening angle 180°

Consealed and independent 3D – adjustment  
(side +- 1 mm, height +- 2 mm, compression +- 1 mm)



X4030.W X4030.G X4030.B

X1	X240	X245	X250
X	X	X	X

**X4030-SC**

**SELF-CLOSING HINGE**

110 x 24 x 27 mm

Easy installation (1 person)

Reversible left-right

**To combine with X4030**

Consealed and independent 3D – adjustment  
(side +- 1 mm, height +-2 mm, compression +- 1 mm)



X4030-SC.W X4030-SC.B

X1	X240	X245	X250
X	X	X	X

**CLASSIFICATION KEY**

2	7	2	1	1	4	0	7
---	---	---	---	---	---	---	---

# HINGES

## SPECIAL WALLCOVERINGS

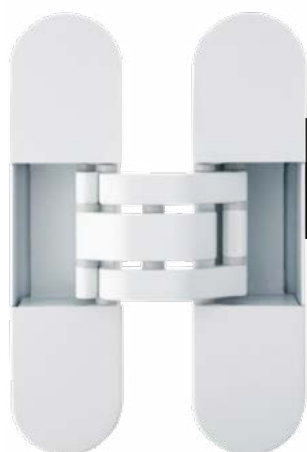

**Load capacity**  
**A300** 60 kg/3 hinges  
**A303** 80 kg/3 hinges

 Fire-resistant tested



**Load capacity**  
 100 kg/2 hinges

### A300/A303

### TECTUS TE540 A8 3D

Wall cladding of 6 mm for flush pull open version

120 x 30 x 30 mm

Reversible left-right

Opening angle 180°

Consealed and independent 3D – adjustment

(side +- 1 mm, height +-2 mm, compression +- 1 mm)

Wall cladding of 6 mm for flush pull open version

200 x 32/37 x 44 mm

Reversible left-right

Opening angle 180°

Consealed and independent 3D – adjustment

(side +- 3 mm, height +-3 mm, compression +- 1 mm)



A300.1    A300.0    A300.2

X1	X240	X245	X250
-	-	X	X



TE540.A8.1    TE540.A8.0    TE540.A8.2

X1	X240	X245	250
-	-	-	X

#### CLASSIFICATION KEY

2	7	3	1	1	*	0	10
---	---	---	---	---	---	---	----

\*depending on the finish





## A57

130 x 32/25 x 53 mm

Easy installation (1 person)

Opening angle 180°

Consealed and independent 3D – adjustment

(side +- 1 mm, height +- 2 mm, compression +- 1,5 mm)



A57.1



A57.0



A57.2

X1	X240	X245	X250
X	-	X	X

# HINGES

HIGH LOAD CAPACITY



## A31

190 x 31 x 35,5 mm

Easy installation (1 person)

Reversible left-right

Opening angle 180°

Consealed and independent 3D – adjustment  
(side +- 1,5 mm, height +- 3 mm, compression +- 1 mm)



A31.1

X1	X240	X245	X250
-	-	X	X

### CLASSIFICATION KEY

4	7	6	1	1	*	1	13
---	---	---	---	---	---	---	----

\*depending on the finish



## TECTUS TE540 3D

200 x 32 x 36,5 mm

Easy installation (1 person)

Reversible left-right

Opening angle 180°

Consealed and independent 3D – adjustment  
(side +- 3 mm, height +- 3 mm, compression +- 1 mm)



TE540.1 TE540.0 TE540.2

X1	X240	X245	X250
-	-	-	X

### CLASSIFICATION KEY

4	7	6	1	1	*	1	13
---	---	---	---	---	---	---	----

\*depending on the finish



## TECTUS TE640

240 x 32 x 32 mm

Easy installation (1 person)

Reversible left-right

Opening angle 180°

Consealed and independent 3D – adjustment  
(side +- 3 mm, height +- 3 mm, compression +- 1 mm)



TE640.1

X1	X240	X245	X250
-	-	-	X

### CLASSIFICATION KEY

4	7	6	1	1	*	1	14
---	---	---	---	---	---	---	----

\*depending on the finish





# ⚡ HINGES

ELECTRIC

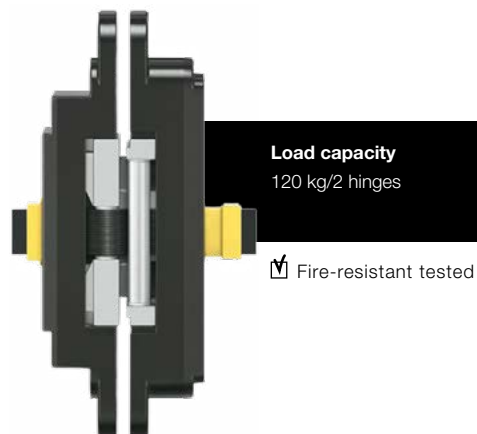
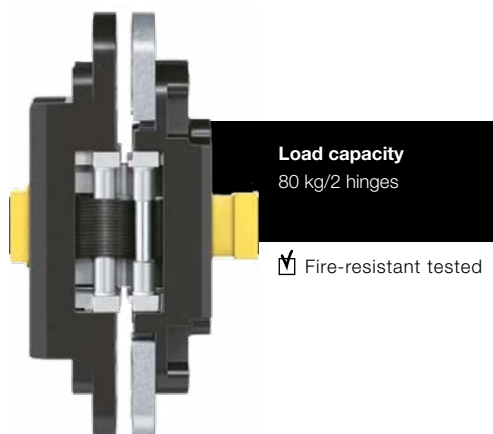

## TECTUS 3D ENERGY TE340

160 x 28 x 28 mm

Reversible left-right

Opening angle 180°

Consealed and independent 3D – adjustment  
(side +- 3 mm, height +- 3 mm, compression +- 1 mm)



TE340.0/ENERGY



TE340.2/ENERGY

X1	X240	X245	X250
X	X	X	X

## TECTUS 3D ENERGY TE540

200 x 32 x 32 mm

Reversible left-right

Opening angle 180°

Consealed and independent 3D – adjustment  
(side +- 3 mm, height +-3 mm, compression +- 1 mm)



TE540.0/ENERGY



TE540.2/ENERGY

X1	X240	X245	X250
-	-	-	X

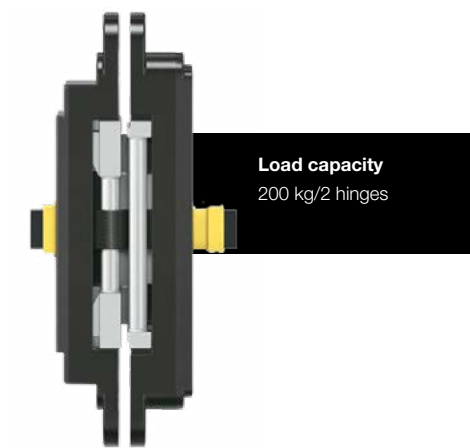

## TECTUS 3D ENERGY

### TE640

240 x 32 x 32 mm

Reversible left-right

Opening angle 180°

Consealed and independent 3D – adjustment

(side +- 3 mm, height +-3 mm, compression +- 1 mm)



TE640.0/ENERGY



TE640.2/ENERGY

X1	X240	X245	X250
-	-	-	X

# LOCKS

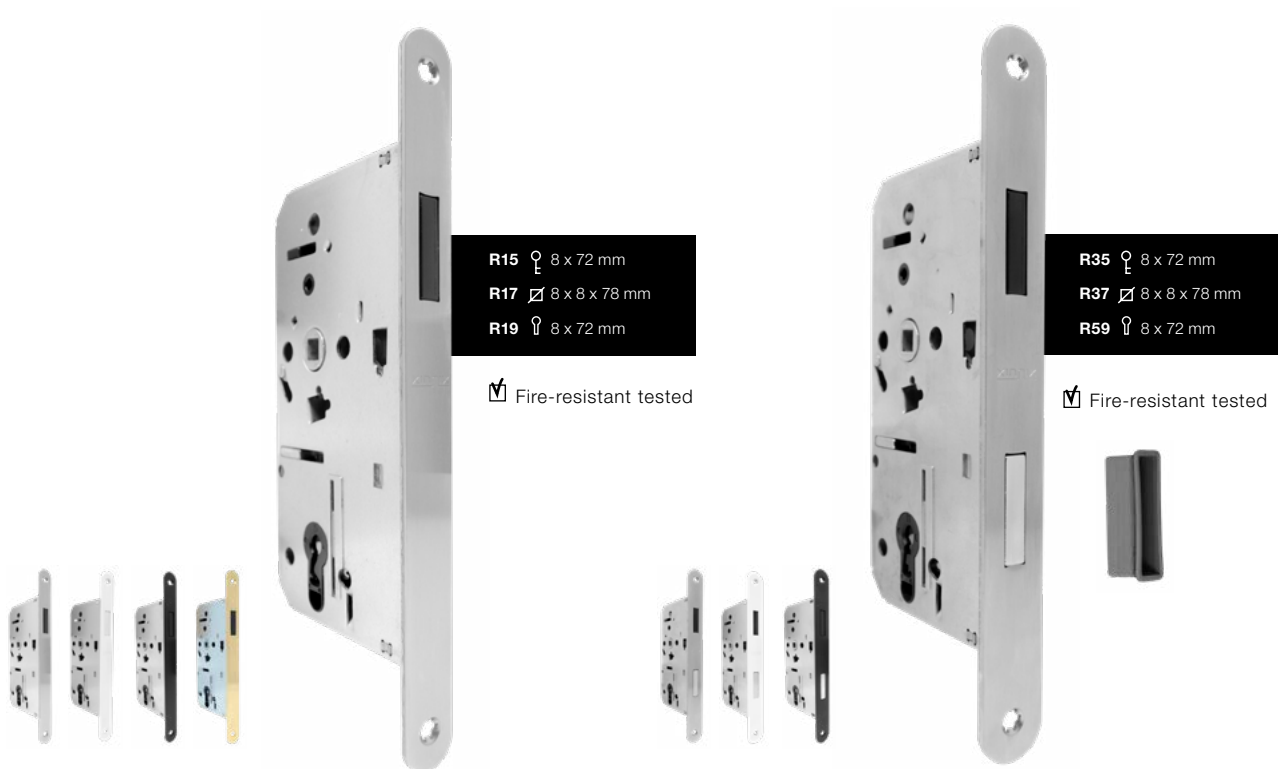

## XINNIX DIN

LATCH

235 x 20 mm

∅ 8 mm

Tested according to UNI EN 12209

Backset = 55 mm

## XINNIX DIN

LATCH AND BOLT

235 x 20 mm

∅ 8 mm

Tested according to UNI EN 12209

Backset = 55 mm

**197**



22 x 82 mm







**XINNIX**  
REVERSIBLE

**ADDITIONAL LOCK**

190 x 22 mm  
 ∅ 8 mm  
 E=50 mm

86 x 18 mm  
 ∅ 8 mm  
 Backset = 50 mm

**I97**

**EX**

Electric counter strike



22 x 82 mm

24 x 140 mm

More information on  
page 59



**G525**

**G526**

**G527**



# LOCKS



**KFV**

**KFV116F**

☑ Fire-resistant tested



**KFV**

**KFV116BB** ⌀ 8 x 72 mm  
**KFV116WC** ⌀ 8 x 8 x 78 mm  
**KFV116PZ** ⌀ 8 x 72 mm

☑ Fire-resistant tested

**KFV**

LATCH

**KFV**

LATCH AND BOLT

235 x 20 mm

∅ 8 mm

Tested according to UNI EN 12209

Backset = 55 mm

235 x 20 mm

∅ 8 mm

Tested according to UNI EN 12209

Backset = 55 mm

**KFV116TP-F**



20 x 120 mm

**EX**

Electric counter strike



24 x 140 mm  
 More information on  
 page 59

**KFV116TP-BB**



20 x 245 mm

**ED**

Electric counter strike



24 x 235 mm  
 More information on  
 page 59



**NZ**

22 x 82 mm  
20 kg tractive force



**NZ190**

22 x 190 mm  
To cover the milling of:  
D70-D73-D78



**NZ290**

22 x 290 mm  
To cover the milling of:  
D85-D87-D88



**NZ190.NH**

22 x 190 mm  
To cover the milling of:  
NoHa lock



# LOCKS

## NO HANDLE SOLUTIONS

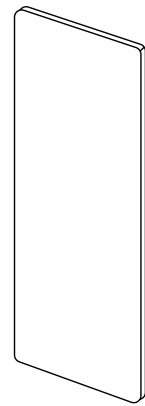

85 x 43 mm

### NOHA LOCK

NO HANDLE

190 x 22 mm  
 ∅ 6 mm  
 Backset = 50 mm

<b>NHNS105</b>	door leaf: 27 mm	1 sided
<b>NHNS200</b>	door leaf: 38-42 mm	2 sided
<b>NHNS205</b>	door leaf: 43-47 mm	2 sided
<b>NHNS210</b>	door leaf: 48-52 mm	2 sided
<b>NHNS250</b>	door leaf: >19 mm	1 sided

### PUSH PLATE

<b>NH003I</b>	3 mm	INOX
<b>NH004M</b>	4 mm	MDF
<b>NH006M</b>	6 mm	MDF
<b>NH016M</b>	16 mm	MDF

### 998NH



22 x 82 mm

### NOHA TOOL



**NH044**

Milling tool 44 mm



Denolf Angellie

# LOCKS

ANTI PANIC



## SOLENOIDE LOCK EL560

LATCH AND BLOT

235 x 20 mm

∅ 9 mm

Backset = 55 mm

EL560 is a solenoid lock which is electrically controlled by a handle, access system, timer, code keyboard or button.

The lock can always be opened by the handle on the panic side. Mechanical opening by means of the cylinder is always possible.

**VINTAGE**



## SECURITY LOCK 1

EI 0 - EI 30

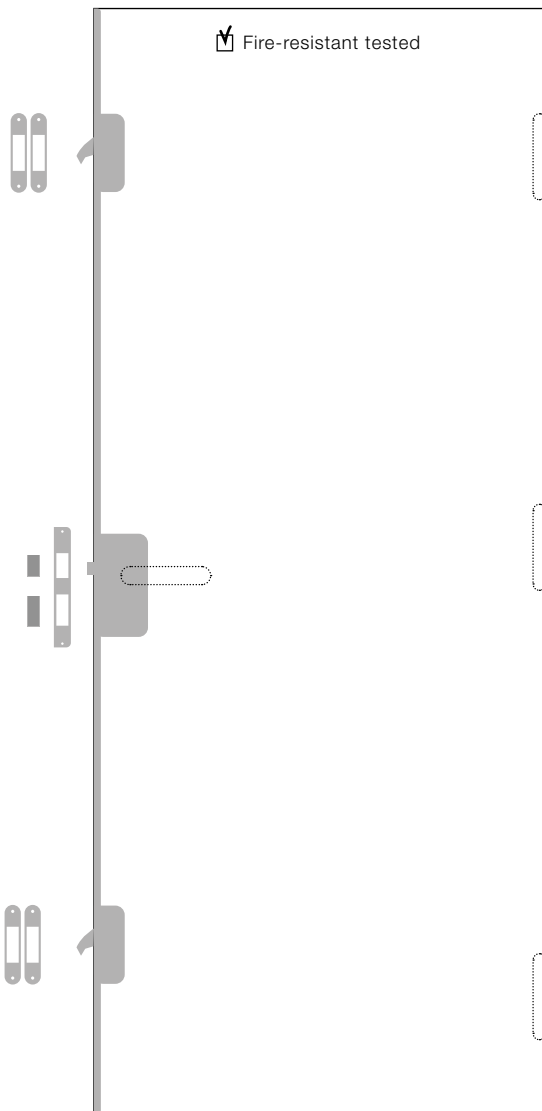

⌀ 8 x 92 mm

Multipoint lock with hooks made of chromed steel and counterstrike in frame colour.

**Lock:** manually

**Unlock:** manually

Maximum height of the lock: 2400 mm

## SECURITY LOCK 2

EI 0 - EI 30

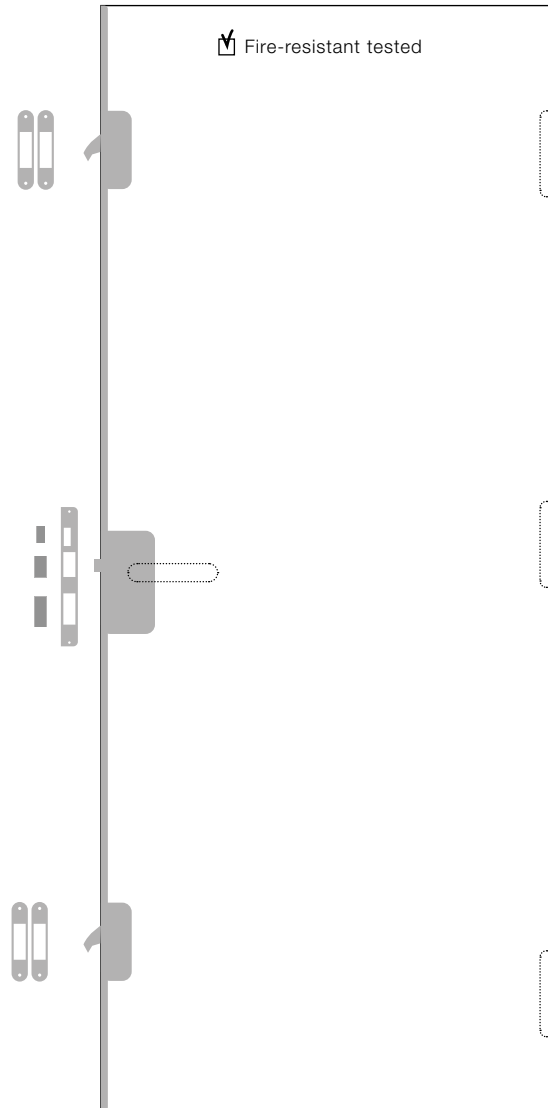

⌀ 8 x 92 mm

Multipoint lock with hooks made of chromed steel and counterstrike in frame colour.

**Lock:** automatically

**Unlock:** manually

Maximum height of the lock: 2400 mm



## SECURITY LOCK 3

EI 0 - EI 30

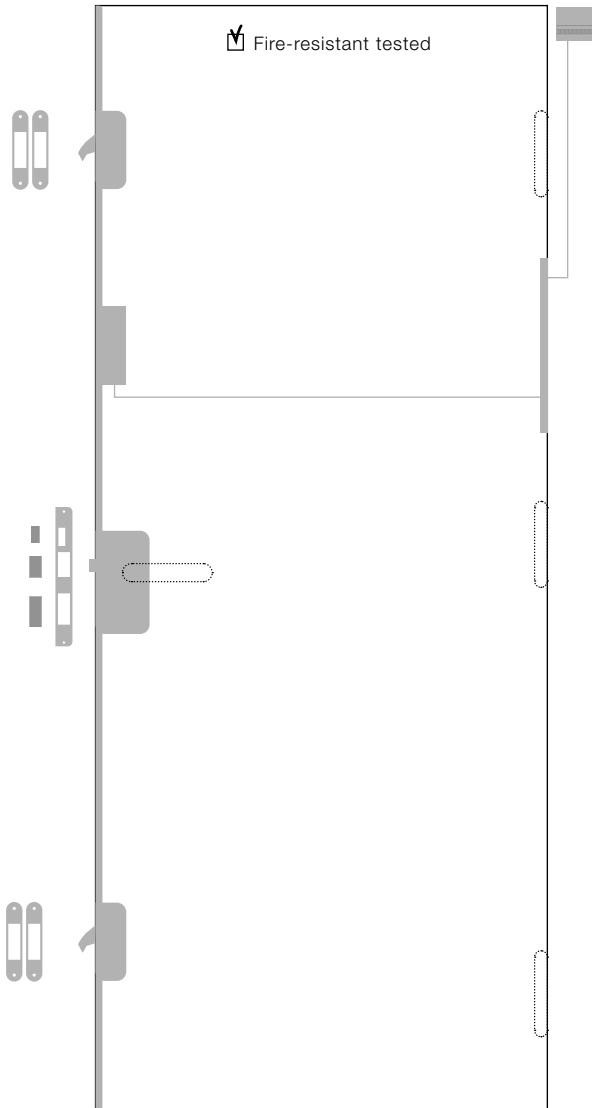

∅ 8 x 92 mm

Multipoint lock with hooks made of chromed steel and counterstrike in frame colour.

**Lock:** automatically

**Unlock:** motor 12V controlled by fingerprint, codes, mobile phone, home automation,...

Maximum height of the lock: 2400 mm

Combine with Tectus Energy



### XA-SECROSE





# ELECTRIC COUNTER STRIKE

## XIN



🔥 Fire-resistant tested

24 x 140 mm

Compatible with magnetic locks

Fit for fire-rated doors

3 mm adjustable

Plug-in connection

Combinable with:

With EL 118: D78

With EL 138: D70/D73/D78 - KFV F

## DIN

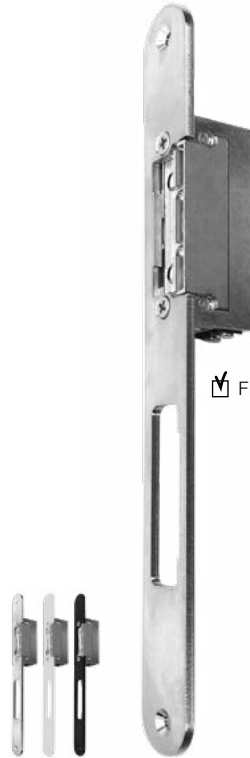

🔥 Fire-resistant tested

24 x 235 mm

Compatible with magnetic locks

Fit for fire-rated doors

3 mm adjustable

Plug-in connection

Combinable with:

With EL 118 and 138: KFV PZ

### EL 118 - Fail, locked solution

The door is locked when there is a power cut.

- 10-24 V

- 22-42 V



### EL 138 - Fail, unlocked solution

The door is unlocked when there is a power cut.

- 12 V

- 24 V





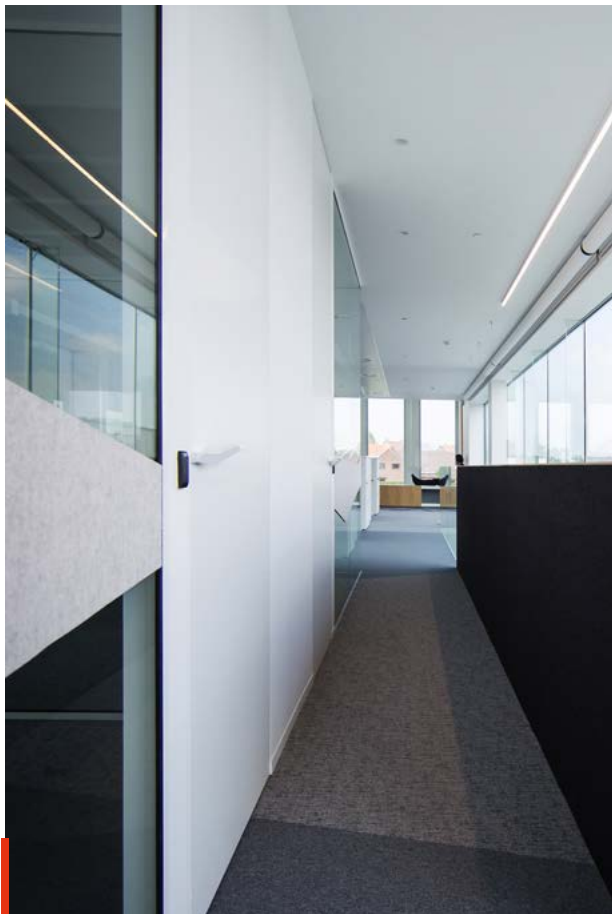

Valerie Clarysse

# DOOR CLOSERS



## ACTIVE STOP



Soft open + soft close  
 Openingslimitor 135°  
 Max 45 kg

X1	X240	X245	X250
X	X	X	X

## LIMIT STOP



Openingslimitor 90°-120°  
 Max 40 kg

X1	X240	X245	X250
X	X	X	X

## BOXER 2-4



✓ Fire-resistant tested

Integrated door closer  
 Door width <1100 mm  
 Max 130 kg

X1	X240	X245	X250
X	X	X	X

## BOXER 3-6



✓ Fire-resistant tested

Integrated door closer  
 Door width <1400 mm  
 Max 180 kg

X1	X240	X245	X250
-	-	-	X

## BOXER E



✓ Fire-resistant tested

Integrated door closer  
 Electro magnetic hold open  
 at 80-120°

X1	X240	X245	X250
-	-	-	X

## BOXER EFS



✓ Fire-resistant tested

Integrated door closer  
 Electro magnetic free swing  
 function

X1	X240	X245	X250
-	-	-	X

## ECTURN



The Ecturn Inside opens and closes doors automatically. Thanks to wireless push buttons, mobile radio remote control units or acoustic signals, the system can be tailored to specific user requirements. The door can also be opened manually in the event of a power failure.

X1	X240	X245	X250
-	-	-	X

### BOXER ISM



☑ Fire-resistant tested

Integrated door closer with closing selector for double doors.

X1	X240	X245	X250
-	-	-	X

### BOXER E ISM



☑ Fire-resistant tested

Integrated automatic door closer with closing selector and electromagnetic hold open for double doors.

X1	X240	X245	X250
-	-	-	X

### BOXER EFS ISM



☑ Fire-resistant tested

Integrated automatic door closer with closing selector and electromagnetic free swing function and closing selector for double doors.

X1	X240	X245	X250
-	-	-	X



without Xinnix



with Xinnix







# FINISHING PROFILE

The finishing profile allows you to easily finish the walls regardless of the wall thickness. The plasterboard features an integrated aluminum corner bead, which speeds up the finishing process and reinforces the corners.

## PER DOOR SET



XA-FIN2088/140/KE1	Set to finish 1 door 2 x 2088x140x9,5 mm + 1 x 1044x140x9,5 mm
XA-FIN2200/120/KE1	Set to finish 1 door 2 x 2200x120x9,5 mm + 1 x 1100x120x9,5 mm
XA-FIN2200/120/KE2	Set to finish 2 doors 4 x 2200x120x9,5 mm + 2 x 1100x120x9,5 mm
XA-FIN2600/120/KE1	Set to finish 1 door 2 x 2600x120x9,5 mm + 1 x 1100x120x9,5 mm
XA-FIN2600/120/KE2	Set to finish 2 doors 4 x 2600x120x9,5 mm + 2 x 1100x120x9,5 mm

## PER 5



XA-FIN2200/120/5	Plasterboard with alu corner 2200x120x9,5 mm
XA-FIN2200/260/5	Plasterboard with alu corner 2200x260x9,5 mm
XA-FIN2600/120/5	Plasterboard with alu corner 2600x120x9,5 mm
XA-FIN3000/120/5	Plasterboard with alu corner 3000x120x9,5 mm
XA-FIN3000/260/5	Plasterboard with alu corner 3000x260x9,5 mm

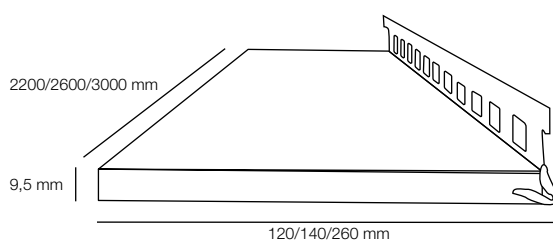

INSTALLATION VIDEO



# PLINTHS

## INTEGRATED ALUMINIUM PLINTHS

### XP50

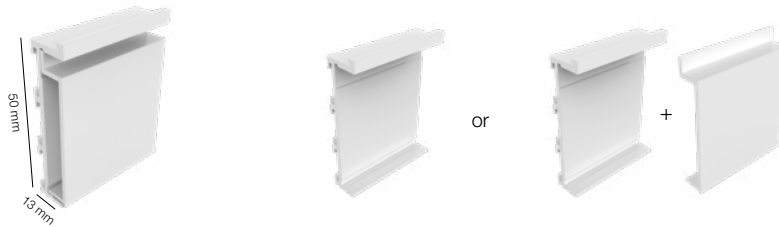

—  
Leave them original or paint them in the colour of the wall after degreasing the plinths.

### Base - 13x50x3000 mm



XP50-3000.W	White primer RAL 9016 SA30
XP50-3000.B	Raw
XP50-3000.A	Anodised F1
XP50-3000.BL	Black primer RAL 9005 SA30

### Cover - 3000 mm



XP50-3000.W.COVER	White primer RAL 9016 SA30
XP50-3000.B.COVER	Raw
XP50-3000.A.COVER	Anodised F1
XP50-3000.BL.COVER	Black primer RAL 9005 SA30
XP50-3000.RVS	Stainless steel top plate

### Installation

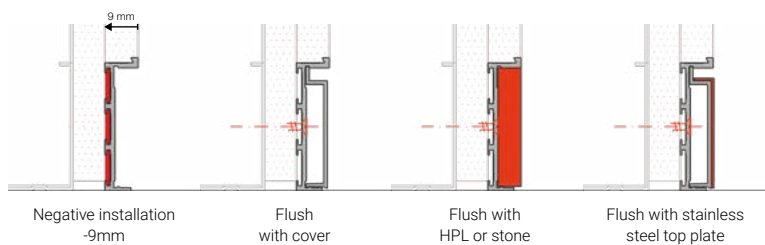

—  
Mechanically fixed or invisibly glued

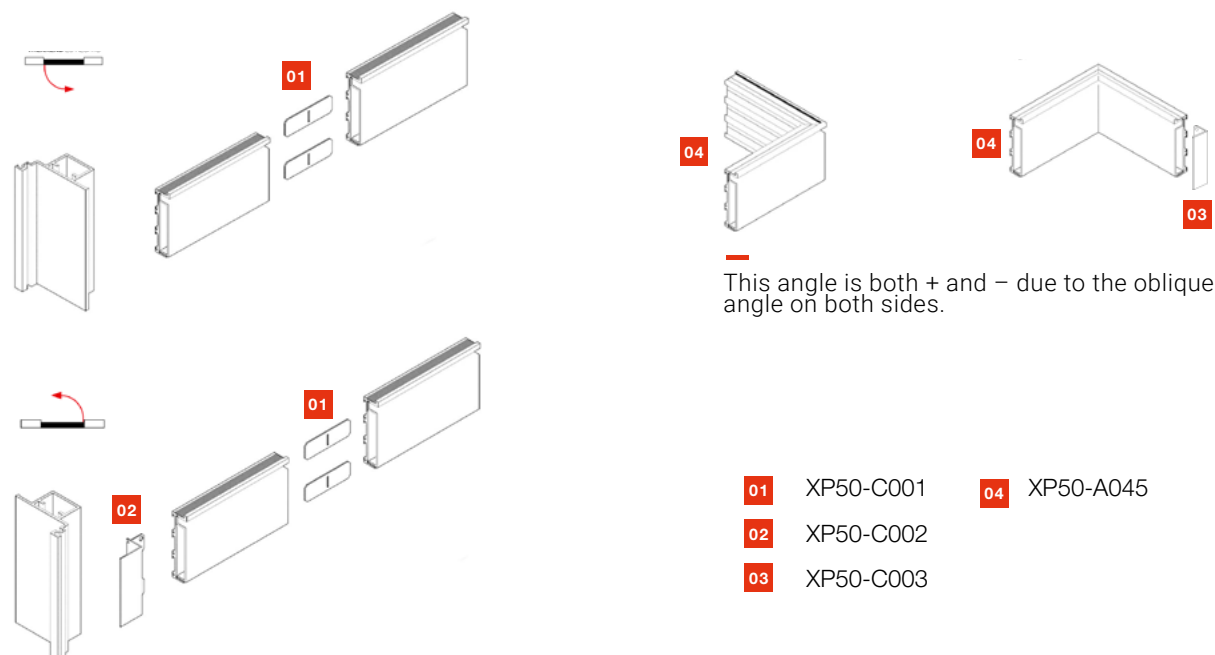

—  
This angle is both + and - due to the oblique angle on both sides.

- 01 XP50-C001
- 02 XP50-C002
- 03 XP50-C003
- 04 XP50-A045

## XP50.04

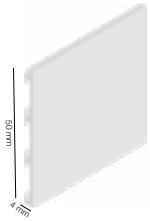

—  
Leave them original or paint them  
in the colour of the wall after  
degreasing the plinths

### Plinth - 4x50x3000 mm



XP50.04-3000.W	White primer RAL 9016 SA30
XP50.04-3000.BL	Black primer RAL 9005 SA30



### Installation

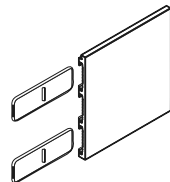
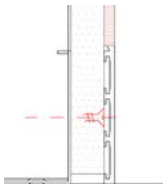

—  
Invisibly glued to the wall.  
In combination with connection piece  
XP50-C001.









[info@xinnix.eu](mailto:info@xinnix.eu)

[www.xinnix.eu](http://www.xinnix.eu)