

serafini.®

1a



B



EXTERIOR



1a

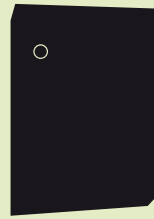
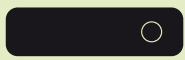
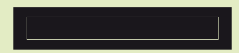

B

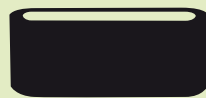

things to love!

serafini products around the front door: especially for outdoor usage products need to offer functionality and durability, besides a great premium-quality design. It's the materials, their processing and combination that create an outstanding overall result.

Products, which are used outdoors, are exposed to strong weather conditions, which they have to withstand. Therefore serafini uses mostly stainless steel in V4A quality for its exterior products. Compared to regular stainless steel in V2A, this material offers a much better resistance against flash rust and selective leaching through a higher percentage of molybdenum and nickel.

The combination of technical perfection and a great sense for design enable the creation of products that are fun and inspiring.

LETTERBOXES

LETTERBOX STANDS

4 – 37



38 – 49



Design by atelier 522

Many **serafini** products are designed by atelier 522, a team of creative minds who live and work next to Lake Constance and primarily love wind in their sails and under their wings. This has influenced their design, their architecture and their meaningful handling of everyday life. The sensuality of smelling, tasting, feeling, and not least of seeing and hearing drives atelier 522 to create increasingly sophisticated interpretations of life.

It is all about new combinations of the known and the familiar, which thereby gain an innovative perceptual quality. In this sense, atelier 522 designs products for serafini that bring together the contradictory nature of emotion and function.

DOOR BELLS

50 – 55



PICTOGRAMS

56 – 59

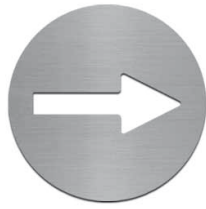

HOUSE NUMBERS

60 – 61



ACCESSORIES

62 – 69





Cap

Corpus: Stainless steel V4A

Front: Stainless steel V4A

■ stainless steel V4A Art.No.: 30.7260.03

Front: Steel, powder-coated

□ traffic white Art.No.: 30.7260.43

■ grey DB 703 Art.No.: 30.7260.45-045

■ orient red Art.No.: 30.7260.57

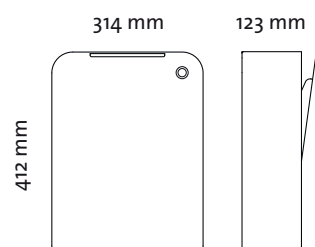

Cap

Corpus: Steel, powder-coated
grey DB703

Front: Stainless steel V4A

■ stainless steel V4A Art.No.: 30.7240.03

Front: Steel, powder-coated

□ traffic white Art.No.: 30.7240.43

■ grey DB 703 Art.No.: 30.7240.45-045

■ orient red Art.No.: 30.7240.57

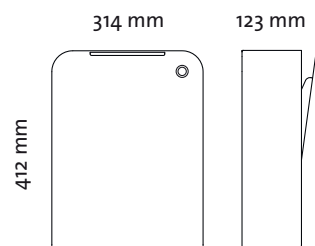

Standpipes Universal

Stainless steel V2A
to be embedded in the ground

with drilling

for newspaper compartment

Art.No.: 30.7270.03

without drilling

for newspaper compartment

Art.No.: 30.7280.03

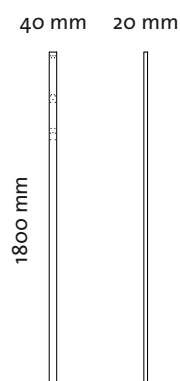



Campbell



Flat

Corpus: Steel, powder-coated

traffic white

Front: Glass

- telegrey 1 Art.No.: 30.7176.38-026
- jet black Art.No.: 30.7176.41
- traffic white Art.No.: 30.7176.43
- grey DB 703 Art.No.: 30.7176.45-045
- deep orange Art.No.: 30.7176.85

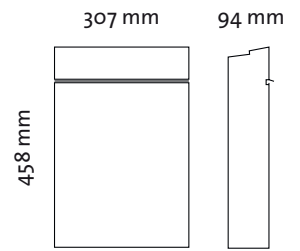

Flat newspaper compartment

Corpus: Steel, powder-coated

traffic white

Front: Glass

- telegrey 1 Art.No.: 30.7178.38-026
- jet black Art.No.: 30.7178.41
- traffic white Art.No.: 30.7178.43
- grey DB 703 Art.No.: 30.7178.45-045
- deep orange Art.No.: 30.7178.85

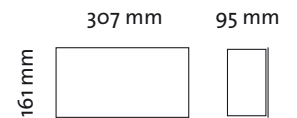

Flat

Corpus: Steel, powder-coated

traffic white

Front: Stainless steel V4A

- stainless steel V4A Art.No.: 30.7170.03
- jet black Art.No.: 30.7170.41
- traffic white Art.No.: 30.7170.43
- grey DB 703 Art.No.: 30.7170.45-045
- orient red Art.No.: 30.7170.57
- grey aluminium Art.No.: 30.7170.67

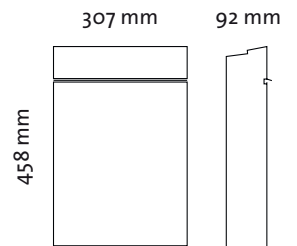

Flat newspaper compartment

Corpus: Steel, powder-coated

traffic white

Front: Stainless steel V4A

- stainless steel V4A Art.No.: 30.7172.03
- jet black Art.No.: 30.7172.41
- traffic white Art.No.: 30.7172.43
- grey DB 703 Art.No.: 30.7172.45-045
- orient red Art.No.: 30.7172.57
- grey aluminium Art.No.: 30.7172.67

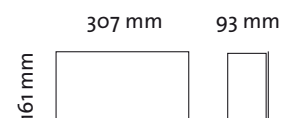

3



House numbers
page 60



Standpipes Universal

Stainless steel V2A
to be embedded in the ground

with drilling
for newspaper compartment
Art.No.: 30.7270.03
without drilling
for newspaper shelf
Art.No.: 30.7280.03

40 mm 20 mm

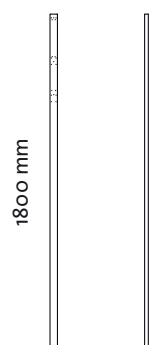



Flat

Corpus: Steel, powder-coated
black structure

Front: Glass

- telegrey 1 Art.No.: 30.7175.38-026
- jet black Art.No.: 30.7175.41
- traffic white Art.No.: 30.7175.43
- grey DB 703 Art.No.: 30.7175.45-045
- deep orange Art.No.: 30.7175.85

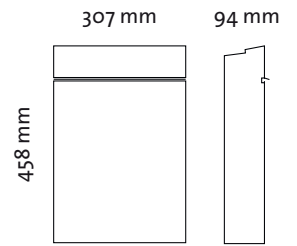

Flat newspaper compartment

Corpus: Steel, powder-coated
black structure

Front: Glass

- telegrey 1 Art.No.: 30.7177.38-026
- jet black Art.No.: 30.7177.41
- traffic white Art.No.: 30.7177.43
- grey DB 703 Art.No.: 30.7177.45-045
- deep orange Art.No.: 30.7177.85

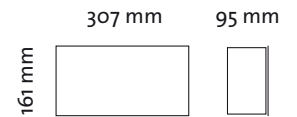

Flat

Corpus: Steel, powder-coated
black structure

Front: Stainless steel V4A

- stainless steel V4A Art.No.: 30.7180.03
- Front: Steel, powder-coated**
- jet black Art.No.: 30.7180.41
- traffic white Art.No.: 30.7180.43
- grey DB 703 Art.No.: 30.7180.45-045
- orient red Art.No.: 30.7180.57
- grey aluminium Art.No.: 30.7180.67

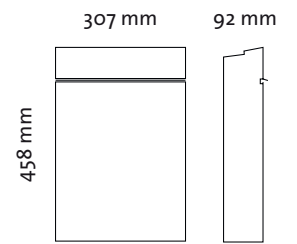

Flat newspaper compartment

Corpus: Steel, powder-coated
black structure

Front: Stainless steel V4A

- stainless steel V4A Art.No.: 30.7182.03
- Front: Steel, powder-coated**
- jet black Art.No.: 30.7182.41
- traffic white Art.No.: 30.7182.43
- grey DB 703 Art.No.: 30.7182.45-045
- orient red Art.No.: 30.7182.57
- grey aluminium Art.No.: 30.7182.67





Flat Wide

Corpus: Steel, powder-coated

traffic white

Front: Glass

■ telegrey 1	Art.No.: 30.7186.38-026
■ jet black	Art.No.: 30.7186.41
□ traffic white	Art.No.: 30.7186.43
■ grey DB 703	Art.No.: 30.7186.45-045
■ deep orange	Art.No.: 30.7186.85

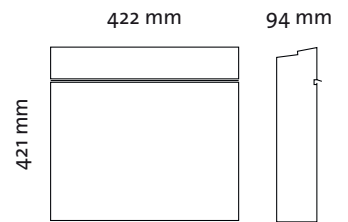

Flat Wide newspaper compartment

Corpus: Steel, powder-coated

traffic white

Front: Glass

■ telegrey 1	Art.No.: 30.7188.38-026
■ jet black	Art.No.: 30.7188.41
□ traffic white	Art.No.: 30.7188.43
■ grey DB 703	Art.No.: 30.7188.45-045
■ deep orange	Art.No.: 30.7188.85



Flat Wide

Corpus: Steel, powder-coated

traffic white

Front: Stainless steel V4A

■ stainless steel V4A	Art.No.: 30.7195.03
■ jet black	Art.No.: 30.7195.41
□ traffic white	Art.No.: 30.7195.43
■ grey DB 703	Art.No.: 30.7195.45-045
■ orient red	Art.No.: 30.7195.57
■ grey aluminium	Art.No.: 30.7195.67

Front: Steel, powder-coated

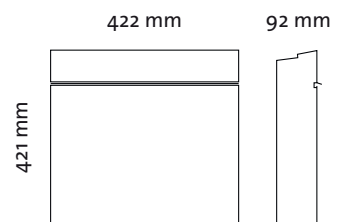

Flat Wide newspaper compartment

Corpus: Steel, powder-coated

traffic white

Front: Stainless steel V4A

■ stainless steel V4A	Art.No.: 30.7197.03
■ jet black	Art.No.: 30.7197.41
□ traffic white	Art.No.: 30.7197.43
■ grey DB 703	Art.No.: 30.7197.45-045
■ orient red	Art.No.: 30.7197.57
■ grey aluminium	Art.No.: 30.7197.67

Front: Steel, powder-coated

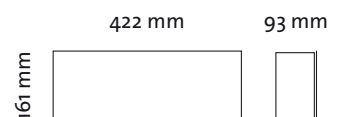



Flat Wide

Corpus: Steel, powder-coated
black structure

Front: Glass

- telegrey 1 Art.No.: 30.7185.38-026
- jet black Art.No.: 30.7185.41
- traffic white Art.No.: 30.7185.43
- grey DB 703 Art.No.: 30.7185.45-045
- deep orange Art.No.: 30.7185.85

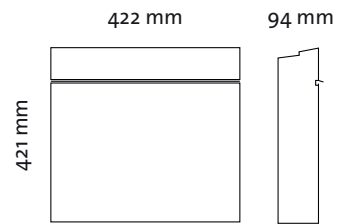

Flat Wide newspaper compartment

Corpus: Steel, powder-coated
black structure

Front: Glass

- telegrey 1 Art.No.: 30.7187.38-026
- jet black Art.No.: 30.7187.41
- traffic white Art.No.: 30.7187.43
- grey DB 703 Art.No.: 30.7187.45-045
- deep orange Art.No.: 30.7187.85

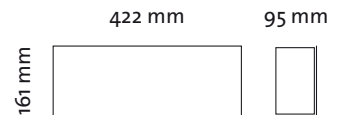

Flat Wide

Corpus: Steel, powder-coated
black structure

Front: Stainless steel V4A

- stainless steel V4A Art.No.: 30.7190.03
- Front: Steel, powder-coated**
- jet black Art.No.: 30.7190.41
- traffic white Art.No.: 30.7190.43
- grey DB 703 Art.No.: 30.7190.45-045
- orient red Art.No.: 30.7190.57
- grey aluminium Art.No.: 30.7190.67

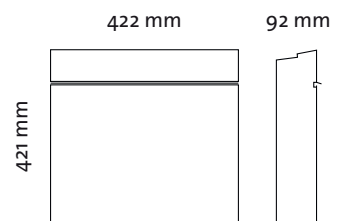

Flat Wide newspaper compartment

Corpus: Steel, powder-coated
black structure

Front: Stainless steel V4A

- stainless steel V4A Art.No.: 30.7192.03
- Front: Steel, powder-coated**
- jet black Art.No.: 30.7192.41
- traffic white Art.No.: 30.7192.43
- grey DB 703 Art.No.: 30.7192.45-045
- orient red Art.No.: 30.7192.57
- grey aluminium Art.No.: 30.7192.67

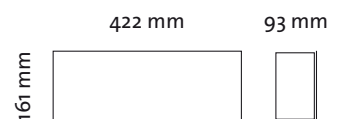



Standpipes Universal

Stainless steel V2A
to be embedded in the ground

with drilling

for newspaper compartment
Art.No.: 30.7270.03

without drilling

for newspaper compartment
Art.No.: 30.7280.03

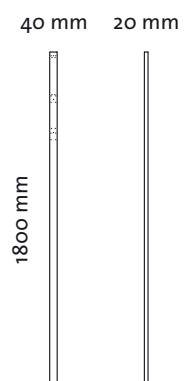



S-Box

Corpus: Steel, powder-coated
traffic white

Front: Stainless steel V4A

■ stainless steel V4A Art.No.: 30.7160.03

Front: Steel, powder-coated

■ jet black Art.No.: 30.7160.41

□ traffic white Art.No.: 30.7160.43

■ grey DB 703 Art.No.: 30.7160.45-045

■ orient red Art.No.: 30.7160.57

■ grey aluminium Art.No.: 30.7160.67

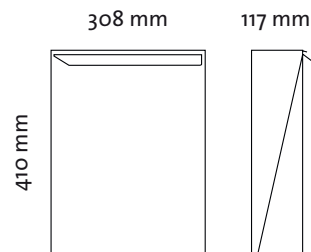

S-Box

Corpus: Steel, powder-coated
black structure

Front: Stainless steel V4A

■ stainless steel V4A Art.No.: 30.7150.03

Front: Steel, powder-coated

■ jet black Art.No.: 30.7150.41

□ traffic white Art.No.: 30.7150.43

■ grey DB 703 Art.No.: 30.7150.45-045

■ orient red Art.No.: 30.7150.57

■ grey aluminium Art.No.: 30.7150.67

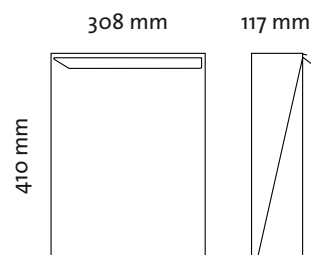

S-Box newspaper compartment

Corpus: Stainless steel V4A

■ stainless steel V4A Art.No.: 30.7152.03

Corpus: Steel, powder-coated

■ jet black Art.No.: 30.7152.41

□ traffic white Art.No.: 30.7152.43

■ grey DB 703 Art.No.: 30.7152.45-045

■ orient red Art.No.: 30.7152.57

■ grey aluminium Art.No.: 30.7152.67

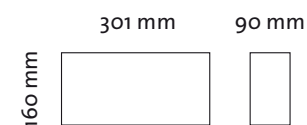

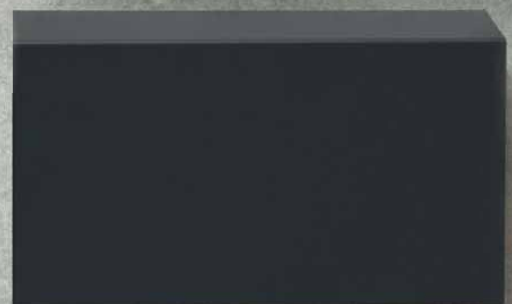

serafini.



Concrete

Corpus: Concrete, stone grey
Inner corpus: Steel, powder-coated
black structure
Shutter: Stainless steel V4A
Art.No.: 30.0405.99

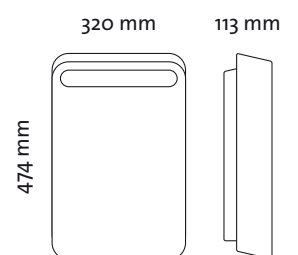



1a



Protection class
IP 44

Concrete Light

Corpus: Concrete, stone grey
Inner corpus: Steel, powder-coated
 black structure
Lamp: 1 x energy saving lamp
 TC-D 13 W, 230V/50 Hz
 Art.No.: 30.0378.10

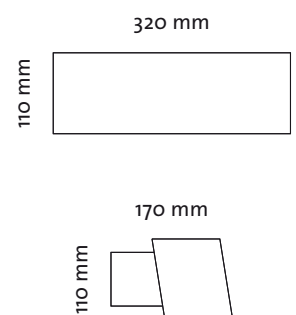



Concrete CQ

Corpus: Concrete, stone grey

Front: Steel, powder-coated white

Art.No.: 30.0407.99

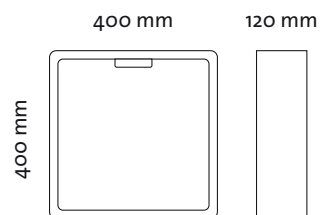

Concrete CQ

Corpus: Concrete, stone grey

Front: Steel, powder-coated black structure

Art.No.: 30.0403.99

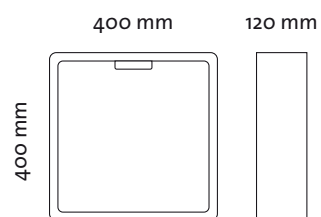



1a

Square
page 20

Square Light
page 20



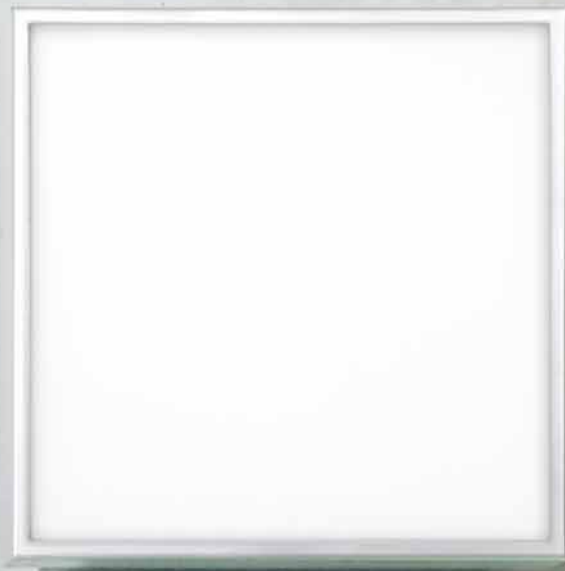



Square

Corpus: Steel, powder-coated
black structure

Front: Stainless steel V4A

■ stainless steel V4A Art.No.: 30.7125.03

Front: Steel, powder-coated

- jet black Art.No.: 30.7125.41
- traffic white Art.No.: 30.7125.43
- grey DB 703 Art.No.: 30.7125.45-045
- orient red Art.No.: 30.7125.57
- colza yellow Art.No.: 30.7125.61-006
- grey aluminium Art.No.: 30.7125.67
- deep orange Art.No.: 30.7125.85

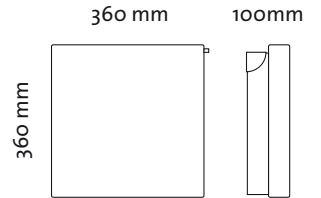

Square newsletter compartment

Front: Stainless steel V4A

■ stainless steel V4A Art.No.: 30.7129.03

Front: Steel, powder-coated

- jet black Art.No.: 30.7129.41
- traffic white Art.No.: 30.7129.43
- grey DB 703 Art.No.: 30.7129.45-045
- orient red Art.No.: 30.7129.57
- black structure Art.No.: 30.7129.59
- colza yellow Art.No.: 30.7129.61-006
- grey aluminium Art.No.: 30.7129.67
- deep orange Art.No.: 30.7129.85



Standpipes Universal

Stainless steel V2A
to be embedded in the ground

with drilling

for newspaper compartment

Art.No.: 30.7270.03

without drilling

for newspaper compartment

Art.No.: 30.7280.03

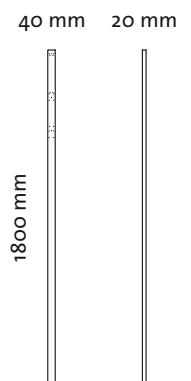

Square Light

Corpus: Steel, powder-coated
black structure

Front: Stainless steel V4A / Acrylic,
ivory translucent

Lamp: 2 x energy saving lamp

TC-L 18 W, 230V/50 Hz

Art.No.: 30.7128.03

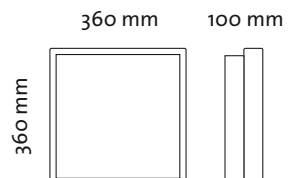

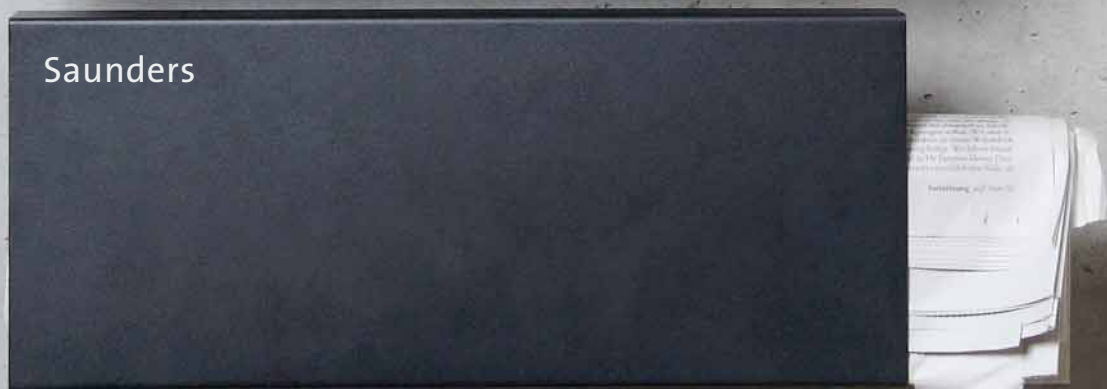

House numbers
page 60

serafini.



Taylor

Wright



Smith

Donnelly

Letterbox Slim
page 24



Slim

Front: Stainless steel V4A

■ stainless steel V4A Art.No.: 30.7126.03

Front: Steel, powder-coated

- jet black Art.No.: 30.7126.41
- traffic white Art.No.: 30.7126.43
- grey DB 703 Art.No.: 30.7126.45-045
- orient red Art.No.: 30.7126.57
- colza yellow Art.No.: 30.7126.61-006
- grey aluminium Art.No.: 30.7126.67
- deep orange Art.No.: 30.7126.85

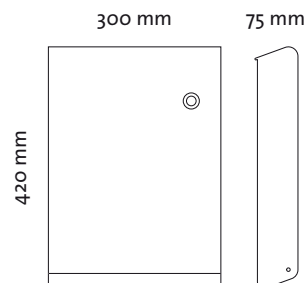

Slim newspaper compartment

Front: Stainless steel V4A

■ stainless steel V4A Art.No.: 30.7127.03

Front: Steel, powder-coated

- jet black Art.No.: 30.7127.41
- traffic white Art.No.: 30.7127.43
- grey DB 703 Art.No.: 30.7127.45-045
- orient red Art.No.: 30.7127.57
- colza yellow Art.No.: 30.7127.61-006
- grey aluminium Art.No.: 30.7127.67
- deep orange Art.No.: 30.7127.85

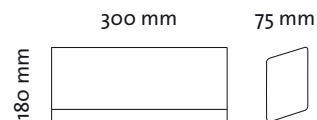



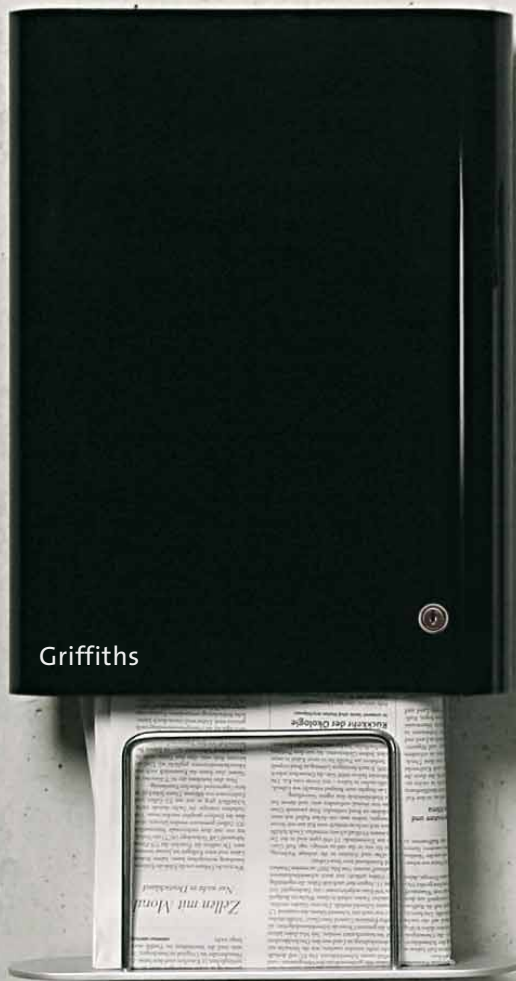

Unique Box lockable

Lid / Base: Aluminium
matt silver anodised

Back panel: Steel, powder-coated
white aluminium

Corpus: Stainless steel V4A

■ stainless steel V4A Art.No.: 30.0399.03

Corpus: Steel, powder-coated

■ jet black Art.No.: 30.0399.41

□ traffic white Art.No.: 30.0399.43

286 mm

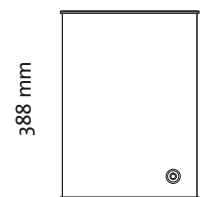

388 mm

76 mm





Protection class
IP 44

Unique Light

Lid / Base: Aluminium
matt silver anodised

Back panel: Steel, powder-coated
white aluminium

Corpus: Acrylic,
ivory translucent

Lamp: 2 x energy saving lamp

TC S 11W, 230V/50Hz

Art.No.: 30.0315.99

286 mm

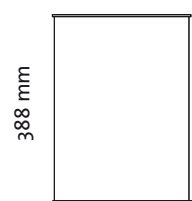

388 mm

76 mm





Line One

Corpus: Steel, powder-coated
black structure
Front: Stainless steel V4A
Art.No.: 30.6440.03

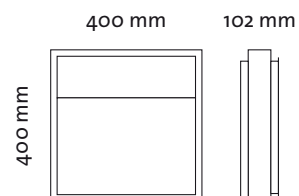

Line One newspaper compartment

Front: Steel, powder-coated
black structure
Art.No.: 30.6444.59

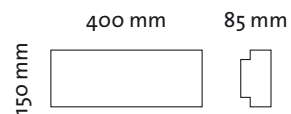

Standpipes Universal

Stainless steel V2A
to be embedded in the ground

with drilling
for newspaper compartment
Art.No.: 30.7270.03
without drilling
for newspaper compartment
Art.No.: 30.7280.03

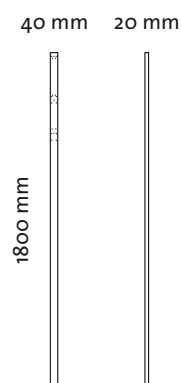

1a

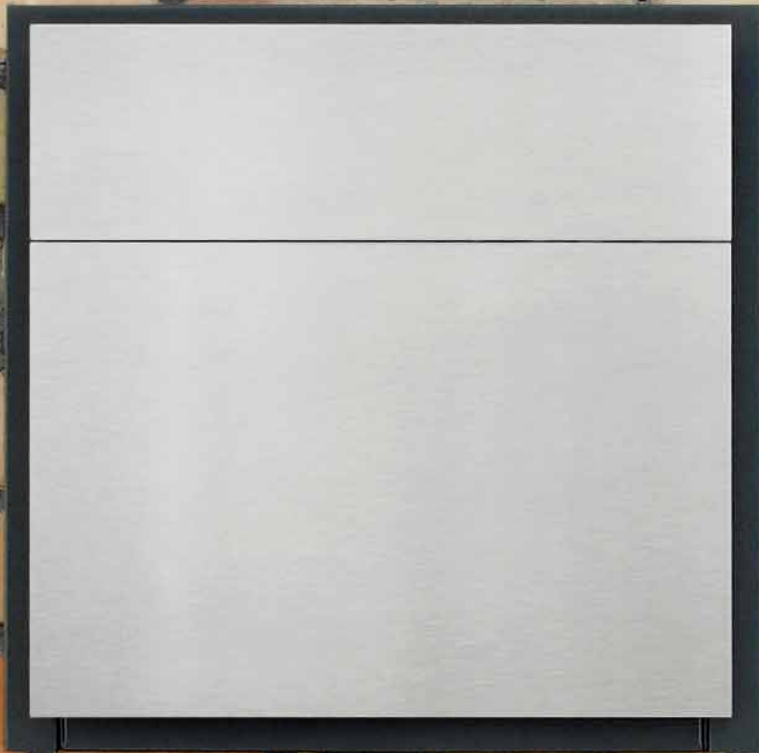

House numbers
page 60

Door bell panel
page 50





Business

Front: Steel, powder-coated
traffic white
Art.No.: 30.7140.43

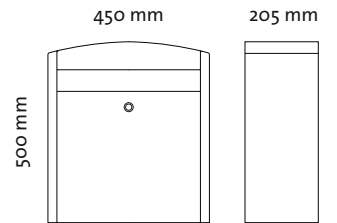

Business

Front: Steel, powder-coated
grey aluminium
Art.No.: 30.7140.67

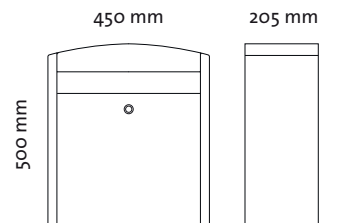





Letterbox

Front / Corpus: Stainless steel V4A
Shutter dimensions: 285 mm x 38 mm
Art.No.: 30.6450.03

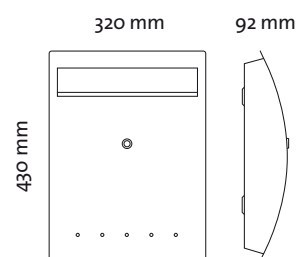

Newspaper compartment

Front / Corpus: Stainless steel V4A
Art.No.: 30.6455.03



Letterbox*

Front / Corpus: Stainless steel V4A
Shutter dimensions: 365 mm x 38 mm
Art.No.: 30.6460.03

*also available as a free-standing
letterbox stand, page 46

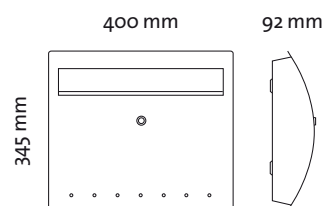

Newspaper compartment

Front / Corpus: Stainless steel V4A
Art.No.: 30.6465.03







**Letterbox
with newspaper compartment**

Front / Corpus: Stainless steel V4A
Shutter dimensions: 280 mm x 45 mm
Art.No.: 30.6490.03

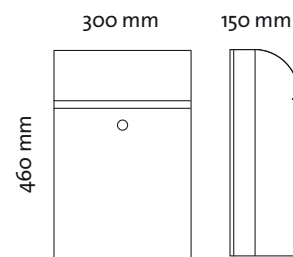

Letterbox*

Front / Corpus: Stainless steel V4A
Shutter dimensions: 380 mm x 45 mm
Art.No.: 30.6492.03

*also available as a free-standing
letterbox stand, page 46

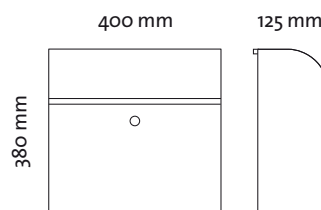

Newspaper compartment

Front / Corpus: Stainless steel V4A
Art.No.: 30.6494.03

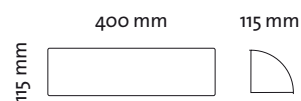



serafini.

Door bell panel
page 50

House numbers
page 60



Letter drop

Stainless steel V4A
Shutter dimensions: 260 mm x 38 mm
L = 335 mm
Art.No.: 30.6521.03

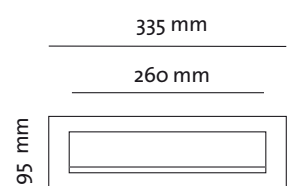

Letter drop

Stainless steel V4A

Shutter dimensions: 250 mm x 36 mm

L = 300 mm Art.No.: 30.6515.03

Shutter dimensions: 350 mm x 36 mm

L = 400 mm Art.No.: 30.6526.03

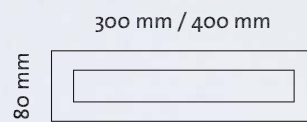
**Inner shutter**

Stainless steel V4A

L = 325 mm Art.No.: 30.6519.03

L = 425 mm Art.No.: 30.6529.03

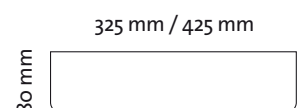

serafini.



Beck







**Letterbox stand Flat
with newspaper compartment**

Corpus: Steel, powder-coated
traffic white

Front: Glass

- telegrey 1 Art.No.: 30.7176.38-026_SA
- jet black Art.No.: 30.7176.41_SA
- traffic white Art.No.: 30.7176.43_SA
- grey DB 703 Art.No.: 30.7176.45-045_SA
- deep orange Art.No.: 30.7176.85_SA

Standpipes Universal: Details on page 7

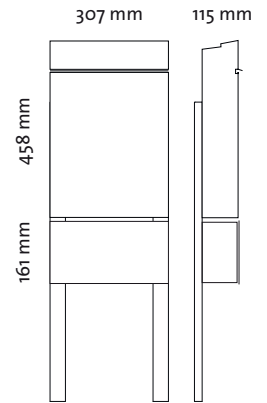

**Letterbox stand Flat
with newspaper compartment**

Corpus: Steel, powder-coated
traffic white

Front: Stainless steel V4A

- stainless steel V4A Art.No.: 30.7170.03_SA
- jet black Art.No.: 30.7170.41_SA
- traffic white Art.No.: 30.7170.43_SA
- grey DB 703 Art.No.: 30.7170.45-045_SA
- orient red Art.No.: 30.7170.57_SA
- grey aluminium Art.No.: 30.7170.67_SA

Standpipes Universal: Details on page 7

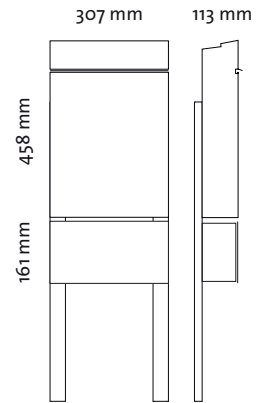

**Letterbox stand Flat
with newspaper compartment**

Corpus: Steel, powder-coated
black structure

Front: Glass

- telegrey 1 Art.No.: 30.7175.38-026_SA
- jet black Art.No.: 30.7175.41_SA
- traffic white Art.No.: 30.7175.43_SA
- grey DB 703 Art.No.: 30.7175.45-045_SA
- deep orange Art.No.: 30.7175.85_SA

Standpipes Universal: Details on page 7

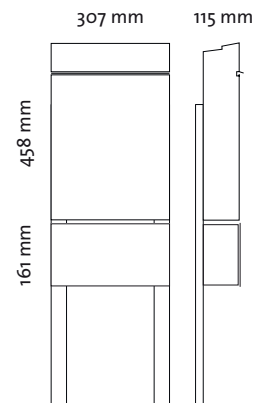

**Letterbox stand Flat
with newspaper compartment**

Corpus: Steel, powder-coated
black structure

Front: Stainless steel V4A

- stainless steel V4A Art.No.: 30.7180.03_SA
- jet black Art.No.: 30.7180.41_SA
- traffic white Art.No.: 30.7180.43_SA
- grey DB 703 Art.No.: 30.7180.45-045_SA
- orient red Art.No.: 30.7180.57_SA
- grey aluminium Art.No.: 30.7180.67_SA

Standpipes Universal: Details on page 7

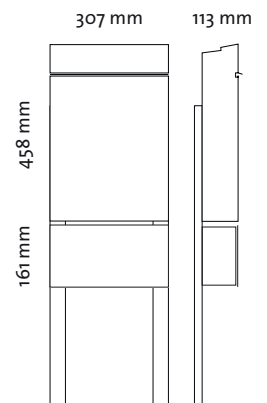





Letterbox stand Flat Wide

Corpus: Steel, powder-coated
traffic white

Front: Glass

- telegrey 1 Art.No.: 30.7186.38-026_SA
- jet black Art.No.: 30.7186.41_SA
- traffic white Art.No.: 30.7186.43_SA
- grey DB 703 Art.No.: 30.7186.45-045_SA
- deep orange Art.No.: 30.7186.85_SA

Standpipes Universal: Details on page 11

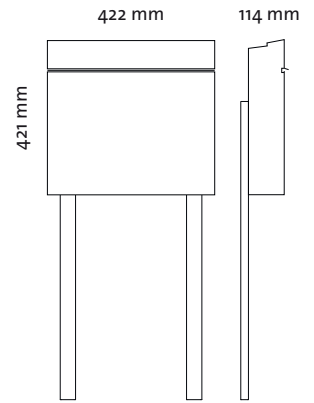

Letterbox stand Flat Wide

Corpus: Steel, powder-coated
traffic white

Front: Stainless steel V4A

- stainless steel V4A Art.No.: 30.7195.03_SA
- jet black Art.No.: 30.7195.41_SA
- traffic white Art.No.: 30.7195.43_SA
- grey DB 703 Art.No.: 30.7195.45-045_SA
- orient red Art.No.: 30.7195.57_SA
- grey aluminium Art.No.: 30.7195.67_SA

Standpipes Universal: Details on page 11

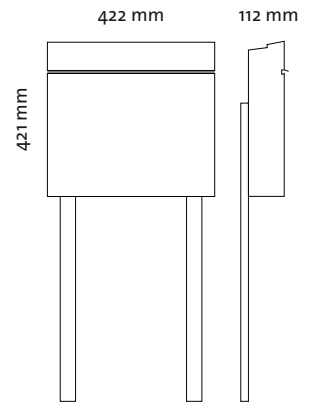

Letterbox stand Flat Wide

Corpus: Steel, powder-coated
black structure

Front: Glass

- telegrey 1 Art.No.: 30.7185.38-026_SA
- jet black Art.No.: 30.7185.41_SA
- traffic white Art.No.: 30.7185.43_SA
- grey DB 703 Art.No.: 30.7185.45-045_SA
- deep orange Art.No.: 30.7185.85_SA

Standpipes Universal: Details on page 11

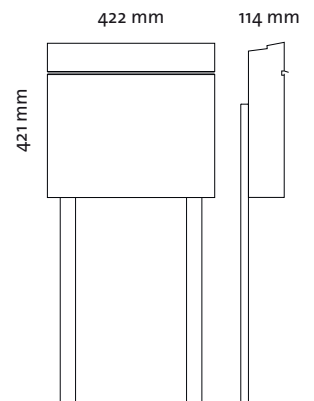

Letterbox stand Flat Wide

Corpus: Steel, powder-coated
black structure

Front: Stainless steel V4A

- stainless steel V4A Art.No.: 30.7190.03_SA
- jet black Art.No.: 30.7190.41_SA
- traffic white Art.No.: 30.7190.43_SA
- grey DB 703 Art.No.: 30.7190.45-045_SA
- orient red Art.No.: 30.7190.57_SA
- grey aluminium Art.No.: 30.7190.67_SA

Standpipes Universal: Details on page 11

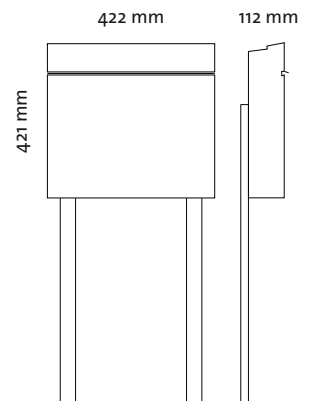



Beck



Letterbox stand Square with newspaper compartment

Corpus: Steel, powder-coated
black structure

Front: Stainless steel V4A

■ stainless steel V4A Art.No.: 30.7125.03_SA

Front: Steel, powder-coated

- jet black Art.No.: 30.7125.41_SA
- traffic white Art.No.: 30.7125.43_SA
- grey DB 703 Art.No.: 30.7125.45-045_SA
- orient red Art.No.: 30.7125.57_SA
- colza yellow Art.No.: 30.7125.61-006_SA
- grey aluminium Art.No.: 30.7125.67_SA
- deep orange Art.No.: 30.7125.85_SA

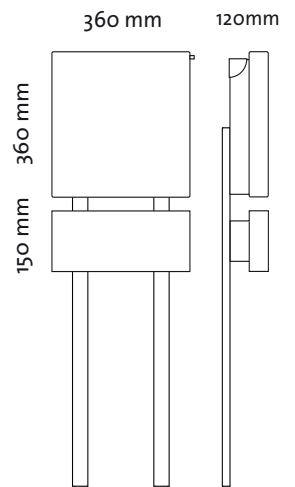

Standpipes Universal: Details on page 20



Letterbox stand Line One with newspaper compartment

Corpus: Steel, powder-coated
black structure

Front: Stainless steel V4A

■ stainless steel V4A Art.No.: 30.6440.03_SA

Standpipes Universal: Details on page 28

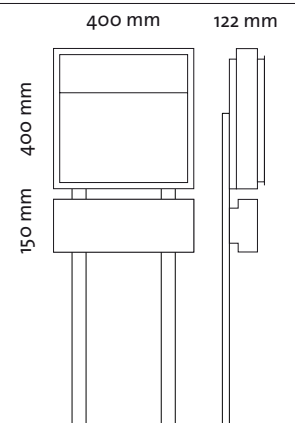

Letterbox stand Cap DB 703

Corpus: Steel, powder-coated
grey DB 703

Front: Stainless steel V4A

■ stainless steel V4A Art.No.: 30.7240.03_SA

Front: Steel, powder-coated

- traffic white Art.No.: 30.7240.43_SA
- grey DB 703 Art.No.: 30.7240.45-045_SA
- orient red Art.No.: 30.7240.57_SA

Standpipes Universal: Details on page 4

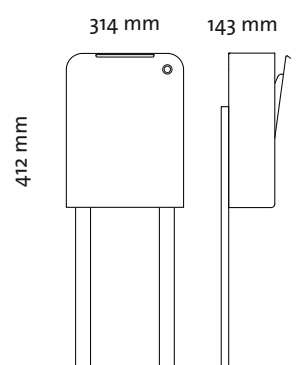

Letterbox stand Cap V4A

Corpus: Stainless steel V4A

Front: Stainless steel V4A

■ stainless steel V4A Art.No.: 30.7260.03_SA

Front: Steel, powder-coated

- traffic white Art.No.: 30.7260.43_SA
- grey DB 703 Art.No.: 30.7260.45-045_SA
- orient red Art.No.: 30.7260.57_SA

Standpipes Universal: Details on page 4

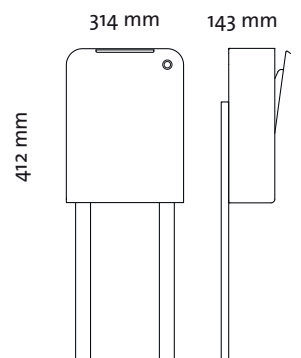



Adam



**Letterbox stand
with newspaper compartment**

to be embedded in the ground
Stainless steel V4A
Art.No.: 30.6487.03

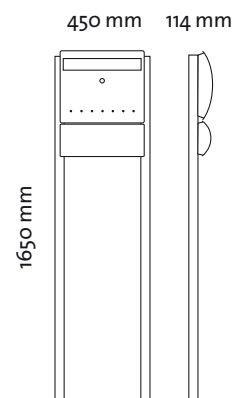

**Cover
with foot mounting**

Stainless steel V4A
Art.No.: 30.6474.03

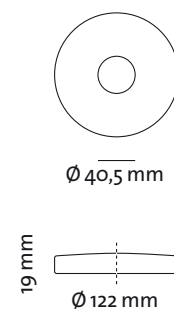

Letterbox stand

to be embedded in the ground
Stainless steel V4A
Art.No.: 30.6489.03

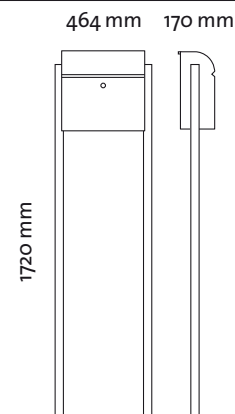

**Cover
with foot mounting**

Stainless steel V4A
Art.No.: 30.6474.03

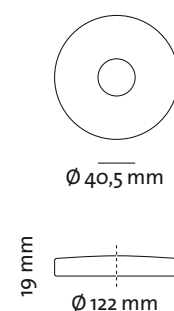





Duplex letterbox system

Stainless steel V4A

Backlit

name and house number panel
with intercom and door bell

D = 100 mm Art.No.: 30.6536.03

D = 285 mm Art.No.: 30.6539.03

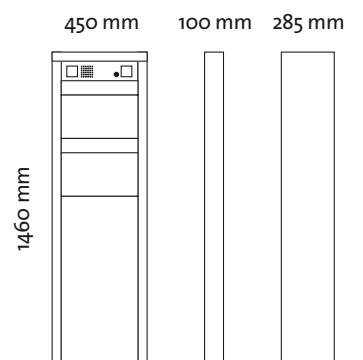



House numbers
page 60



Letterbox system

Stainless steel V4A

Backlit

name and house number panel
with intercom and door bell

D = 100 mm Art.No.: 30.6531.03

D = 285 mm Art.No.: 30.6534.03

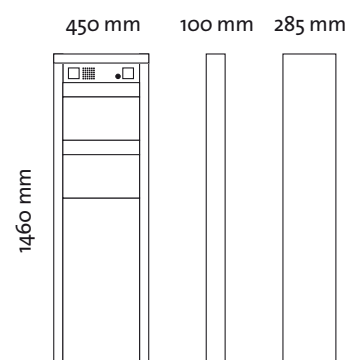



Door bell panel

Stainless steel V4A
THK = 3 mm
Art.No.: 30.6594.03

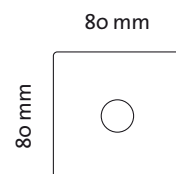

Door bell panel

Stainless steel V4A
THK = 3 mm
Art.No.: 30.6596.03

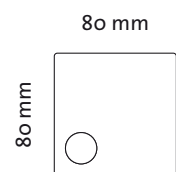

Door bell panel

Stainless steel V4A
THK = 3 mm
Art.No.: 30.6598.03

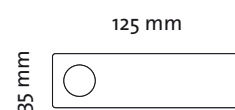

Name plate

Stainless steel V4A
THK = 1 mm
self-adhesive, not engraved
Art.No.: 30.6468.03

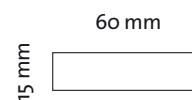





Door bell panel

Stainless steel V4A
THK = 3 mm
Art.No.: 30.6584.03

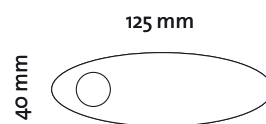

Name plate

Stainless steel V4A
THK = 3 mm
Art.No.: 30.6582.03

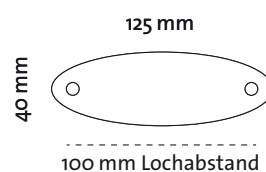

Door bell panel

Stainless steel V4A
THK = 3 mm
Art.No.: 30.6588.03

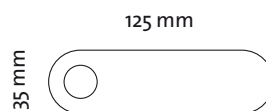

Name plate

Stainless steel V4A
THK = 3 mm
Art.No.: 30.6586.03

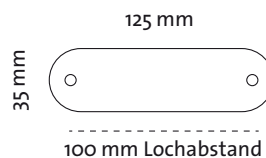

Door bell panel

Stainless steel V4A
THK = 3 mm
Art.No.: 30.6580.03

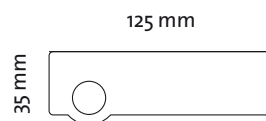

Name plate

Stainless steel V4A
THK = 3 mm
Art.No.: 30.6599.03

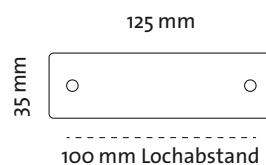





Door bell panel

Stainless steel V4A
THK = 3 mm
Art.No.: 30.6590.03

Ø 80 mm

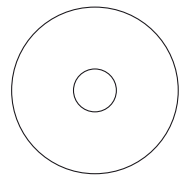

Door bell panel

Stainless steel V4A
THK = 3 mm
Art.No.: 30.6592.03

Ø 60 mm

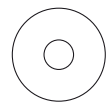

Door bell panel

Stainless steel V4A
THK = 3 mm
Art.No.: 30.6574.03

147 mm

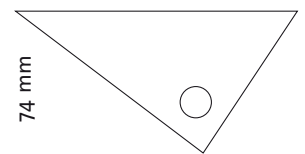

74 mm

65 mm Gravur-Breite



Door bell panel

Stainless steel V4A
THK = 3 mm
Art.No.: 30.6572.03

100 mm

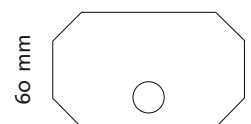

60 mm

65 mm Gravur-Breite



Letter drop
page 36

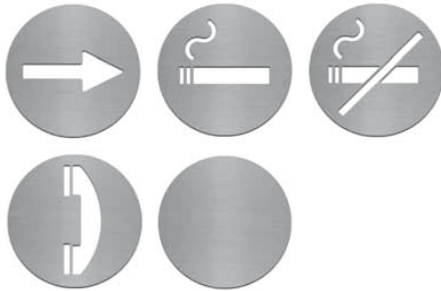
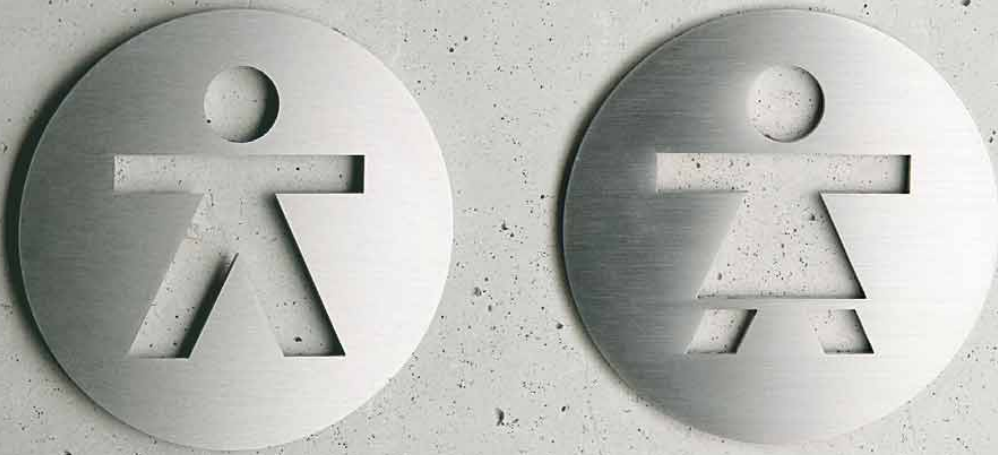

Pictograms

Stainless steel V4A, self-adhesive

Direction	Art.No.: 30.6703.03
Smoker	Art.No.: 30.6706.03
Non-Smoker	Art.No.: 30.6707.03
Telephone neutral	Art.No.: 30.6708.03

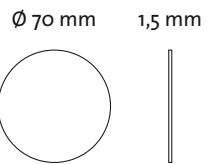

Pictograms

Stainless steel V4A, self-adhesive

Baby changing room	Art.No.: 30.6711.03
Disabled	Art.No.: 30.6702.03
Cloakroom	Art.No.: 30.6704.03
Waiting room	Art.No.: 30.6705.03

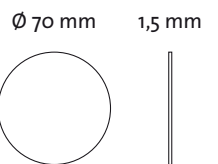

Pictograms

Stainless steel V4A, self-adhesive

Gentlemen	Art.No.: 30.6701.03
Ladies	Art.No.: 30.6700.03
Lavatory	Art.No.: 30.6710.03
Lavatory (to sit)	Art.No.: 30.6712.03

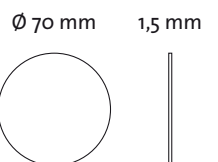



Pictograms

Stainless steel V4A, self-adhesive

- Gentlemen Art.No.: 30.7001.03
- Ladies Art.No.: 30.7000.03
- Lavatory Art.No.: 30.7010.03
- Lavatory (to sit) Art.No.: 30.7019.03

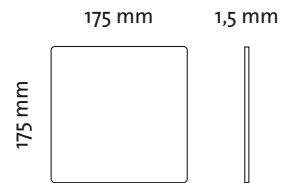

Pictograms

Stainless steel V4A, self-adhesive

- Baby changing room Art.No.: 30.7014.03
- Disabled Art.No.: 30.7002.03
- Gentlemen Option Art.No.: 30.7013.03
- Ladies Option Art.No.: 30.7012.03

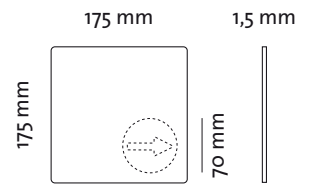

Pictograms

Stainless steel V4A, self-adhesive

- Ladies/Gentlemen Art.No.: 30.7011.03
- Shower Art.No.: 30.7016.03
- Shower/Ladies Art.No.: 30.7017.03
- Shower/Gentlemen Art.No.: 30.7018.03

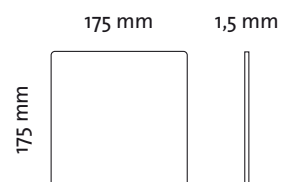



Pictograms

Stainless steel V4A, self-adhesive

Direction 90° Art.No.: 30.7003.03

Direction 45° Art.No.: 30.7004.03

Smoker Art.No.: 30.7007.03

Non-Smoker Art.No.: 30.7008.03

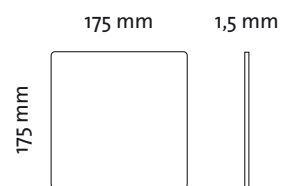

Pictograms

Stainless steel V4A, self-adhesive

Cloakroom Art.No.: 30.7005.03

Waiting room Art.No.: 30.7006.03

Telephone Art.No.: 30.7009.03

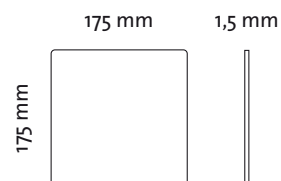

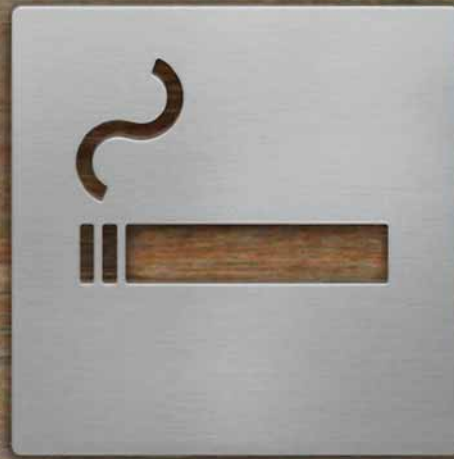

Pictograms

Stainless steel V4A, self-adhesive

Gentlemen	Art.No.: 30.7041.03
Ladies	Art.No.: 30.7040.03
Hyphen	Art.No.: 30.7046.03
Disabled	Art.No.: 30.7042.03

1,5 mm



Pictograms

Stainless steel V4A, self-adhesive

Direction	Art.No.: 30.7043.03
Waiting room	Art.No.: 30.7044.03
Telephone	Art.No.: 30.7045.03

1,5 mm



1a

Stainless steel house numbers

Stainless steel V4A
H = max. 150 mm
x = number needed

to hammer in, THK = 3 mm

0-9 Art.No.: 30.640x.03
a-z Art.No.: 30.64(10-35).03

self-adhesive, THK = 1 mm

0-9 Art.No.: 30.720x.03
a-z Art.No.: 30.72(10-35).03



Stainless steel capital letters

Stainless steel V4A
H = max. 150 mm

to hammer in, THK = 3 mm

A-Z Art.No.: 30.64(10-35).03G
/ Art.No.: 30.6436.03
- Art.No.: 30.6438.03

self-adhesive, THK = 1 mm

A-Z Art.No.: 30.72(10-35).03G
/ Art.No.: 30.7236.03
- Art.No.: 30.7238.03

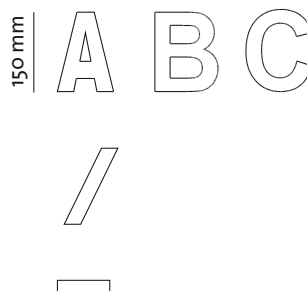

1a

Stainless steel house numbers small

Stainless steel V4A
H = max. 75 mm
x = number needed

self-adhesive, THK = 1,5 mm

0-9 Art.No.: 30.750x.03
a-d Art.No.: 30.75(10-13).03



acht



Folding hook

Stainless steel V4A
Art.No.: 30.6930.03

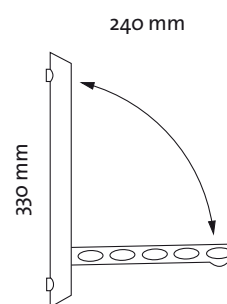



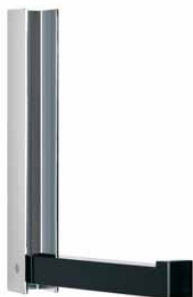

Folding hook Flap

Corpus: chromed
Folding hook: Acrylic, glossy
black
Art.No.: 30.0308.35

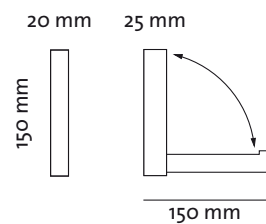

Folding hook Flap

Corpus: chromed
Folding hook: Acrylic, glossy
orange
Art.No.: 30.0309.35

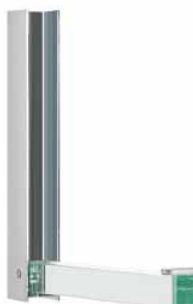
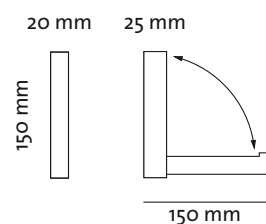

Folding hook Flap

Corpus: chromed
Folding hook: Acrylic, glossy
glass-look
Art.No.: 30.0310.35

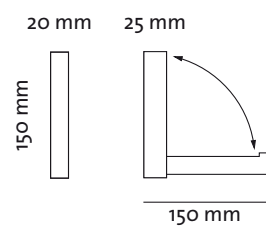





Coat hanger

Hook: chromed
Acrylic, glossy
black
Art.No.: 30.0311.04

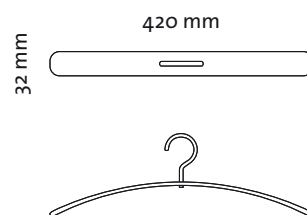

Coat hanger

Hook: chromed
Acrylic, glossy
orange
Art.No.: 30.0312.04

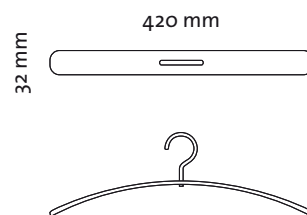

Coat hanger

Hook: chromed
Acrylic, glossy
glass-look
Art.No.: 30.0313.04

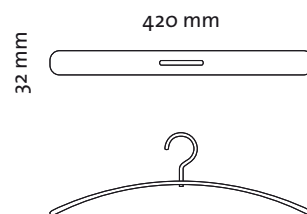

Coat hanger

Hook: chromed
Acrylic, glossy
white
Art.No.: 30.0328.04

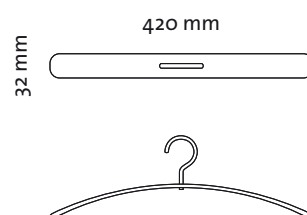





Hook

Stainless steel V4A
Art.No.: 30.6002.03

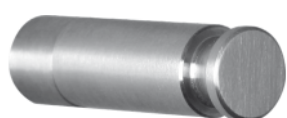
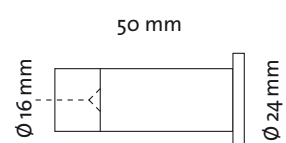

Hook

Stainless steel V4A
Art.No.: 30.6005.03

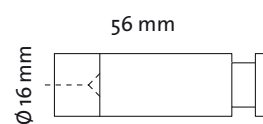



Hook

Stainless steel V4A

Ø 60 mm acrylic glass disc, glossy

- white Art.No.: 30.5998.03
- black Art.No.: 30.5999.03
- orange transparent Art.No.: 30.6000.03
- glass-look Art.No.: 30.6001.03

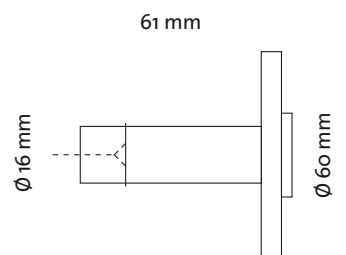

Hook

Stainless steel V4A
Art.No.: 30.6003.03

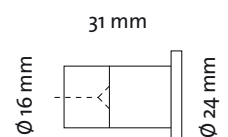

Besides producing and selling high-quality interior and exterior design products, **serafini** offers tailor-made shop presentation systems as well as shelving and partition systems for renowned clients from the trade, commerce and service industry. serafini also focuses on integrating these systems adequately into the existing projects of their clients. **serafini** – things to love.

CLIPS



SLIDE 4



SLIDE 6/8



EASY



PROJECT MANAGEMENT



FULL-SERVICE



PRODUCTION



KNOW-HOW



LINE

PRESENTATION SYSTEMS

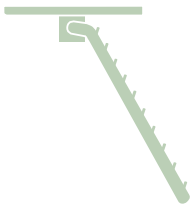

Designing and setting up show rooms and stores has become a complex task nowadays, where architecture, design and merchandising have to be brought together in a goal-oriented manner. For over 30 years **serafini** has developed tailor-made shop systems and office equipment, which allow a flexible presentation of goods. It is the company's aim to put different types of highly differentiated product groups into the spotlight – without any distraction. **serafini** presentation systems support the sales process and guide the customer through an attractive customer journey.

This includes the highest quality, best technology and an aesthetic approach that brings goods and customers together in order to create a unique shopping experience.

INTERNATIONALITY

CLIENT SOLUTIONS



Constantly changing markets and demands require an ever more flexible project management. Managing, coordinating and controlling different projects efficiently at the same time is what counts today.

With **serafini**, you can benefit from the long-standing experience and expertise. Professional advice in every phase of your project – from concept through production of the first prototypes to mass production. Thanks to its ever-growing network **serafini** offers the possibility to carry out all individual operations for you that are necessary for the realization of your projects – without compromising your high demands. As a specialist for materials the manufacturer in Iserlohn is familiar with all materials and surfaces. Whether it's wood, metal, glass, acrylic, leather, plastic or concrete – **serafini** guarantees a design that suits the material and offers perfect workmanship.

Acrylic



Aluminium

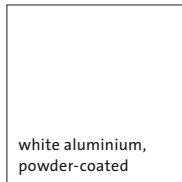

Concrete



Stainless steel



Glass

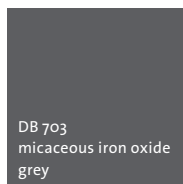

Steel, powder-coated

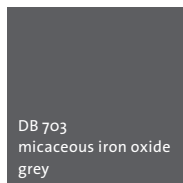

serafini®

Paul Serafini GmbH & Co. KG

Giesestr. 30
D - 58636 Iserlohn
Fon +49 (0) 23 71 / 771 0
Fax +49 (0) 23 71 / 771 110

www.serafini.de
verkauf@serafini.de

Abbreviations

L = Length H = Height
D = Depth THK = Thickness

Copyright

serafini is a registered trademark. Copying or marketing of serafini systems including its accessories requires a written consent.

General Terms and Conditions

All orders are subject to the general terms and conditions of Paul Serafini GmbH & Co KG.

Reservation

All information is subject to technical and formal changes. Load data and load capacities refer to a professionally set up and executed installation, in accordance with the manufacturer's requirements. The installation requires an appropriate load balancing.

Disclaimer

serafini systems and components are subject to safety checks of external supervision by the TUV Nord certification body. They require an orderly installation of the systems by trained professionals, as well as a balanced load distribution. The manufacturer is not liable for defects caused by inappropriate or improper use, incorrect installation / commissioning through the customer or third parties, normal wear and tear, or faulty or negligent treatment. The same applies to the consequences of improper modifications or modifications applied without the manufacturer's consent or maintenance by the customer or a third party.

serafini.®

Paul Serafini GmbH & Co. KG

Giesestr. 30

D - 58636 Iserlohn

Fon +49 (0) 2371 / 771 0

Fax +49 (0) 2371 / 771 110

www.serafini.de

verkauf@serafini.de