

A minimalist interior space with concrete walls and a large white panel. The scene is lit from the left, creating a strong contrast and highlighting the textures of the concrete and the smooth surface of the white panel. A modern, metallic chair is positioned in the lower-left corner, adding a touch of design to the industrial setting.

SYSTEM M
MOUNTING MANUAL

FritsJurgens®

TABLE OF CONTENTS

MOUNTING MANUAL SYSTEM M

- 04 Components
- 06 Technical drawings
- 09 Milling drawings
- 10 Mounting manual
- 20 Closing seam setting
- 22 Setting the radial position
- 23 Setting the closing speed

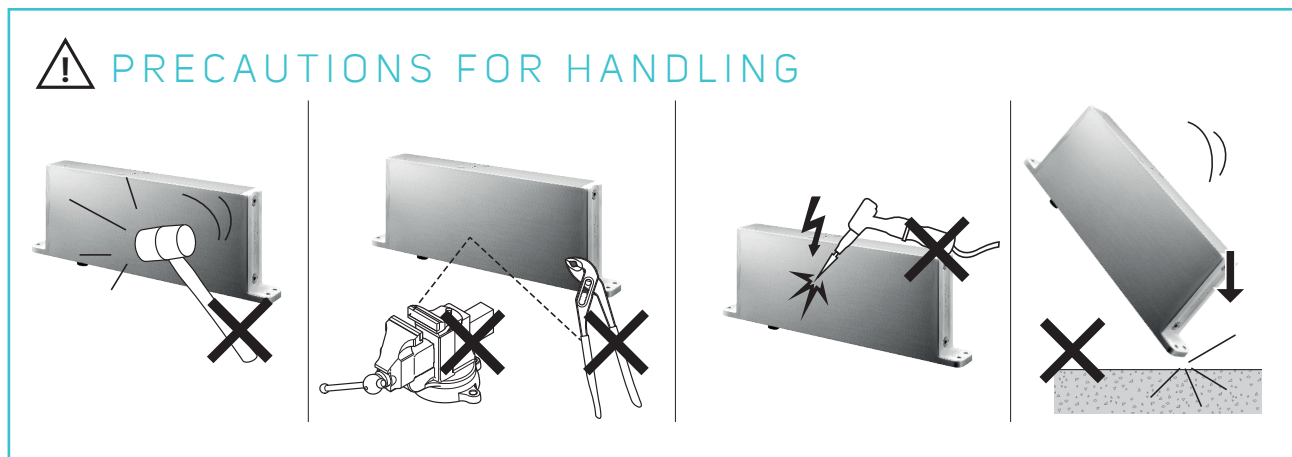

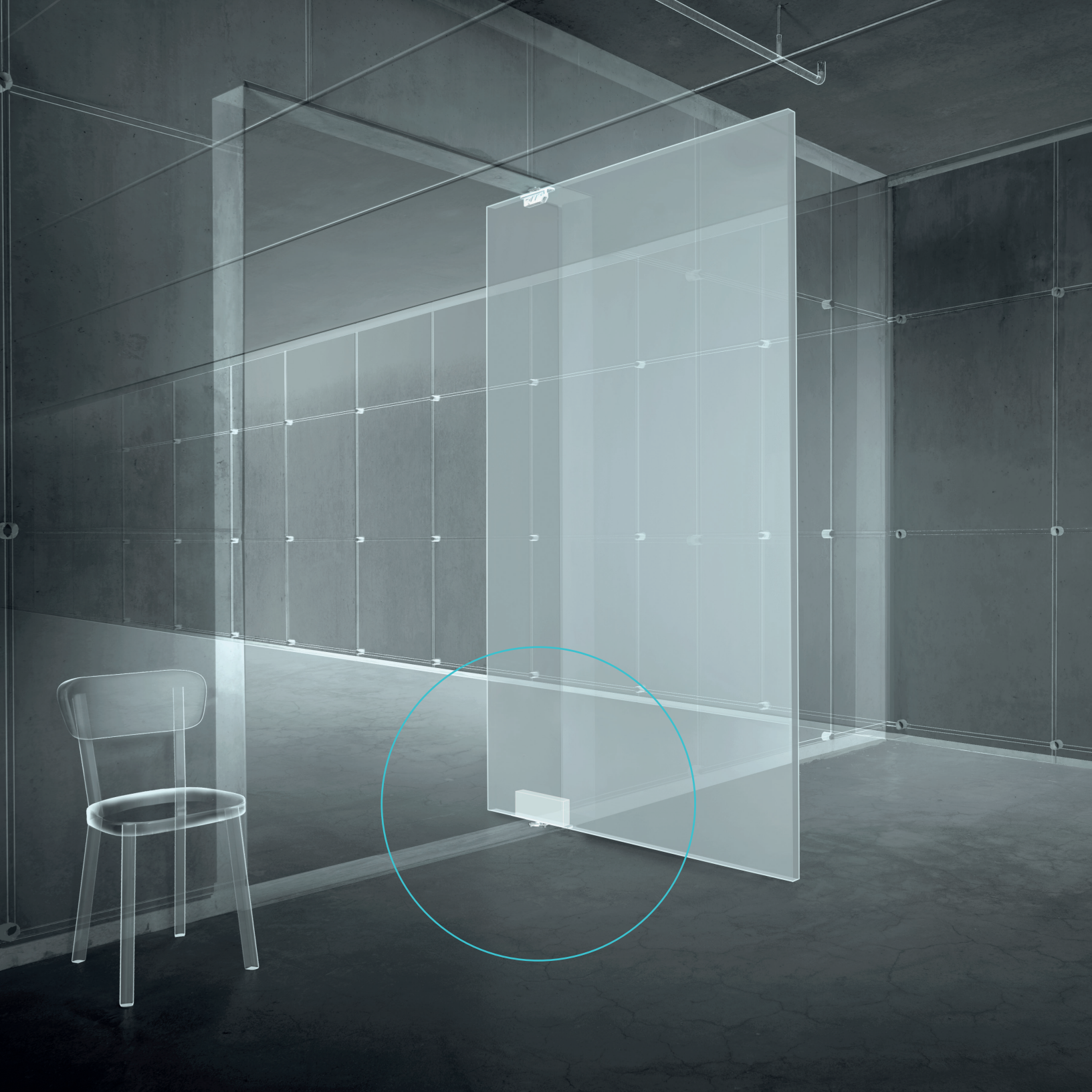

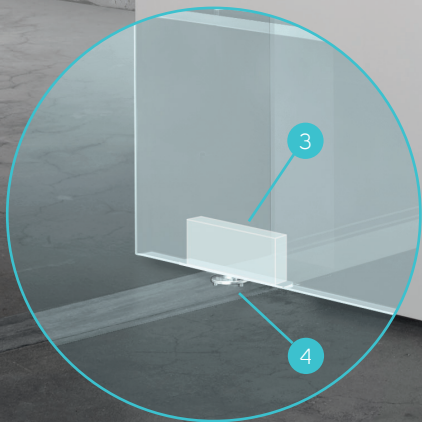
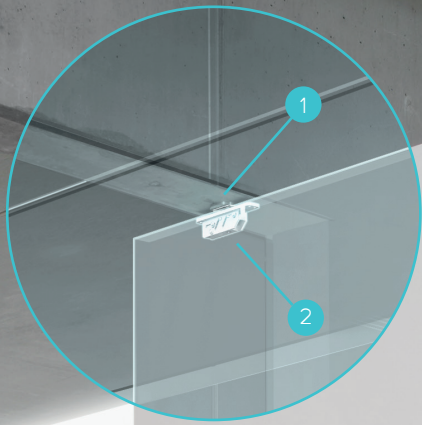

SYSTEM M COMPONENTS

1 CEILING PLATE

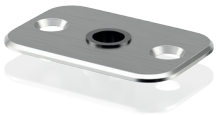

2 TOP PIVOT



3 SYSTEM M



4 FLOORPLATE



A MOUNTING PACKAGE

- A. Allen wrench
- B. Fitting template
- C. Fitting adhesive
- D. Adjustment spanner

B SCREWS

- A. Screw 6x60 RVS
2x - for fitting ceiling plate
- B. Screw 4x50 RVS
8x - for fitting System M and top pivot

SYSTEM M

TECHNICAL DRAWINGS

CEILING PLATE

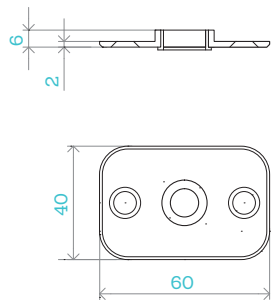

TOP PIVOT

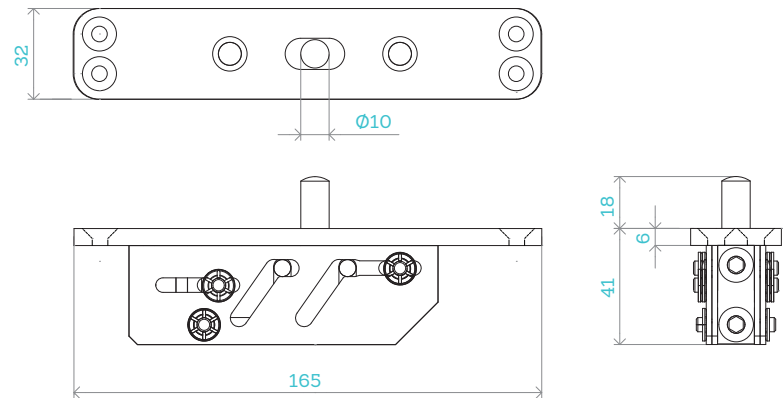

SYSTEM M

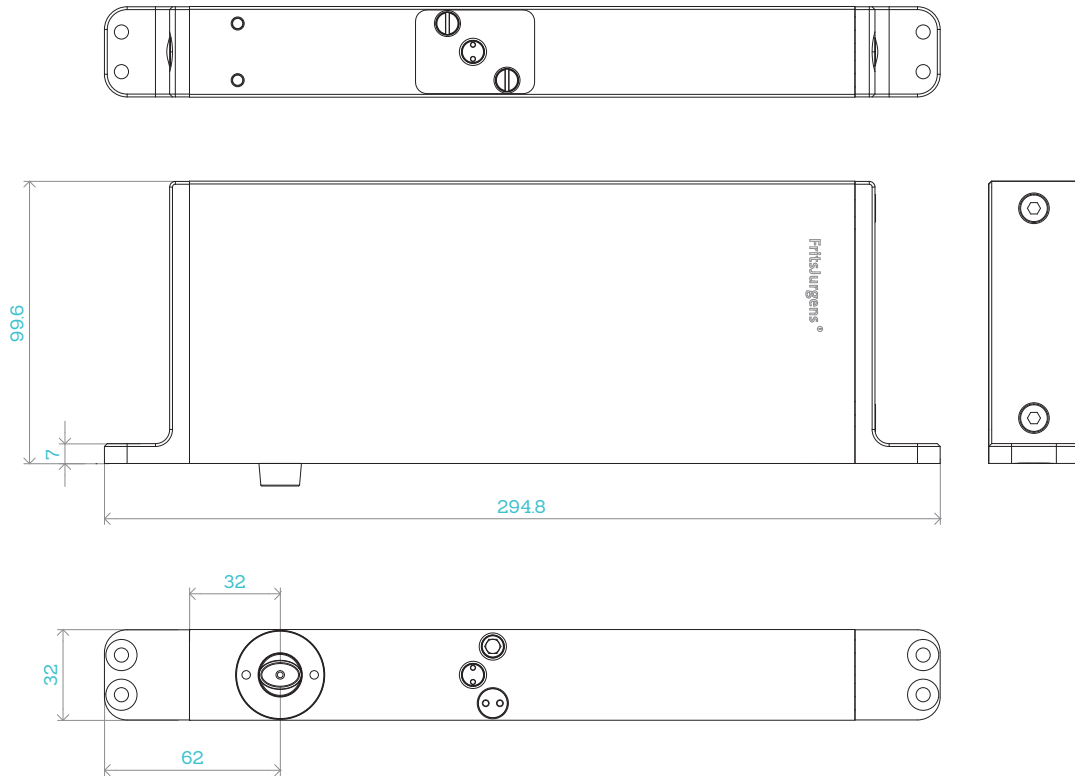

FLOORPLATE

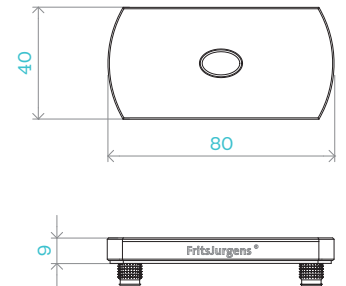

SYSTEM M MILLING DRAWINGS

TOP PIVOT

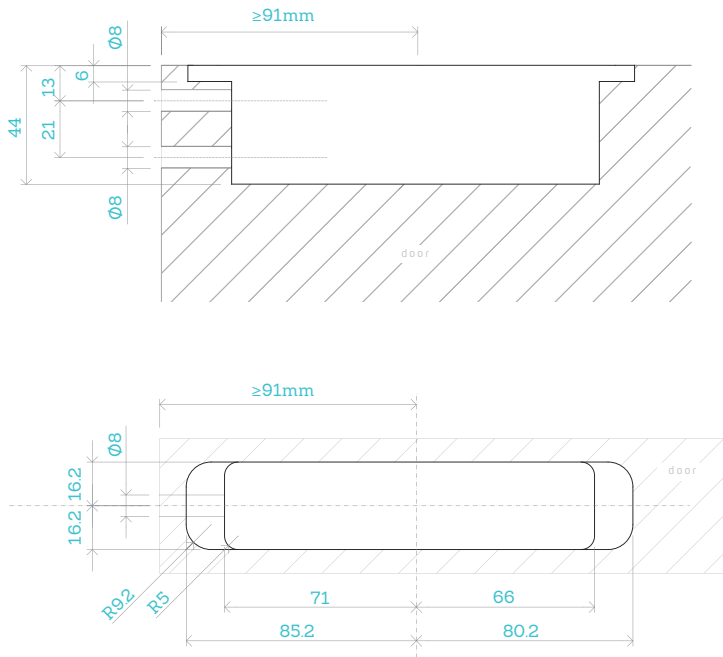

SYSTEM M

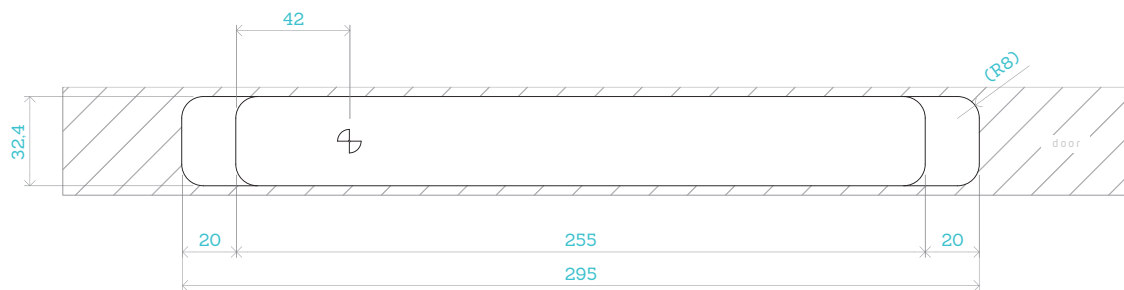
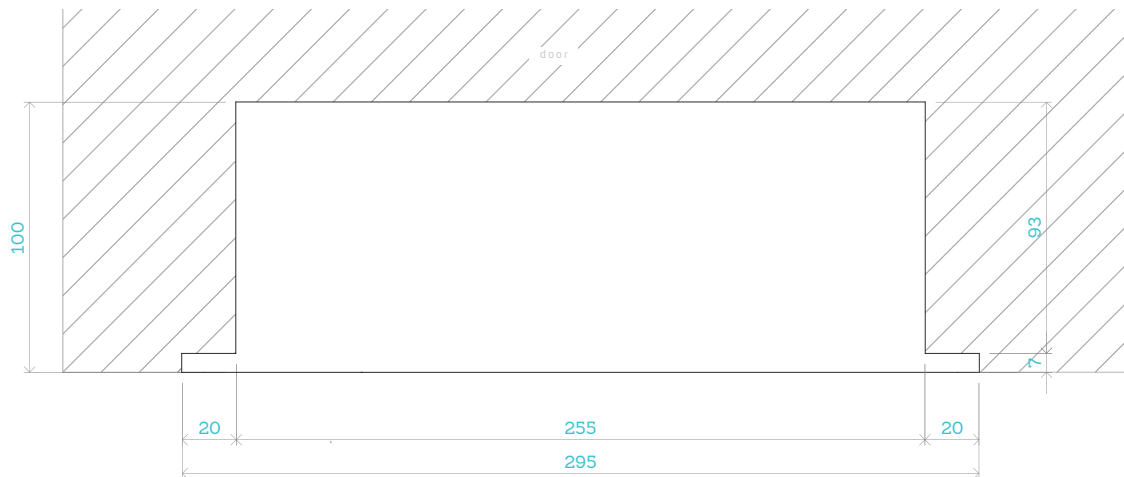

9 All dimensions in mm.

SYSTEM M

MOUNTING MANUAL

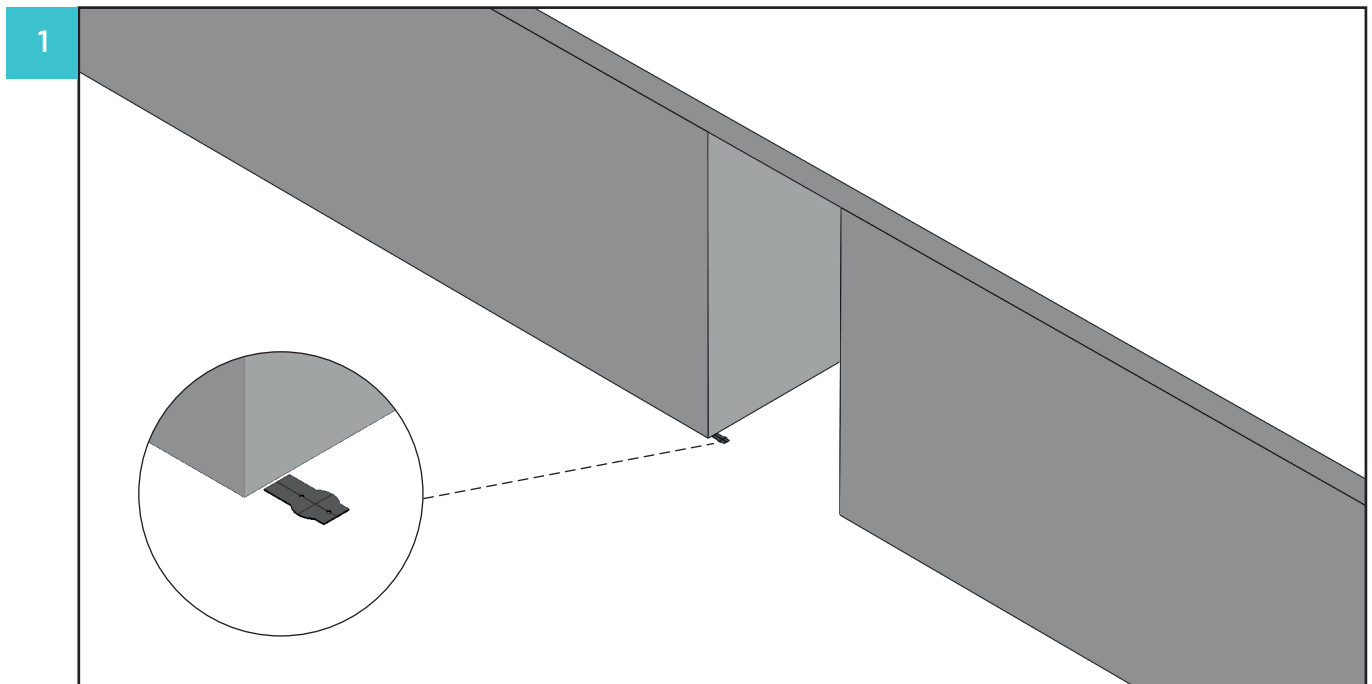

2

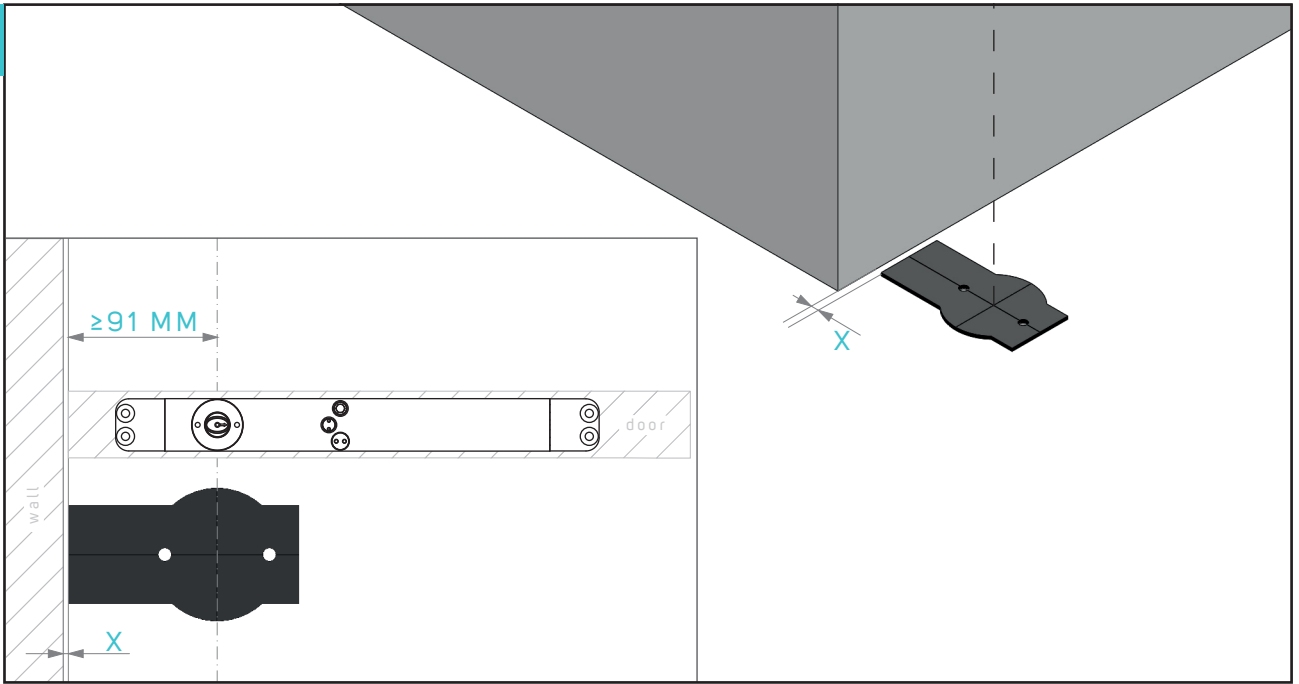

3

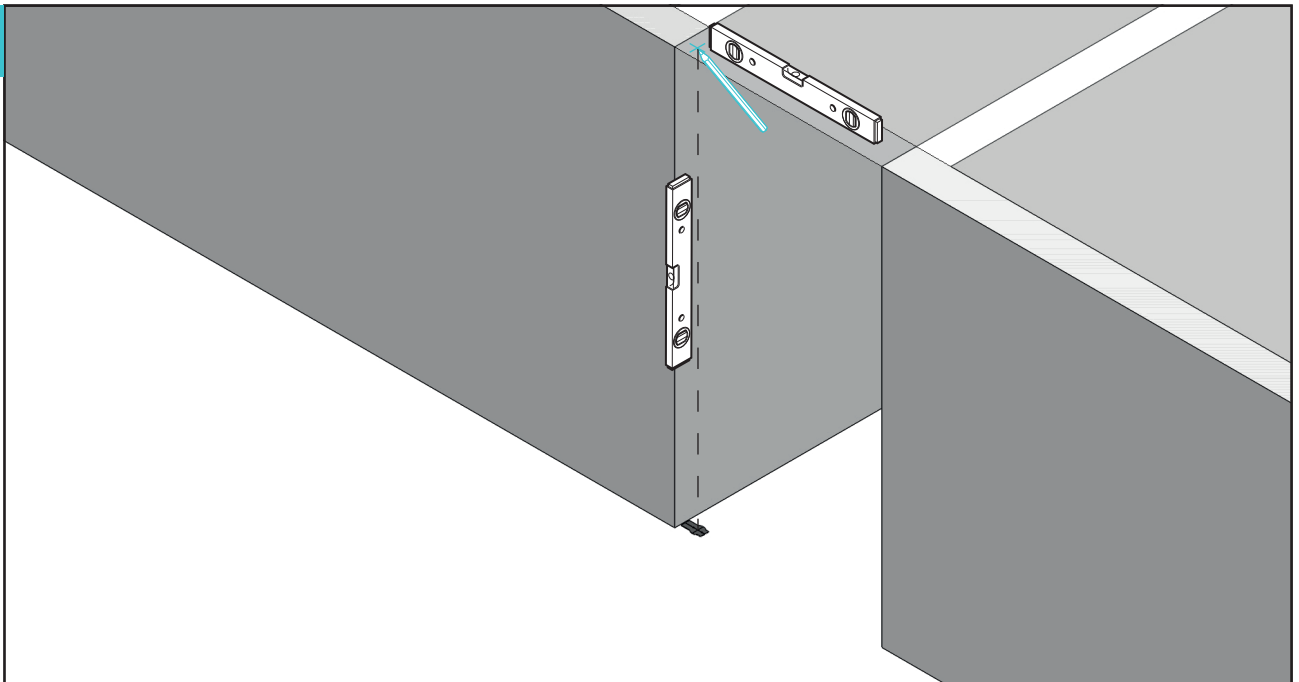

4

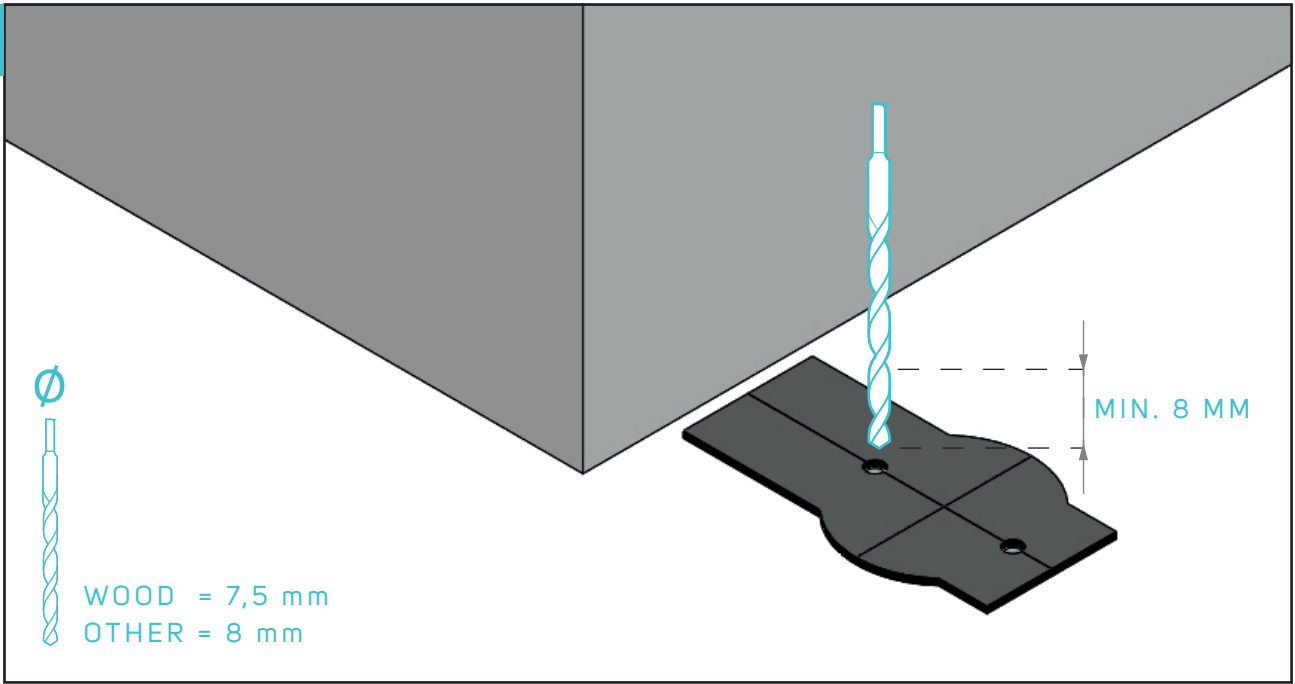

5

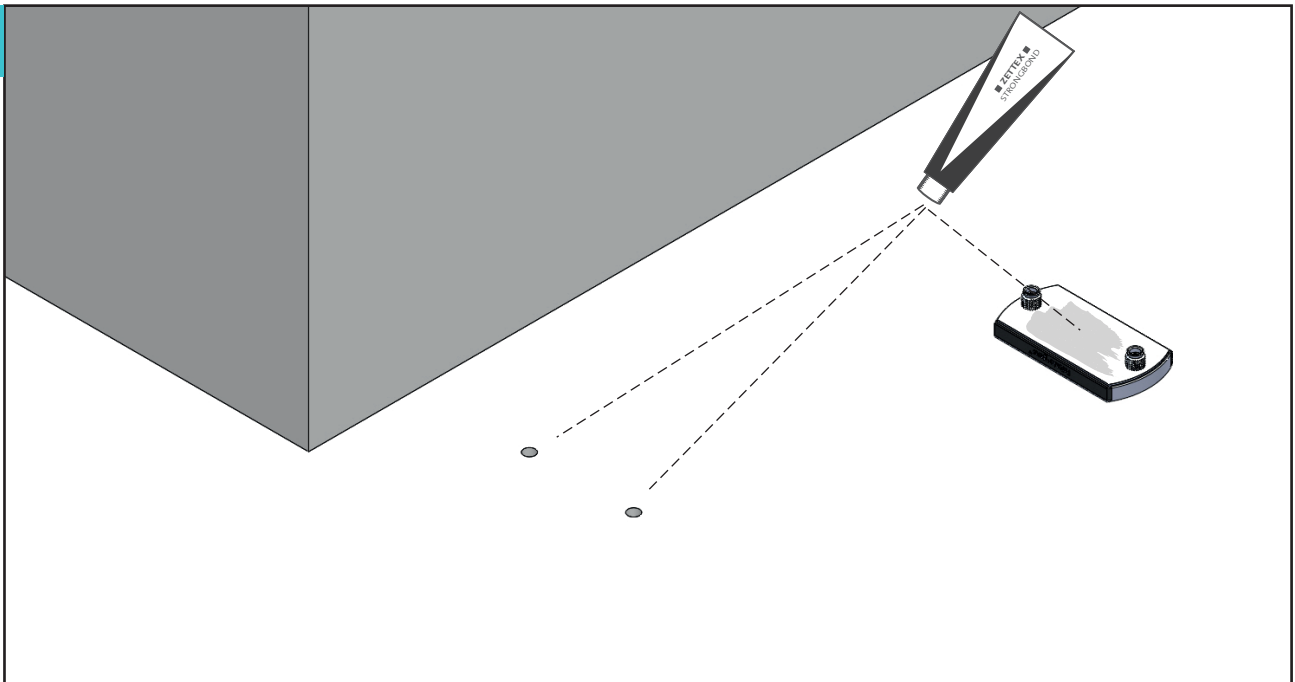



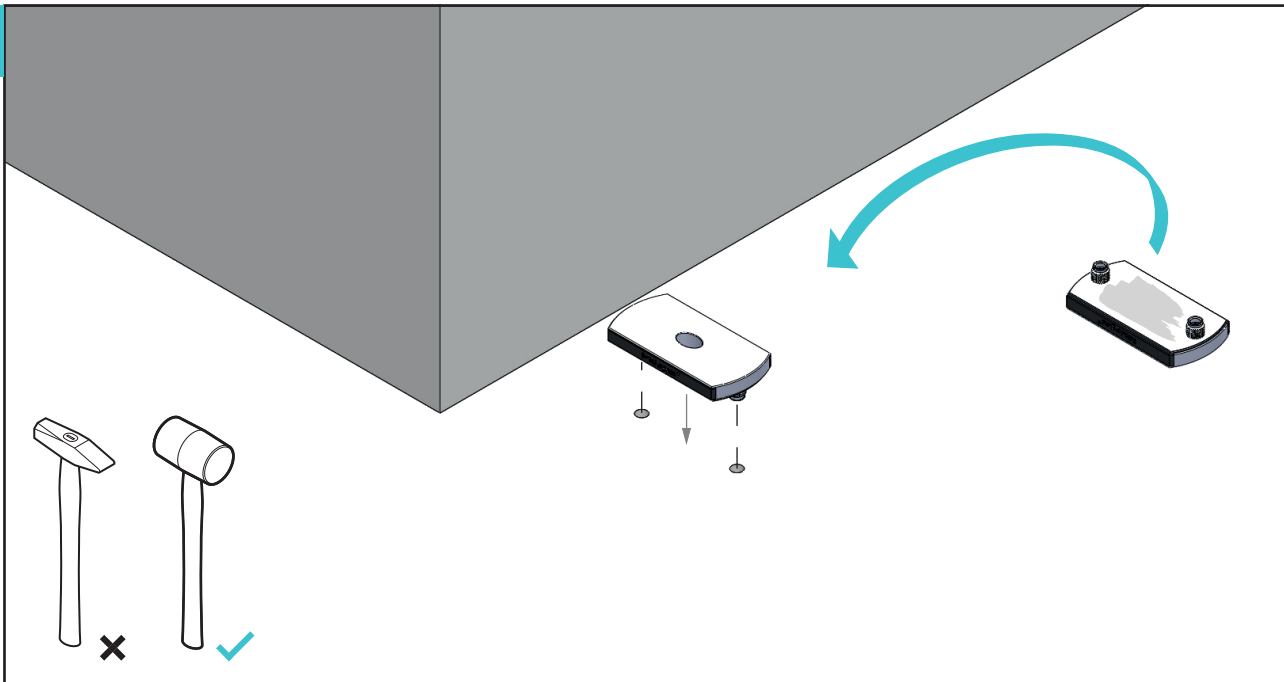

6

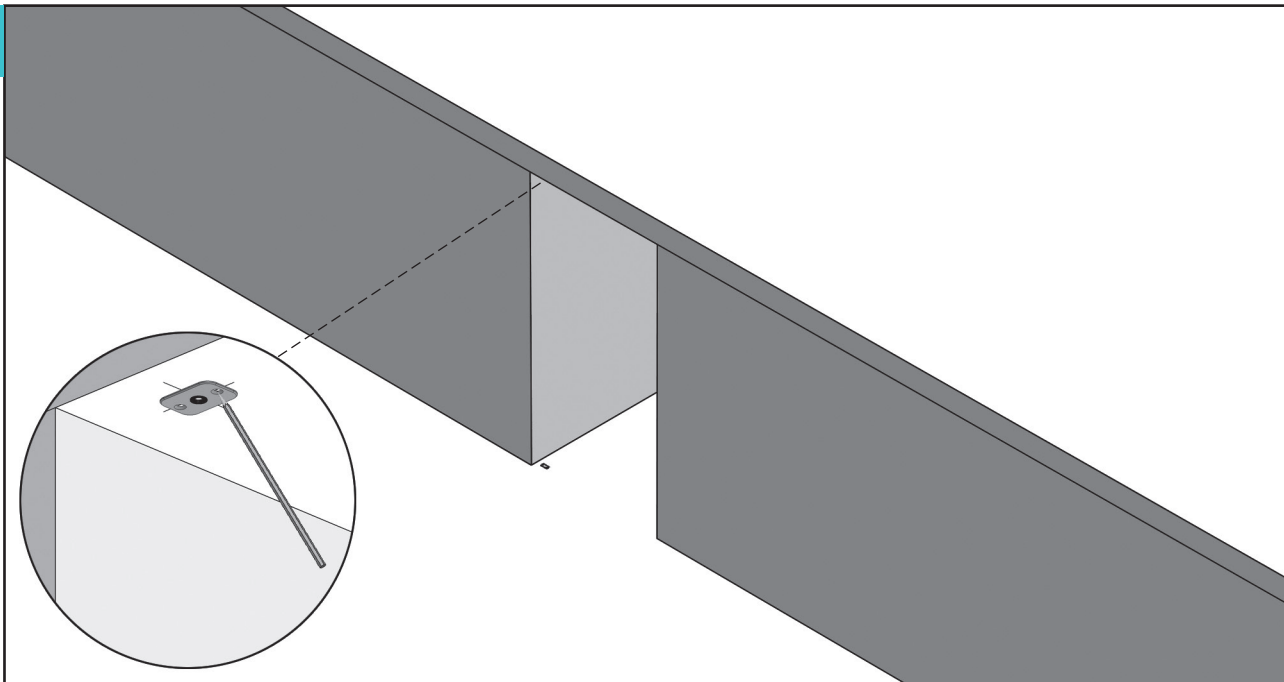

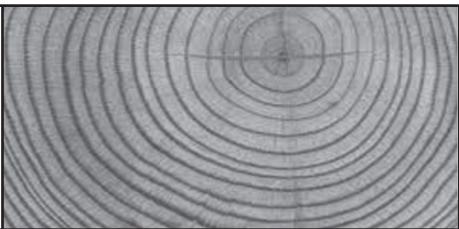
7

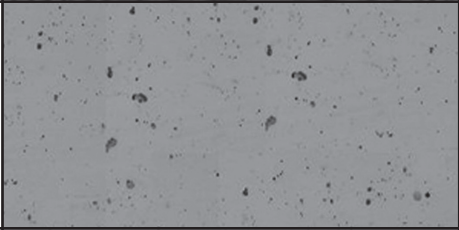
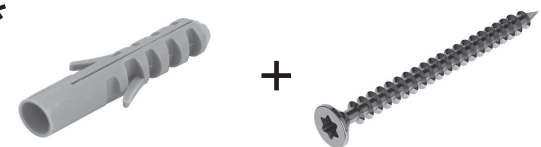

8	WOOD		
STONE		<p data-bbox="812 341 844 373">*</p> 	
STEEL		<p data-bbox="812 568 844 600">*</p>  <p data-bbox="958 682 1006 714">M5</p> <p data-bbox="1364 698 1461 747">* EXCL.</p>	

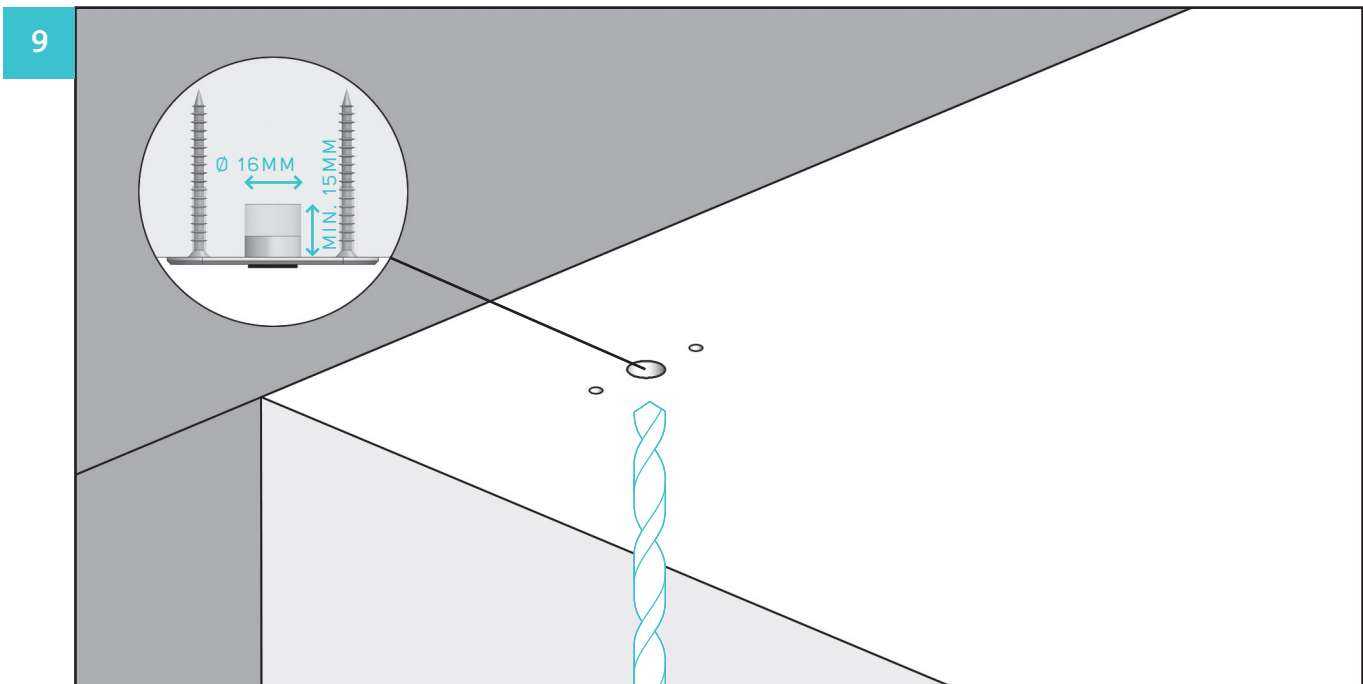

10

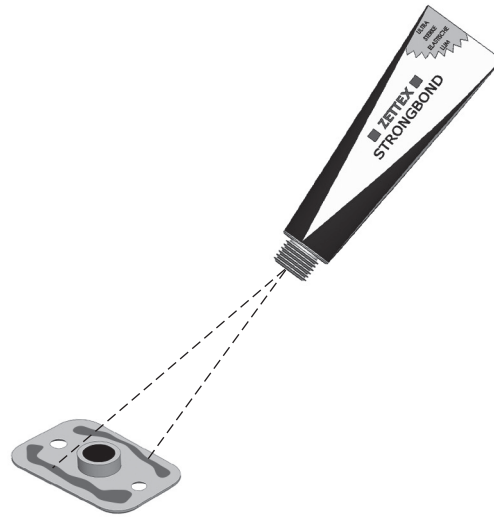

11

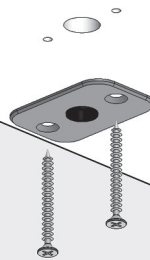

12

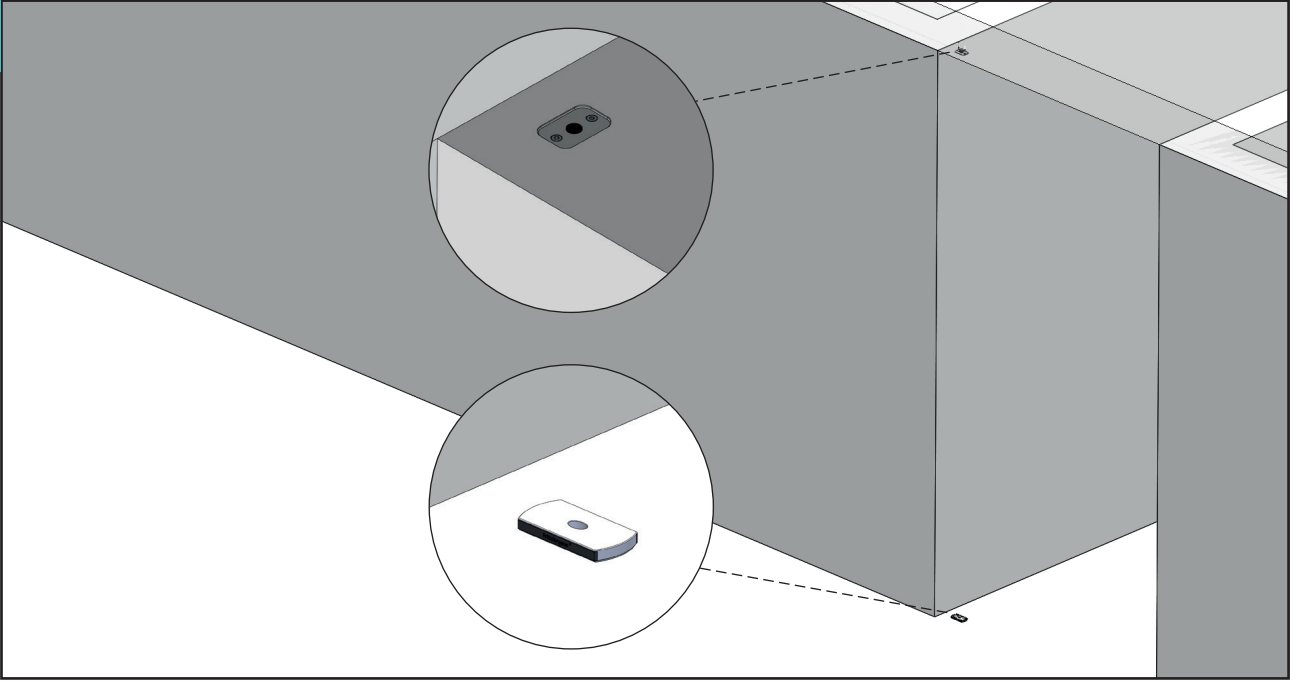

13

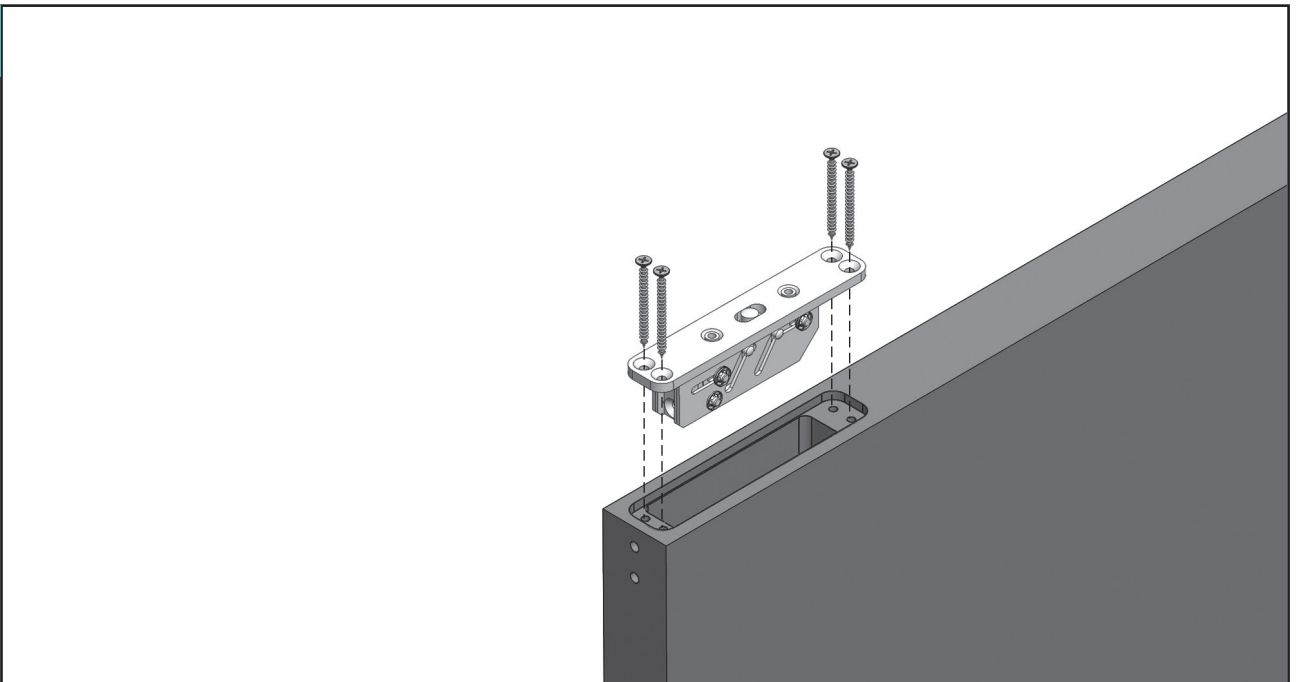

16

14

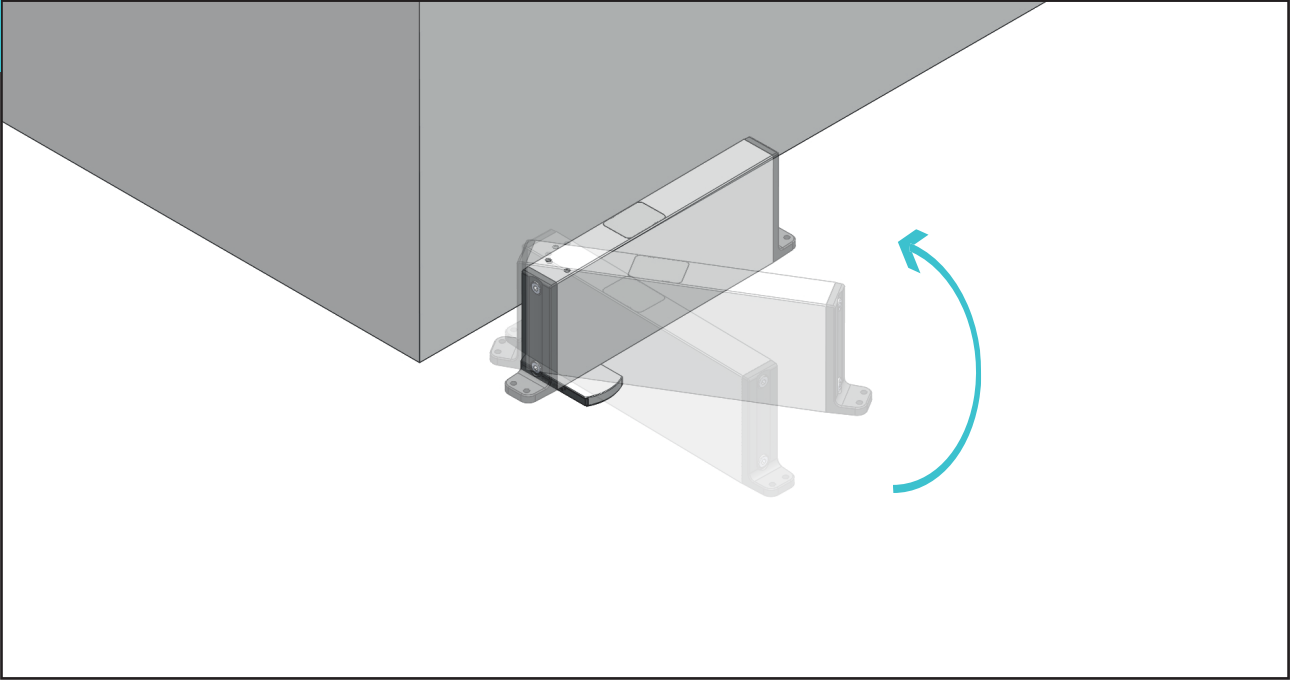

15

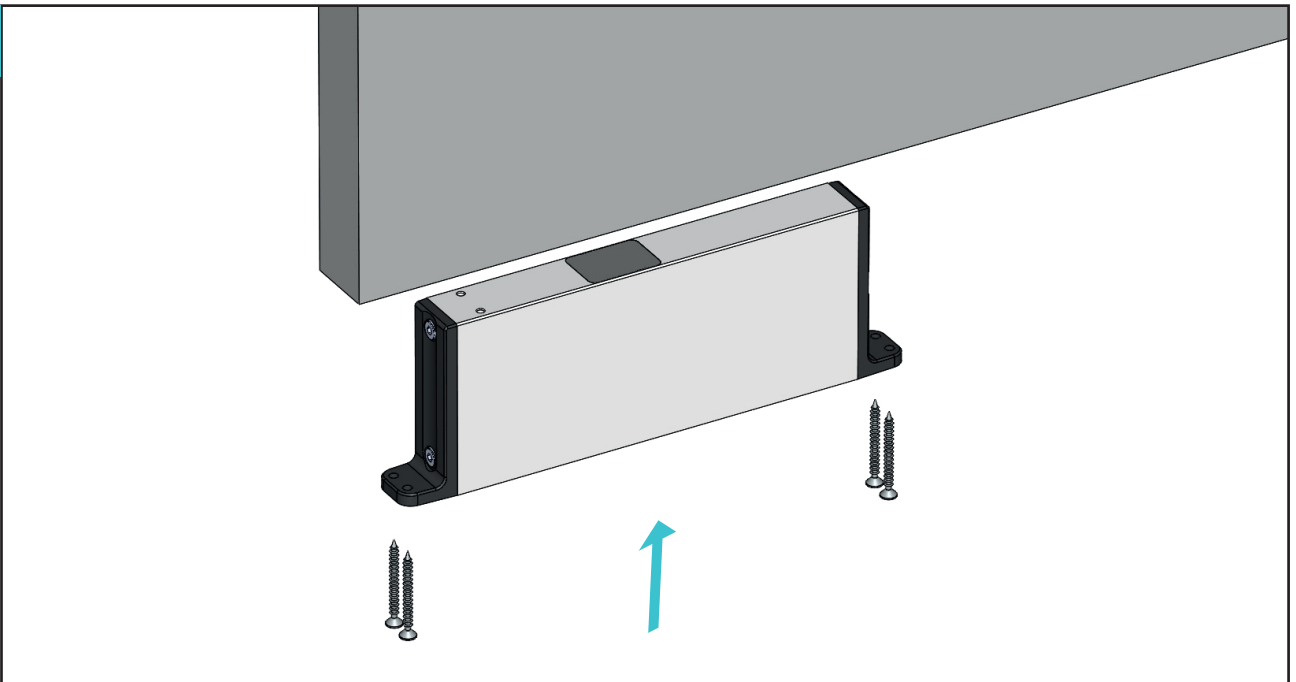

16

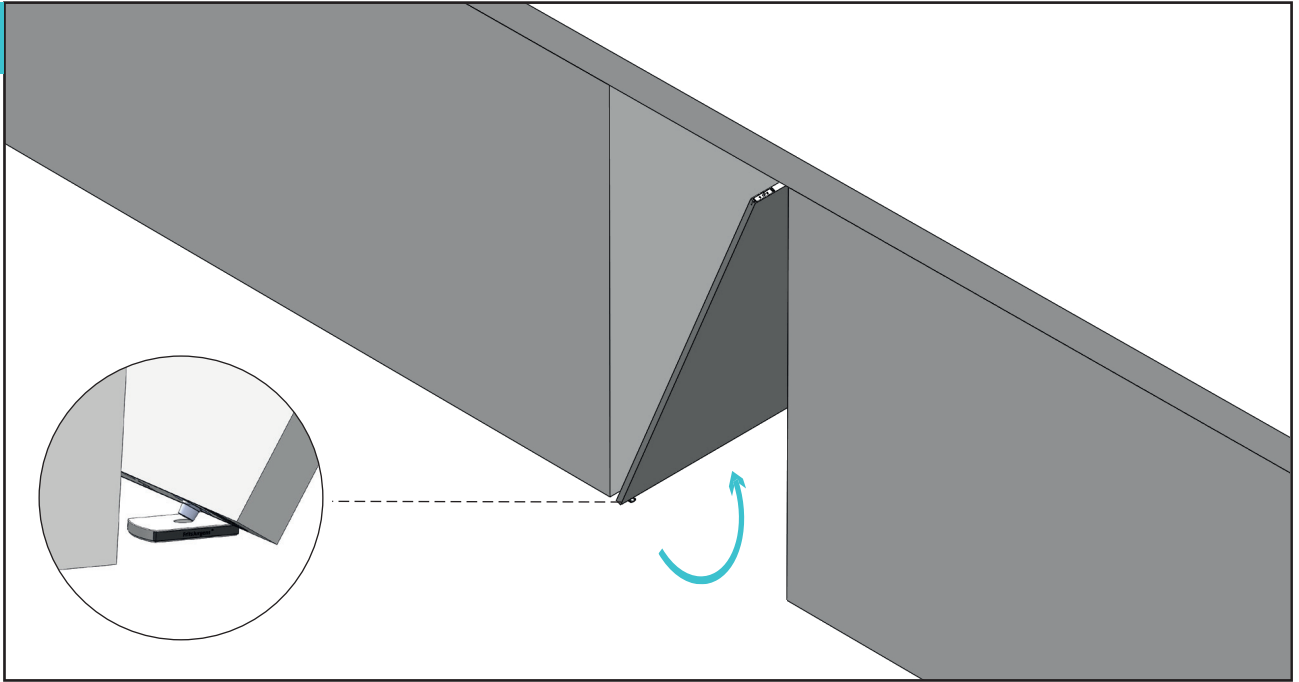

17

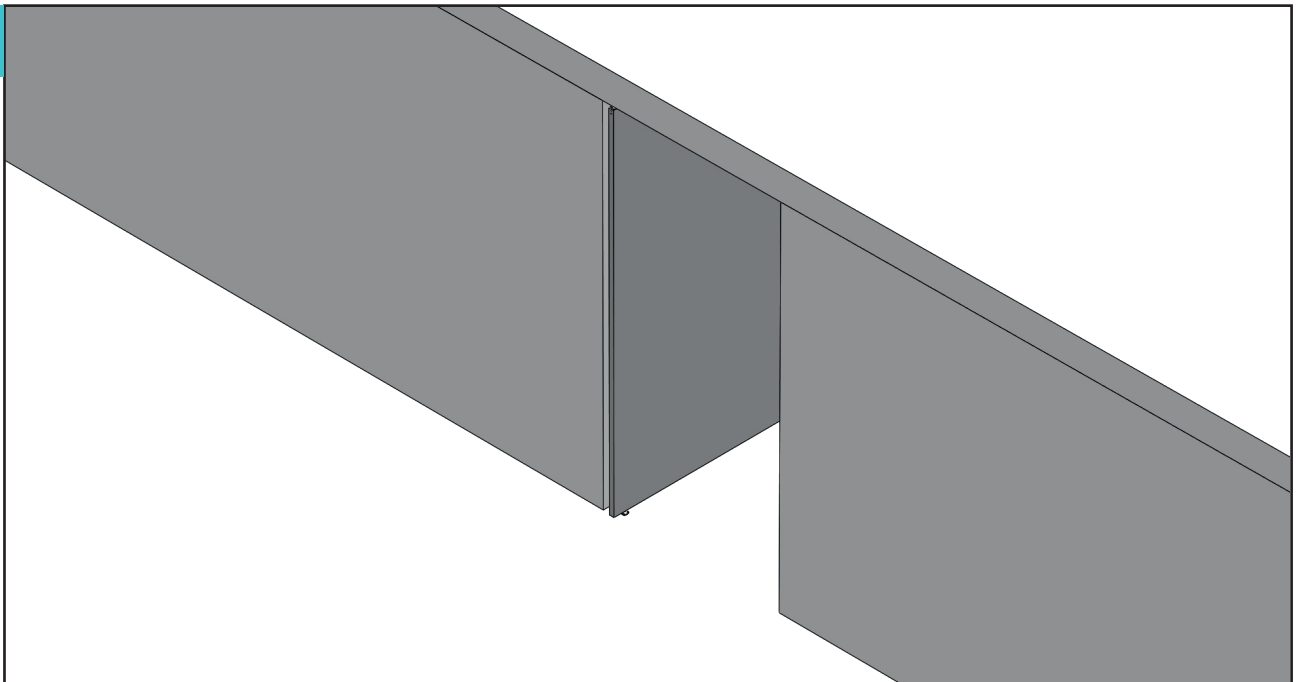

18

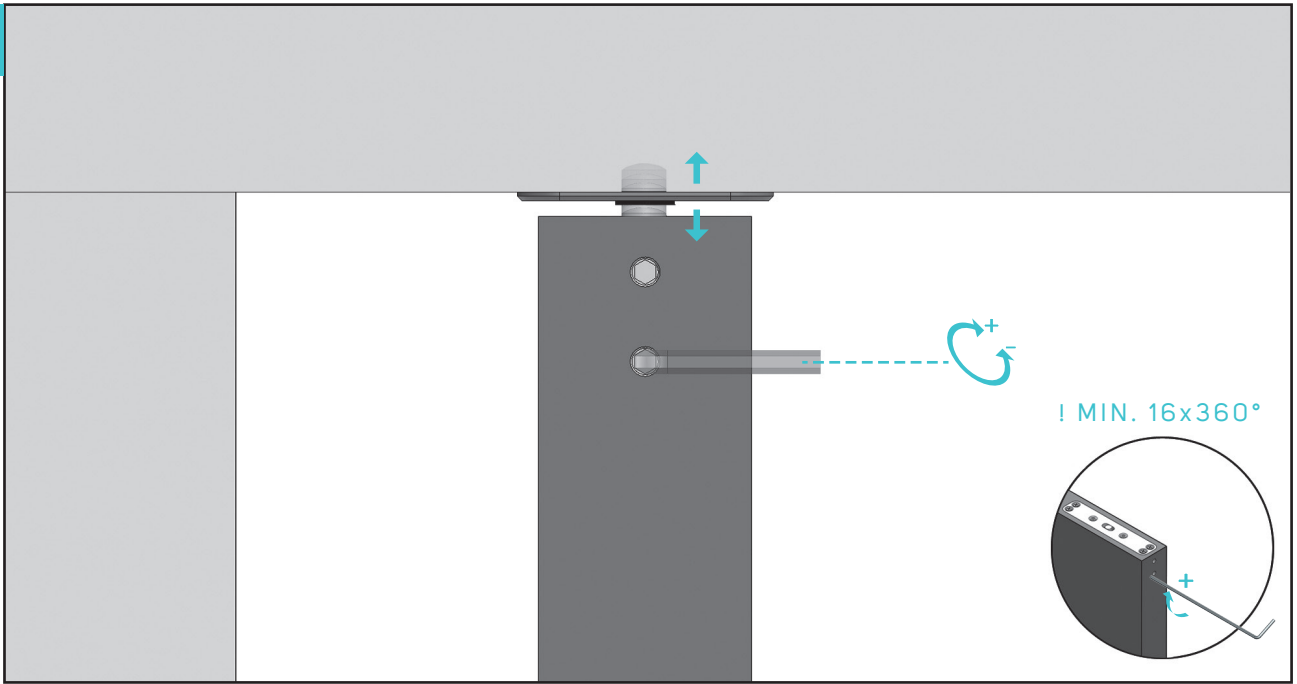

CLOSING SEAM SETTING

The closing seam can be adjusted using a 5mm hex key in the top hole.

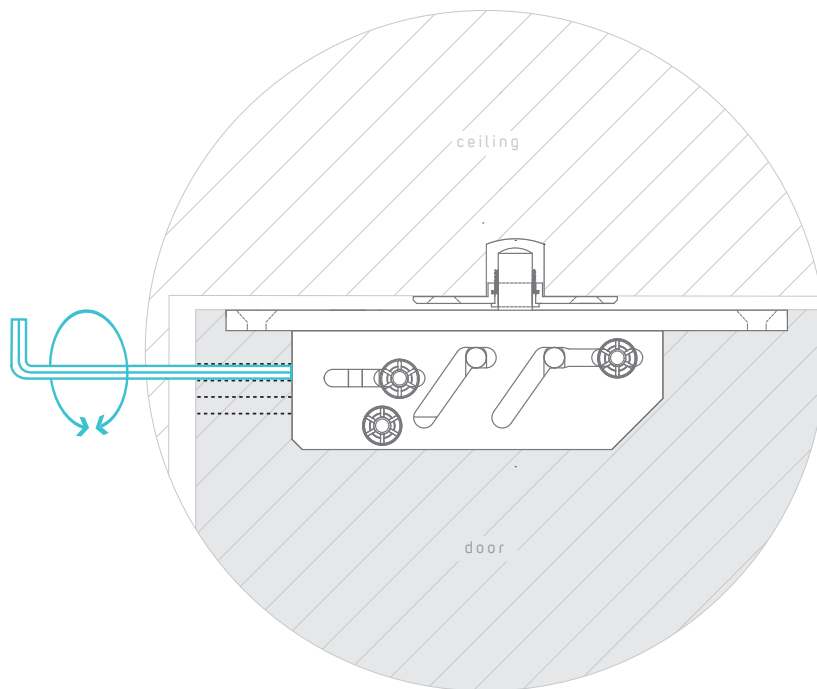

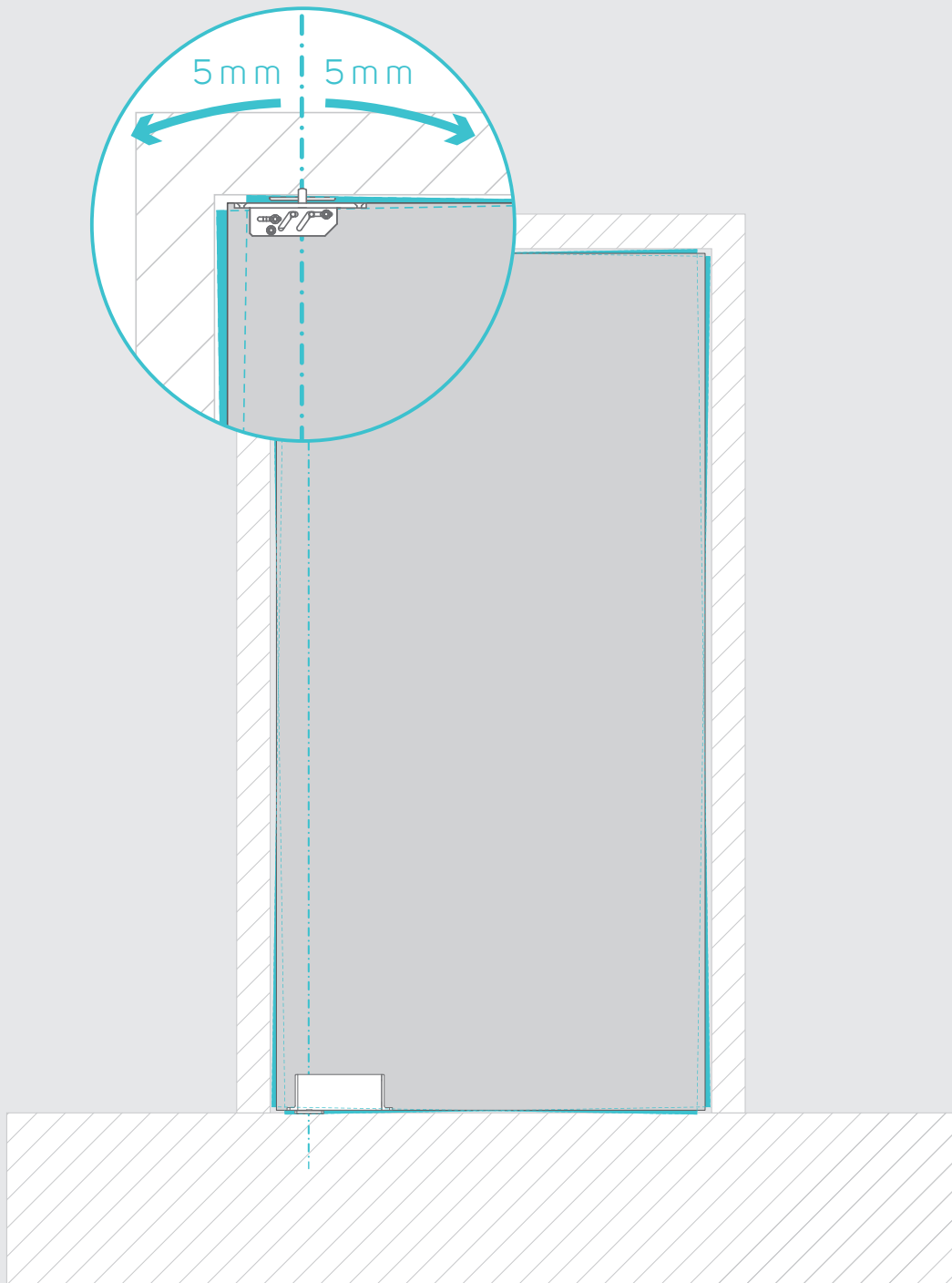

SETTING THE RADIAL POSITION

Remove the cap from the floorplate and adjust the angle of the door using a 3mm hex key.

Important: all 4 screws need to be loosened before setting the radius. Don't forget to tighten them again after adjusting.

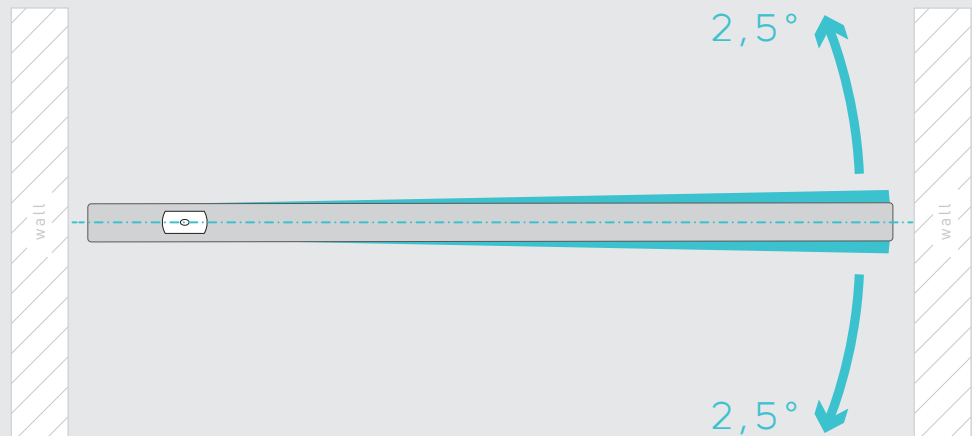
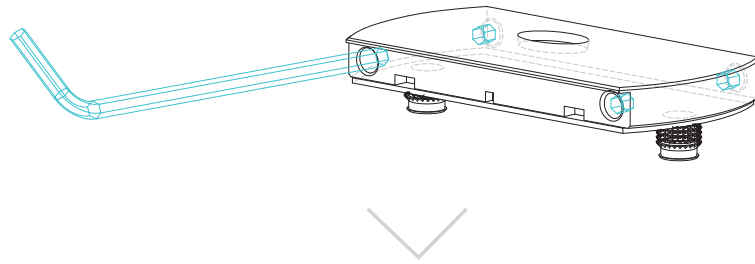

SETTING THE CLOSING SPEED

The closing speed can be adjusted using the included key.

To the right: more closing damping. To the left: less closing damping

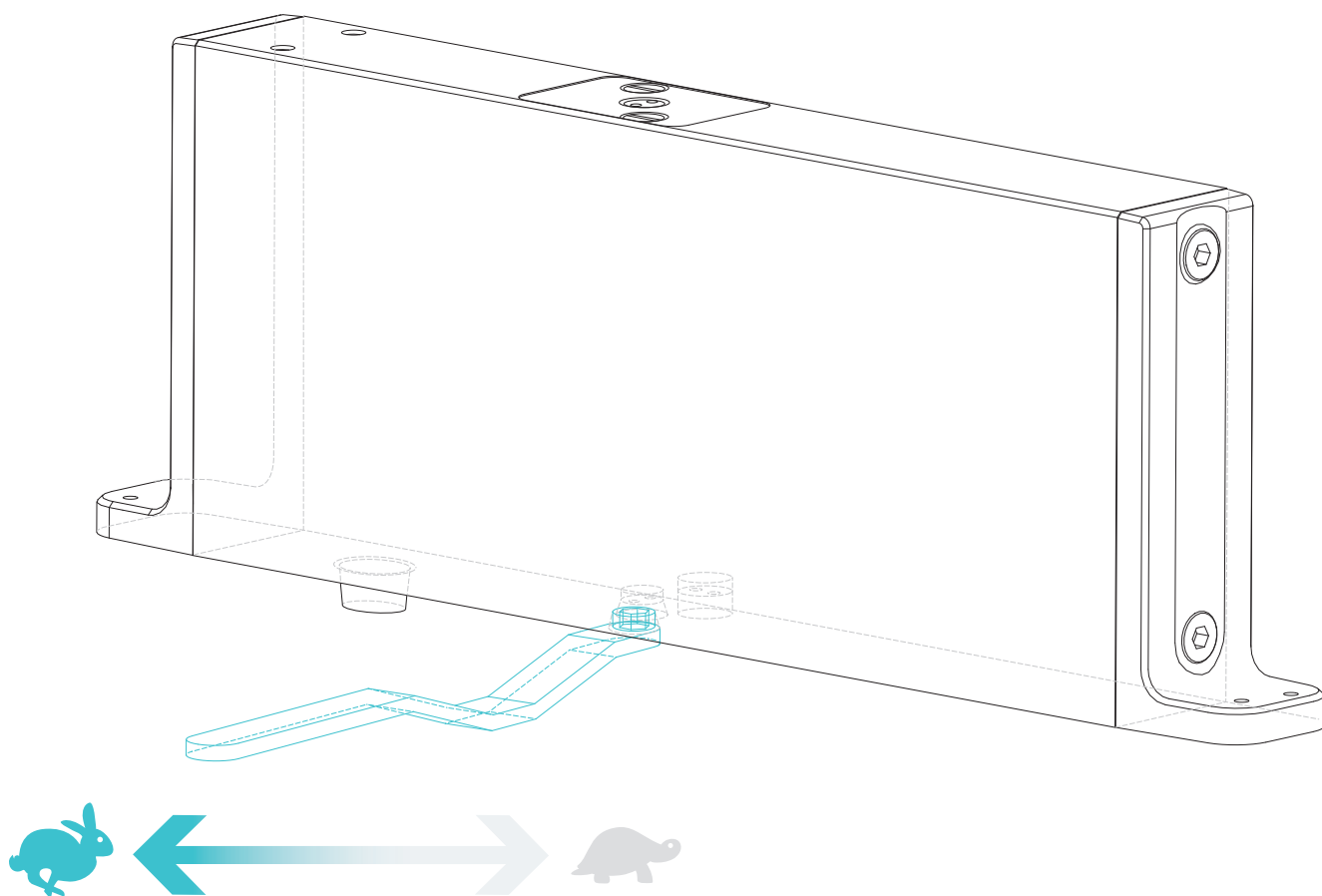

FRITSJURGENS INTERNATIONAL

+31 598 343 410

info@fritsjurgens.com

www.fritsjurgens.com