

# BASICS



## FORMANI STORIES

STORY MAASTRICHT, NEDERLAND   STORY MAASTRICHT, THE NETHERLANDS	518
STORY MAASTRICHT, NEDERLAND   STORY MAASTRICHT, THE NETHERLANDS	568

## DEURBESLAG | DOOR FITTINGS

DEURKRUKKEN   LEVER HANDLES	530
ACCESSOIRES DEURKRUKKEN   LEVER HANDLE ACCESSORIES	539

## RAAMBESLAG | WINDOW FITTINGS

RAAMBOOMPJES   CASEMENT FASTENERS	541
RAAMUITZETTERS   CASEMENT STAYS	541
DRAAIKIEPBESLAG   TILT AND TURN WINDOW HANDLES	541
KRUKESPAGNOLETTEN   ESPAGNOLETTE BOLTS	546

## VOORDEURBESLAG | FRONT DOOR FITTINGS

VOORDEURKNOPPEN   FRONT DOOR KNOBS	550
GREPEN   PULL HANDLES	552
VEILIGHEIDSCILINDERROZETTEN   SECURITY ESCUTCHEONS	553
VEILIGHEIDSSCHILDEN   SECURITY PLATES	554
BRIEFPLATEN   LETTER PLATES	556
BELDRUKKERS   BELL PUSHES	556
HUISNUMMERS   NUMERALS	556
DEURKLOPPERS   DOOR KNOCKER	559
MAILBOXES   MAILBOXES	560

## ACCESSOIRES | ACCESSORIES

SCHUIFDEURKOMMEN   FLUSH PULLS	561
MEUBELKNOPPEN   CABINET KNOBS	562
KNOPPEN   KNOBS	562
GLASDEURKNOPPEN   GLASS DOOR KNOBS	562
HAKEN   HOOKS	563
HEFSCHUIFDEURBESLAG   SLIDING DOOR HANDLES	563
DEURSTOPPEN   DOOR STOPS	564
GARDEROBEHAKEN   PROJECTING COAT RAILS	565
KLEDINGHANGERS   COAT HANGERS	565
SCHARNIEREN   HINGES	565
BASICS SOLIDE	567



# THE NETHER LANDS MAAAS TRICHT

LOCATION: MAASTRICHT, THE NETHERLANDS

OBJECT: OFFICES 'WITHUISHOF'

INTERIOR DESIGN: ROB STAHL, DIRK SCHOUTEN, MARC VOLA

PHOTOGRAPHY: TIJMEN BALLIEUX





**BASICS**  
LBII-19 LEVER HANDLE SATIN BLACK

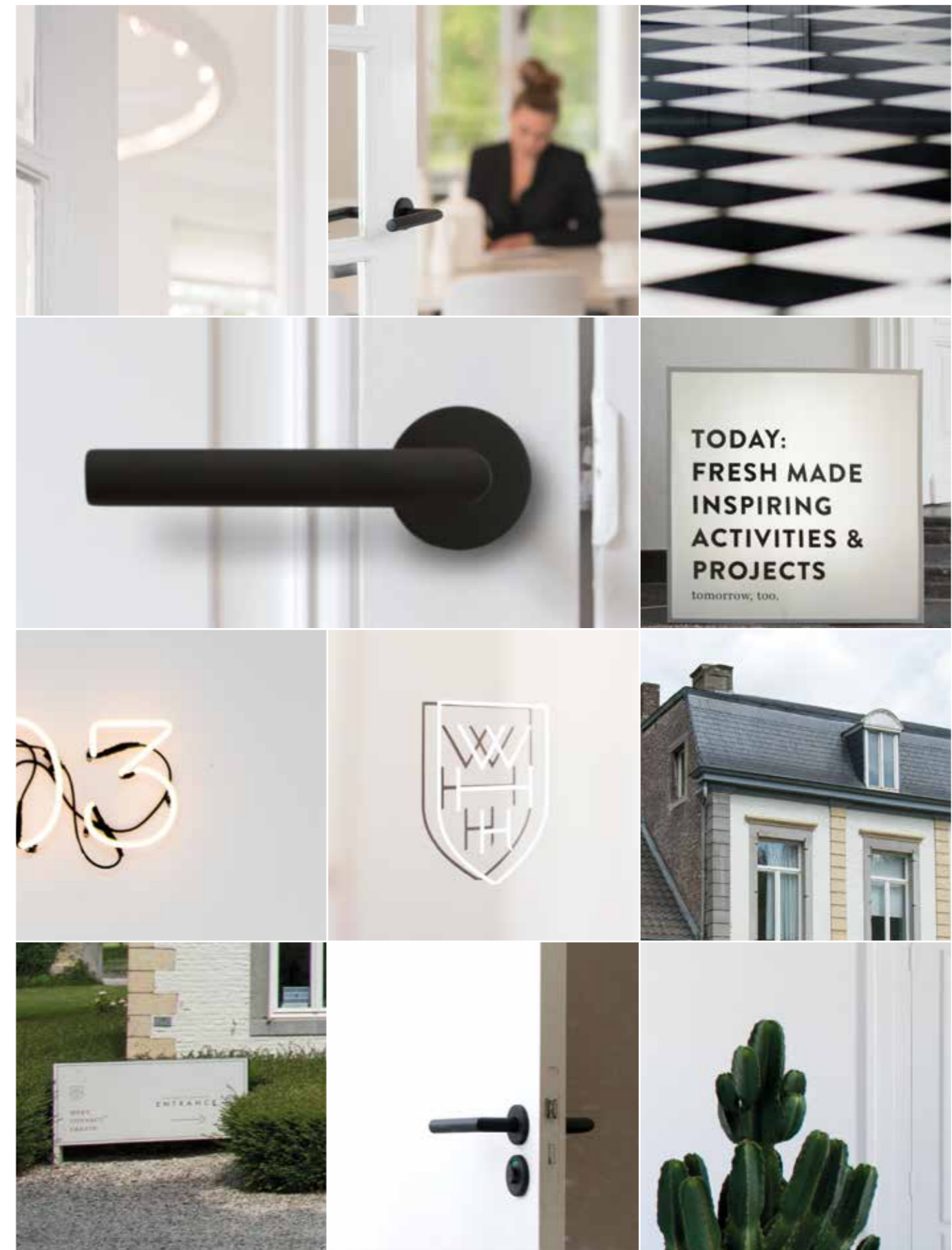



**BASICS**  
LBII-19 LEVER HANDLE SATIN BLACK

## ONCE UPON A TIME

Hoewel de oorsprong van Withuishof onbekend is, kent dit prachtige 17e-eeuwse object een rijke geschiedenis. Zo werd de hoeve in 1801 aangrijpend vernieuwd, nadat twee dochters van de familie Sleypen met twee zoons van de familie Schoenmaeckers trouwden. Een verbintenis die betekende dat het familiekapitaal van twee families samensmolt.

Although the origins of the Withuishof villa remain unknown, this stunning seventeenth-century building has a rich history. The estate underwent extensive renovation in 1801, after two Sleypen daughters married two Schoenmaeckers sons – a union that combined and consolidated the two family fortunes.

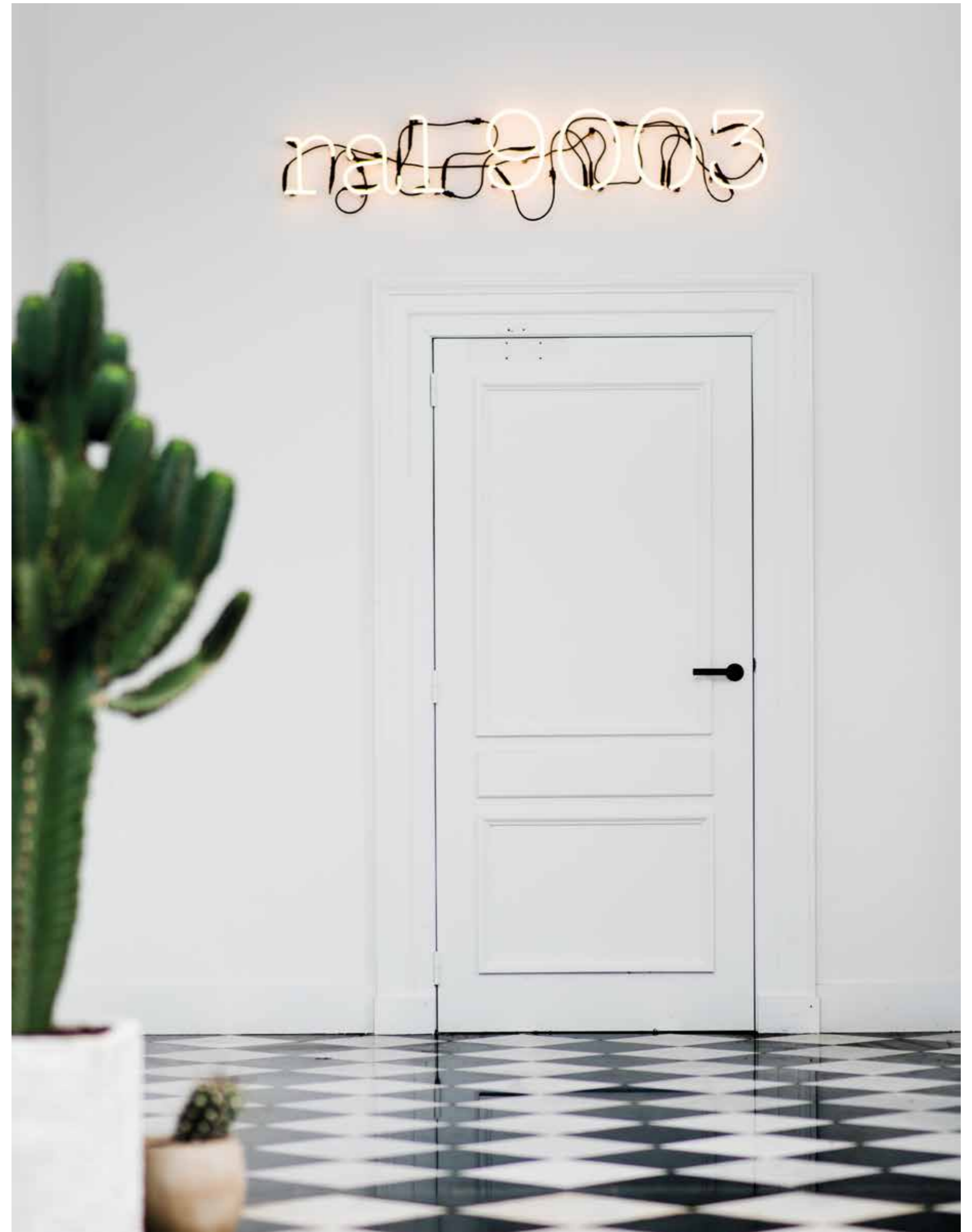





**BASICS**  
LBII-19 LEVER HANDLE SATIN BLACK



## FEEL THE SPIRIT

Van het rijke interieur, waarvan met zekerheid delen zijn ontworpen door de Maastrichtse architect Mathias Soiron, heeft maar weinig de tand des tijds doorstaan. Slechts enkele Lodewijk XVI-stijlelementen zijn bewaard gebleven. De combinatie van deze elementen met hedendaagse meubelen en eigentijdse objecten geeft de hoeve een niet te kopiëren look.

Unfortunately, much of the interior – parts of which were almost certainly designed by an architect from Maastricht; Mathias Soiron – did not stand the test of time. A few Louis XVI style elements are the only remaining artefacts. These elements, paired with the modern furniture and contemporary objects, lend the estate an air that cannot be equalled or rivalled.



**BASICS**  
LBII-19 LEVER HANDLE SATIN BLACK

## URBAN WORKSPACE

Het neoclassicistische karakter van dit rijksmonument is te danken aan verbouwingen aan het eind van de 19e eeuw. Deed het landhuis, aan de rand van Maastricht, in de vorige eeuw dienst als buitenverblijf voor de Zusters Ursulinen, toverde de huidige eigenaar het om tot een eigentijdse en inspirerende verzamelplek voor bedrijven.

The neoclassical design of this national heritage building is the result of renovations in the late nineteenth century. The country estate on the outskirts of Maastricht, which once served as a holiday home for the Order of the Ursulines, was transformed by the current owner into a contemporary and inspiring meeting place for companies.

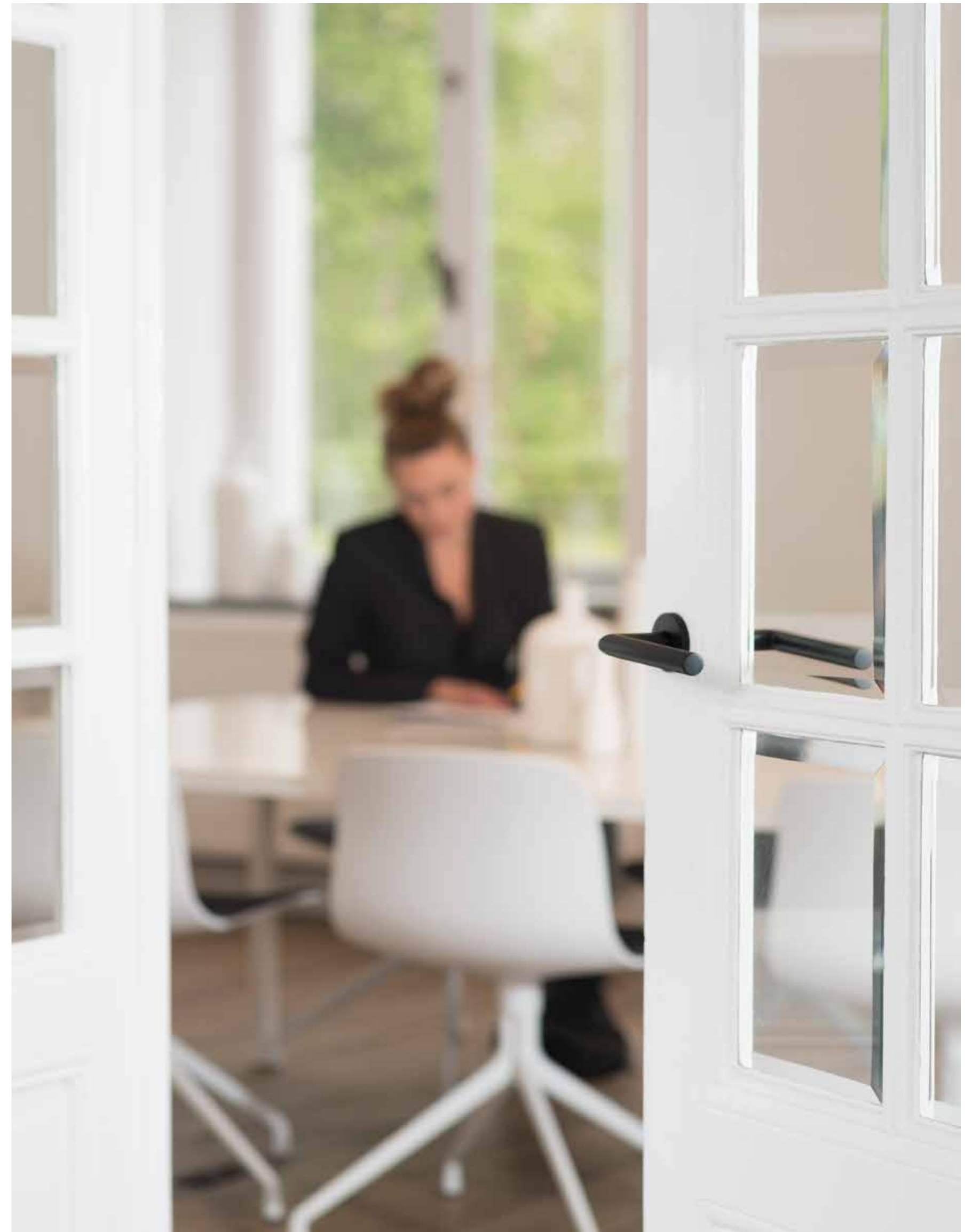

A man's  
manners  
are a mirror  
in which he  
shows his  
portrait.



**BASICS**  
LBII-19 LEVER HANDLE SATIN BLACK  
LBWC50 PRIVACY SET SATIN BLACK

## CRISP AND CLEAR DOORWARE

De zwarte doorware uit de Basics serie past bij het schaakspel van de zwart witte vloeren. De no-nonsense vormgeving van de doorware laat de eeuwenoude schoonheid van het gebouw spreken en sluit naadloos aan bij het eigentijdse karakter. In deze setting ontpopt de Basics serie een veelzijdigheid die te vergelijken is met de verscheidenheid van de in Withuishof gevestigde bedrijven.

The black door fittings from the Basics series complement the black-and-white checked floors beautifully. The clean design of the door fittings showcases the centuries-old beauty of the building and fits seamlessly with the contemporary character. In this setting, the Basics series offers a versatility that mirrors the diversity of the companies housed within.



# BASICS

DEURBESLAG | DOOR FITTINGS

LBI-16



mat roestvast staal  
satin stainless steel

deurkruk vast-draaibaar met metalen onderconstructie geveerd op rozet

sprung lever handle attached to rose with metal sub-rose

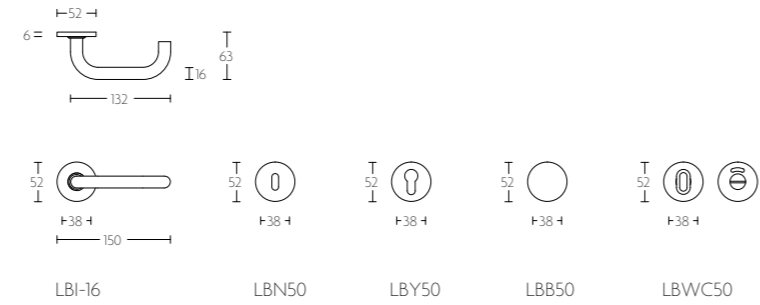

deurkruk vast-draaibaar met metalen onderconstructie geveerd op rozet

sprung lever handle attached to rose with metal sub-rose

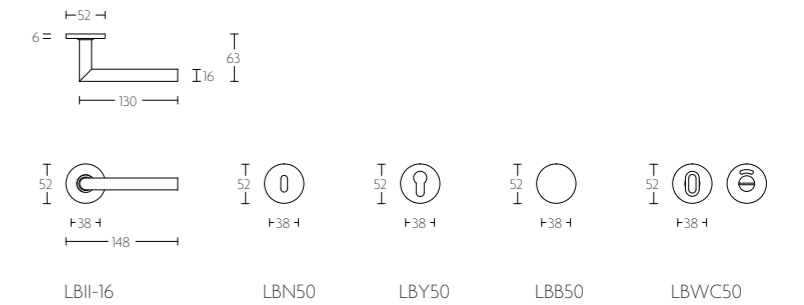

LBII-16



mat roestvast staal  
satin stainless steel

LBI-19



mat roestvast staal  
satin stainless steel

PVD mat roestvast staal  
PVD satin stainless steel

gepolijst roestvast staal  
polished stainless steel

deurkruk vast-draaibaar met metalen onderconstructie geveerd op rozet tevens EN1906 klasse 3 versie verkrijgbaar

sprung lever handle attached to rose with metal sub-rose also EN1906 class 3 version available

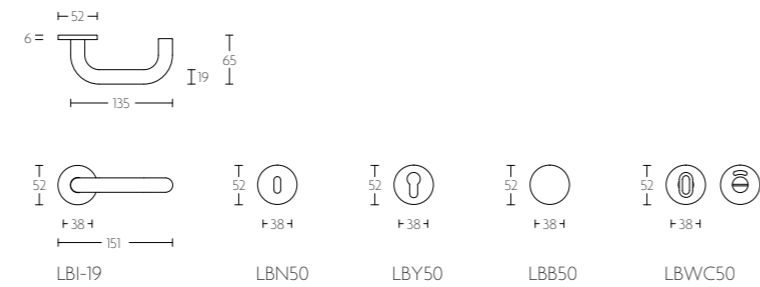

deurkruk vast-draaibaar met metalen onderconstructie geveerd op rozet tevens EN1906 klasse 3 versie verkrijgbaar

sprung lever handle attached to rose with metal sub-rose also EN1906 class 3 version available

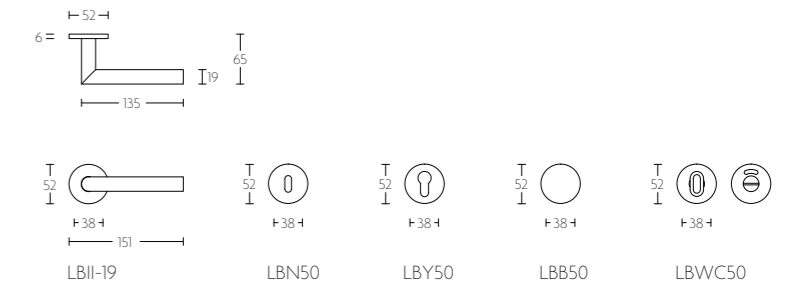

LBII-19



mat roestvast staal  
satin stainless steel



PVD mat roestvast staal  
PVD satin stainless steel



gepolijst roestvast staal  
polished stainless steel



mat zwart  
satin black



PVD gunmetal  
PVD gunmetal



PVD mat goud  
PVD satin gold



PVD gepolijst koper  
PVD polished copper

LBI-19P13



mat roestvast staal  
satin stainless steel

PVD mat roestvast staal  
PVD satin stainless steel

gepolijst roestvast staal  
polished stainless steel

deurkruk vast-draaibaar met metalen onderconstructie geveerd op schild

sprung lever handle attached to plate with metal sub-rose

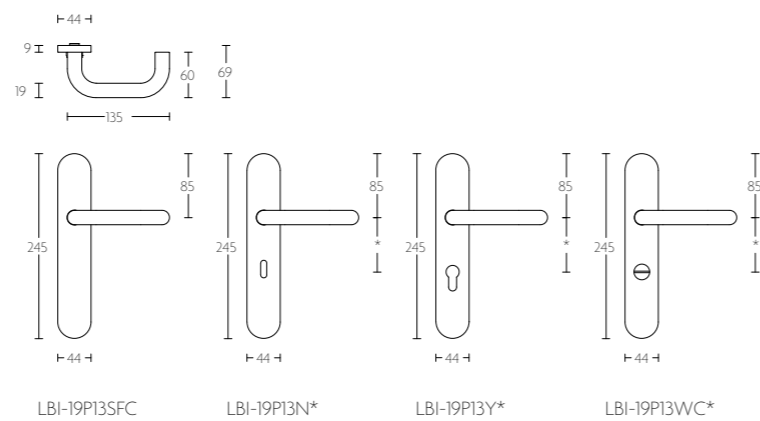

\* afstand opgeven bij bestelling  
\* state distance on order

# BASICS







DEURBESLAG | DOOR FITTINGS

# BASICS

DEURBESLAG | DOOR FITTINGS

## LBII-19P13



-  mat roestvast staal  
satin stainless steel
-  PVD mat roestvast staal  
PVD satin stainless steel
-  gepolijst roestvast staal  
polished stainless steel
-  mat zwart  
satin black
-  PVD gunmetal  
PVD gunmetal
-  PVD mat goud  
PVD satin gold
-  PVD gepolijst koper  
PVD polished copper

deurkruk vast-draaibaar  
met metalen onderconstructie  
geveerd op schild

sprung lever handle  
attached to plate  
with metal sub-rose

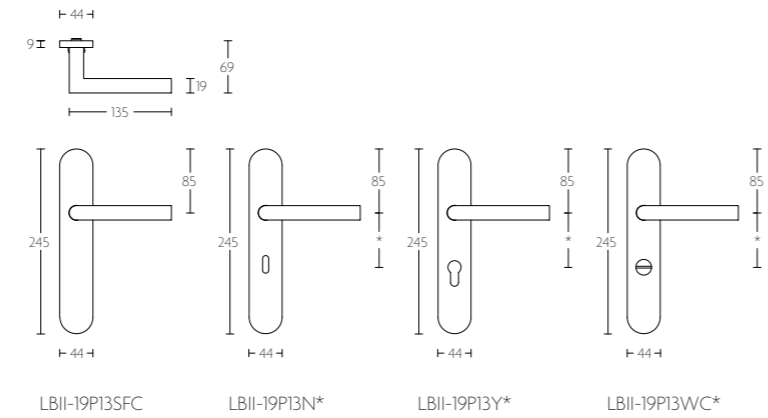

\* afstand opgeven bij bestelling  
\* state distance on order

# BASICS

DEURBESLAG | DOOR FITTINGS

## LBIII-16



mat roestvast staal  
satin stainless steel

deurkruk vast-draaibaar  
met metalen onderconstructie  
geveerd op rozet

sprung lever handle  
attached to rose  
with metal sub-rose

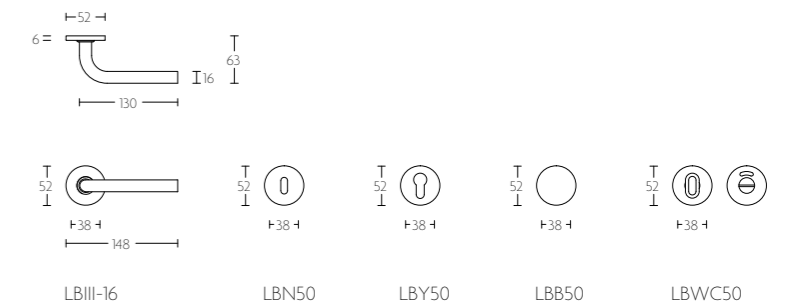

## LBII-19Q50



mat roestvast staal  
satin stainless steel



gepolijst roestvast staal  
polished stainless steel



mat zwart  
satin black

deurkruk op rozet  
met metalen onderconstructie  
ongeveerd

unsprung lever handle  
attached to rose  
with metal sub-rose

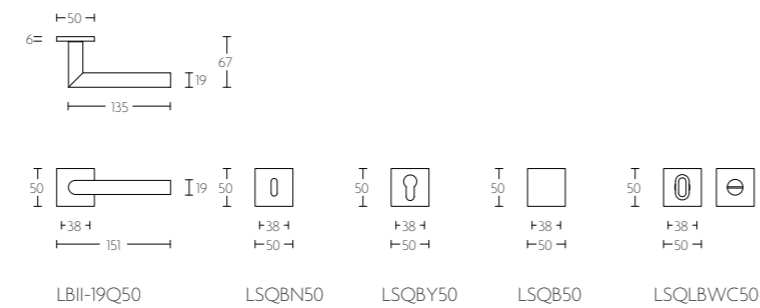

## LBIII-19



mat roestvast staal  
satin stainless steel



PVD mat roestvast staal  
PVD satin stainless steel



gepolijst roestvast staal  
polished stainless steel



mat zwart  
satin black

deurkruk vast-draaibaar  
met metalen onderconstructie  
geveerd op rozet  
tevens EN1906 klasse 3 versie verkrijgbaar

sprung lever handle  
attached to rose  
with metal sub-rose  
also EN1906 class 3 version available

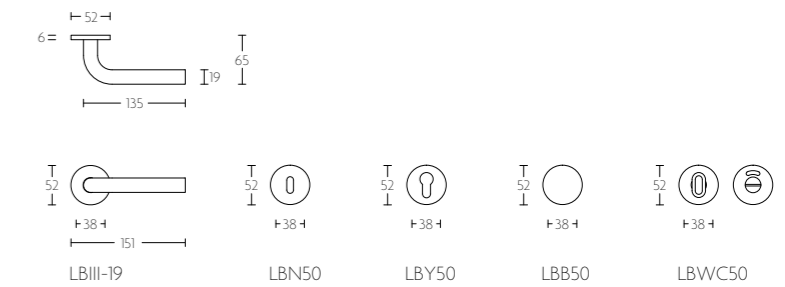

## LBII-19P236



mat roestvast staal  
satin stainless steel



gepolijst roestvast staal  
polished stainless steel



mat zwart  
satin black

deurkruk vast-draaibaar,  
ngeveerd op schild, een zijde met  
en een zijde zonder zichtbare bevestiging

unsprung lever handle  
attached to plate  
fixings visible on one side only

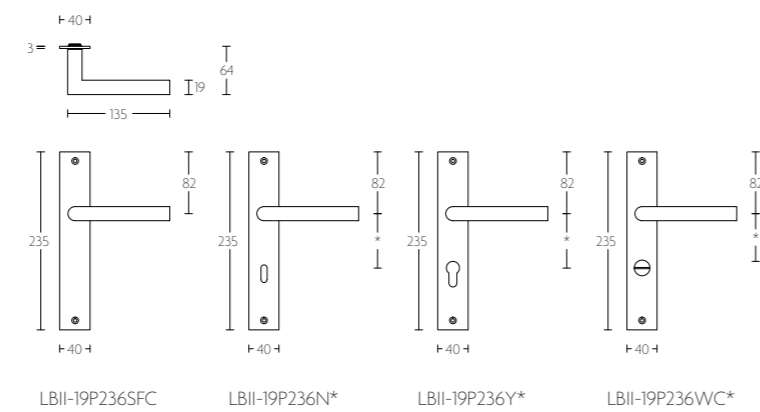

\* afstand opgeven bij bestelling  
\* state distance on order



PVD gunmetal  
PVD gunmetal



PVD mat goud  
PVD satin gold



PVD gepolijst koper  
PVD polished copper









# BASICS

DEURBESLAG | DOOR FITTINGS

LBIII-19P13



-  mat roestvast staal  
satin stainless steel
-  PVD mat roestvast staal  
PVD satin stainless steel
-  gepolijst roestvast staal  
polished stainless steel
-  mat zwart  
satin black
-  PVD gunmetal  
PVD gunmetal
-  PVD mat goud  
PVD satin gold
-  PVD gepolijst koper  
PVD polished copper

deurkruk vast-draaibaar  
met metalen onderconstructie  
geveerd op schild

sprung lever handle  
attached to plate  
with metal sub-rose

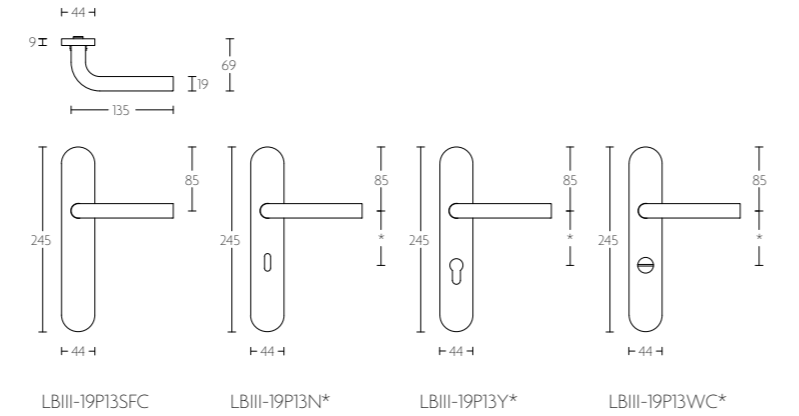

\* afstand opgeven bij bestelling  
\* state distance on order

# BASICS

DEURBESLAG | DOOR FITTINGS

LBVII-19



mat roestvast staal  
satin stainless steel



mat zwart  
satin black



PVD gunmetal  
PVD gunmetal



PVD mat goud  
PVD satin gold



PVD gepolijst koper  
PVD polished copper

deurkruk vast-draaibaar  
met metalen onderconstructie  
geveerd op rozet  
tevens EN1906 klasse 3 versie verkrijgbaar

sprung lever handle  
attached to rose  
with metal sub-rose  
also EN1906 class 3 version available

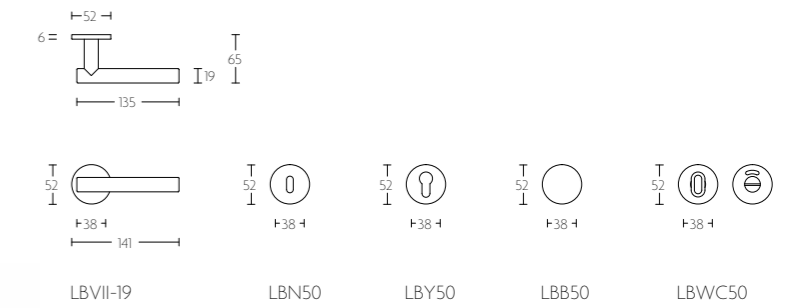

LBIV-19



mat roestvast staal  
satin stainless steel

deurkruk vast-draaibaar  
met metalen onderconstructie  
geveerd op rozet  
tevens EN1906 klasse 3 versie verkrijgbaar

sprung lever handle  
attached to rose  
with metal sub-rose  
also EN1906 class 3 version available

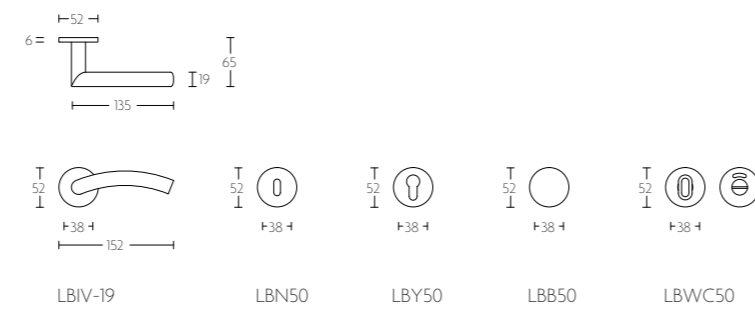

LBVII-19Q50



mat roestvast staal  
satin stainless steel



mat zwart  
satin black

deurkruk met metalen  
onderconstructie  
ongeveerd op rozet

unsprung lever handle  
attached to rose  
with metal sub-rose

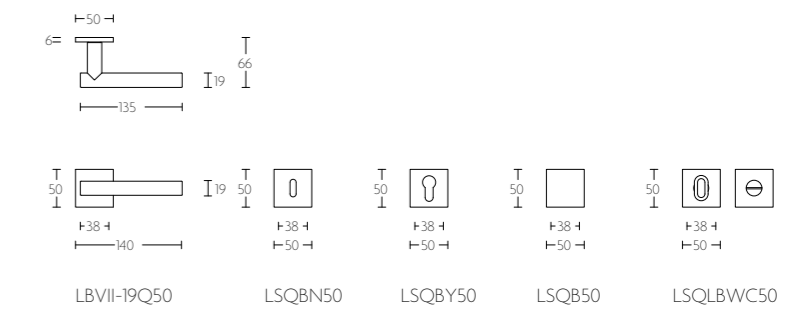

LBVI-19



mat roestvast staal  
satin stainless steel

deurkruk vast-draaibaar  
met metalen onderconstructie  
geveerd op rozet  
tevens EN1906 klasse 3 versie verkrijgbaar

sprung lever handle  
attached to rose  
with metal sub-rose  
also EN1906 class 3 version available

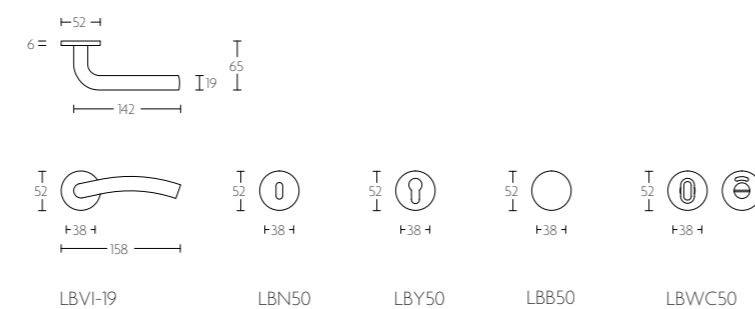

LBVII-19P236



mat roestvast staal  
satin stainless steel



mat zwart  
satin black

deurkruk vast-draaibaar  
ongeveerd op schild, een zijde met  
en een zijde zonder zichtbare bevestiging

unsprung lever handle  
attached to plate  
fixings visible on one side only

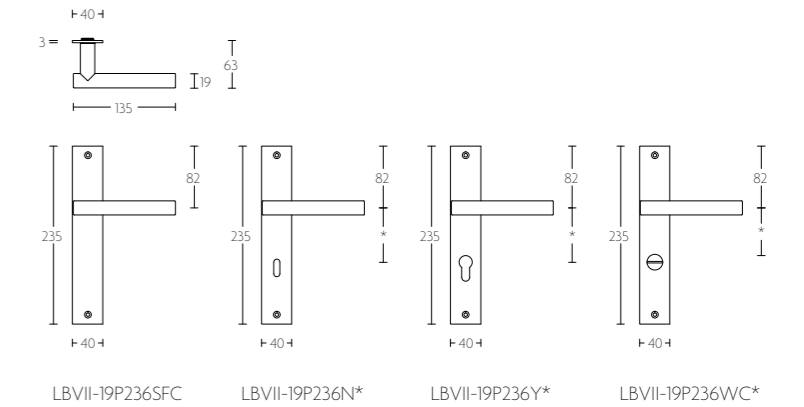

\* afstand opgeven bij bestelling  
\* state distance on order

# BASICS

DEURBESLAG | DOOR FITTINGS

LBVIII



mat roestvast staal  
satin stainless steel

massieve deurkruk vast-draaibaar met metalen onderconstructie geveerd op rozet

solid sprung lever handle attached to rose with metal sub-rose

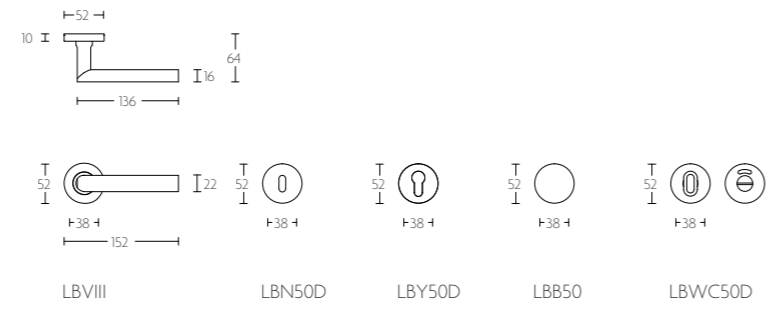

LBVIII LBN50D LBY50D LBB50 LBWC50D

# BASICS

DEURBESLAG | DOOR FITTINGS

LBXV



mat roestvast staal  
satin stainless steel

massieve deurkruk vast-draaibaar met metalen onderconstructie geveerd op rozet

solid sprung lever handle attached to rose with metal sub-rose

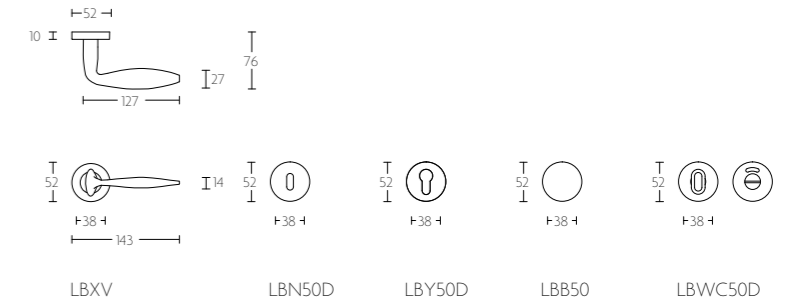

LBXV LBN50D LBY50D LBB50 LBWC50D

LBX



mat roestvast staal  
satin stainless steel

PVD mat roestvast staal  
PVD satin stainless steel

massieve deurkruk vast-draaibaar met metalen onderconstructie geveerd op rozet

solid sprung lever handle attached to rose with metal sub-rose

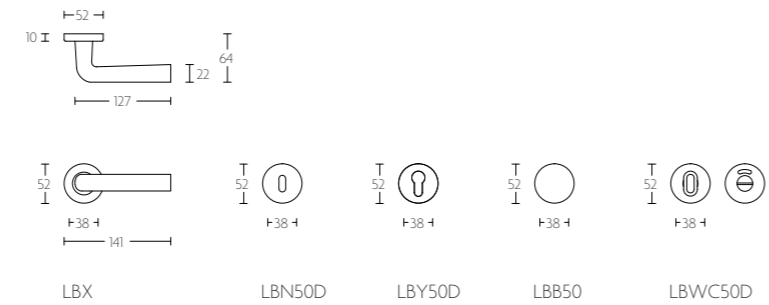

LBX LBN50D LBY50D LBB50 LBWC50D

LBXVII



gepolijst/mat roestvast staal  
polished/satin stainless steel

massieve deurkruk vast-draaibaar met metalen onderconstructie geveerd op rozet

solid sprung lever handle attached to rose with metal sub-rose



LBXVII LBN50D LBY50D LBB50 LBWC50D

LBXIV



mat roestvast staal  
satin stainless steel

PVD mat roestvast staal  
PVD satin stainless steel



mat zwart  
satin black



PVD mat goud  
PVD satin gold



PVD gepolijst koper  
PVD polished copper

massieve deurkruk vast-draaibaar met metalen onderconstructie geveerd op rozet

solid sprung lever handle attached to rose with metal sub-rose

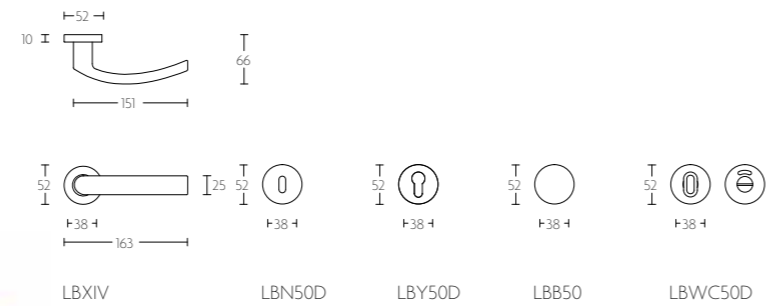

LBXIV LBN50D LBY50D LBB50 LBWC50D

LBXVIII



mat roestvast staal  
satin stainless steel

PVD mat roestvast staal  
PVD satin stainless steel



mat zwart  
satin black



PVD mat goud  
PVD satin gold



PVD gepolijst koper  
PVD polished copper

massieve deurkruk vast-draaibaar met metalen onderconstructie geveerd op rozet

solid sprung lever handle attached to rose with metal sub-rose

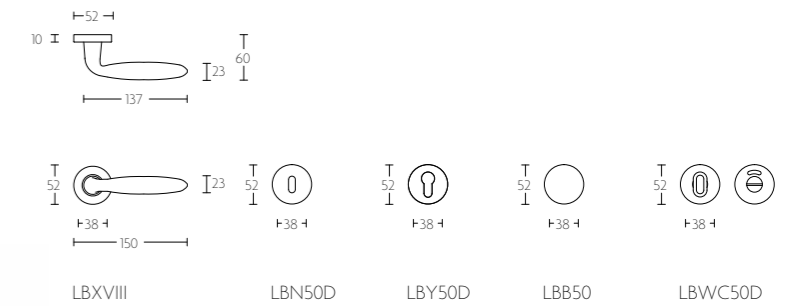

LBXVIII LBN50D LBY50D LBB50 LBWC50D



# BASICS

DEURBESLAG | DOOR FITTINGS

**LBXX**

massieve deurkruk vast-draaibaar met metalen onderconstructie geveerd op rozet | solid sprung lever handle attached to rose with metal sub-rose

mat roestvast staal  
satin stainless steel

mat zwart  
satin black

PVD mat goud  
PVD satin gold

PVD gepolijst koper  
PVD polished copper

LBXX LBN50D LBY50D LBB50 LBWC50

**LBXXI**

massieve deurkruk vast-draaibaar met metalen onderconstructie geveerd op rozet | solid sprung lever handle attached to rose with metal sub-rose

mat roestvast staal  
satin stainless steel

mat zwart  
satin black

PVD mat goud  
PVD satin gold

PVD gepolijst koper  
PVD polished copper

LBXXI LBN50D LBY50D LBB50 LBWC50

**LB52PD**

massieve knopkruk, ongeveer 6mm op rozet met metalen onderconstructie ideale doormaat slot 60mm | solid unsprung knob to operate on rose with metal sub-rose ideal lock backset 60mm

mat roestvast staal  
satin stainless steel

PVD mat roestvast staal  
PVD satin stainless steel

gepolijst roestvast staal  
polished stainless steel

LB52PD LBN50 LBY50 LBB50 LBWC50

# BASICS

DEURBESLAG | DOOR FITTINGS

**LBN50**

sleutelplaatje | key escutcheon

mat roestvast staal  
satin stainless steel

PVD mat roestvast staal  
PVD satin stainless steel

PVD gunmetal  
PVD gunmetal

gepolijst roestvast staal  
polished stainless steel

PVD mat goud  
PVD satin gold

mat zwart  
satin black

PVD gepolijst koper  
PVD polished copper

LBN50

**LBN50D**

sleutelplaatje | key escutcheon

mat roestvast staal  
satin stainless steel

PVD mat roestvast staal  
PVD satin stainless steel

mat zwart  
satin black

gepolijst roestvast staal  
polished stainless steel

PVD mat goud  
PVD satin gold

PVD gepolijst koper  
PVD polished copper

LBN50D

**LBY50**

cilinderplaatje | profile cylinder escutcheon

mat roestvast staal  
satin stainless steel

PVD mat roestvast staal  
PVD satin stainless steel

PVD gunmetal  
PVD gunmetal

gepolijst roestvast staal  
polished stainless steel

PVD mat goud  
PVD satin gold

mat zwart  
satin black

PVD gepolijst koper  
PVD polished copper

LBY50

**LBY50D**

cilinderplaatje | profile cylinder escutcheon

mat roestvast staal  
satin stainless steel

PVD mat roestvast staal  
PVD satin stainless steel

mat zwart  
satin black

gepolijst roestvast staal  
polished stainless steel

PVD mat goud  
PVD satin gold

PVD gepolijst koper  
PVD polished copper

LBY50D

**LBB50**

blind plaatje | blank escutcheon

mat roestvast staal  
satin stainless steel

PVD mat roestvast staal  
PVD satin stainless steel

PVD gunmetal  
PVD gunmetal

gepolijst roestvast staal  
polished stainless steel

PVD mat goud  
PVD satin gold

mat zwart  
satin black

PVD gepolijst koper  
PVD polished copper

LBB50

**LBWC50**

toiletgarnituur | turn and release set

mat roestvast staal  
satin stainless steel

PVD mat roestvast staal  
PVD satin stainless steel

PVD gunmetal  
PVD gunmetal

gepolijst roestvast staal  
polished stainless steel

PVD mat goud  
PVD satin gold

mat zwart  
satin black

PVD gepolijst koper  
PVD polished copper

LBWC50

# BASICS

DEURBESLAG | DOOR FITTINGS

### LBWC50D

toiletgarnituur | turn and release set



LBWC50D



### LBR32G

smalrozet dubbel geveerd  
t.b.v. aluminium of stalen  
deuren, combineren met  
deurkruk naar keuze

narrow rose with double  
spring to be combined  
with door handle of choice

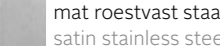
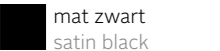

LBR32G    LBN32    LBY32

 mat roestvast staal satin stainless steel	 PVD mat roestvast staal PVD satin stainless steel	 gepolijst roestvast staal polished stainless steel
 mat zwart satin black	 PVD mat goud PVD satin gold	 PVD gepolijst koper PVD polished copper

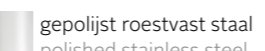
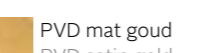
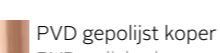
 mat roestvast staal satin stainless steel	 PVD mat roestvast staal PVD satin stainless steel	 gepolijst roestvast staal polished stainless steel	 mat zwart satin black
 PVD gunmetal PVD gunmetal	 PVD mat goud PVD satin gold	 PVD gepolijst koper PVD polished copper	

# BASICS

RAAMBESLAG | WINDOW FITTINGS

### LB-RB

massief raamboompje ten behoeve  
van naar buitendraaiend raam  
inclusief contraplaatje

solid casement fastener for  
outward opening window  
including mortise plate

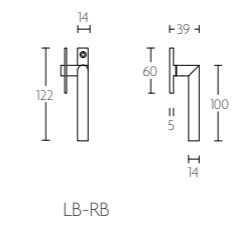



LB-RB

### HP-RB

losse haak ten behoeve van  
raamboompje voor naar  
binnendraaiend raam

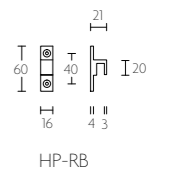
separate hook plate for  
casement fastener for inward  
opening window

HP-RB

 mat roestvast staal satin stainless steel	 gepolijst roestvast staal polished stainless steel
 mat roestvast staal satin stainless steel	 gepolijst roestvast staal polished stainless steel

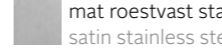
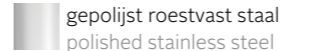
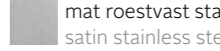
### LB305

massieve raamuitzetter  
met twee stelpennen  
inclusief geleiderail

solid casement stay  
with two pins  
including slide guide channel

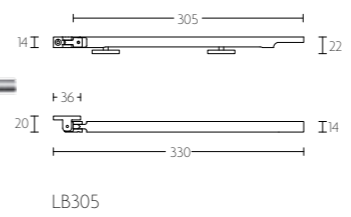
LB305

 mat roestvast staal satin stainless steel	 gepolijst roestvast staal polished stainless steel
--	---

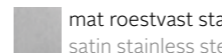
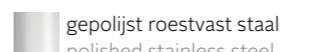
### LBI-DK-O

draaikiepgarnituur  
niet afsluitbaar

non-locking tilt and turn  
window handle



LBI-DK-O

 mat roestvast staal satin stainless steel	 gepolijst roestvast staal polished stainless steel
--	---

### LBIF-DK-O

verkropt draaikiepgarnituur  
niet afsluitbaar

non-locking offset tilt and  
turn window handle





LBIF-DK-O

 mat roestvast staal satin stainless steel
--



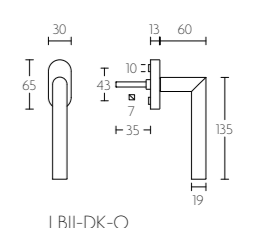

### LBII-DK-O

draaikiepgarnituur  
niet afsluitbaar

non-locking tilt and turn  
window handle

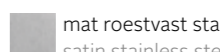
LBII-DK-O

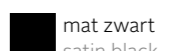
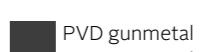
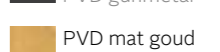
 mat roestvast staal satin stainless steel	 gepolijst roestvast staal polished stainless steel
 mat zwart satin black	 PVD gunmetal PVD gunmetal
 PVD mat goud PVD satin gold	 PVD gepolijst koper PVD polished copper



# BASICS

RAAMBESLAG | WINDOW FITTINGS

**LBIIT-DK-O** draaikepgarnituur niet afsluitbaar | non-locking tilt and turn window handle



mat roestvast staal  
satin stainless steel

**LBIII-DK-O** draaikepgarnituur niet afsluitbaar | non-locking tilt and turn window handle

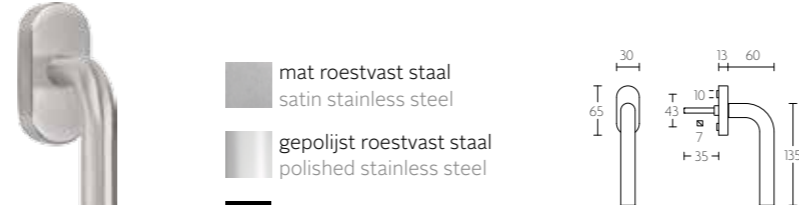

- mat roestvast staal  
satin stainless steel
- gepolijst roestvast staal  
polished stainless steel
- mat zwart  
satin black
- PVD gunmetal  
PVD gunmetal
- PVD mat goud  
PVD satin gold
- PVD gepolijst koper  
PVD polished copper

**LBIV-DK-O** draaikepgarnituur niet afsluitbaar | non-locking tilt and turn window handle



mat roestvast staal  
satin stainless steel

**LBVI-DK-O** draaikepgarnituur niet afsluitbaar | non-locking tilt and turn window handle



mat roestvast staal  
satin stainless steel

**LBVII-DK-O** draaikepgarnituur niet afsluitbaar | non-locking tilt and turn window handle



- mat roestvast staal  
satin stainless steel
- mat zwart  
satin black
- PVD gunmetal  
PVD gunmetal
- PVD mat goud  
PVD satin gold
- PVD gepolijst koper  
PVD polished copper

**LBVIII-DK-O** draaikepgarnituur niet afsluitbaar | non-locking tilt and turn window handle



mat roestvast staal  
satin stainless steel

**LBX-DK-O** draaikepgarnituur niet afsluitbaar | non-locking tilt and turn window handle



mat roestvast staal  
satin stainless steel

**LBXIV-DK-O** draaikepgarnituur niet afsluitbaar | non-locking tilt and turn window handle



- mat roestvast staal  
satin stainless steel
- mat zwart  
satin black
- PVD mat goud  
PVD satin gold
- PVD gepolijst koper  
PVD polished copper

**LBXV-DK-O** draaikepgarnituur niet afsluitbaar | non-locking tilt and turn window handle



mat roestvast staal  
satin stainless steel

**LBXVII-DK-O** draaikepgarnituur niet afsluitbaar | non-locking tilt and turn window handle



mat/gepolijst roestvast staal  
satin/polished stainless steel

**LBXVIII-DK-O** draaikepgarnituur niet afsluitbaar | non-locking tilt and turn window handle



- mat roestvast staal  
satin stainless steel
- mat zwart  
satin black
- PVD mat goud  
PVD satin gold
- PVD gepolijst koper  
PVD polished copper

**LBXX-DK-O** draaikepgarnituur niet afsluitbaar | non-locking tilt and turn window handle



- mat roestvast staal  
satin stainless steel
- mat zwart  
satin black
- PVD mat goud  
PVD satin gold
- PVD gepolijst koper  
PVD polished copper

# BASICS

RAAMBESLAG | WINDOW FITTINGS

**LBXXI-DK-O** draaikiëpgarnituur niet afsluitbaar | non-locking tilt and turn window handle



mat roestvast staal  
satin stainless steel

mat zwart  
satin black

PVD mat goud  
PVD satin gold

PVD gepolijst koper  
PVD polished copper

**LBI-DKLOCK-O** draaikiëpgarnituur afsluitbaar | locking tilt and turn window handle



mat roestvast staal  
satin stainless steel

gepolijst roestvast staal  
polished stainless steel

**LBIV-DKLOCK-O** draaikiëpgarnituur afsluitbaar | locking tilt and turn window handle



mat roestvast staal  
satin stainless steel

**LBVI-DKLOCK-O** draaikiëpgarnituur afsluitbaar | locking tilt and turn window handle





mat roestvast staal  
satin stainless steel

**LBIF-DKLOCK-O** verkropt draaikiëpgarnituur afsluitbaar | locking offset tilt and turn window handle

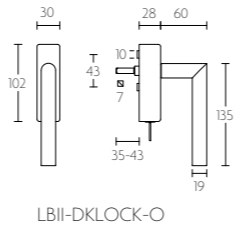

mat roestvast staal  
satin stainless steel

**LBII-DKLOCK-O** draaikiëpgarnituur afsluitbaar | locking tilt and turn window handle

mat roestvast staal  
satin stainless steel

gepolijst roestvast staal  
polished stainless steel

mat zwart  
satin black

PVD gunmetal  
PVD gunmetal

PVD mat goud  
PVD satin gold

PVD gepolijst koper  
PVD polished copper

**LBVII-DKLOCK-O** draaikiëpgarnituur afsluitbaar | locking tilt and turn window handle

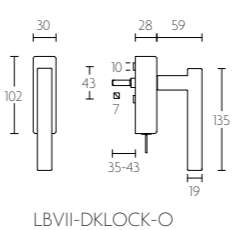
mat roestvast staal  
satin stainless steel

mat zwart  
satin black

PVD gunmetal  
PVD gunmetal

PVD mat goud  
PVD satin gold

PVD gepolijst koper  
PVD polished copper

**LBVIII-DKLOCK-O** draaikiëpgarnituur afsluitbaar | locking tilt and turn window handle





mat roestvast staal  
satin stainless steel

**LBIIIT-DKLOCK-O** draaikiëpgarnituur afsluitbaar | locking tilt and turn window handle

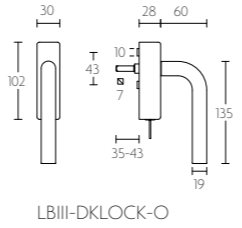

mat roestvast staal  
satin stainless steel

**LBIIII-DKLOCK-O** draaikiëpgarnituur afsluitbaar | locking tilt and turn window handle

mat roestvast staal  
satin stainless steel

gepolijst roestvast staal  
polished stainless steel

mat zwart  
satin black

PVD gunmetal  
PVD gunmetal

PVD mat goud  
PVD satin gold

PVD gepolijst koper  
PVD polished copper

**LBX-DKLOCK-O** draaikiëpgarnituur afsluitbaar | locking tilt and turn window handle



mat roestvast staal  
satin stainless steel

**LBXIV-DKLOCK-O** draaikiëpgarnituur afsluitbaar | locking tilt and turn window handle



mat roestvast staal  
satin stainless steel

mat zwart  
satin black

PVD mat goud  
PVD satin gold

PVD gepolijst koper  
PVD polished copper

# BASICS

RAAMBESLAG | WINDOW FITTINGS



# BASICS

RAAMBESLAG | WINDOW FITTINGS

**LBXV-DKLOCK-O** draaikiepgarnituur afsluitbaar | locking tilt and turn window handle



mat roestvast staal  
satin stainless steel

**LBXVII-DKLOCK-O** draaikiepgarnituur afsluitbaar | locking tilt and turn window handle



mat/gepolijst roestvast staal  
satin/polished stainless steel

**LBXVIII-DKLOCK-O** draaikiepgarnituur afsluitbaar | locking tilt and turn window handle



mat roestvast staal  
satin stainless steel

mat zwart  
satin black

PVD mat goud  
PVD satin gold

PVD gepolijst koper  
PVD polished copper

**LBXX-DKLOCK-O** draaikiepgarnituur afsluitbaar | locking tilt and turn window handle



mat roestvast staal  
satin stainless steel

mat zwart  
satin black

PVD mat goud  
PVD satin gold

PVD gepolijst koper  
PVD polished copper

**LBXXI-DKLOCK-O** draaikiepgarnituur afsluitbaar | locking tilt and turn window handle



mat roestvast staal  
satin stainless steel

mat zwart  
satin black

PVD mat goud  
PVD satin gold

PVD gepolijst koper  
PVD polished copper

**KO-LBI** krukespagolet inclusief vier geleiders, twee eindstukjes en twee stangen standaard geschikt tot 2900mm | espagnolette bolt with top and bottom receiver plate, two rods and four rod guides standard to suit 2900mm

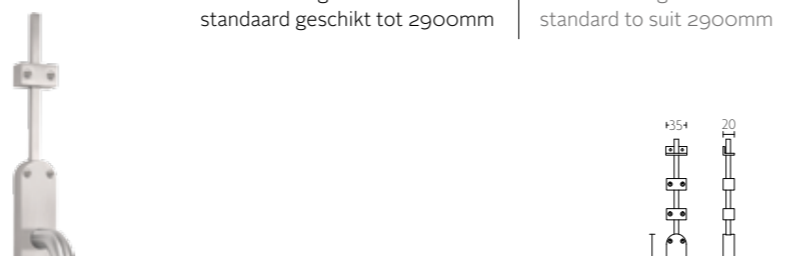

mat roestvast staal  
satin stainless steel

gepolijst roestvast staal  
polished stainless steel

**KO-LBII** krukespagolet inclusief vier geleiders, twee eindstukjes en twee stangen standaard geschikt tot 2900mm zwarte stangen optioneel | espagnolette bolt with top and bottom receiver plate, two rods and four rod guides standard to suit 2900mm black bars optional



mat roestvast staal  
satin stainless steel

gepolijst roestvast staal  
polished stainless steel

mat zwart  
satin black

PVD mat goud  
PVD satin gold

**KO-LBIIT** krukespagolet inclusief vier geleiders, twee eindstukjes en twee stangen standaard geschikt tot 2900mm | espagnolette bolt with top and bottom receiver plate, two rods and four rod guides standard to suit 2900mm

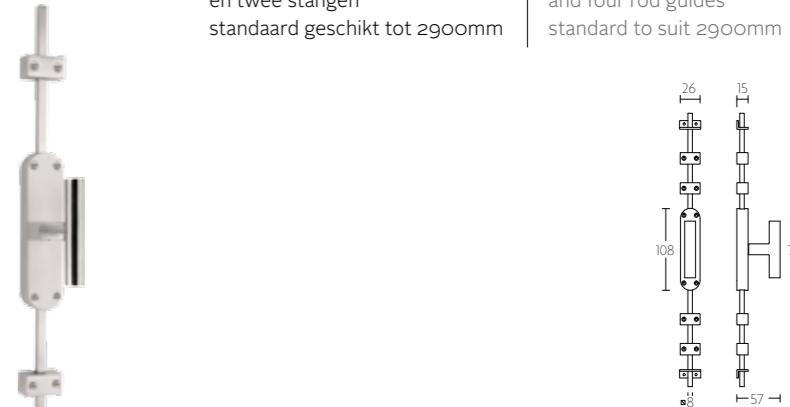

mat roestvast staal  
satin stainless steel

**KO-LBIII** krukespagolet inclusief vier geleiders, twee eindstukjes en twee stangen standaard geschikt tot 2900mm zwarte stangen optioneel | espagnolette bolt with top and bottom receiver plate, two rods and four rod guides standard to suit 2900mm black bars optional



mat roestvast staal  
satin stainless steel

gepolijst roestvast staal  
polished stainless steel

mat zwart  
satin black

PVD mat goud  
PVD satin gold

**KO-LBIV** krukespagolet inclusief vier geleiders, twee eindstukjes en twee stangen standaard geschikt tot 2900mm | espagnolette bolt with top and bottom receiver plate, two rods and four rod guides standard to suit 2900mm

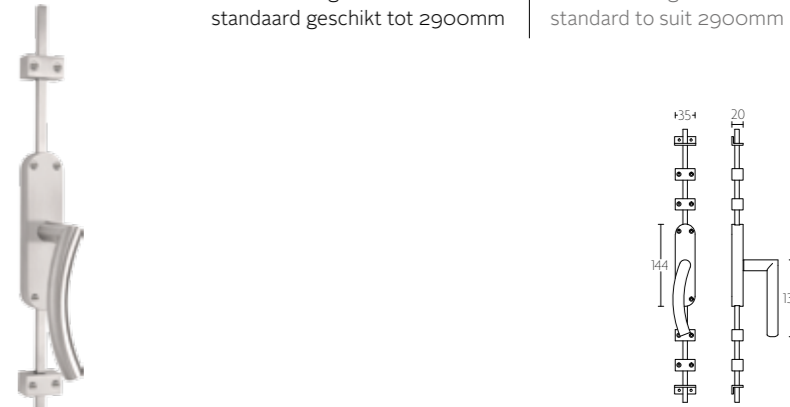

mat roestvast staal  
satin stainless steel

**KO-LBVI** krukespagolet inclusief vier geleiders, twee eindstukjes en twee stangen standaard geschikt tot 2900mm | espagnolette bolt with top and bottom receiver plate, two rods and four rod guides standard to suit 2900mm

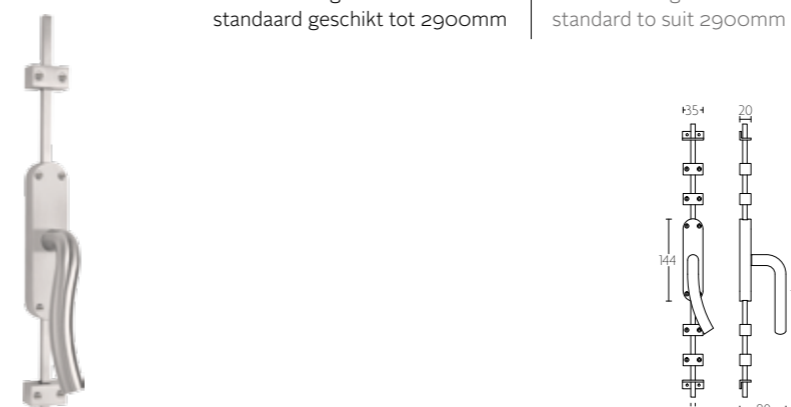

mat roestvast staal  
satin stainless steel

**KO-LBVII** krukespagolet inclusief vier geleiders, twee eindstukjes en twee stangen standaard geschikt tot 2900mm zwarte stangen optioneel | espagnolette bolt with top and bottom receiver plate, two rods and four rod guides standard to suit 2900mm black bars optional



mat roestvast staal  
satin stainless steel

gepolijst roestvast staal  
polished stainless steel

mat zwart  
satin black

PVD mat goud  
PVD satin gold

# BASICS

RAAMBESLAG | WINDOW FITTINGS

KO-LBVIII

krukespagolet inclusief vier geleiders, twee eindstukjes en twee stangen  
standaard geschikt tot 2900mm

espagnolette bolt with top and bottom receiver plate, two rods and four rod guides  
standard to suit 2900mm

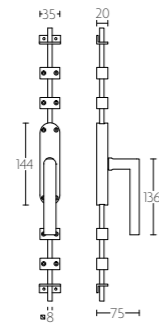

KO-LBVIII

mat roestvast staal  
satin stainless steel

KO-LBX

krukespagolet inclusief vier geleiders, twee eindstukjes en twee stangen  
standaard geschikt tot 2900mm

espagnolette bolt with top and bottom receiver plate, two rods and four rod guides  
standard to suit 2900mm

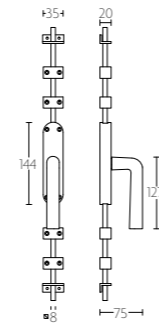

KO-LBX

mat roestvast staal  
satin stainless steel

KO-LBXX

krukespagolet inclusief vier geleiders, twee eindstukjes en twee stangen  
standaard geschikt tot 2900mm  
zwarte stangen optioneel

espagnolette bolt with top and bottom receiver plate, two rods and four rod guides  
standard to suit 2900mm  
black bars optional

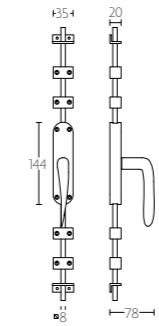

KO-LBXX

mat roestvast staal  
satin stainless steel  
mat zwart  
satin black  
PVD mat goud  
PVD satin gold

E-LOCK8

slot ten behoeve van espagnoletstang 8mm

lock for espagnolette rod 8mm

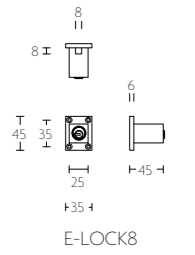

E-LOCK8

mat roestvast staal  
satin stainless steel  
gepolijst roestvast staal  
polished stainless steel  
mat zwart  
satin black

KO-LBXIV

krukespagolet inclusief vier geleiders, twee eindstukjes en twee stangen  
standaard geschikt tot 2900mm  
zwarte stangen optioneel

espagnolette bolt with top and bottom receiver plate, two rods and four rod guides  
standard to suit 2900mm  
black bars optional

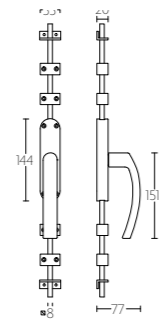

KO-LBXIV

mat roestvast staal  
satin stainless steel  
mat zwart  
satin black  
PVD mat goud  
PVD satin gold

KO-LBXV

krukespagolet inclusief vier geleiders, twee eindstukjes en twee stangen  
standaard geschikt tot 2900mm

espagnolette bolt with top and bottom receiver plate, two rods and four rod guides  
standard to suit 2900mm

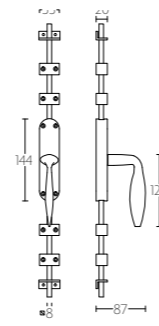

KO-LBXV

mat roestvast staal  
satin stainless steel

KO-LBXVII

krukespagolet inclusief vier geleiders, twee eindstukjes en twee stangen  
standaard geschikt tot 2900mm

espagnolette bolt with top and bottom receiver plate, two rods and four rod guides  
standard to suit 2900mm

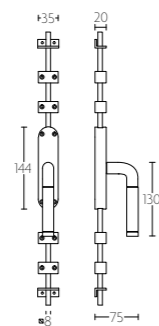

KO-LBXVII

mat/gepolijst roestvast staal  
satin/polished stainless steel

KO-LBXVIII

krukespagolet inclusief vier geleiders, twee eindstukjes en twee stangen  
standaard geschikt tot 2900mm  
zwarte stangen optioneel

espagnolette bolt with top and bottom receiver plate, two rods and four rod guides  
standard to suit 2900mm  
black bars optional

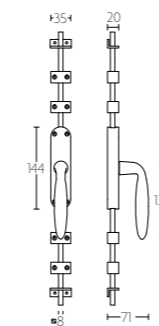

KO-LBXVIII

mat roestvast staal  
satin stainless steel  
mat zwart  
satin black  
PVD mat goud  
PVD satin gold



# BASICS

VOORDEURBESLAG | FRONT DOOR FITTINGS

**LB52V** massieve vaste voordeurknop | solid fixed front door knob



mat rvs  
satin. st. steel

PVD mat rvs  
PVD satin st. steel

gepolijst rvs  
polished st. steel

mat zwart  
satin black

LB52V

**LB52D** massieve draaibare voordeurknop op rozet, ongeveerd | solid unsprung front door knob to operate on rose



mat roestvast staal  
satin stainless steel

PVD mat roestvast staal  
PVD satin stainless steel

gepolijst roestvast staal  
polished stainless steel

LB52D

**LB55V** massieve voordeurknop vast op rozet | solid front door knob fixed on rose





mat roestvast staal  
satin stainless steel

PVD mat roestvast staal  
PVD satin stainless steel

gepolijst roestvast staal  
polished stainless steel

LB55V

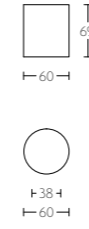
**LB60V** massieve vaste voordeurknop | solid fixed front door knob

mat rvs  
satin. st. steel

PVD mat rvs  
PVD satin st. steel

gepolijst rvs  
polished st. steel

mat zwart  
satin black

LB60V

**LB70V/A** massieve vaste voordeurknop | solid fixed front door knob

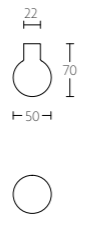
mat roestvast staal  
satin stainless steel

LB70V/A

**LB80V** voordeurknop vast op rozet | front door knob fixed on rose

mat roestvast staal  
satin stainless steel

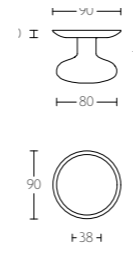
PVD mat roestvast staal  
PVD satin stainless steel

gepolijst roestvast staal  
polished stainless steel

mat zwart  
satin black

PVD gunmetal  
PVD gunmetal

PVD mat goud  
PVD satin gold

PVD gepolijst koper  
PVD polished copper

LB80V

**LB503V** voordeurknop vast op rozet | front door knob fixed on rose



mat roestvast staal  
satin stainless steel

mat zwart  
satin black

PVD gunmetal  
PVD gunmetal

PVD mat goud  
PVD satin gold

PVD gepolijst koper  
PVD polished copper

LB503V

**LB501** voordeurknop op rozet zowel vast als draaibaar leverbaar | front door knob available fixed or to operate



mat rvs  
satin. st. steel

mat zwart  
satin black



PVD gunmetal  
PVD gunmetal

PVD mat goud  
PVD satin gold

PVD gepolijst koper  
PVD polished copper

LB501



**LB502** voordeurknop op rozet zowel vast als draaibaar leverbaar | front door knob available fixed or to operate

mat roestvast staal  
satin stainless steel

LB502

**LB507V** massieve voordeurknop vast op rozet | solid front door knob fixed on rose

mat roestvast staal  
satin stainless steel

gepolijst roestvast staal  
polished stainless steel

LB507V

**LB701V** massieve voordeurknop vast op rozet | solid front door knob fixed on rose



mat roestvast staal  
satin stainless steel

PVD mat roestvast staal  
PVD satin stainless steel

gepolijst roestvast staal  
polished stainless steel

LB701V

**LB702V** massieve voordeurknop vast op rozet | solid front door knob fixed on rose



mat roestvast staal  
satin stainless steel

PVD mat roestvast staal  
PVD satin stainless steel

gepolijst roestvast staal  
polished stainless steel

LB702V

# BASICS

VOORDEURBESLAG | FRONT DOOR FITTINGS

**LBT**

greep tbv houten, glazen of aluminium deuren  
doorgaande, niet-doorgaande of paarsgewijze bevestiging

pull handle for timber, glass or aluminium doors  
bolt through, concealed or back to back fixings

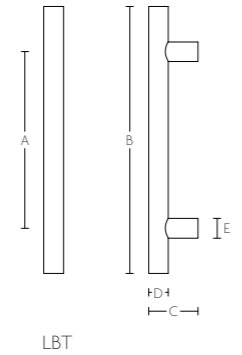
standaard maten | standard sizes

A	B	C	D Ø	E Ø
200	300	55	19	18
300	500	55	19	18
500	700	55	19	18
300	500	68	25	20
500	700	68	25	20
300	500	73	32	25
500	700	73	32	25
650	810	73	32	25
1000	1200	73	32	25

tevens maatwerk verkrijgbaar  
also custom made sizes available

- mat roestvast staal  
satin stainless steel
- gepolijst roestvast staal (beperkte maten)  
polished stainless steel (limited dimensions)
- mat zwart (beperkte maten)  
satin black (limited dimensions)

**LBT-S**

greep tbv houten, glazen of aluminium deuren  
doorgaande, niet-doorgaande of paarsgewijze bevestiging

pull handle for timber, glass or aluminium doors  
bolt through, concealed or back to back fixings

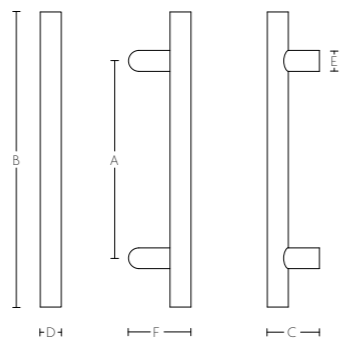
standaard maten | standard sizes

A	B	C	D Ø	E Ø	F
300	500	90	25	20	70
500	700	90	25	20	70
300	500	97	32	25	77
500	700	97	32	25	77
650	810	97	32	25	77

tevens maatwerk verkrijgbaar  
also custom made sizes available

mat roestvast staal  
satin stainless steel

**LBT-T**

greep tbv houten, glazen of aluminium deuren  
doorgaande, niet-doorgaande of paarsgewijze bevestiging

pull handle for timber, glass or aluminium doors  
bolt through, concealed or back to back fixings

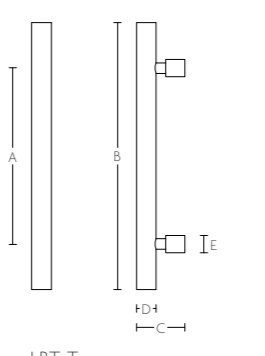
standaard maten | standard sizes

A	B	C	D Ø	E Ø
200	300	55	19	20
300	500	55	19	20
500	700	55	19	20
300	500	68	25	25
500	700	68	25	25
300	500	73	32	30
500	700	73	32	30
650	810	73	32	30
1000	1200	73	32	30

tevens maatwerk verkrijgbaar  
also custom made sizes available

mat roestvast staal  
satin stainless steel

# BASICS

VOORDEURBESLAG | FRONT DOOR FITTINGS

**LBU**

greep tbv houten, glazen of aluminium deuren  
doorgaande, niet-doorgaande of paarsgewijze bevestiging

pull handle for timber, glass or aluminium doors  
bolt through, concealed or back to back fixings

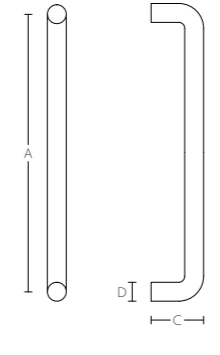
standaard maten | standard sizes

A	C	D Ø
200	65	19
300	65	19
300	75	25
400	68	25
300	80	32
400	80	32
600	80	32

tevens maatwerk verkrijgbaar  
also custom made sizes available

mat roestvast staal  
satin stainless steel

**LBU-90**

greep tbv houten, glazen of aluminium deuren  
doorgaande, niet-doorgaande of paarsgewijze bevestiging

pull handle for timber, glass or aluminium doors  
bolt through, concealed or back to back fixings

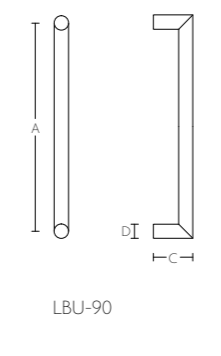
standaard maten | standard sizes

A	C	D Ø
300	65	19
300	75	25
300	80	32

tevens maatwerk verkrijgbaar  
also custom made sizes available

mat roestvast staal  
satin stainless steel

**BVEIL** massieve veiligheidscilinderrozet | solid security escutcheons

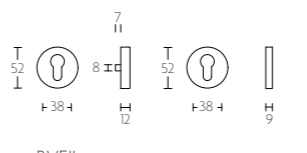
mat roestvast staal  
satin stainless steel

PVD mat roestvast staal  
PVD satin stainless steel

PVD gunmetal  
PVD gunmetal

gepolijst roestvast staal  
polished stainless steel

PVD mat goud  
PVD satin gold

PVD gepolijst koper  
PVD polished copper

mat zwart  
satin black

**BVEIL-KT** massieve veiligheidscilinderrozet met kerntrekbeveiliging | solid security escutcheons with cylinder protection cover



mat roestvast staal  
satin stainless steel

PVD mat roestvast staal  
PVD satin stainless steel

PVD gunmetal  
PVD gunmetal

gepolijst roestvast staal  
polished stainless steel

PVD mat goud  
PVD satin gold

PVD gepolijst koper  
PVD polished copper

mat zwart  
satin black



# BASICS

VOORDEURBESLAG | FRONT DOOR FITTINGS

**LBVEIL** massieve veiligheidscilinderrozet | solid security escutcheons

mat roestvast staal satin stainless steel  
mat zwart satin black

PVD mat roestvast staal PVD satin stainless steel  
PVD mat goud PVD satin gold

gepolijst roestvast staal polished stainless steel

**SKG**

**LBVEIL-KT** massieve veiligheidscilinderrozet | solid security escutcheons

mat roestvast staal satin stainless steel  
mat zwart satin black

PVD mat roestvast staal PVD satin stainless steel  
PVD mat goud PVD satin gold

gepolijst roestvast staal polished stainless steel

**SKG**

**LB507-50** massieve veiligheidsschilden met vaste knop, ten behoeve van deurkruk | solid security plates with fixed knob to suit lever handle

mat roestvast staal satin stainless steel  
gepolijst roestvast staal polished stainless steel

**SKG**

**LB507-50KT** massieve veiligheidsschilden met vaste knop, ten behoeve van deurkruk met kerntrekbeveiliging | solid security plates with fixed knob to suit lever handle with cylinder protection cover

mat roestvast staal satin stainless steel  
gepolijst roestvast staal polished stainless steel

**SKG**

**LB60-50** massieve veiligheidsschilden met vaste knop, ten behoeve van deurkruk | solid security plates with fixed knob to suit lever handle

mat roestvast staal satin stainless steel  
PVD mat roestvast staal PVD satin stainless steel  
gepolijst roestvast staal polished stainless steel

**SKG**

**LB60-50KT** massieve veiligheidsschilden met vaste knop, ten behoeve van deurkruk met kerntrekbeveiliging | solid security plates with fixed knob to suit lever handle with cylinder protection cover

mat roestvast staal satin stainless steel  
PVD mat roestvast staal PVD satin stainless steel  
gepolijst roestvast staal polished stainless steel

**SKG**

# BASICS

VOORDEURBESLAG | FRONT DOOR FITTINGS

**LBSM-50** massieve veiligheidsschilden ten behoeve van deurkrukken | solid security plates to suit lever handles

mat roestvast staal satin stainless steel  
PVD mat roestvast staal PVD satin stainless steel  
gepolijst roestvast staal polished stainless steel

**SKG**

**LBSM-50KT** massieve veiligheidsschilden ten behoeve van deurkrukken met kerntrekbeveiliging | solid security plates to suit lever handles with cylinder protection cover

mat roestvast staal satin stainless steel  
PVD mat roestvast staal PVD satin stainless steel  
gepolijst roestvast staal polished stainless steel

**SKG**

**LB60-28** massieve veiligheidsschilden met vaste knop, ten behoeve van deurkruk | solid security plates with fixed knob to suit lever handle

mat roestvast staal satin stainless steel  
PVD mat roestvast staal PVD satin stainless steel  
gepolijst roestvast staal polished stainless steel

**SKG**

**LB60-28KT** massieve veiligheidsschilden met vaste knop, ten behoeve van deurkruk met kerntrekbeveiliging | solid security plates with fixed knob to suit lever handle with cylinder protection cover

mat roestvast staal satin stainless steel  
PVD mat roestvast staal PVD satin stainless steel  
gepolijst roestvast staal polished stainless steel

**SKG**

**LBSM-28** massieve veiligheidsschilden ten behoeve van deurkrukken | solid security plates to suit lever handles

mat roestvast staal satin stainless steel  
PVD mat roestvast staal PVD satin stainless steel  
gepolijst roestvast staal polished stainless steel

**SKG**

**LBSM-28KT** massieve veiligheidsschilden ten behoeve van deurkrukken met kerntrekbeveiliging | solid security plates to suit lever handles with cylinder protection cover

mat roestvast staal satin stainless steel  
PVD mat roestvast staal PVD satin stainless steel  
gepolijst roestvast staal polished stainless steel

**SKG**

# BASICS

VOORDEURBESLAG | FRONT DOOR FITTINGS

**LB535** massieve buitenbriefplaat | solid letter plate

- mat roestvast staal  
satin stainless steel
- PVD mat roestvast staal  
PVD satin stainless steel
- gepolijst roestvast staal  
polished stainless steel
- mat zwart  
satin black
- PVD gunmetal  
PVD gunmetal
- PVD mat goud  
PVD satin gold
- PVD gepolijst koper  
PVD polished copper

**LB535BI** massieve tochtborstel | solid internal tidy

- mat roestvast staal  
satin stainless steel
- PVD mat roestvast staal  
PVD satin stainless steel
- gepolijst roestvast staal  
polished stainless steel
- mat zwart  
satin black
- PVD gunmetal  
PVD gunmetal
- PVD mat goud  
PVD satin gold
- PVD gepolijst koper  
PVD polished copper

**LB520** buitenbriefplaat | letter plate

- mat roestvast staal  
satin stainless steel
- PVD mat roestvast staal  
PVD satin stainless steel

**LB50** beldrukker met roestvast stalen drukkertje | bell push with stainless steel bell button

- mat roestvast staal  
satin stainless steel
- PVD mat roestvast staal  
PVD satin stainless steel
- gepolijst roestvast staal  
polished stainless steel
- mat zwart  
satin black
- PVD gunmetal  
PVD gunmetal
- PVD mat goud  
PVD satin gold
- PVD gepolijst koper  
PVD polished copper

**LB51** beldrukker met roestvast stalen drukkertje | bell push with stainless steel bell button

- mat roestvast staal  
satin stainless steel
- PVD mat roestvast staal  
PVD satin stainless steel
- gepolijst roestvast staal  
polished stainless steel

**LBHN100-0** huisnummer 0 met blinde bevestiging en afstandhouders | numeral 0 with concealed stand off bush fixings

- mat roestvast staal  
satin stainless steel
- PVD mat roestvast staal  
PVD satin stainless steel
- gepolijst roestvast staal  
polished stainless steel

# BASICS

VOORDEURBESLAG | FRONT DOOR FITTINGS

**LBHN100-1** huisnummer 1 met blinde bevestiging en afstandhouders | numeral 1 with concealed stand off bush fixings

- mat roestvast staal  
satin stainless steel
- PVD mat roestvast staal  
PVD satin stainless steel
- gepolijst roestvast staal  
polished stainless steel

**LBHN100-2** huisnummer 2 met blinde bevestiging en afstandhouders | numeral 2 with concealed stand off bush fixings

- mat roestvast staal  
satin stainless steel
- PVD mat roestvast staal  
PVD satin stainless steel
- gepolijst roestvast staal  
polished stainless steel

**LBHN100-3** huisnummer 3 met blinde bevestiging en afstandhouders | numeral 3 with concealed stand off bush fixings

- mat roestvast staal  
satin stainless steel
- PVD mat roestvast staal  
PVD satin stainless steel
- gepolijst roestvast staal  
polished stainless steel

**LBHN100-4** huisnummer 4 met blinde bevestiging en afstandhouders | numeral 4 with concealed stand off bush fixings

- mat roestvast staal  
satin stainless steel
- PVD mat roestvast staal  
PVD satin stainless steel
- gepolijst roestvast staal  
polished stainless steel

**LBHN100-5** huisnummer 5 met blinde bevestiging en afstandhouders | numeral 5 with concealed stand off bush fixings

- mat roestvast staal  
satin stainless steel
- PVD mat roestvast staal  
PVD satin stainless steel
- gepolijst roestvast staal  
polished stainless steel

**LBHN100-6/9** huisnummer 6/9 met blinde bevestiging en afstandhouders | numeral 6/9 with concealed stand off bush fixings

- mat roestvast staal  
satin stainless steel
- PVD mat roestvast staal  
PVD satin stainless steel
- gepolijst roestvast staal  
polished stainless steel

# BASICS

VOORDEURBESLAG | FRONT DOOR FITTINGS

**LBHN100-7**

huisnummer 7 met blinde bevestiging en afstandhouders | numeral 7 with concealed stand off bush fixings

mat roestvast staal satin stainless steel | PVD mat roestvast staal PVD satin stainless steel | gepolijst roestvast staal polished stainless steel

**LBHN100-8**

huisnummer 8 met blinde bevestiging en afstandhouders | numeral 8 with concealed stand off bush fixings

mat roestvast staal satin stainless steel | PVD mat roestvast staal PVD satin stainless steel | gepolijst roestvast staal polished stainless steel

**LBHN100-9/6**

huisnummer 9/6 met blinde bevestiging en afstandhouders | numeral 9/6 with concealed stand off bush fixings

mat roestvast staal satin stainless steel | PVD mat roestvast staal PVD satin stainless steel | gepolijst roestvast staal polished stainless steel

**LBHN100-A**

letter a met blinde bevestiging en afstandhouders | letter a with concealed stand off bush fixings

mat roestvast staal satin stainless steel | PVD mat roestvast staal PVD satin stainless steel | gepolijst roestvast staal polished stainless steel

**LBHN100-B**

letter b met blinde bevestiging en afstandhouders | letter b with concealed stand off bush fixings

mat roestvast staal satin stainless steel | PVD mat roestvast staal PVD satin stainless steel | gepolijst roestvast staal polished stainless steel

**LBHN100-C**

letter c met blinde bevestiging en afstandhouders | letter c with concealed stand off bush fixings

mat roestvast staal satin stainless steel | PVD mat roestvast staal PVD satin stainless steel | gepolijst roestvast staal polished stainless steel

# BASICS

VOORDEURBESLAG | FRONT DOOR FITTINGS

**LBHN100-D**

letter d met blinde bevestiging en afstandhouders | letter d with concealed stand off bush fixings

mat roestvast staal satin stainless steel | PVD mat roestvast staal PVD satin stainless steel | gepolijst roestvast staal polished stainless steel

**LBHN100-E**

letter e met blinde bevestiging en afstandhouders | letter e with concealed stand off bush fixings

mat roestvast staal satin stainless steel | PVD mat roestvast staal PVD satin stainless steel | gepolijst roestvast staal polished stainless steel

**LB39**

massieve deurklopper met doorgaande bevestiging | solid door knocker with bolt-through fixings

mat roestvast staal satin stainless steel | gepolijst roestvast staal polished stainless steel



# BASICS

MAILBOXES | MAILBOXES

**ANTARES** mailbox inclusief cilinderslot | mailbox including cylinder lock

mat roestvast staal AISI 316  
satin stainless steel AISI 316

**ARCTURUS** mailbox inclusief cilinderslot | mailbox including cylinder lock

mat roestvast staal AISI 316  
satin stainless steel AISI 316

**CAPELLA** mailbox inclusief cilinderslot | mailbox including cylinder lock

mat roestvast staal AISI 316  
satin stainless steel AISI 316

**VEGA** mailbox inclusief cilinderslot | mailbox including cylinder lock

mat roestvast staal AISI 316  
satin stainless steel AISI 316

**SIRIUS** mailbox inclusief cilinderslot | mailbox including cylinder lock

mat roestvast staal  
satin stainless steel

# BASICS

ACCESSOIRES | ACCESSORIES

**LB57S** set inbouwkommen te verlijmen inclusief 6mm stift (exclusief slot) | set of flush pulls for glue fitting including 6mm spindle (lock not included)

mat roestvast staal  
satin stainless steel

gepolijst roestvast staal  
polished stainless steel

mat zwart  
satin black

**LB57** inbouwkom te verlijmen | flush pull for glue fitting

mat roestvast staal  
satin stainless steel

gepolijst roestvast staal  
polished stainless steel

mat zwart  
satin black

**LB29** fingertip kopse kant deur ter verlijmen | fingertip edge fitting for glue fitting

mat roestvast staal  
satin stainless steel

gepolijst roestvast staal  
polished stainless steel

mat zwart  
satin black

**LB41** inbouwkom te verlijmen | flush pull for glue fitting

mat roestvast staal  
satin stainless steel

gepolijst roestvast staal  
polished stainless steel

mat zwart  
satin black

PVD mat goud  
PVD satin gold

PVD gepolijst koper  
PVD polished copper

**LB65** inbouwkom te verlijmen | flush pull for glue fitting

mat roestvast staal  
satin stainless steel

**LB170** inbouwkom | flush pull

mat roestvast staal  
satin stainless steel

# BASICS

ACCESSOIRES | ACCESSORIES

**LBP10** massieve meubelknop | solid cabinet knob



mat roestvast staal  
satin stainless steel

**LBP15** massieve meubelknop | solid cabinet knob



mat roestvast staal  
satin stainless steel

**LBP20** massieve meubelknop | solid cabinet knob



mat roestvast staal  
satin stainless steel

**LB47V** massieve (meterkast)knop | solid cabinet knob



mat roestvast staal  
satin stainless steel

gepolijst roestvast staal  
polished stainless steel

**LB501VP13** meterkastknop vast op schild | cabinet knob fixed on plate

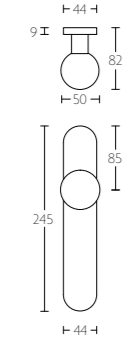
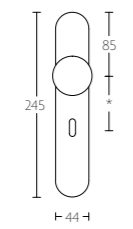
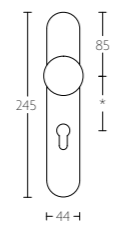
mat roestvast staal  
satin stainless steel

\* afstand opgeven bij bestelling  
\* state distance on order

**LB52G** set massieve glasdeurknoppen vast | set of solid knobs for glass door fixed



mat roestvast staal  
satin stainless steel

gepolijst roestvast staal  
polished stainless steel

# BASICS

ACCESSOIRES | ACCESSORIES

**LB60G** set massieve glasdeurknoppen vast | set of solid knobs for glass door fixed



mat roestvast staal  
satin stainless steel

gepolijst roestvast staal  
polished stainless steel

**LBPH20** massieve haak | solid hook

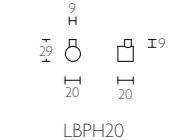
mat roestvast staal  
satin stainless steel

**LBPH30** massieve haak | solid hook

mat roestvast staal  
satin stainless steel

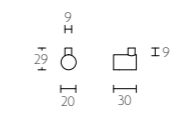
**LB64** massieve haak | solid hook

mat roestvast staal  
satin stainless steel

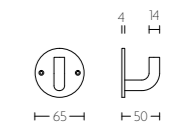
**LB230** massieve set hefschuifdeurbeslag inclusief schuifdeurkom voor buitenzijde | single solid internal lift-up sliding door handle with external flush pull

mat roestvast staal  
satin stainless steel

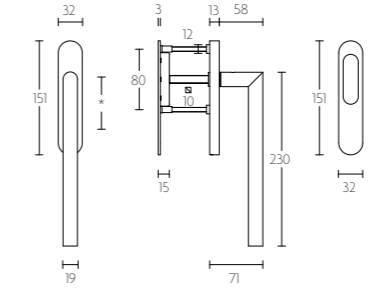
gepolijst roestvast staal  
polished stainless steel

mat zwart  
satin black

\* blind of PC69  
\* blind or Y69

**LB230PA** massieve paarsgewijze set hefschuifdeurbeslag | pair of solid lift-up sliding door handles

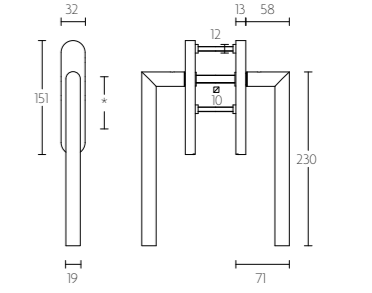
mat roestvast staal  
satin stainless steel

gepolijst roestvast staal  
polished stainless steel

mat zwart  
satin black

\* blind of PC69  
\* blind or Y69

# BASICS

ACCESSOIRES | ACCESSORIES

**LB231** massieve set hefschuifdeurbeslag inclusief schuifdeurkom voor buitenzijde | single solid internal lift-up sliding door handle with external flush pull

LB231 \* blind of PC6g \* blind or Y6g

mat roestvast staal satin stainless steel | gepolijst roestvast staal polished stainless steel | mat zwart satin black

**LB231PA** massieve paarsgewijze set hefschuifdeurbeslag | pair of solid lift-up sliding door handles

LB231PA \* blind of PC6g \* blind or Y6g

mat roestvast staal satin stainless steel | gepolijst roestvast staal polished stainless steel | mat zwart satin black

**LBPCG** deurstop, vloer | floor mounted door stop

LBPCG

mat roestvast staal satin stainless steel

**LBPG** deurstop, wand | wall mounted door stop

LBPG

mat roestvast staal satin stainless steel

**LB10** deurstop, vloer | floor mounted door stop

LB10

mat roestvast staal satin stainless steel | gepolijst roestvast staal polished stainless steel | mat zwart satin black

PVD gunmetal | PVD mat goud | PVD gepolijst koper | PVD gunmetal | PVD satin gold | PVD polished copper

**LB30** deurstop vloer- en wand | door stop floor and wall mounted

LB30

mat roestvast staal satin stainless steel | gepolijst roestvast staal polished stainless steel | mat zwart satin black

PVD gunmetal | PVD mat goud | PVD gepolijst koper | PVD gunmetal | PVD satin gold | PVD polished copper

**LB25** deurstop, vloer | floor mounted door stop

LB25

mat roestvast staal satin stainless steel

**LB22** deurstop, vloer | floor mounted door stop

LB22

mat roestvast staal satin stainless steel | gepolijst roestvast staal polished stainless steel

**LB85** deurstop, wand | wall mounted door stop

LB85

mat roestvast staal satin stainless steel

**LB306** garderobehaak | projecting coat rail

LB306

mat roestvast staal satin stainless steel

**LB432** massieve kledinghanger | solid coat hanger

LB432

mat roestvast staal satin stainless steel

**LBSA8989** kogellagerscharnier | hinge with ball bearings

LBSA8989

mat roestvast staal satin stainless steel | gepolijst roestvast staal polished stainless steel

PVD gunmetal | PVD mat goud | PVD gepolijst koper | PVD gunmetal | PVD satin gold | PVD polished copper

# BASICS

ACCESSOIRES | ACCESSORIES



# BASICS

ACCESSOIRES | ACCESSORIES

**LBSA7676** kogellagerscharnier | hinge with ball bearings

mat roestvast staal  
satin stainless steel

gepolijst roestvast staal  
polished stainless steel

PVD gunmetal  
PVD gunmetal

PVD mat goud  
PVD satin gold

PVD gepolijst koper  
PVD polished copper

LBSA7676

**LBS8989** kogellagerscharnier | hinge with ball bearings

mat roestvast staal  
satin stainless steel

gepolijst roestvast staal  
polished stainless steel

PVD gunmetal  
PVD gunmetal

PVD mat goud  
PVD satin gold

PVD gepolijst koper  
PVD polished copper

LBS8989

**LBS7676** kogellagerscharnier | hinge with ball bearings

mat roestvast staal  
satin stainless steel

gepolijst roestvast staal  
polished stainless steel

PVD gunmetal  
PVD gunmetal

PVD mat goud  
PVD satin gold

PVD gepolijst koper  
PVD polished copper

LBS7676

# BASICS SOLIDE

DEURBESLAG | DOOR FITTINGS

**LBS-D**

dikwandige deurkruk vast-draaibaar  
ongeveer op 3mm massief schild  
voorzien van hoogwaardige polymeer glijlager  
bevestiging (M5) eenzijdig zichtbaar

unsprung lever handle  
with thicker gauge tube wall  
attached to 3mm solid plate

mat roestvast staal  
satin stainless steel

LBS-DSFC

LBS-DN\*

LBS-DY\*

LBS-DWC\*

\* afstand opgeven bij bestelling  
\* state distance on order

**LBS-L**

dikwandige deurkruk vast-draaibaar  
ongeveer op 3mm massief schild  
voorzien van hoogwaardige polymeer glijlager  
bevestiging (M5) eenzijdig zichtbaar

unsprung lever handle  
with thicker gauge tube wall  
attached to 3mm solid plate

mat roestvast staal  
satin stainless steel

LBS-LSFC

LBS-LN\*

LBS-LY\*

LBS-LWC\*

\* afstand opgeven bij bestelling  
\* state distance on order

**LBS-K**

massieve knop vast op 3mm massief schild | solid knob fixed on 3mm solid plate

mat roestvast staal  
satin stainless steel

LBS-KSFC

LBS-KN\*

LBS-KY\*

\* afstand opgeven bij bestelling  
\* state distance on order





# THE NETHER LANDS MAAS TRICHT

LOCATION: MAASTRICHT, THE NETHERLANDS  
OBJECT: MAASTRICHT UMC+ HOSPITAL  
ARCHITECTURE: ARCHITECTEN AAN DE MAAS  
PHOTOGRAPHY: TYCHO MERIJN ROEST





**BASICS**  
LBS-D LEVER HANDLE SATIN STAINLESS STEEL







## 715 BEDS AND 5.000 STUDENTS

Het Maastricht Universitair Medisch Centrum+ is de overkoepelende naam voor de samenwerking tussen het Academisch ziekenhuis Maastricht (azM) en de Universiteit Maastricht (UM). In dit academische ziekenhuis met 715 bedden werken circa 7.000 mensen en 5.000 studenten.

De kerntaken van Maastricht UMC+ zijn patiëntenzorg, onderwijs en onderzoek. Het ziekenhuis maakt deel uit van de Brightlands Health Campus en onderscheidt zich (inter)nationaal door de focus op preventie. Er is dus aandacht voor meer dan alleen gezondheidsherstel.

Maastricht University Medical Centre+ (Maastricht UMC+) is the umbrella term for the partnership between Academic Hospital Maastricht AZM and Maastricht University. This academic hospital counts 715 beds and has 7,000 staff and 5,000 students working here.

The focus areas of Maastricht UMC+ are patient care, education, and research. The hospital is part of the Brightlands Health Campus and is internationally distinguished by its focus on prevention. This means that attention is paid to more than the recovery of health alone.

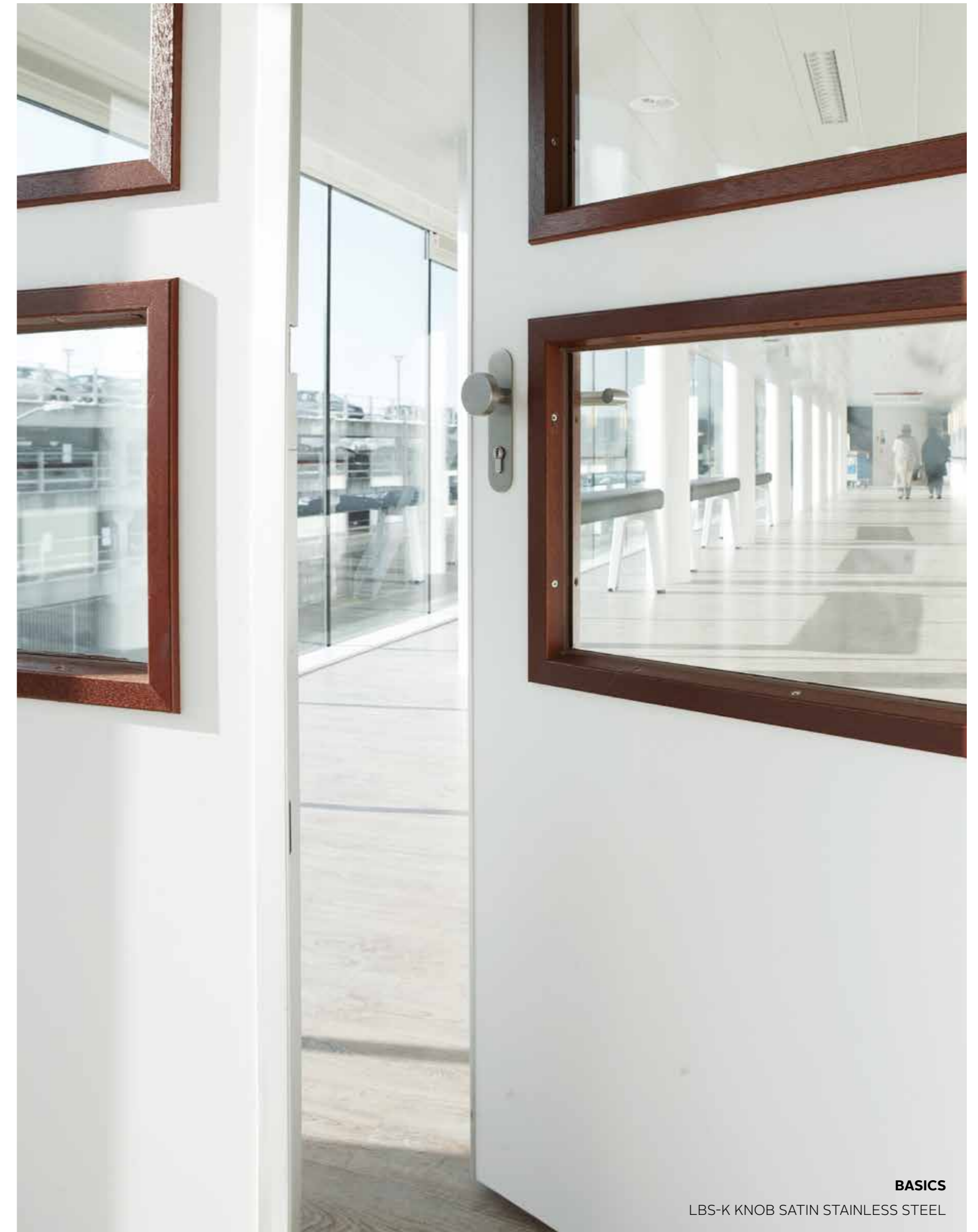

**BASICS**  
LBS-K KNOB SATIN STAINLESS STEEL





## WHEN IT GETS TOUGH

Het Maastricht UMC+ koos voor de doorware uit de Basics collectie van FORMANI®. De speciaal voor het ziekenhuis ontwikkelde Basics Solide serie is een antwoord op het intense en soms hardhandige gebruik waaraan beslag in een dergelijke omgeving dient te voldoen, denk alleen al aan bedden die in een ziekenhuis langs de deuren schuren.

De Basics Solide serie is gemaakt uit extra dikwandig buismateriaal en voorzien van een massieve, ofwel solide, nek op een 3mm dik schild. De bevestiging van de kruk op een schild met speciale glijlagers garandeert langdurig, geruisloos gebruik. Stevige M5 bouten zien toe op een degelijke bevestiging. De kwaliteiten van deze serie blijven niet onopgemerkt. Er zijn steeds meer gezondheidscentra en scholen die vanwege het duurzame karakter voor deze serie van FORMANI® kiezen.

Maastricht UMC+ chose the door fittings from the FORMANI® Basics collection. The Basics Solide series was developed specially for the hospital and serves as a solution for the hardy wear that fittings in such surrounding have to endure, such as hospital beds being pushed against doors as they're being moved through the hospital.

The Basic Solide series was made of extra thick-walled tubing and features a solid neck on a 3 mm-thick plate. The attachment of the handle on a plate with special sliding bearings guarantees long-term use without making a sound. Solid M5 screws ensure that it is always properly attached. The excellent features of this series have not gone unnoticed and an increasing number of health centres and schools are choosing this series by FORMANI® for its long-lasting quality.

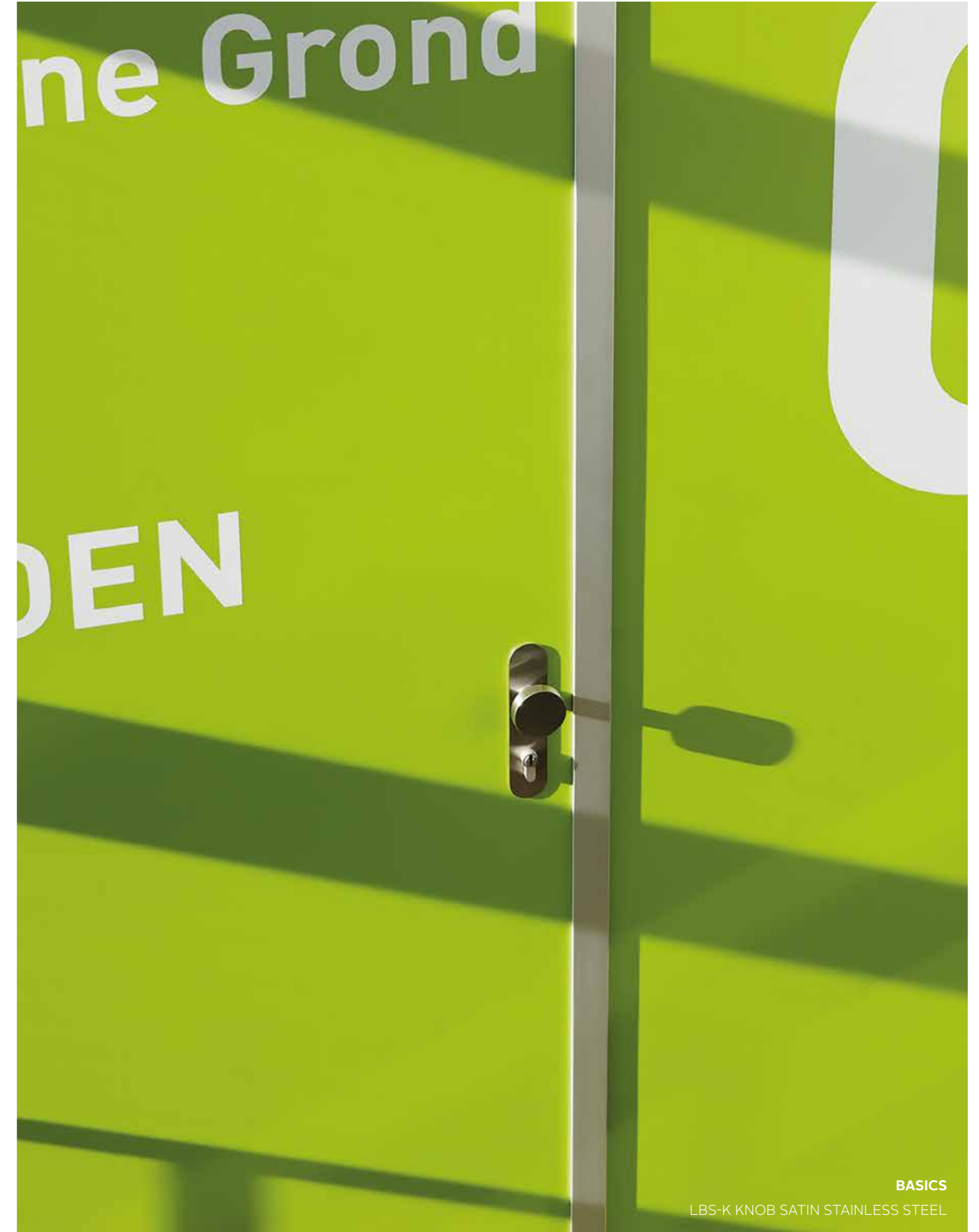

**BASICS**

LBS-K KNOB SATIN STAINLESS STEEL

# INDEX

1815	374	1932	383	1952-DK-O	412	BM230	339	EV40	302	FVL125/52	470	HP-RBT	406	KO-EV102	299
1815-DKLOCK-O	413	1932	384	ANTARES	560	BM500	338	EV9/128	301	FVL125-DK	475	JB100	172	KO-LBI	546
1815-DK-O	408	1932-DK-A	412	ARCTURUS	560	BVEIL	136	EV9/160	301	FVL125-DKLOCK	476	JB100-DK	188	KO-LBII	547
1910L	374	1932-DK-FA	413	BB100	122	BVEIL	300	EV9/96	301	FVL125P236	471	JB100-DKLOCK	191	KO-LBIII	547
1910L-DKLOCK-O	413	1932-DKLOCK-O	415	BB100-DK	134	BVEIL	358	EV9M	301	FVL85/40	468	JB100P236	172	KO-LBIIT	547
1910L-DK-O	408	1932-DK-O	410	BB100-DKLOCK	134	BVEIL	553	EVB52	297	FVL85-DK	474	JB20/320	215	KO-LBIV	547
1910M	441	1932M	442	BB100P236	122	BVEIL-KT	136	EVBNS2	296	FVL85-DKLOCK	475	JB200PD	173	KO-LBVI	547
1910T	374	1932T	385	BB101	122	BVEIL-KT	300	EVBY52	296	FV-RB	474	JB200V	196	KO-LBVII	547
1910T-DKLOCK-O	413	1932T-DKLOCK-O	415	BB101-DK	134	BVEIL-KT	358	EVWC52	297	FVT100/48	469	JB20M	218	KO-LBVIII	548
1910T-DK-O	408	1932T-DK-O	410	BB101-DKLOCK	135	BVEIL-KT	553	F507	423	FVT100-DK	475	JB230	223	KO-LBX	548
1921	375	1932XL	384	BB101P236	123	CAPELLA	560	F510	432	FVT100-DKLOCK	476	JB230PA	223	KO-LBXIV	548
1921-DKLOCK-O	414	1932XL DELUXE	384	BB102	123	CD55V	423	F511	432	FVT100V/48	483	JB320	197	KO-LBXV	548
1921-DK-O	409	1934	385	BB102-DK	134	EG230	513	F515	432	FVT100VP236	483	K-BM110	337	KO-LBXVII	548
1922	375	1934	386	BB102-DKLOCK	135	EG230PA	513	F535	432	FVT110/52	470	K-EG	513	KO-LBXVIII	548
1922	375	1934	387	BB102P236	123	EGB50	511	F535BI	432	FVT110-DK	475	K-FVL100	477	KO-LBXX	549
1922-DKLOCK-O	414	1934	388	BB103	124	EGBN50	511	F540	443	FVT110-DKLOCK	476	K-FVL110	477	KO-TB110	357
1922-DK-O	409	1934-DK-A	412	BB103-DK	134	EGBY50	511	F780	437	FVT110P236	470	K-FVL125	478	K-PBL15	40
1923	376	1934-DK-FA	413	BB103-DKLOCK	135	EG-DK	513	F788A	423	FVT110V/52	483	K-FVL85	477	K-PBL20	40
1923-DK-A	412	1934-DKLOCK-O	415	BB103P236	124	EG-DKLOCK	513	F788B	423	FVT110VP236	484	K-FVT100	477	K-PBL22	94
1923-DK-FA	412	1934-DK-O	410	BB104	124	EGP236	510	F788C	423	FVT125/52	471	K-FVT110	478	K-PBL23	94
1923-DKLOCK-O	414	1934M	442	BB105	125	EGQ50	510	FV190	482	FVT125-DK	475	K-FVT125	478	K-PBT15	40
1923-DK-O	409	1935	388	BB105-DK	134	EGR50	510	FV195	483	FVT125-DKLOCK	477	K-FVT85	477	K-PBT20	41
1924	376	1935	388	BB105-DKLOCK	135	EGWC50	512	FV195/128	482	FVT125P236	471	K-LSQ1	193	K-PBT22	94
1924-DKLOCK-O	414	1935	389	BB105P236	125	EGWCQ50	512	FV195/160	482	FVT125V/52	484	K-LSQII	193	K-PBT23	94
1924-DK-O	409	1935	389	BB200VA	136	E-LOCK8	41	FV195/192	482	FVT125VP236	484	K-LSQIII	194	K-VL115	195
1925	376	1935-DKLOCK-O	416	BB200VB	136	E-LOCK8	94	FV195/224	482	FVT85/40	468	K-LSQIIT	194	K-VL125	195
1925-DKLOCK-O	414	1935-DK-O	411	BB230	137	E-LOCK8	195	FV195/96	482	FVT85-DK	474	K-LSQIV	194	K-VT115	195
1925-DK-O	409	1938	389	BB230PA	138	E-LOCK8	299	FV22-28	480	FVT85-DKLOCK	476	K-LSQIVT	194	K-VT125	195
1927	377	1938	390	BB231	138	E-LOCK8	337	FV22-28KT	480	FVT85P236	483	K-LSQV	194	LBI-16	530
1927	377	1938	390	BB231PA	138	E-LOCK8	357	FV22-50	479	FVT85V/40	483	K-LSQVI	194	LBI-19	530
1927-DKLOCK-O	414	1938	390	BB25	137	E-LOCK8	478	FV22-50KT	480	FV-VEIL	479	KO-1910L	417	LBI-19P13	530
1927-DK-O	409	1938	391	BB25/160	137	E-LOCK8	513	FV22D	479	FVWC40	473	KO-1910T	417	LBI-DKLOCK-O	544
1929	377	1938-DKLOCK-O	416	BB25/320	137	E-LOCK8	549	FV22G	484	FVWC48	473	KO-1912	417	LBI-DK-O	541
1929	378	1938-DK-O	411	BB26/160	137	E-LOCK9	421	FV22V	479	GRR-VBWC	396	KO-1922	417	LBIF-DKLOCK-O	544
1929-DKLOCK-O	415	1938M	442	BB26/320	137	EV100/64	292	FV230	484	GRV-VBWC	396	KO-1923	417	LBIF-DK-O	541
1929-DK-O	410	1939	391	BB500	136	EV100-DKLOCK-O	298	FV230PA	485	GSNV38	393	KO-1924	418	LBII-16	531
1929M	442	1939-DKLOCK-O	416	BB501	136	EV100-DK-O	298	FV305	474	GSVB38	395	KO-1925	418	LBII-19	531
1930	378	1939-DK-O	411	BBB53	126	EV100P210	293	FV360	479	GSYV38	394	KO-1927	418	LBII-19P13	532
1930	378	1940	391	BBN53	125	EV101/64	294	FV38	484	HN80-O	433	KO-1929	418	LBII-19P236	532
1930	379	1940-DKLOCK-O	416	BBWC53	126	EV101-DKLOCK-O	298	FV48	481	HN80-1	433	KO-1929	418	LBII-19Q50	532
1930-DKLOCK-O	415	1940-DK-O	411	BBWCQ50	126	EV101-DK-O	298	FVB40	472	HN80-2	433	KO-1930	418	LBII-DKLOCK-O	544
1930-DK-O	410	1946	392	BBY53	126	EV101P211	295	FVB48	472	HN80-3	433	KO-1931	418	LBII-DK-O	541
1930XL	379	1946-DKLOCK-O	416	BM100	334	EV102/64	296	FVBN48	472	HN80-4	433	KO-1932	419	LBIIIT-DKLOCK-O	544
1930XL DELUXE	379	1946-DK-O	411	BM101	334	EV102-DKLOCK-O	298	FVBN48	472	HN80-5	434	KO-1932T	419	LBIIIT-DK-O	542
1931	380	1948	392	BM102	334	EV102-DK-O	298	FVBY40	472	HN80-6/9	434	KO-1934	419	LBIII-16	533
1931	380	1948-DKLOCK-O	416	BM103	335	EV102P211	296	FVBY48	472	HN80-7	434	KO-1935	419	LBIII-19	533
1931-DKLOCK-O	415	1948-DK-O	411	BM104	335	EV102VP211	302	FVBY52	296	HN80-8	434	KO-1938	419	LBIII-19P13	534
1931-DK-O	410	1949	392	BM110-DK	337	EV102VP211	302	FVL100/48	468	HN80-9/6	434	KO-1939	419	LBIII-DK-O	542
1932	380	1952	393	BM110-DKLOCK	337	EV200V	300	FVL100-DK	474	HP-RB	38	KO-1940	420	LBIII-DKLOCK-O	544
1932	381	1952 DELUXE	393	BM20/160	339	EV200V	300	FVL100-DKLOCK	476	HP-RB	92	KO-1946	420	LBIV-19	534
1932	382	1952-DK-A	412	BM20/320	339	EV231	302	FVL110/52	469	HP-RB	188	KO-1948	420	LBIV-DKLOCK-O	545
1932	383	1952-DK-FA	413	BM200V	338	EV231PA	302	FVL110-DK	475	HP-RB	474	KO-1952	420	LBIV-DK-O	542
1932	383	1952-DKLOCK-O	417	BM20M	339	EV25M	301	FVL110-DKLOCK	476	HP-RB	474	KO-1952	420	LBVI-19	534
						EV365	300	FVL110P236	469	HP-RB	541	KO-EV100	299	LBVI-DKLOCK-O	545
												KO-EV101	299		



# INDEX

LBVI-DK-O	542	LB507-50KT	425	LBP20	562	LSQIICBP236	175	LSQ69V	196	LSQBN50	335	LSQR-RB	188	MG1910/96	438
LBVII-19	535	LB507-50KT	554	LBPCG	564	LSQIIT-DK	189	LSQ70/160	216	LSQBN50	511	LSQSM-28	49	MG1910L	435
LBVII-19P236	535	LB507V	551	LBPG	564	LSQIIT-DKLOCK	191	LSQ70/224	216	LSQBY50	126	LSQSM-28	96	MG1910T	435
LBVII-19Q50	535	LB51	556	LBPH20	563	LSQIII	175	LSQ75D	197	LSQBY50	180	LSQSM-28	201	MG1923/128	439
LBVII-DKLOCK-O	545	LB520	556	LBPH30	563	LSQIII-DK	189	LSQ75G	221	LSQBY50	335	LSQSM-28	480	MG1923/160	439
LBVII-DK-O	542	LB52D	550	LBR32G	127	LSQIII-DKLOCK	192	LSQ75PD	180	LSQBY50	511	LSQSM-28KT	49	MG1923/96	439
LBVIII	536	LB52G	562	LBR32G	257	LSQIIIP236	175	LSQ75V	197	LSQHN150-O	203	LSQSM-28KT	97	MG1923A	435
LBVIII-DKLOCK-O	545	LB52PD	538	LBR32G	297	LSQIV	176	LSQ79	215	LSQHN150-1	203	LSQSM-28KT	201	MG1923B	421
LBVIII-DK-O	542	LB52V	550	LBR32G	540	LSQIV-DK	189	LSQ80	203	LSQHN150-2	204	LSQSM-28KT	481	MG1923B	435
LBX	536	LB535	556	LBR50EN	30	LSQIV-DKLOCK	192	LSQ80/96	216	LSQHN150-3	204	LSQSM-50	49	MG1923C	422
LBX-DKLOCK-O	545	LB535BI	556	LBR50EN	91	LSQIVF-DK	189	LSQ80/128	216	LSQHN150-4	204	LSQSM-50	96	MG1929	435
LBX-DK-O	543	LB53R	31	LBR50EN	127	LSQIVF-DKLOCK	192	LSQ80/160	217	LSQHN150-5	204	LSQSM-50	200	MG1929/128	439
LBXIV	536	LB53R	473	LBR50EN	297	LSQIVP236	176	LSQ92G	221	LSQHN150-6/9	204	LSQSM-50	480	MG1929/96	439
LBXIV-DKLOCK-O	545	LB55V	550	LBR50EN	473	LSQIVT-DK	190	LSQ92V	197	LSQHN150-7	204	LSQSM-50KT	49	MG1930/128	440
LBXIV-DK-O	543	LB57	437	LB-RB	541	LSQIVT-DKLOCK	192	LSQ125V	197	LSQHN150-8	205	LSQSM-50KT	96	MG1930/160	440
LBXV	537	LB57	561	LBS7676	566	LSQV	176	LSQ140/160	217	LSQHN150-9/6	205	LSQSM-50KT	200	MG1930/96	440
LBXV-DKLOCK-O	546	LB57S	437	LBS8989	566	LSQV-DK	190	LSQ140/320	217	LSQHN150-A	205	LSQSM-50KT	480	MG1930A	435
LBXV-DK-O	543	LB57S	561	LBSA7676	566	LSQV-DKLOCK	192	LSQ150	215	LSQHN150-B	205	LSQVEIL-B	199	MG1930B	422
LBXVII	537	LB60-28	555	LBSA8989	565	LSQVP236	177	LSQ151A	219	LSQHN150-C	205	LSQVEIL-B	424	MG1930B	436
LBXVII-DKLOCK-O	546	LB60-28KT	555	LBS-D	567	LSQVI	177	LSQ151B	219	LSQHN250-O	205	LSQVEIL-BKT	199	MG1932/128	440
LBXVII-DK-O	543	LB60-50	425	LBS-K	567	LSQVI-DK	190	LSQ160A	214	LSQHN250-1	206	LSQVEIL-BKT	424	MG1932/160	440
LBXVIII	537	LB60-50	554	LBS-L	567	LSQVI-DKLOCK	192	LSQ160B	214	LSQHN250-2	206	LSQVEIL-C	199	MG1932/96	440
LBXVIII-DKLOCK-O	546	LB60-50KT	425	LBSM-28	555	LSQVII-G	177	LSQ161	215	LSQHN250-3	206	LSQVEIL-C	338	MG1932A	436
LBXVIII-DK-O	543	LB60-50KT	554	LBSM-28KT	555	LSQ23	215	LSQ175	214	LSQHN250-4	206	LSQVEIL-C	424	MG1932B	436
LBXX	538	LB60G	563	LBSM-50	425	LSQ25	224	LSQ181A	219	LSQHN250-5	206	LSQVEIL-CKT	199	MG1932C	436
LBXX-DKLOCK-O	546	LB60V	550	LBSM-50	555	LSQ27	214	LSQ230	223	LSQHN250-6/9	206	LSQVEIL-CKT	338	MG1934/128	441
LBXX-DK-O	543	LB64	563	LBSM-50KT	432	LSQ40V	220	LSQ230PA	224	LSQHN250-7	207	LSQVEIL-CKT	425	MG1934/160	441
LBXXI	538	LB65	561	LBSM-50KT	555	LSQ40VP236	220	LSQ231	224	LSQHN250-8	207	LSQWC50	180	MG1934/96	441
LBXXI-DKLOCK-O	546	LB701V	551	LBT	552	LSQ45	221	LSQ231PA	224	LSQHN250-9/6	207	LSQWC50	336	MG1934C	422
LBXXI-DK-O	544	LB702V	551	LBT-S	552	LSQ46	225	LSQ254	188	LSQHN250-A	207	LZ100	256	MG1934C	436
LB10	564	LB70V/A	550	LBT-T	552	LSQ50	203	LSQ305	188	LSQHN250-B	207	LZ100-DKLOCK-O	258	MG1938	436
LB170	561	LB80V	550	LBU	553	LSQ50-28	201	LSQ319	219	LSQHN250-C	207	LZ100-DK-O	258	MG1938/128	441
LB22	564	LB85	565	LBU-90	553	LSQ50-28KT	201	LSQ380	50	LSQK-25	218	LZ100OMA	256	MG1938/96	441
LB230	563	LBB50	539	LBVEIL	424	LSQ50-50	200	LSQ380	202	LSQK-160	218	LZ100OMA-DKLOCK-O	258	MKK40	442
LB230PA	563	LBHN100-O	556	LBVEIL	554	LSQ50-50KT	200	LSQ380BI	50	LSQK-170	218	258	MN1031	437	
LB231	564	LBHN100-1	557	LBVEIL507/50	425	LSQ51D	196	LSQ380BI	202	LSQKY	181	LZ100OMA-DK-O	258	MN800/128	438
LB231PA	564	LBHN100-2	557	LBVEIL-KT	424	LSQ51G	220	LSQ390	203	LSQP100A	221	LZ185	259	MN800/32	438
LB25	565	LBHN100-3	557	LBVEIL-KT	554	LSQ51PD	179	LSQ620	202	LSQP100B	221	LZ185MA	259	MN926	437
LB29	437	LBHN100-4	557	LBWC50	539	LSQ51V	196	LSQ620BI	202	LSQP100C	221	LZ200PD	256	MNC50	394
LB29	561	LBHN100-5	557	LBWC50D	540	LSQ54	214	LSQ621	202	LSQP100D	222	LZ200V	259	MPK	443
LB30	565	LBHN100-6/9	557	LBY50	539	LSQ54S	214	LSQ621BI	202	LSQP100E	222	LZ201V	259	MRB38	395
LB305	541	LBHN100-7	558	LBY50D	539	LSQ60-28	201	LSQ1035	198	LSQP100F	222	LZ25M	259	MRB50	396
LB306	565	LBHN100-8	558	LSQI	173	LSQ60-28KT	201	LSQ1045	198	LSQP100G	222	LZ30M	259	MRC50MWC	397
LB39	559	LBHN100-9/6	558	LSQI-DK	188	LSQ60-50	199	LSQ1055	198	LSQP100H	222	LZ35M	260	MRCB50	396
LB41	561	LBHN100-A	558	LSQI-DKLOCK	191	LSQ60-50KT	199	LSQ1065	198	LSQP100I	222	LZBB50	257	MRK/50	442
LB432	565	LBHN100-B	558	LSQIP236	173	LSQ60G	220	LSQ1075	198	LSQP100J	223	LZBN50	257	MRK37MWC	396
LB47V	562	LBHN100-C	558	LSQII	174	LSQ60V	196	LSQ8040	216	LSQP100K	223	LZBY50	257	MRKB37	395
LB50	556	LBHN100-D	559	LSQII-DK	189	LSQ60V	423	LSQB50	126	LSQP100L	223	LZWC50	257	MRKG/50	443
LB501	551	LBHN100-E	559	LSQII-DKLOCK	191	LSQ61G	220	LSQB50	180	LSQR32G	31	LZWC50B	257	MRLMWC	397
LB501VP13	562	LBN50	539	LSQIIP236	174	LSQ61V	196	LSQB50	336	LSQR32G	181	MG1910/128	438	MRR38WC	397
LB502	551	LBN50D	539	LSQIICB	174	LSQ65	203	LSQB50	511	LSQR32G	473	MG1910/160	438	MRR50MWC	397
LB503	551	LBP10	562	LSQIICB-DK	189	LSQ65	433	LSQB50	125	LSQR50EN	181	MG1910/192	438	MRV45MWC	397
LB507-50	554	LBP15	562	LSQIICB-DKLOCK	191	LSQ69G	220	LSQBN50	180	LSQR60	181	MG1910/224	439	MRVB45	396

# INDEX

# INDEX

MSN38	394	PB23RU-R	92	PBN50	30	RU-1923	407
MSN50	394	PB25	58	PBN50	90	RU-1932	407
MSNK37		PB30	53	PB-RB	38	RU-1934	408
393		PB300	56	PBT100G	52	RU-1938	408
MSNV45	394	PB301	56	PBT100V	48	RU-UNI	408
MSY50	395	PB302	56	PBT15/50	25	SIRIUS	560
MSYK37	394	PB303	56	PBT15-DK	38	SVEIL	424
MSYV45	395	PB305	38	PBT15-DKLOCK	39	TB100	356
MYC50	395	PB30W	54	PBT15P236	25	TB110-DKLOCK-O	357
P-1923	420	PB400	48	PBT15P236	52	TB110-DK-O	357
P-1925	420	PB422	95	PBT15V/50	51	TB20/160	359
P-1931	421	PB423	95	PBT15XL/50	26	TB20/360	359
P-1932	421	PB450	56	PBT15XLP236	26	TB200V	358
P-1934	421	PB500	55	PBT20/50	28	TB20M	359
P-1952	421	PB500	57	PBT20-DK	39	TB230	359
PA707	422	PB501	57	PBT20-DKLOCK	40	TB50	358
PA752	422	PB502	57	PBT20P236	29	TB500	358
PB100	57	PB503	57	PBT20V/50	52	TB501	358
PB101	57	PB51	52	PBT20VP236	52	TBB50	356
PB102	58	PB52	50	PBT20XL/50	29	TBN50	356
PB103	58	PB60	52	PBT20XLP236	29	TBWC50	356
PB105	53	PB75	54	PBT22/50	88	TBWC50B	357
PB120	41	PB750	55	PBT22-DK	92	TBY50	356
PB14	51	PB775	55	PBT22-DKLOCK	93	V22-50	200
PB140	53	PB9	51	PBT22G	100	V22-50KT	200
PB195/128	51	PB90	53	PBT22P236	89	V22V	197
PB195/160	51	PBB50	30	PBT22V/50	99	V230	224
PB195/96	51	PBB50	91	PBT22VP236	99	V230PA	224
PB200	58	PBKY	30	PBT23/50	90	V35/128	217
PB201	58	PBL15/50	24	PBT23-DK	93	V35/160	217
PB20-28	49	PBL15-DK	38	PBT23-DKLOCK	93	V35/192	218
PB20-28KT	49	PBL15-DKLOCK	39	PBT23G	100	V35/224	218
PB20-50	48	PBL15F-DK	38	PBT23P236	90	V35/96	217
PB20-50KT	48	PBL15F-DKLOCK	39	PBT23V/50	95	V360	198
PB22/160	98	PBL15P236	24	PBT23V/50	99	V50	219
PB22/320	98	PBL15XL/50	24	PBT23VP236	99	V60	219
PB22/480	98	PBL15XLP236	25	PBVEIL	48	VEGA	560
PB220	479	PBL20/50	26	PBVEIL	95	VL115	178
PB22M	99	PBL20-DK	39	PBVEIL-KT	48	VL115-DK	190
PB23/160	98	PBL20-DKLOCK	40	PBVEILKT	95	VL115-DKLOCK	193
PB23/320	98	PBL20F-DK	39	PBWC23	91	VL125	178
PB23/480	98	PBL20F-DKLOCK	40	PBWC50	30	VL125-DK	190
PB230	53	PBL20P236	27	PBY50	30	VL125-DLOCK	193
PB230PA	53	PBL20XL/50	27	PBY50	90	VL125P236	179
PB231	100	PBL20XLP236	28	RB-1923	406	VT115	178
PB231PA	100	PBL22/50	88	RB-1932	406	VT115-DK	190
PB23-28	96	PBL22-DK	92	RB-1934	406	VT115-DKLOCK	193
PB23-28KT	96	PBL22-DKLOCK	93	RB-1938	406	VT125	179
PB23-50	95	PBL22P236	88	RBA-1923	407	VT125-DK	191
PB23-50KT	96	PBL23/50	89	RBA-1932	407	VT125-DKLOCK	193
PB23M	99	PBL23-DK	93	RBA-1934	407	VWC50	181
PB23-RB	92	PBL23-DKLOCK	93	RBA-UNI	407	WCO	397
PB23RU-L	92	PBL23P236	89	RB-UNI	406		

## COLOFON | COLOPHON

### REDACTIE | EDITING

FORMANI HOLLAND B.V., MAASTRICHT-AIPOINT, THE NETHERLANDS

### ART DIRECTION

NIELS MAIER (STUDIO NIELS), MAASTRICHT, THE NETHERLANDS  
WWW.MANAWASHERE.COM, HEERLEN, THE NETHERLANDS

### VORMGEVING | DESIGN

WWW.MANAWASHERE.COM, HEERLEN, THE NETHERLANDS  
NIELS MAIER (STUDIO NIELS), MAASTRICHT, THE NETHERLANDS (COVER & PHOTOSHOOTS)

### FOTOGRAFIE | PHOTOGRAPHY

TIJMEN BALLIEUX, THE NETHERLANDS  
JESAJA HUTUBESSY, THE NETHERLANDS  
TYCHO MERIJN ROEST, THE NETHERLANDS  
SERGE TECHNAU, THE NETHERLANDS  
ERIC KLEINBERG, THE NETHERLANDS  
SIMON DEVITT, NEW ZEALAND  
WILLIAM RUTTEN, THE NETHERLANDS  
PETER BAAS, THE NETHERLANDS  
FAISAL FAROOQUI, PAKISTAN  
ERWIN OLAF, THE NETHERLANDS  
DANIEL ALEA, SPAIN  
FRANK TIELEMANS, BRAZIL  
HERMAN VAN HEUSDEN, THE NETHERLANDS  
LEAH HAWKER, SOUTH AFRICA  
ANGELA MOORE, UNITED KINGDOM  
MATTHIJS VAN ROON, THE NETHERLANDS  
HUGO THOMASSEN, THE NETHERLANDS  
KENNETH TAN, THE NETHERLANDS (PRODUCT PHOTOGRAPHY)  
MULTIEMDIA STUDIO JANSSEN, THE NETHERLANDS (PRODUCT PHOTOGRAPHY)

### TEKST | TEXT

NICOLINE WISSE SMIT, WIS & WAARACHTIG, THE NETHERLANDS (INTRO & PHOTOSHOOT STORIES)  
FORMANI HOLLAND B.V., MAASTRICHT-AIRPORT, THE NETHERLANDS

### DRUKWERK | PRINTING

MODDERKOLK GRAFISCHE PROJECTEN, EDE, THE NETHERLANDS

### TEKENINGEN | DRAWINGS

CHRISTIAN BRIMBOIS - FORMANI HOLLAND B.V., MAASTRICHT-AIRPORT, THE NETHERLANDS

### VERTALINGEN | TRANSLATIONS

DUO VERTAALBURO, MAASTRICHT, THE NETHERLANDS







FORMANI®

FORMANI HOLLAND B.V. EUROPALAAN 12 6199 AB MAASTRICHT-AIRPORT THE NETHERLANDS  
T +31 (0)43 308 90 00 F +31 (0)43 364 88 28 INFO@FORMANI.COM FORMANI.COM