

VERUM

ITALY

Indice dei contenuti / *Index of contents*

Verum Italy	02 – 03
Nuda	04 – 09
Maniglie / <i>Handles</i>	16 – 17
Pure	18 – 19
Baar	20 – 21
Lieve	22 – 23
Pepe	24 – 25
Wind	26 – 27
Atlanta	28 – 29
Pomoli / <i>Knobs</i>	30 – 31
Lui	32 – 33
Cham	34 – 35
Soap	36 – 37
Lui Marmo	38 – 39
Nottolini / <i>Privacy sets</i>	40 – 43
Finestre / <i>Windows</i>	44 – 47
Porta blindata / <i>Armoured door</i>	48 – 49
Accessori / <i>Accessories</i>	50 – 59
Ambienti / <i>Environments</i>	60 – 65
Vetro / <i>Glass</i>	66 – 67
Yoyo	68
Tondo	69
Vulcano sliding	70
Cham sliding	71
Piastre porte vetro / <i>Glass door plates</i>	72 – 73
Total Glass	74 – 75
Glass Frame	76 – 77
Vulcano Lock	78 – 79
Finiture / <i>Finishes</i>	80 – 83
Stoppino	84 – 85
Stoppino Open	86 – 93
Stoppino X	94 – 99
Stoppino Close	100 – 105
Profili decorativi / <i>Decorative profiles</i>	106 – 111
Espositori commerciali / <i>Commercial displays</i>	112 – 115
Condizioni di vendita / <i>Term of sales</i>	116 – 117

VERUM

ITALY

MADE IN ITALY

**When passion
meets research,
when design
meets innovation:
that's where
true italian style
creates efficient
beautiful solutions
for living spaces.**

Verum Italy è un acceleratore di idee, un'azienda in cui innovazione e ricerca si concretizzano per realizzare prodotti unici: soluzioni intelligenti per gli spazi abitativi. Verum Italy opera nel mondo del design per offrire al mercato prodotti inediti e rivoluzionari garantendo estetica e funzionalità.

Verum Italy esporta in numerosi Paesi del mondo la qualità tecnica italiana supportata da brevetti a valenza internazionale.

Verum Italy is an ideas accelerator, a company where innovation and research meet to create unique products: smart solutions for living spaces. Verum Italy operates in the design field to offer to the market original and revolutionary products characterised by design and functionality. Verum Italy operates worldwide exporting Italian quality and know-how supported by international patents.

**nu
da.**

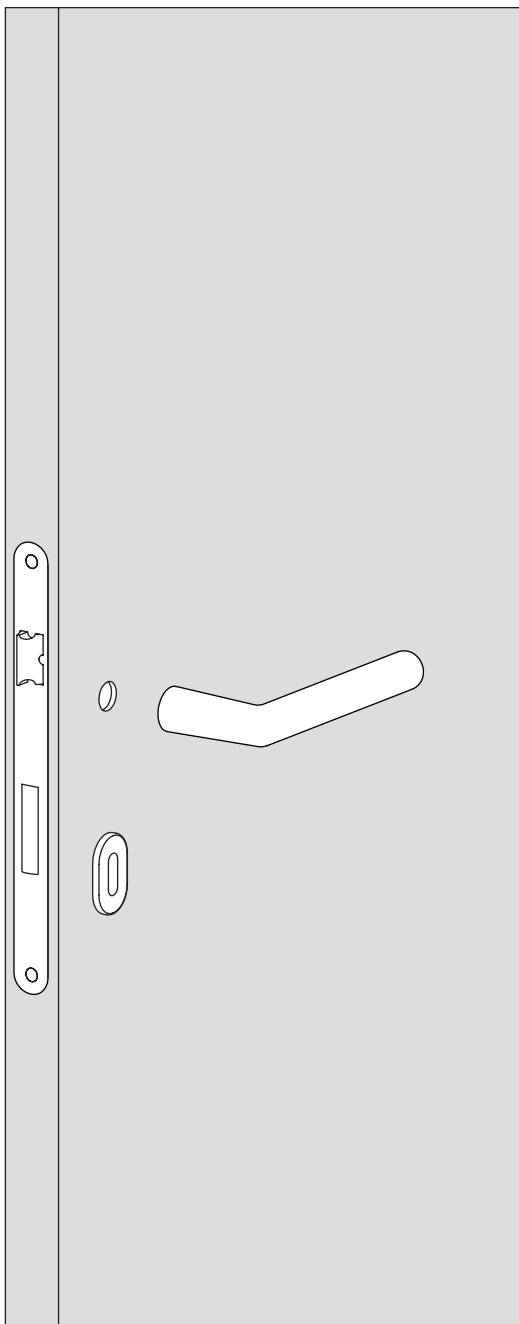
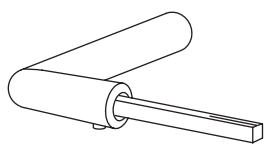

Sistema brevettato
Patented system

**L'unica maniglia
senza rosetta**

**The only handle
without the rose**

Nuda è una collezione di maniglie che utilizza un innovativo sistema brevettato che ne permette il fissaggio senza rosetta, perfetto per un design minimalista. Il montaggio avviene in pochi secondi senza necessitare di competenze tecniche o attrezzature specifiche. Nuda è adattabile a ogni spessore e tipologia di porta. Le sue funzionalità sono garantite secondo DIN 1906.

Nuda is a collection of handles with an innovative patented system whose assembly does not require anymore the rose. A minimalist and design solution for any door. The assembly is very quick, it can be done in few seconds and it does not require any specific technical skills and tools. Nuda can be adapted to any thickness and typology of door. The functionality of Nuda is guaranteed by DIN 1906.

**Less is more,
Nuda is magic**

Fissaggio senza viti nel pannello porta

**Assemblaggio rapido stringendo due grani,
disponibile anche versione a un grano**

**Adattabile a diversi fori con diametri da 16 a 30 mm
0,63 inch – 1,18 inch**

Sistema brevettato testato oltre 200.000 cicli

Cuscinetto a sfera testato oltre 1.000.000 cicli

**Disponibili accessori coordinati per finestre
e porte blindate**

Prodotto in Italia

Fixing without screws in the door panel

**Fast assembly screwing two grains,
one grain version available on demand**

**Suitable for different holes diameter,
from 16 mm to 30 mm / 0,63 - 1,18 inch**

**Patented system tested over 200.000 cycles
according to European locks standards**

Ball bearing tested over 1.000.0000 cycles

**Coordinated accessories for windows
and armoured doors available**

Made in Italy

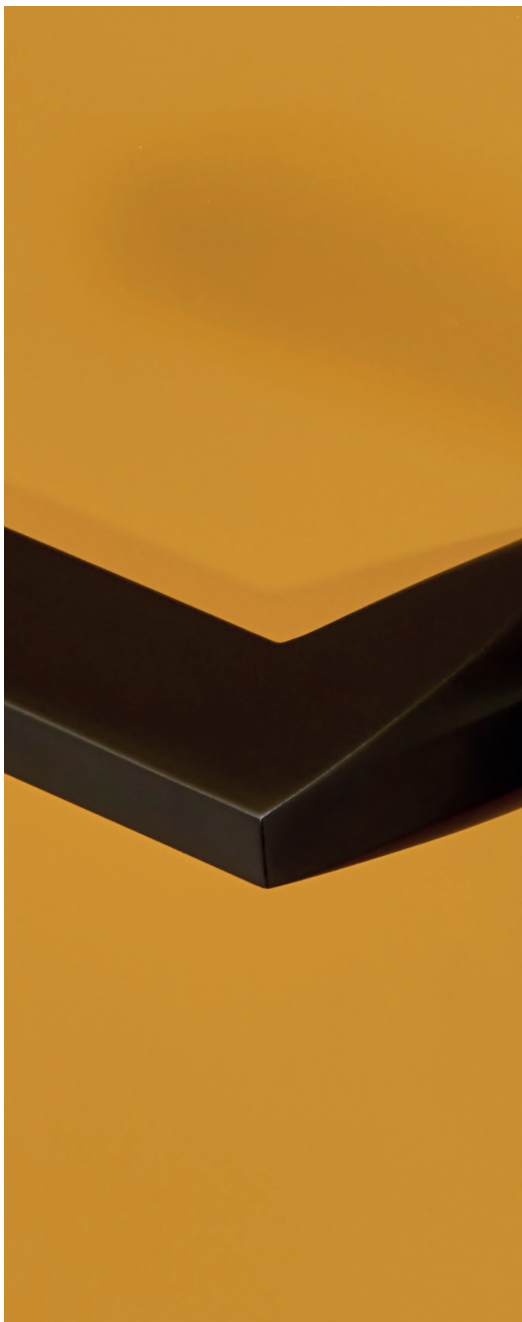

Maniglia Atlanta
Atlanta Handle



Maniglia Pure
Pure Handle

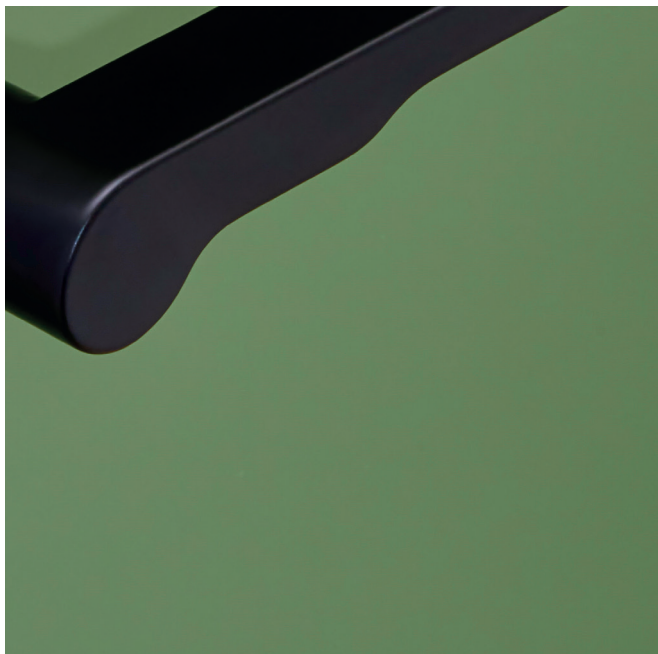

Maniglia Wind
Wind Handle

Pomolo Soap
Soap Knob





Pomolo Lui
Lui Knob

Maniglia Pepe
Pepe Handle



Maniglie

Handles



Pure

18



Baar

20



Lieve

22



Pepe

24



Wind

26



Atlanta

28

Pure

Cod. 127001

Design Mattia Ferremi

Finiture / Finishes

- cod. 14 Cromo Satinato / *Satin Chrome*
- cod. 39 Cromo Lucido / *Polished Chrome*
- cod. 18 Nero Etna / *Etna Black*
- cod. 49 Bianco Monviso / *Monviso White*
- cod. 21 Bronzo Yester / *Yester Bronze*

$\frac{\text{mm}}{\text{inch}}$

Porta / Door

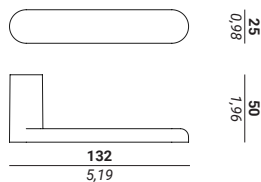

Quadro / Spindle \square 8 / 0,31

Finestra / Window

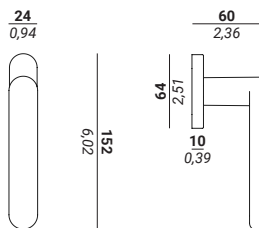

Bocchetta / Escutcheon

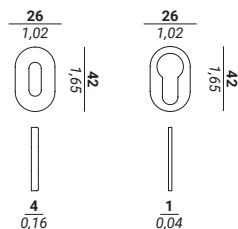



Baar

Cod. 127006

Design Alessandro Stabile

Finiture / Finishes

- cod. 14 Cromo Satinato / *Satin Chrome*
- cod. 39 Cromo Lucido / *Polished Chrome*
- cod. 18 Nero Etna / *Etna Black*
- cod. 49 Bianco Monviso / *Monviso White*
- cod. 21 Bronzo Yester / *Yester Bronze*

$\frac{\text{mm}}{\text{inch}}$

Porta / Door

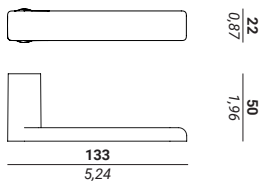

Quadro / Spindle \square 8 / 0,31

Finestra / Window

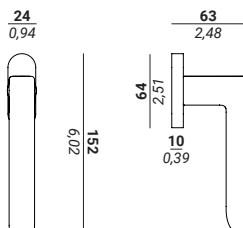

Bocchetta / Escutcheon

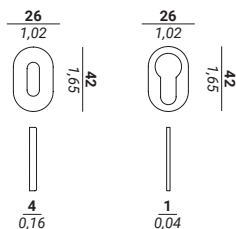



Lieve

Cod. 127005

Design Alessandro Stabile

Finiture / Finishes

- cod. 14 Cromo Satinato / *Satin Chrome*
- cod. 39 Cromo Lucido / *Polished Chrome*
- cod. 18 Nero Etna / *Etna Black*
- cod. 49 Bianco Monviso / *Monviso White*
- cod. 21 Bronzo Yester / *Yester Bronze*

$\frac{\text{mm}}{\text{inch}}$

Porta / Door

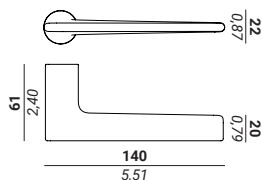

Quadro / Spindle \square 8 / 0,31

Finestra / Window

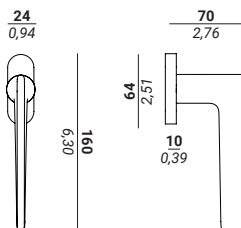

Bocchetta / Escutcheon

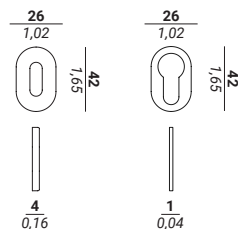



Pepe

Cod. 127007

Design Alessandro Stabile

Finiture / Finishes

- cod. 14 Cromo Satinato / *Satin Chrome*
- cod. 39 Cromo Lucido / *Polished Chrome*
- cod. 18 Nero Etna / *Etna Black*
- cod. 49 Bianco Monviso / *Monviso White*
- cod. 21 Bronzo Yester / *Yester Bronze*

$\frac{\text{mm}}{\text{inch}}$

Porta / Door

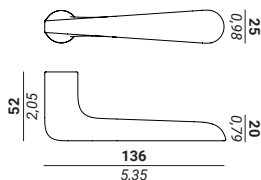

Quadro / Spindle \square 8 / 0,31

Finestra / Window

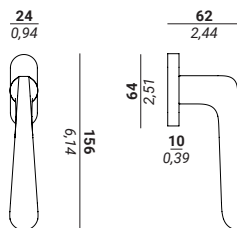

Bocchetta / Escutcheon

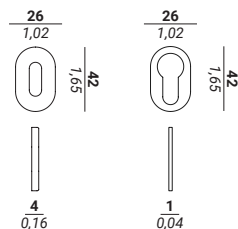



Wind

Cod. 127002

Design Mattia Ferremi

Finiture / Finishes

- cod. 14 Cromo Satinato / *Satin Chrome*
- cod. 39 Cromo Lucido / *Polished Chrome*
- cod. 18 Nero Etna / *Etna Black*
- cod. 49 Bianco Monviso / *Monviso White*
- cod. 21 Bronzo Yester / *Yester Bronze*

$\frac{\text{mm}}{\text{inch}}$

Porta / Door

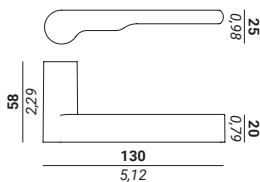

Quadro / Spindle \square 8 / 0,31

Finestra / Window

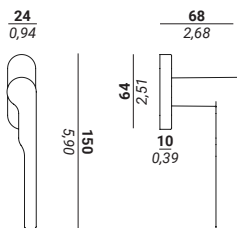

Bocchetta / Escutcheon

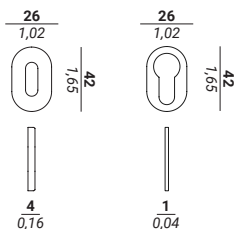



Atlanta

Cod. 127003

Design Nuda R&D

Finiture / Finishes

- cod. 14 Cromo Satinato / *Satin Chrome*
- cod. 39 Cromo Lucido / *Polished Chrome*
- cod. 18 Nero Etna / *Etna Black*
- cod. 49 Bianco Monviso / *Monviso White*
- cod. 21 Bronzo Yester / *Yester Bronze*

$\frac{\text{mm}}{\text{inch}}$

Porta / Door

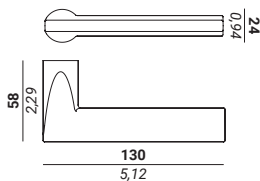

Quadro / Spindle \square 8 / 0,31

Finestra / Window

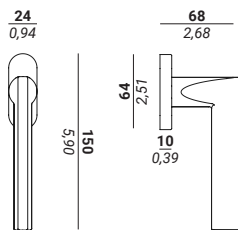

Bocchetta / Escutcheon

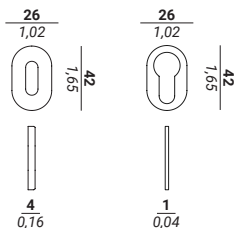

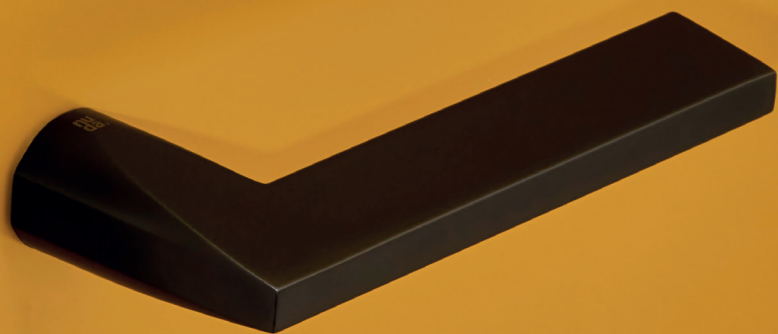

Pomoli

Knobs



Lui

32



Cham

34



Soap

36



Lui Marmo

38

Cod. 127004

Design Alessandro Stabile

Set pomoli girevoli /
Turnable knob set

Finiture per alluminio /
Finishes for aluminium

cod. 80 Grigio Milano / Milan Grey
cod. 18 Nero Etna / Etna Black
cod. 49 Bianco Monviso / Monviso White

Finiture per ottone /
Finishes for brass

cod. 14 Cromo Satinato / Satin Chrome
cod. 21 Bronzo Yester / Yester Bronze
cod. 37 Ottone Lucido / Polished Brass

Porta / Door

Bocchetta / Escutcheon

$\frac{\text{mm}}{\text{inch}}$



Quadro / Spindle 8 / 0,31

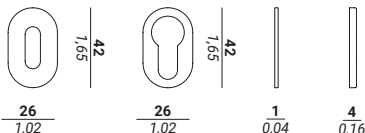

Disponibili anche / Also available

Set pomolo fisso singolo /
Single fixed knob set

Set pomolo singolo fisso
fissaggio frontale /
Single fixed knob set
frontal fixing

Set pomolo fisso doppio /
Double fixed knob set

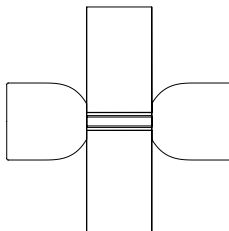
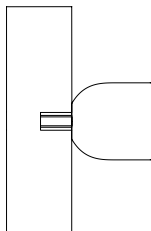
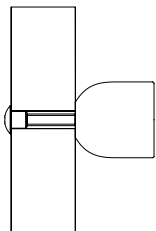



Cham

Cod. 127008

Design Nuda R&D

Set pomoli girevoli /
Turnable knob set

Finiture per alluminio /
Finishes for aluminium

cod. 80 Grigio Milano / Milan Grey
cod. 18 Nero Etna / Etna Black
cod. 49 Bianco Monviso / Monviso White

Finiture per ottone /
Finishes for brass

cod. 14 Cromo Satinato / Satin Chrome
cod. 21 Bronzo Yester / Yester Bronze
cod. 37 Ottone Lucido / Polished Brass

Porta / Door

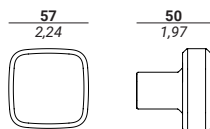

Quadro / Spindle \square 8 / 0,31

Bocchetta / Escutcheon

mm
inch

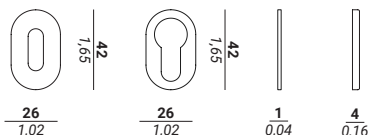

Disponibili anche / Also available

Set pomolo fisso singolo /
Single fixed knob set

Set pomolo singolo fisso
fissaggio frontale /
Single fixed knob set
frontal fixing

Set pomolo fisso doppio /
Double fixed knob set

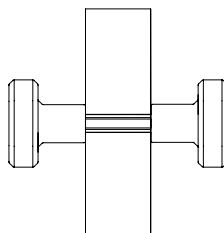
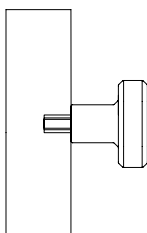
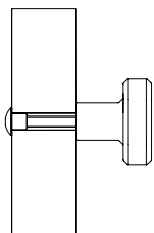



Soap

Cod. 127009

Design Nuda R&D

Set pomoli girevoli /
Turnable knob set

Finiture per alluminio /
Finishes for aluminium

cod. 80 Grigio Milano / Milan Grey
cod. 18 Nero Etna / Etna Black
cod. 49 Bianco Monviso / Monviso White

Finiture per ottone /
Finishes for brass

cod. 14 Cromo satinato / Satin Chrome
cod. 21 Bronzo Yester / Yester Bronze
cod. 37 Ottone Lucido / Polished Brass

Porta / Door

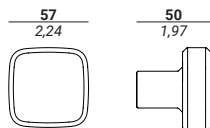

Quadro / Spindle \square 8 / 0,31

Bocchetta / Escutcheon

mm
inch

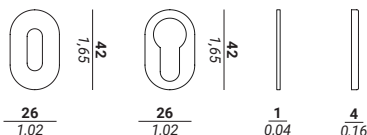

Disponibili anche / Also available

Set pomolo fisso singolo /
Single fixed knob set

Set pomolo singolo fisso
fissaggio frontale /
Single fixed knob set
frontal fixing

Set pomolo fisso doppio /
Double fixed knob set

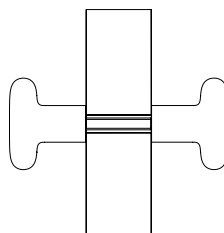
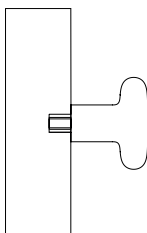
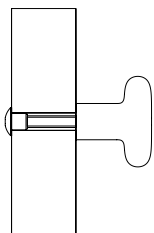



Lui Marmo

Cod. 127010

Design Alessandro Stabile

Set pomoli girevoli /
Turnable knob set

Per progetti speciali è possibile realizzare il modello Lui Marmo in marmo bianco lucido di Carrara e marmo nero lucido Marquinia.

For special projects, it is possible to provide model Lui Marmo in polished white Carrara marble and polished black Marquinia marble.

Porta / Door



Quadro / Spindle \square 8 / 0,31

Bocchetta / Escutcheon

mm
inch

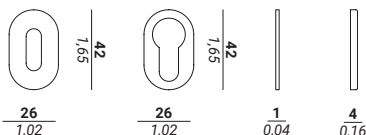

Disponibili anche / Also available

Set pomolo fisso singolo /
Single fixed knob set

Set pomolo singolo fisso
fissaggio frontale /
*Single fixed knob set
frontal fixing*

Set pomolo fisso doppio /
Double fixed knob set

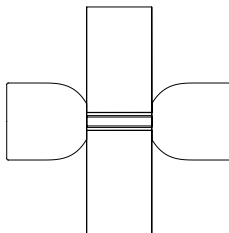
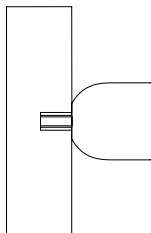
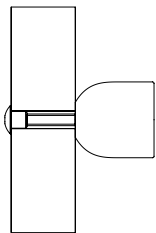

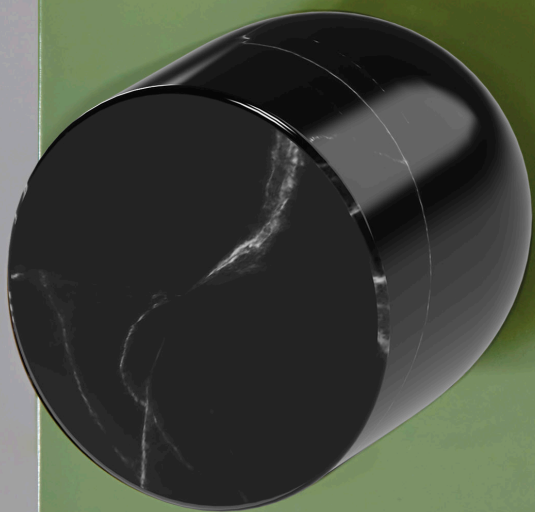

Nottolini

Privacy sets

Nuda offre dei nottilini dedicati da abbinare al design delle proprie maniglie per avere una continuità di immagine. Il nottolino diviene elemento tecnico, funzionale ed estetico al contempo.



Nuda offers privacy sets to be specifically matched to the design of the handle and have a continuity in terms of image. The privacy set becomes a technical, functional and aesthetic element at the same time.

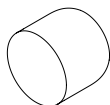

27
1,06

23
0,90



14
0,55

33
1,30



mm
inch

Cod. 128015

Cod. 128007

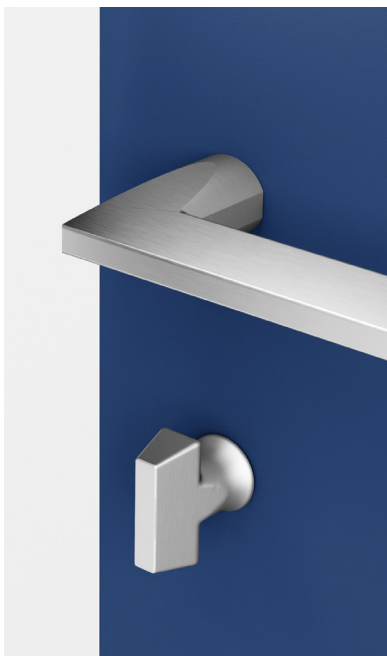

Nottolino Punto può essere abbinato a tutte le maniglie e pomoli Nuda / Punto privacy set can be combined to every Nuda handle and knob

Spessore pannello tra 40 - 55 mm (1,57 - 2,16 inch) / Panel thickness 40 - 55 mm (1,57 - 2,16 inch)

**Foro richiesto 16 mm / 0,62 inch
Required hole 16 mm / 0,62 inch**

Quadro / Spindle ☒ 6 mm / 0,24 inch

Nottolino per maniglia Atlanta / Privacy set for Atlanta handle

**Spessore pannello tra 40 - 55 mm (1,57 - 2,16 inch)
Panel thickness 40 - 55 mm (1,57 - 2,16 inch)**

**Foro richiesto 20 mm / 0,79 inch
Required hole 20 mm / 0,79 inch**

Quadro / Spindle ☒ 6 mm / 0,24 inch

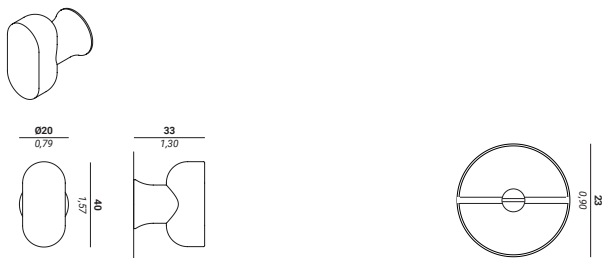

Cod. 128006



**Nottolino per maniglia Pure e Wind /
Privacy set for Pure and Wind handle**

**Spessore pannello tra 40 e 55 mm
(1,57 e 2,16 inch)
Panel thickness 40 and 55 mm
(1,57 and 2,16 inch)**

**Foro richiesto 20 mm / 0,79 inch
Required hole 20 mm / 0,79 inch**

Quadro / Spindle ☒ 6 mm / 0,24 inch

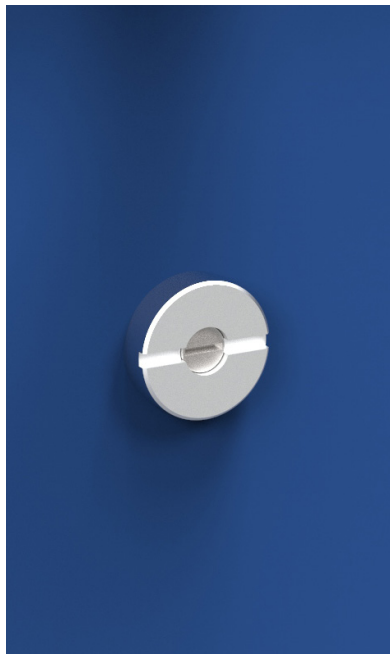

**Lato esterno nottolino Punto
External side Punto privacy set**

Finiture / Finishes

**cod. 14 Cromo Satinato / Satin Chrome
cod. 39 Cromo Lucido / Polished Chrome
cod. 49 Bianco Monviso / Monviso White
cod. 18 Nero Etna / Etna Black
cod. 21 Bronzo Yester / Yester Bronze
cod. 80 Grigio Milano / Milan Grey**

Finestre

Windows

Nuda offre una soluzione di estremo minimalismo anche per la finestra. La maniglia diviene così elemento di sintesi tra porta e finestra.



Nuda offers a solution of extreme minimalism also for the window. The handle becomes a perfect cohesion element between the door and the window.

Slim 4 movimenti / Slim 4 movements

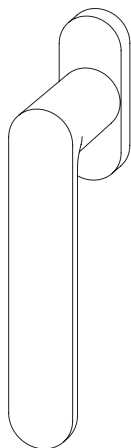

Pure
Cod. 129001

Wind
Cod. 129002

Atlanta
Cod. 129003

Lieve
Cod. 129005

Baar
Cod. 129006

Pepe
Cod. 129007

Standard 4 movimenti / Standard 4 movements

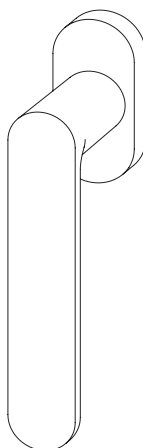

Pure
Cod. 129201

Wind
Cod. 129202

Atlanta
Cod. 129203

Lieve
Cod. 129205

Baar
Cod. 129206

Pepe
Cod. 129207

24
0,94

mm
inch

30
1,18

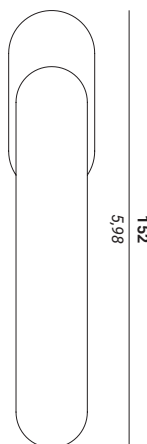
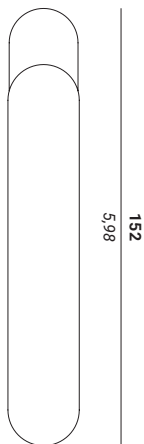

Finiture / Finishes

cod. 14 Cromo Satinato / *Satin Chrome*
cod. 39 Cromo Lucido / *Polished Chrome*
cod. 49 Bianco Monviso / *Monviso White*
cod. 18 Nero Etna / *Etna Black*
cod. 21 Bronzo Yester / *Yester Bronze*
cod. 80 Grigio Milano / *Milan Grey*

Maniglioni alzanti scorrevoli / Lift slide handles

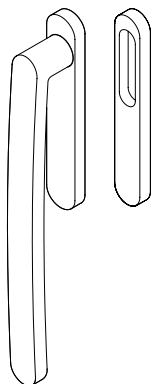

Round

Cod. 12501401
Versione maniglione con
nicchia /
*Lift slide handle with niche
version*

Cod. 12501402
Versione doppio maniglione
foro cilindro /
*Double lift slide handle
cylinder hole version*

Quadro 10 mm / 0,39 inch
Spindle 10mm / 0,39 inch

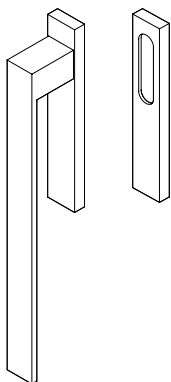
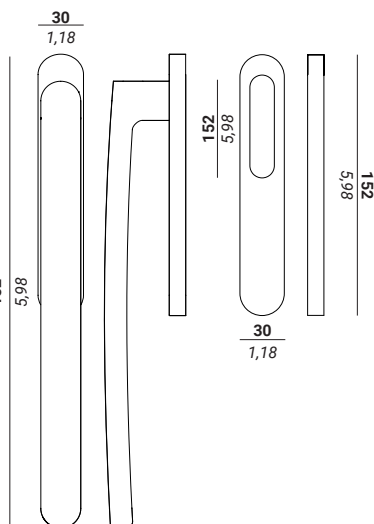

Square

Cod. 12501501
Versione maniglione con
nicchia /
*Lift slide handle with niche
version*

Cod. 12501502
Versione doppio
maniglione foro cilindro /
*Double lift slide handle
cylinder hole version*

Quadro 10 mm / 0,39 inch
Spindle 10mm / 0,39 inch

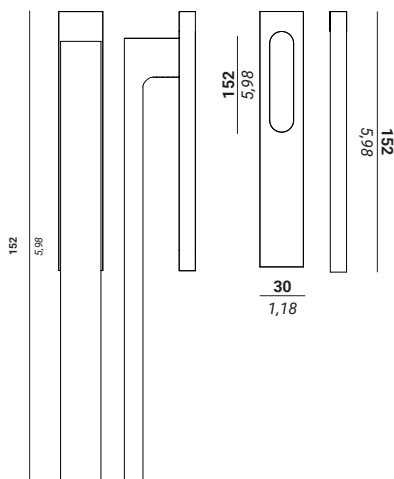

Porta blindata

Armoured door

Kit mezza maniglia per porta blindata / Half handle kit for armoured door

Cod. 130

Kit mezza maniglia con rondella e quadro ad espansione per porta blindata / Half handle kit with washer and expansion-knurled spindle for armoured door



**Materiale /
Material**

**Zama /
Zamak**

Finiture / Finishes

cod. 14 Cromo Satinato /
Satin Chrome

cod. 39 Cromo Lucido /
Polished Chrome

cod.18 Nero Etna /
Etna Black

cod. 49 Bianco Monviso /
Monviso White

cod.21 Bronzo Yester /
Yester Bronze

Kit mezza maniglia per porta blindata con rondella 30 mm / 1,18 inch premontata e quadro a espansione 8 mm / 0,31 inch di lunghezza 85 mm / 3,35 inch

Half handle kit for armoured door with 30 mm / 1,18 inch washer and expansion-knurled 8 mm / 0,31 inch spindle of 85 mm / 3,35 inch length.

Accessori

Accessories

La collezione Nuda include un'ampia gamma di accessori per poter soddisfare le esigenze tecniche per ogni tipologia porta.



Nuda collection includes a wide range of accessories to meet all technical needs for every door.

Bocchette e rondelle / Escutcheons and washers

mm
inch

A. Bocchetta Slim / Slim escutcheon

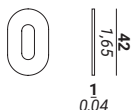

Foro chiave /
Key hole
Cod. 128002

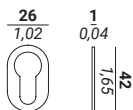

Foro cilindro /
Cylinder hole
Cod. 128005

B. Bocchetta Standard / Standard escutcheon

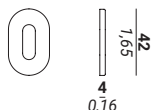

Foro chiave /
Key hole
Cod. 128001

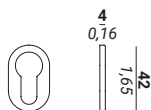

Foro cilindro /
Cylinder hole
Cod. 128004

C. Bocchetta Slim diametro 30 mm - 1,18 inch per foro chiave / Slim key hole escutcheon diameter 30 mm - 1,18 inch

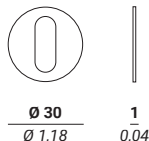

Da abbinare a rondella
diametro 30 mm -
1,18 inch (Cod. 128009)
To be matched with 30
mm - 1,18 inch diameter
washer (Cod. 128009)

Cod. 128010

D. Bocchetta Slim diametro 45 mm - 1,77 inch per foro chiave / Slim key hole escutcheon diameter 45 mm - 1,77 inch

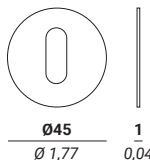

Da abbinare a rondella
diametro 45 mm - 1,77
inch (Cod. 128025)
To be matched with 45
mm - 1,77 inch diameter
washer (Cod. 128025)

Cod. 128026

E. Bocchetta Slim diametro 45 mm - 1,77 inch per foro cilindro / Slim cylinder hole escutcheon diameter 45 mm - 1,77 inch

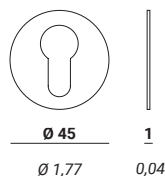

Da abbinare a rondella
diametro 45 mm - 1,77
inch (Cod. 128025)
To be matched with 45
mm - 1,77 inch diameter
washer (Cod. 128025)

Cod. 128027

F. Rondella diametro 30 mm - 1,77 inch per nottolino modello Pure, Wind e Atlanta / 30 mm - 1,77 inch diameter washer for privacy set model Pure, Wind and Atlanta



Cod. 128029

Bocchette e rondelle / Escutcheons and washers

$\frac{\text{mm}}{\text{inch}}$

G. Rondella diametro 24 mm / 0,94 inch washer

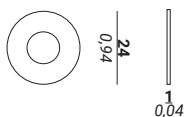

Per pannelli preforati con
diametro fino a 20 mm / 0,94 inch
For predrilled panels with a
diameter up to 20 mm / 0,94 inch



Disponibile nelle finiture come le maniglie
Available in the same handle finishes

Cod. 128008

H. Rondella diametro 30 mm / 1,18 inch washer

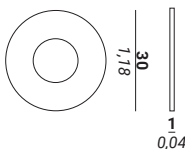

Per pannelli preforati con
diametro fino a 24 mm / 0,94 inch fuori asse
For predrilled panels with a
diameter up to 24 mm / 0,94 inch out of axis

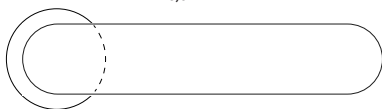

Disponibile nelle finiture come le maniglie
Available in the same handle finishes

Cod. 128009

I. Rondella diametro 45 mm / 1,77 inch washer

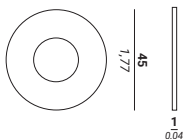

Per pannelli preforati con
diametro fino a 30 mm / 1,18 inch
For predrilled panels with a
diameter up to 30 mm / 1,18 inch

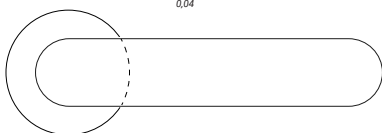

Disponibile nelle finiture come le maniglie
Available in the same handle finishes

Cod. 128025

Maniglie ad incasso per scorrevoli in legno / Inset handles for sliding wooden doors

Finiture / Finishes

cod. 14 Cromo Satinato / *Satin Chrome*
 cod. 39 Cromo Lucido / *Polished Chrome*
 cod. 49 Bianco Monviso / *Monviso White*
 cod.18 Nero Etna / *Etna Black*
 cod. 21 Bronzo Yester / *Yester Bronze*
 cod. 37 Ottonato Lucido / *Polished brass*

Maniglia ad incasso per scorrevole con nottolino e ditale
Inset thumb turn handle with recessed finger pull

Cod. 122015

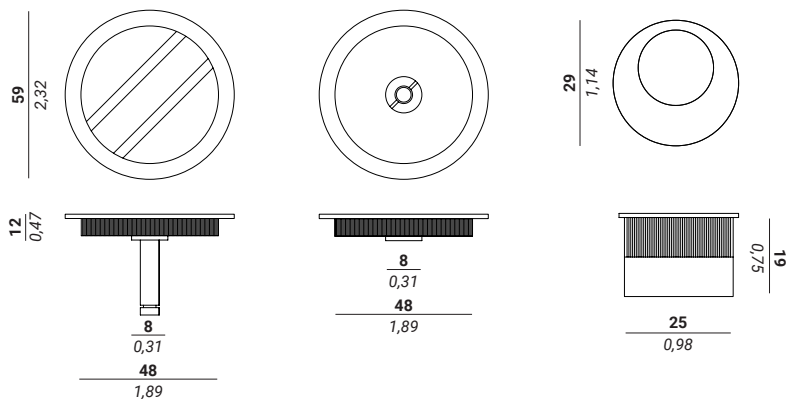

Maniglia ad incasso per scorrevole con nottolino
Inset thumb turn handle

Cod. 122013

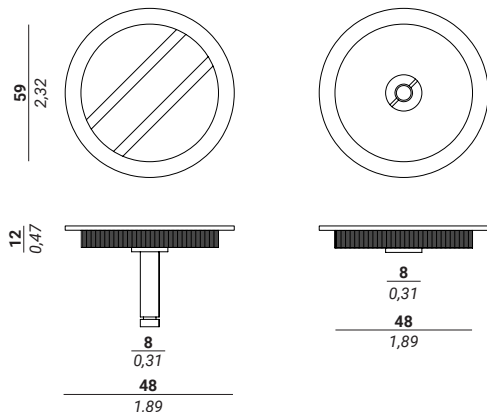

Maniglie ad incasso per scorrevoli in legno / Inset handles for sliding wooden doors

Finiture / Finishes

- cod. 14 Cromo Satinato / *Satin Chrome*
- cod. 39 Cromo Lucido / *Polished Chrome*
- cod. 49 Bianco Monviso / *Monviso White*
- cod.18 Nero Etna / *Etna Black*
- cod. 21 Bronzo Yester / *Yester Bronze*
- cod. 37 Ottonato Lucido / *Polished brass*

Maniglia ad incasso cieca

Inset handle

Cod. 122016

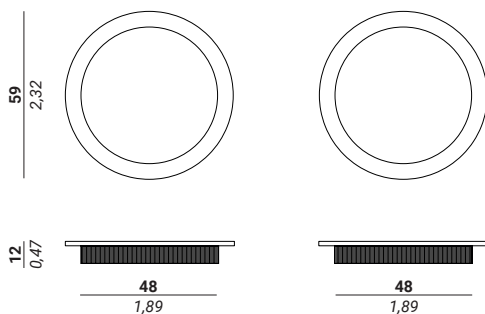

Maniglia ad incasso cieca Inset handle with recessed finger pull

Cod. 122017

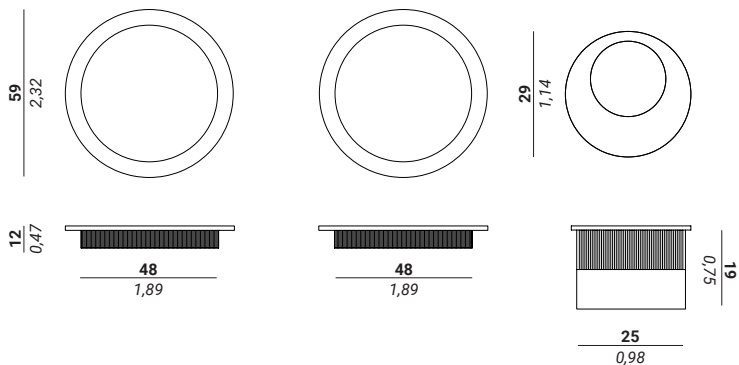

Serrature / Locks

Serrature magnetiche /
Magnetic locks (Cod. 180)

Serrature meccaniche /
Mechanical locks (Cod. 183)

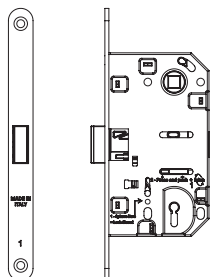

Foro chiave /
Keyhole

Cod. 004

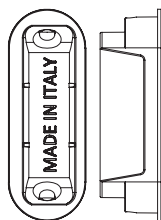

Incontro per serratura
magnetica / Striking
plate for magnetic lock
Cod. 181001

Incontro per serratura
meccanica / Striking
plate for mechanical lock

Cod. 184005

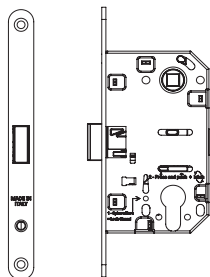

Foro cilindro /
Cylinder hole

Cod. 005

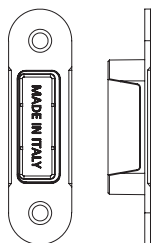

Incontro con piastrina
per serratura magnetica /
Striking plate with platelet
for mechanical lock
Cod. 181003

Incontro con piastrina per
serratura meccanica /
Striking plate with platelet
for mechanical lock

Cod. 184004

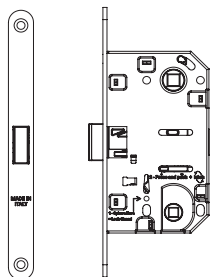

Foro nottolino /
Privacy set hole

Cod. 006

Finiture / Finishes

Cromo satinato / Satin Chrome

Cromo Lucido / Polished Chrome

Bianco Monviso / Monviso White

Nero Etna / Etna Black

Bronzo Yester / Yester Bronze

Materiale / Material

Abs / Abs

Metallo / Metal

Quadri per maniglie / Handles spindles

Le maniglie della collezione Nuda vengono fornite con un quadro con fissaggio a due grani per porte di spessore compreso tra i 40 e 60 mm / 1,57 e 2,36 inch.

Su richiesta è possibile fornire quadri adatti per i seguenti spessori:
30-50 mm / 1,18 - 1,97 inch
50-70 mm / 1,97 - 2,76 inch
60-80 mm / 2,36 - 3,15 inch

Per il mondo dell'industria, è possibile richiedere un quadro premontato di lunghezza desiderata con fissaggio a un solo grano.

Nuda handles come as standard with a spindle with 2 fixing grains for 40-60 mm / 1,57 - 2,36 inch thickness doors.

On demand, it is also possible to provide spindles for the following door panel thicknesses:

*30-50 mm / 1,18 - 1,97 inch
50-70 mm / 1,97 - 2,76 inch
60-80 mm / 2,36 - 3,15 inch*

For the industry sector, Nuda handles can be provided with preassembled spindles for a desired door panel thickness with a single fixing grain.

Quadri per nottolini / Privacy set spindles

I nottolini della collezione Nuda sono forniti con un quadro adattabile per spessore pannello porta compreso tra 40 - 55 mm / 1,57 - 2,17 inch.

Su richiesta disponibili anche per spessore pannello porta compreso tra 55 -70 mm / 2,17 - 2,76 inch.

Nuda privacy sets come as standard with a spindle suitable for door panels with a thickness of 40-55 mm / 1,57 - 2,17 inch

On demand, it is also possible to provide privacy set spindles for door panel with a thicknesses of 55 -70 mm / 2,17 - 2,76 inch.

Foratura porta / Door drilling

mm
inch

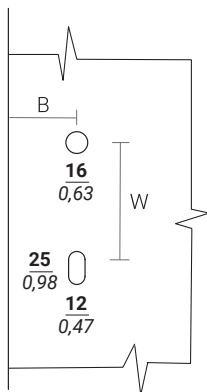
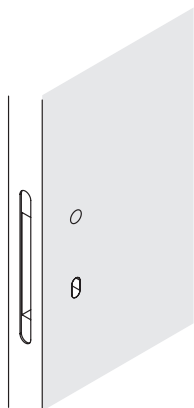

**Maniglia con bocchetta foro chiave standard e slim.
Set pomoli girevoli con bocchetta foro chiave standard o slim.**

***Handle with standard or slim key hole escutcheon.
Turnable knob set with standard or slim key hole escutcheon.***

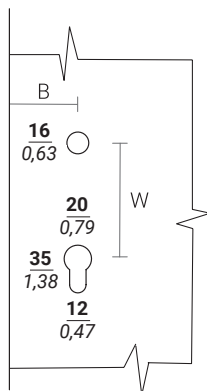
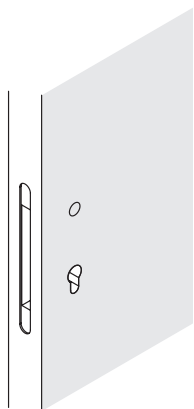

**Maniglia con bocchetta foro cilindro standard e slim.
Set pomoli girevoli con bocchetta foro cilindro standard o slim.**

***Handle with standard or slim cylinder hole escutcheon.
Turnable knob set with standard or slim cylinder hole escutcheon.***

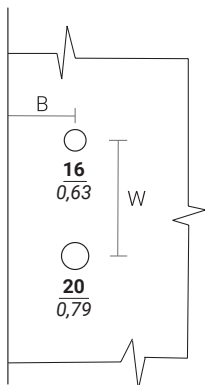
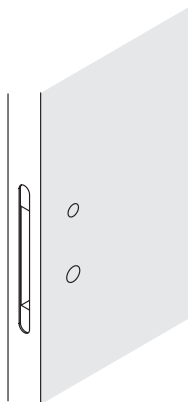

mm
inch

**Maniglia con nottolino
mod. Pure/Wind e Atlanta
Set pomoli girevoli con nottolino
mod. Pure/Wind e Atlanta.**

*Handle with privacy set
mod. Pure/Wind and Atlanta
Turnable knob set with privacy set
mod. Pure/Wind and Atlanta.*

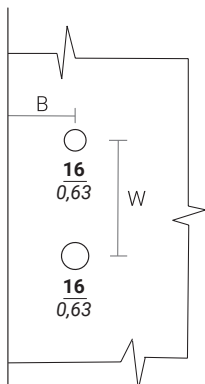
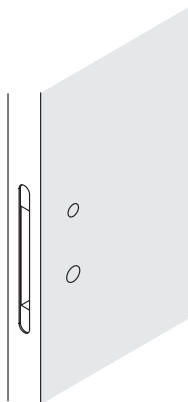

**Maniglia con nottolino
mod. Punto
Set pomoli girevoli con nottolino
mod. Punto.**

*Handle with privacy set
mod. Punto
Turnable knob set with privacy set
mod. Punto.*

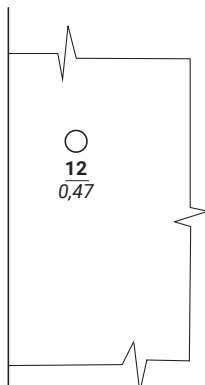
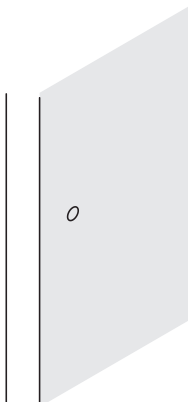

**Pomolo fisso singolo/
doppio**

*Fixed single/ double
knob set*

Ambienti

Environments

Il minimalismo di Nuda permette di valorizzare ogni ambiente di casa offrendo un tocco di design ricercato in grado di adattarsi ad ogni esigenza.

Nuda can enhance every home environment thanks to its minimalism which offers a refined design able to adapt to every need.



Maniglia mod. Pepe, finitura Cromo Satinato
Maniglia mod. Pepe, finish Satin Chrome

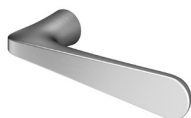



Maniglia mod. Pure, finitura Nero Etna
Maniglia mod. Pure, finish Etna Black





Maniglia mod. Lieve, finitura Cromo Satinato
Maniglia mod. Lieve, finitura Satin Chrome

Nottolino mod. Punto, finitura Cromo Satinato
Privacy set mod. Punto, finish Satin Chrome

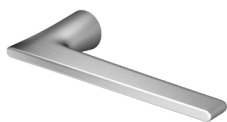



Maniglia mod. Baar, finitura Nero Etna
Maniglia mod. Baar, finish Etna black



Vetro

Glass



Yoyo

60



Tondo

61



Vulcano sliding

62



Cham sliding

63

Yoyo

Design Nuda R&D

Cod. 122009

**Finiture /
Finishes**

cod. 49
Bianco Monviso /
Monviso White

cod. 80
Grigio Milano /
Milan Grey

cod.18
Nero Etna /
Etna Black



**Fissaggio con vite
Fixing with a screw**

**Dimensioni /
Dimensions**

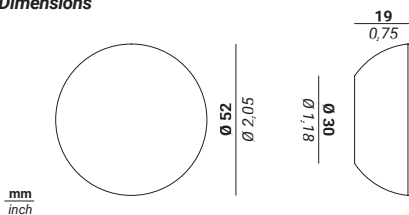

Tondo

Design Nuda R&D

Cod. 122010

**Finiture /
Finishes**

cod. 49
Bianco Monviso /
Monviso White

cod. 80
Grigio Milano /
Milan Grey

cod.18
Nero Etna /
Etna Black



**Fissaggio con biadesivo VHB
Fixing with VHB adhesive**

**Dimensioni /
Dimensions**

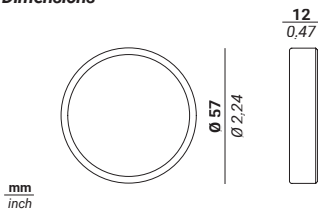

Vulcano sliding

Design Nuda R&D

Cod. 122011

**Finiture /
Finishes**

cod. 49
Bianco Monviso /
Monviso White

cod. 80
Grigio Milano /
Milan Grey

cod.18
Nero Etna /
Etna Black



**Fissaggio con biadesivo VHB
Fixing with VHB adhesive**

**Dimensioni /
Dimensions**

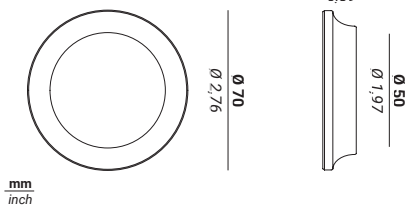

Cham sliding

Design Nuda R&D

Cod. 122012

**Finiture /
Finishes**

cod. 49
Bianco Monviso /
Monviso White

cod. 80
Grigio Milano /
Milan Grey

cod.18
Nero Etna /
Etna Black



**Fissaggio con biadesivo VHB
Fixing with VHB adhesive**

**Dimensioni /
Dimensions**

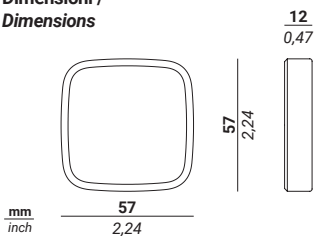

Piastre porte vetro

Glass door plates



Total Glass

66

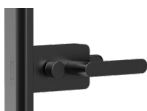

Glass Frame

68



Vulcano Lock

70

Total Glass

Le maniglie Nuda possono essere applicate su porte in vetro senza battuta grazie all'apposita piastra Total Glass. Serratura magnetica inclusa nel kit.

Nuda handles can also be installed on glass doors without strike thanks to the specific Total Glass plate. Magnetic lock included in the kit.

Spessore vetro 8 mm – 0,31 inch
Glass thickness 8 mm – 0,31 inch

Cod. 13030

Materiale /
Material

Ottone/
Brass

Finiture /
Finishes

cod. 14
Cromo Satinato /
Satin Chrome

cod. 49
Bianco Monviso /
Monviso White

cod. 18
Nero Etna /
Etna Black



Piastra Total Glass versione con maniglia e nottolino Punto / Total Glass plate with handle and Punto privacy set

Disponibile nelle seguenti versioni /
Available in the following versions

Cod. 01
Solo maniglia /
Only handle

Cod. 02
Maniglia e nottolino Punto /
Handle and Punto privacy set

Cod. 03
Maniglia e foro cilindro /
Handle and cylinder hole



Contropiastra / Counterplate
Cod. 128030

Dimensioni /
Dimensions

$\frac{\text{mm}}{\text{inch}}$

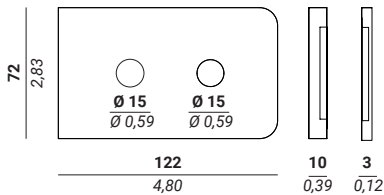

Dimensioni contropiastra /
Dimensions counterplate

$\frac{\text{mm}}{\text{inch}}$

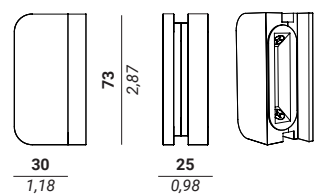

Glass Frame

Per porte in vetro con profilo in alluminio con o senza battuta è possibile realizzare su misura la piastra Glass Frame. Serratura magnetica inclusa nel kit.

For glass doors with aluminium profile (with or without strike) it is possible to realize Glass Frame A plate on demand. Magnetic lock included in the kit.

Spessore vetro 6 mm – 0,24 inch
Glass thickness 6 mm – 0,24 inch

Cod. 13040

**Materiale /
Material**

Ottone/
Brass

**Finiture /
Finishes**

cod. 14
Cromo Satinato /
Satin Chrome

cod. 49
Bianco Monviso /
Monviso White

cod. 18
Nero Etna /
Etna Black



**Piastra Glass Frame con battuta.
Versione maniglia con nottolino Punto
Glass Frame plate with strike.
Handle and Punto privacy set version**

**Disponibile nelle seguenti versioni /
Available in the following versions**

Cod. 01
Solo maniglia /
Only handle

Cod. 02
Maniglia e nottolino Punto /
Handle and Punto privacy set

Cod. 03
Maniglia e foro cilindro /
Handle and cylinder hole

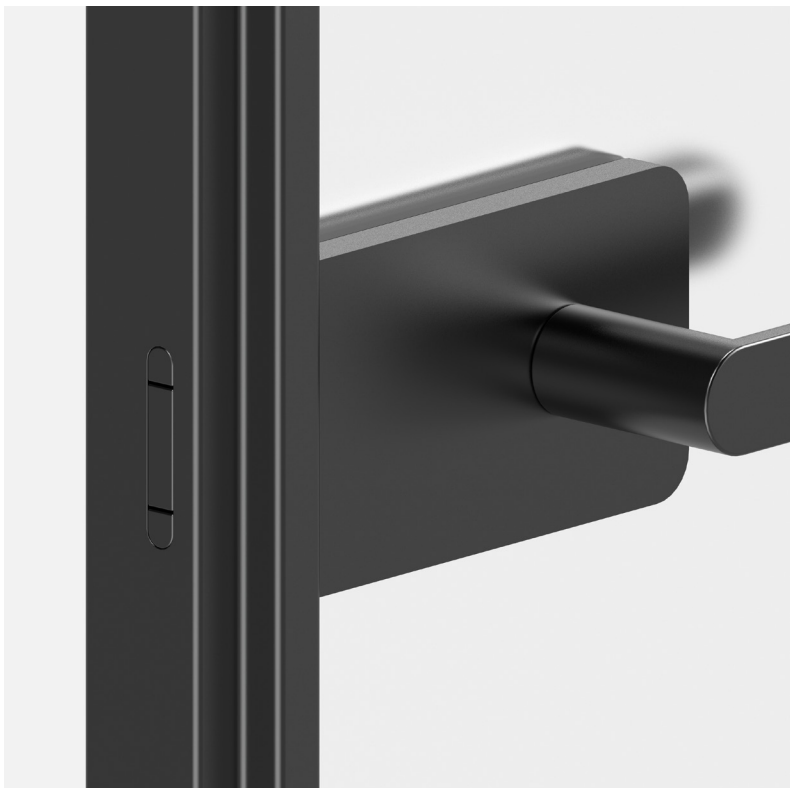

Piastra Glass Frame con battuta. Versione solo maniglia
Glass Frame plate with strike. Version with only handle

Dimensioni /
Dimensions

mm
inch

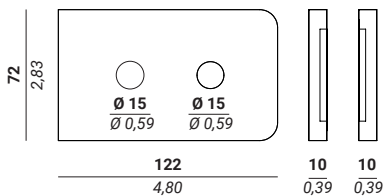

Vulcano Lock

Piastra per vetro con serratura e sistema push & pull per trascinamento dell'anta. Utilizzabile su porte scorrevoli in vetro con o senza profilo in alluminio.

Glass plate with lock and push & pull system to easily slide the glass door.

For glass sliding doors with or without aluminium profile.

Spessore vetro versione con profilo alluminio

6 mm – 0,24 inch

Glass thickness with aluminium profile

6 mm – 0,24 inch

Spessore vetro senza profilo alluminio

8 mm – 0,31 inch

Glass thickness without aluminium profile

8 mm – 0,31 inch



**Materiale /
Material**

**Alluminio /
Aluminium**

**Piastra Vulcano Lock
Versione senza profilo alluminio
Vulcano Lock Plate
Version without aluminium profile**

**Finiture /
Finishes**

**cod. 80
Grigio Milano /
Milan Grey**

**cod. 49
Bianco Monviso /
Monviso White**

**cod. 18
Nero Etna /
Etna Black**

**Disponibile nelle seguenti versioni /
Available in the following versions**

**Cod. 122018
Porte in vetro senza profilo in alluminio /
Glass doors without aluminium profile**

**Porte in vetro con profilo in alluminio su richiesta /
Glass doors with aluminium profile on request**



Contropiastra / Counterplate
Cod. 122019

Dimensioni piastra /
Plate dimensions

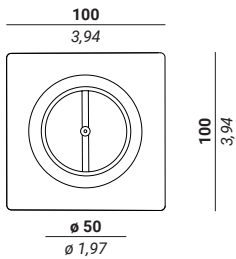

Dimensioni contropiastra /
Counterplate dimensions

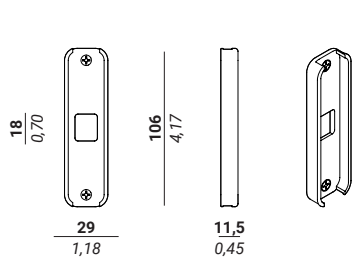

Finiture



Bronzo Yester
Yester Bronze



Grigio Milano
Milan Grey

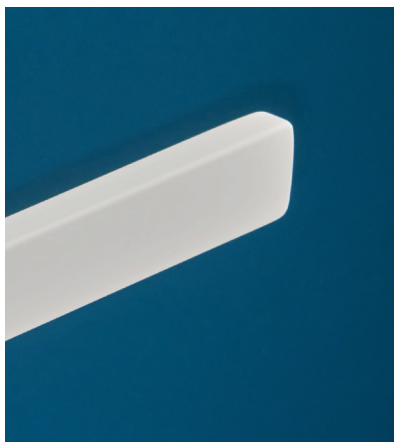

Bianco Monviso
Monviso White

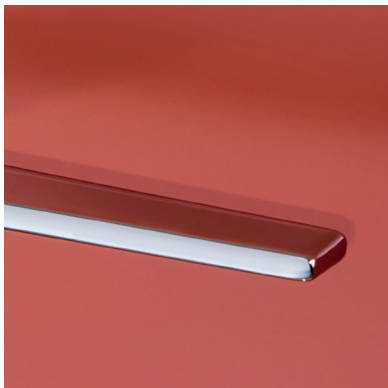

Cromo Lucido
Polished Chrome



Oro 24kt
Gold 24kt

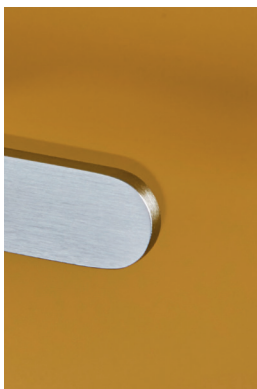

Cromo Satinato
Satin Chrome

Nero Etna
Etna Black



Finishes

Cod.14
Cromo Satinato
Satin Chrome

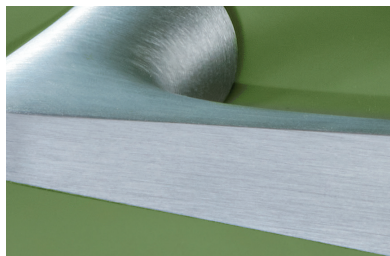

Cod.39
Cromo Lucido
Polished Chrome



Cod.18
Nero Etna
Etna Black

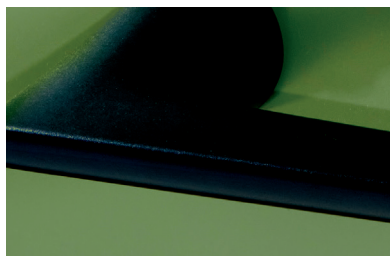

Finiture speciali su richiesta
Special finishes on demand

Cod.21
Bronzo Yester
Yester Bronze



Cod.49
Bianco Monviso
Monviso White



Cod.80
Grigio Milano
Milan Grey



STOPPINO

**Il modo più facile di
fermare la porta**



**The easiest way to
stop the door**

Stoppino Open

Stoppino Open è un fermaporte magnetico a pavimento estremamente minimalista sviluppato per porte da interno. Il suo utilizzo evita che la porta sbatta a causa di improvvisi colpi di vento o che possa urtare pareti o mobilio in prossimità di quest'ultima. Stoppino Open si compone di tre elementi: un corpo che viene inserito nel telaio della porta e una base con magnete per il pavimento. Stoppino Open è disponibile in due versioni: il modello 1 si caratterizza per una base dal limitato impatto visivo mentre il modello 2 ha una base con un design peculiare disponibile in diverse finiture. Entrambi le basi possono essere applicate a pavimento tramite biadesivo o con una vite e sono calpestabili. L'applicazione di Stoppino Open con biadesivo è ideale per ambienti con riscaldamento a pavimento o dove non è possibile effettuare fori. Il biadesivo è testato per resistere a situazioni con elevata umidità o temperatura.

Stoppino Open is a concealed magnetic door-stopper developed for interior doors. It prevents the door from opening too far and damaging nearby wall or furniture or slamming because of the wind. Stoppino Open has three main parts: the body to be fixed in the door inner frame and a base with a magnet for the floor. Stoppino Open is available in two versions: Model 1 has a small base for a low visual impact whereas model 2 has a specific design base available in different finishes. Both bases can be fixed to the floor with self-adhesive or with a screw and they are both walkable. The application of Stoppino Open with self-adhesive fixing is suitable for floor heating systems or where it is not possible to drill the floor. The self-adhesive is tested for environments with high humidity or temperature.

Stoppino Open è un sistema meccanico con applicazione magnetica di fermo per porte che permette di bloccare la porta in posizione di apertura.

***Stoppino Open is a mechanical door-stopper with magnets.
It allows to stop the door in the open position.***

Calpestabile

**Fissaggio base a pavimento
con biadesivo o piccola vite**

Nessun foro invasivo a pavimento

Prodotto in Italia

Walkable

**The base can be fixed to the floor
with adhesive or a small screw**

No invasive holes in the floor

Made in Italy

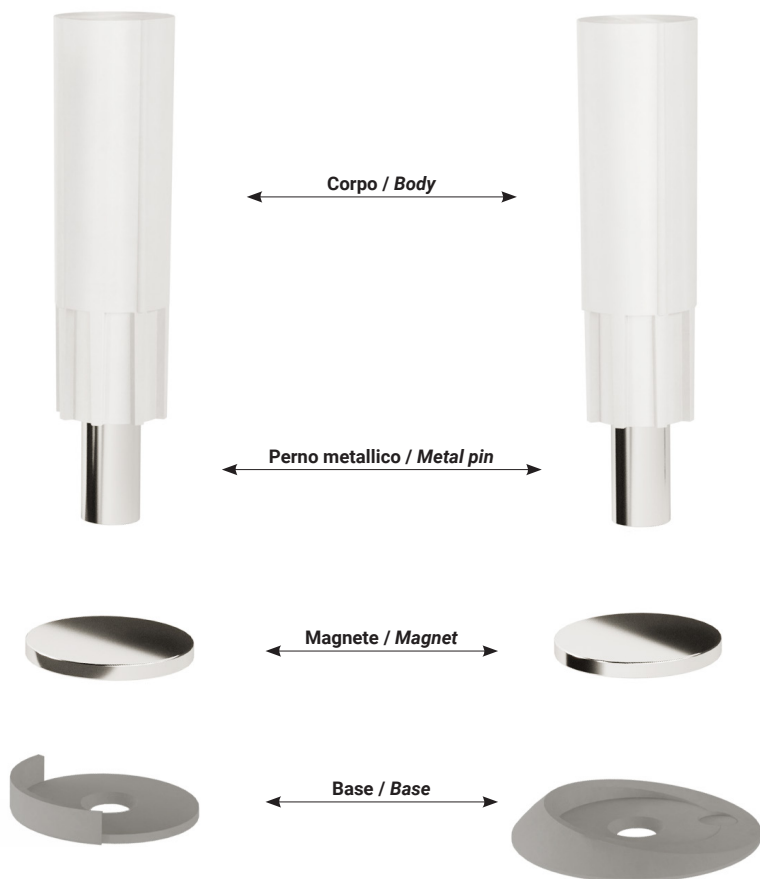

Base applicabile a pavimento con biadesivo o con vite. Si consiglia l'applicazione del corpo di Stoppino Open nel telaio della porta per un corretto funzionamento.

Floor mounted base with self-adhesive fixing or with a screw. It is highly recommended to install Stoppino Open body in the door wooden frame to ensure a proper functioning.

- Distanza min. (porta-pavimento)
5 mm / 0,20 inch
- Distanza max. (porta-pavimento)
14 mm / 0,55 inch

- *Minimum gap (door- floor)*
5 mm / 0,20 inch
- *Maximum gap (door-floor)*
14 mm / 0,55 inch

Stoppino Open Mod. 1

Cod. 160901



Finitura magnete : Cromo Lucido
Magnet finish : Polished Chrome

Finitura base : Zincato Bianco
Base finish : White Zync

Fermaporta magnetico interno

Internal magnetic door stopper

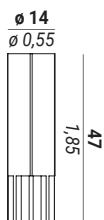
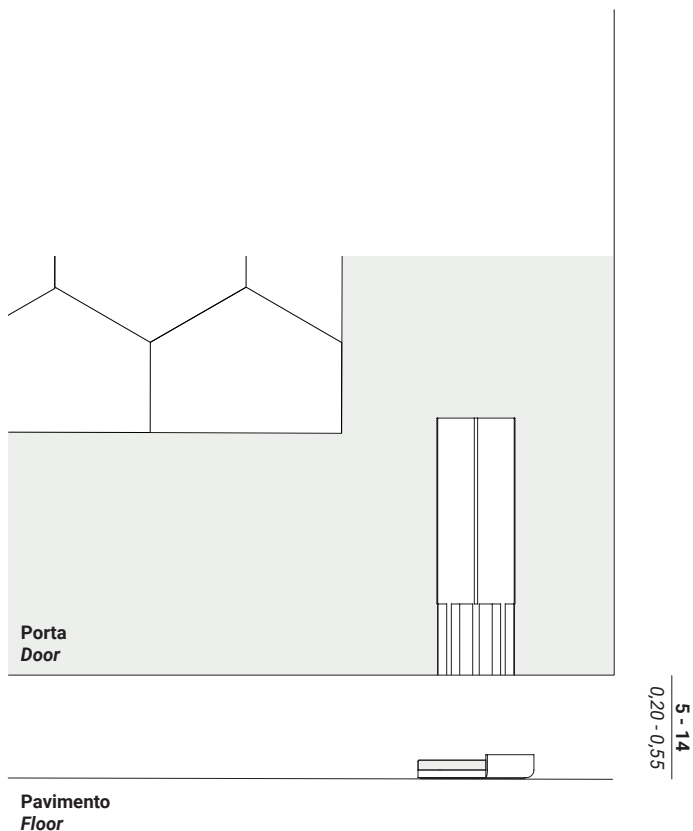

mm
inch

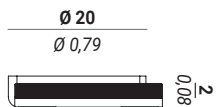
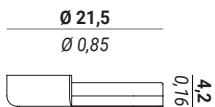

Stoppino Open Mod. 2

Cod. 160902



Finitura magnete : Cromo Lucido
Magnet finish : Polished Chrome

Finiture base
Base finishes



cod. 18
Nero
Black



cod. 49
Bianco
White



cod. 14
Grigio Opaco
Matt Grey



cod. 37
Ottonato Lucido
Polished Brass

Fermaporta magnetico interno

Internal magnetic door stopper

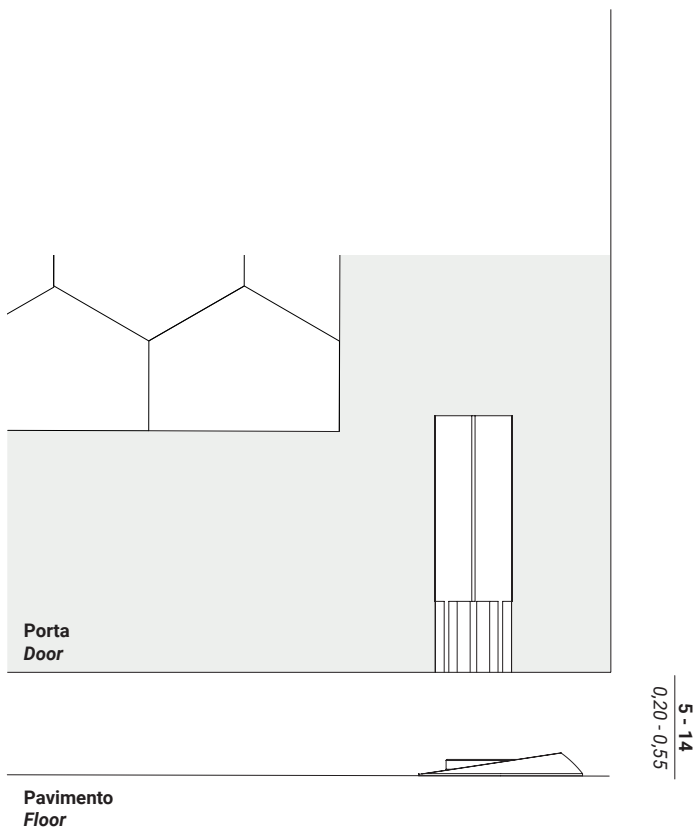

ø 14
ø 0,55

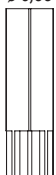

Disponibile versione con base altezza 5 mm - 0,20 inch. /
Version with 5 mm - 0,20 inch high base available

mm
inch

ø 30
ø 0,85

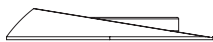

ø 20
ø 0,79



Stoppino X

Stoppino X è un fermaporte magnetico esterno da applicare direttamente sul pannello porta tramite biadesivo o con viti nascoste. Semplicità e rapidità di montaggio direttamente sulla porta già installata. Stoppino X ha una base dal design calpestabile e si applica a pavimento tramite biadesivo o con una vite.

Stoppino X is an external magnetic door stopper to be applied directly on the door panel with adhesive or with hidden screws. Simple and quick fixing on the door already installed. Stoppino X has a specific design walkable base that can be fixed to the floor with self-adhesive or with a screw.

Stoppino X è un fermaporte magnetico esterno da applicare direttamente sul pannello porta tramite biadesivo o con viti nascoste.

Stoppino X is an external magnetic door stopper to be applied directly on the door panel with adhesive or with hidden screws.

Calpestabile

**Fissaggio base a pavimento
con biadesivo o piccola vite**

Nessun foro invasivo a pavimento

**Corpo montabile direttamente sulla
porta con biadesivo o viti nascoste**

Prodotto in Italia

Walkable

**The base can be fixed to the floor
with adhesive or a small screw**

No invasive holes in the floor

**The body can be installed directly on the
door panel with adhesive or with
concealed screws**

Made in Italy

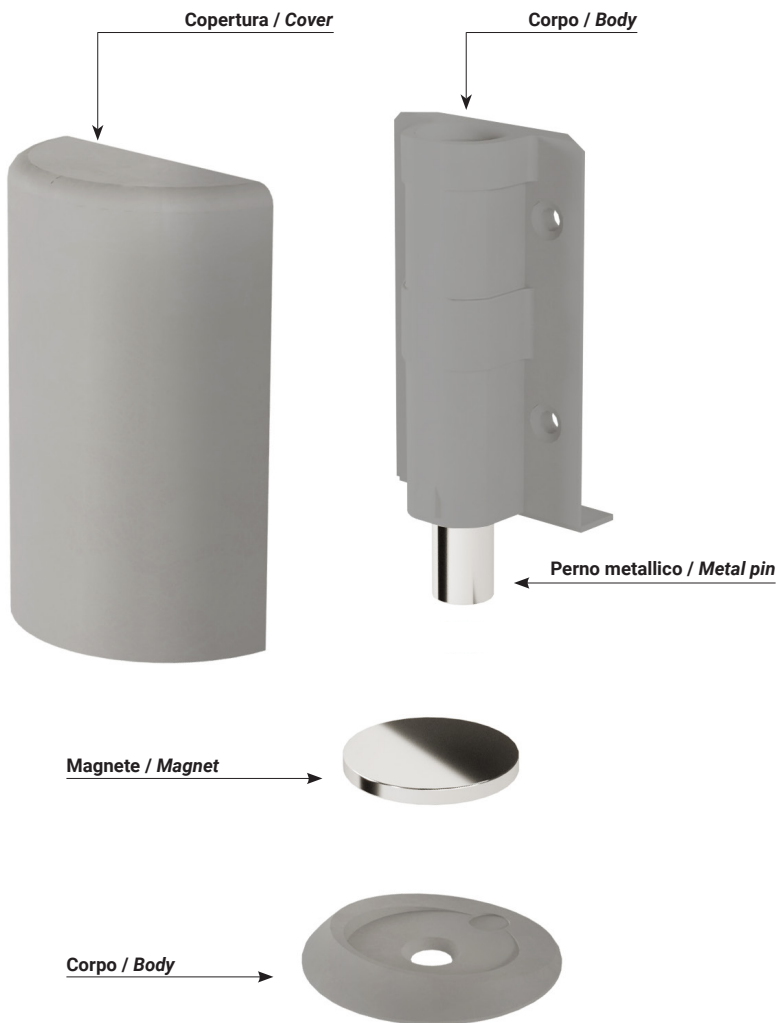

Stoppino X

Cod. 160905



Finiture magnete : Cromo Lucido
Magnet finishes : Polished Chrome

Finiture base e corpo
Base and body finishes

**Fissabile a pannello porta con
biadesivo o con viti nascoste/**
*It can be applied to the door
panel with adhesive or with
concealed screws*



cod. 18
Nero
Black



cod. 49
Bianco
White



cod. 14
Grigio Opaco
Matt Grey

Fermaporta magnetico esterno

External magnetic door stopper

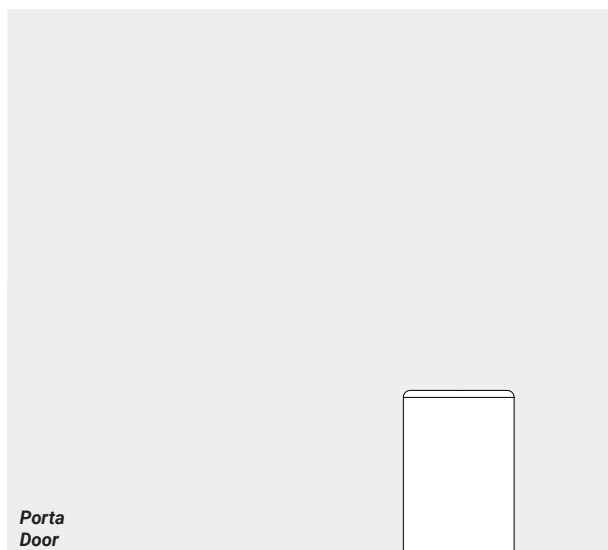

5 - 14
0,20 - 0,55

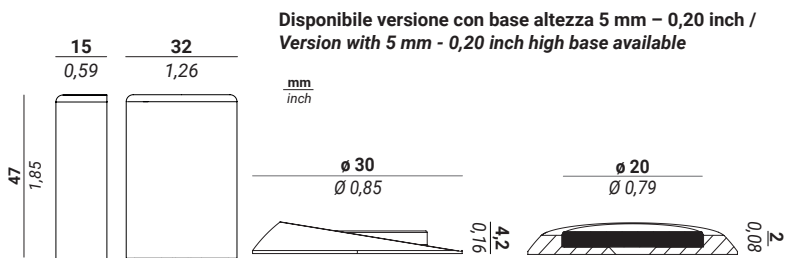

Stoppino Close

Stoppino Close è un sistema di chiusura per porte senza l'utilizzo di tradizionali serrature. Grazie al sistema con due magneti è possibile tenere l'anta in posizione di chiusura in qualsiasi situazione. I magneti permettono inoltre di eliminare qualsiasi rumore avvicinando o allontanando l'anta. L'installazione è altrettanto semplice ed immediata grazie agli scodellini che permettono di mantenere in posizione corretta i magneti e agendo su una vite di regolarne l'attrazione. Stoppino Close scompare completamente alla vista quando la porta viene chiusa. Per una soluzione ancor più minimalista è possibile applicare i magneti all'estremità superiore della porta, ottenendo così una pulizia completa dello stipite e del profilo della porta, eliminando invasive serrature. Stoppino Close è utilizzabile su ante in legno e su cornici d'alluminio.

Stoppino Close is a closing system for doors without traditional locks. Thanks to a system with two magnets, it is possible to keep the door shut in any situation. Moreover, there is no noise when opening and closing the door. Installation is quick and easy since the housing cups provided set automatically magnets in the correct position and with a screw you can adjust their attraction force. Stoppino Close is completely concealed when the door is closed. Magnets can also be applied on the top of the door for an even more minimalistic solution so that the frame and the side of the door will be completely clean with no visible hardware. Stoppino Close can be applied on wooden and aluminium frame doors.

**Stoppino Close ferma la porta in posizione di chiusura.
E' un sistema di chiusura magnetico per porte
sprovviste di serratura.**

*Stoppino Close keeps the door shut without a lock.
Stoppino Close is a magnetic closing system for doors
without a lock.*

Invisibile sulla porta

Totalmente silenzioso

Regolabile

Brevettato

Prodotto in Italia

Concealed on the door

Completely silent

Adjustable

Patented

Made in Italy

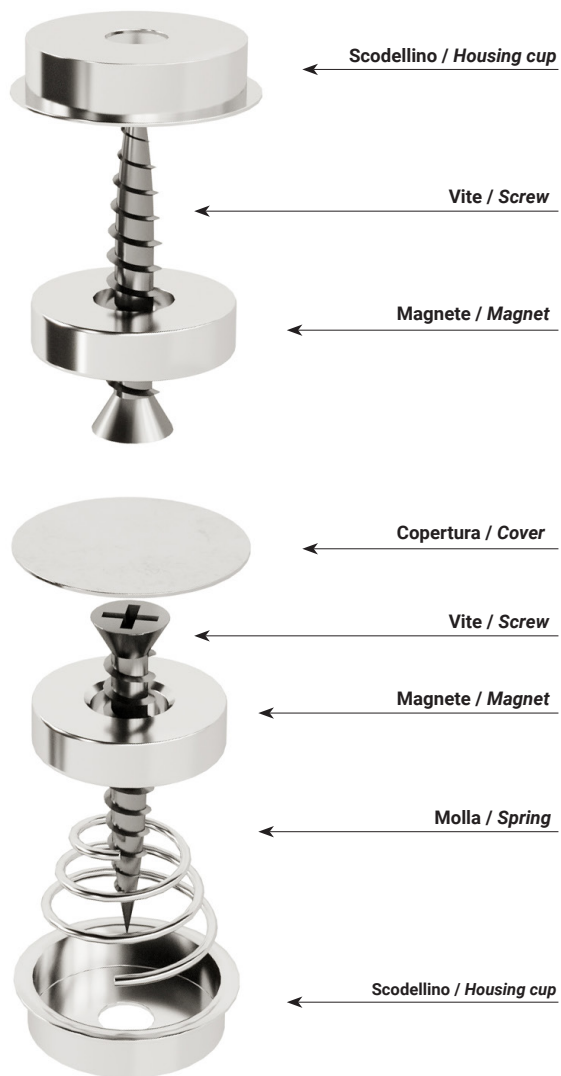

Stoppino Close

Cod. 160905



Per garantire una corretta attrazione:

- Mantenere una distanza minima di 1 mm / 0,04 inch tra i magneti
- Installare il magnete nella porta e nel telaio disassati di circa 10 mm / 0,39 inch
- Per agire sulla forza di attrazione dei magneti, avvitare o svitare la vite

Include una cover coprivite in finitura cromo satinato

To guarantee a correct attraction:

- Keep a minimum distance of 1 mm / 0,04 inch between magnets
- Install the magnet in the door and the one the frame about 10 mm / 0,39 inch off-set
- To adjust the attraction force of the magnets, screw or unscrew the screw

One cover plate in satin chrome finish is included

Installazione standard Standard installation

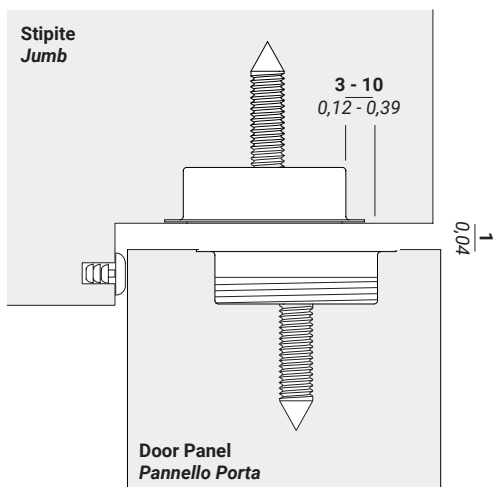

Installazione a scomparsa Concealed installation

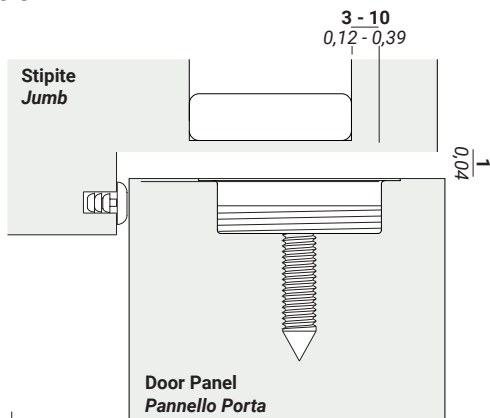

mm
inch

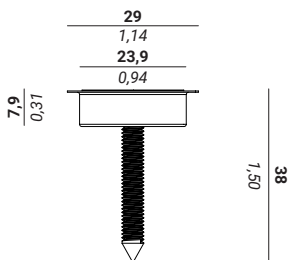

Finiture / Finishes

cod. 59 Acciaio Satinato / Satin Steel
cod. 49 Bianco Monviso / Monviso White
cod. 18 Nero Etna / Etna Black

Profili decorativi

Decorative profiles

Profili decorativi con alluminio in superficie in diverse finiture e molteplici sezioni. L'estrema flessibilità permette di adattarsi alle più diverse forme di applicazione offrendo un tocco elegante e raffinato.



Decorative profiles with a metallic surface in different finishes and multiple cuts. The high flexibility guarantees the adaptation on several kinds of application, adding a unique and refined touch.

mm
inch

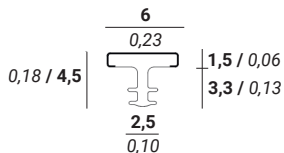
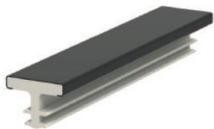

Cod. 150002

Disponibile a stock finitura cod. 39, 07, 02

Available in stock finishes cod. 39, 07, 02

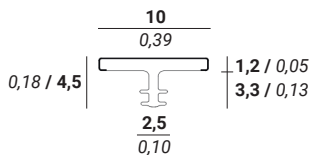
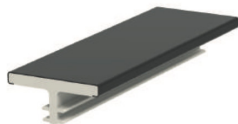

Cod 150008

Disponibile a stock finitura cod. 39, 07, 02

Available in stock finishes cod. 39, 07, 02

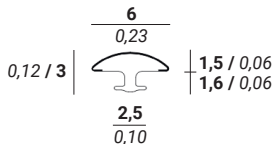

Cod. 150012

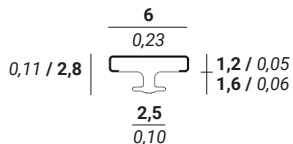
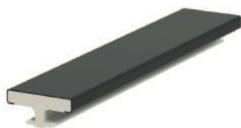

Cod. 150001



Cod.150004

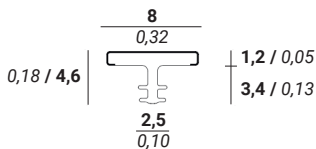
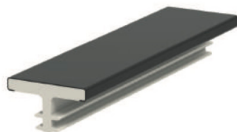

Cod. 150005

mm
inch

Cod. 150006

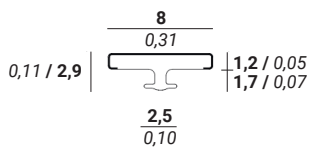
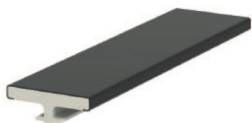

Cod. 150007

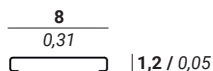
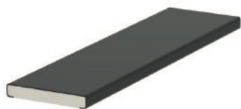

Cod.150011

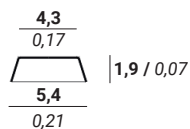
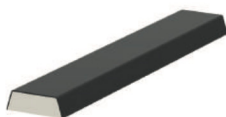

Cod. 150009

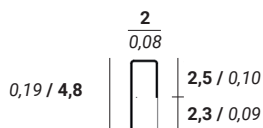

Cod. 150010

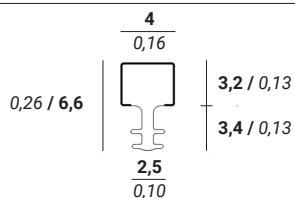
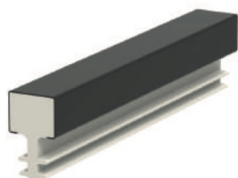

mm
inch

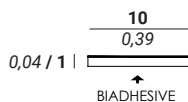
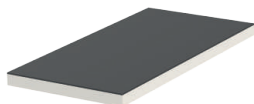

Cod. 150025

Disponibile a stock finitura 69 e 38 nelle texture cod. 00, 04, 05

Available in stock finishes cod. 39,07,02 in textures cod. 00, 04, 05

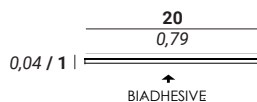
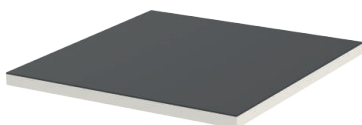

Cod. 150030

Disponibile a stock finitura 69 e 38 nelle texture cod. 00, 04, 05

Available in stock finishes cod. 39,07,02 in textures cod. 00, 04, 05

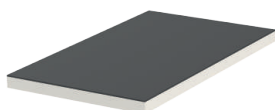

Cod. 150026

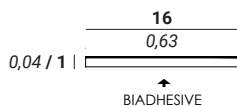
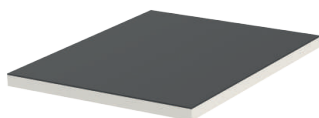

Cod. 150028

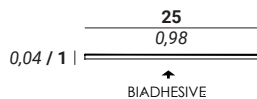
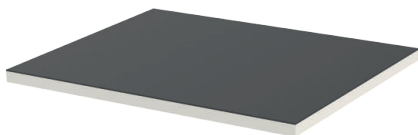

Cod. 150031

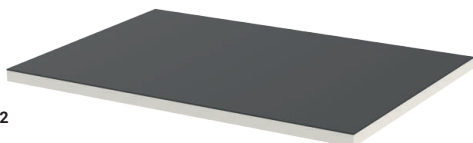

Cod. 150032

Finiture / Finishes

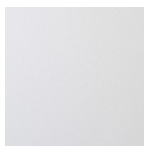

Cod. 39
Cromo Lucido
Polished Chrome

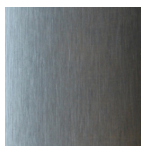

Cod. 69
Inox Spazzolato
Brushed Inox

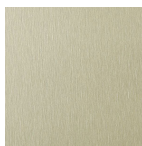

Cod. 02
Oro Opaco
Matt Gold



Cod. 07
Alluminio Spazzolato
Brushed Aluminium

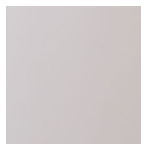

Cod. 67
Alluminio naturale
Natural aluminium

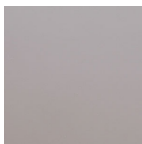

Cod. 60
Acciaio Inox
Inox Steel

Textures / Textures



Cod. 00
No Texture

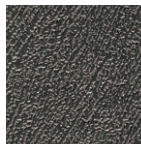

Cod. 01

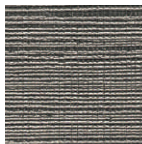

Cod. 02

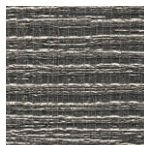

Cod. 03

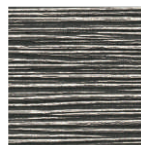

Cod. 04

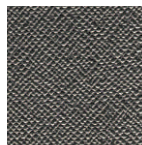

Cod. 05

**Espositori
commerciali**

**Commercial
displays**

**Una gamma di espositori per presentare al meglio i prodotti
Verum Italy in showroom e spazi espositivi.
Soluzioni personalizzabili a pavimento o a banco
per adattarsi a tutte le necessità commerciali.**

**A range of displays to present at best Verum Italy products in
every showroom or exhibition space. Floor or counter solutions
that can be personalized to adapt to all commercial needs.**

Espositore Nuda pavimento / Nuda Floor Display

Cod. 160996

Espositore da banco con 6 modelli a scelta di
maniglie o pomoli
*Counter display with 6 models of handles or knobs
of choice*

mm
inch

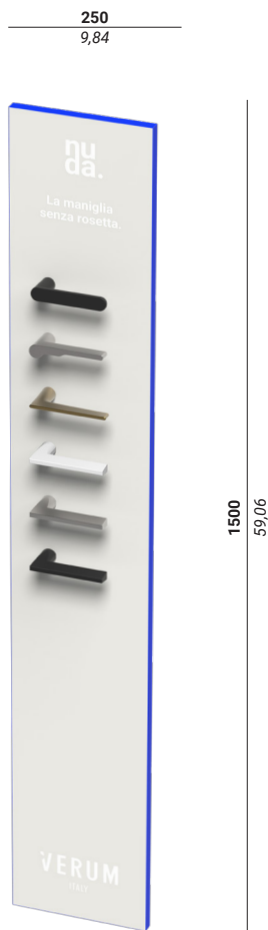

Espositore Nuda banco / Nuda Counter Display

Cod. 160997

Espositore da banco con 3 modelli a scelta di
maniglie o pomoli
*Counter display with 3 models of handles or
knobs of choice*

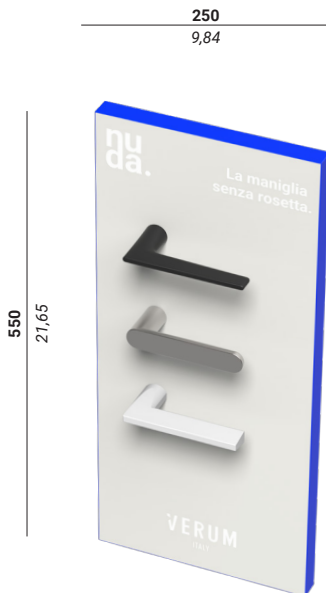

Condizioni generali di vendita

MODELLI, DIMENSIONI, PESI

Verum Italy si riserva, in qualunque momento e senza preavviso, di modificare e/o sopprimere gli articoli del presente catalogo. Dati, misure o schemi su questo catalogo hanno solamente carattere informativo, non sono vincolanti e possono essere soggetti a variazioni.

ORDINI

Verranno accettati solo ordini per iscritto; ordini pervenuti telefonicamente o verbalmente non saranno ritenuti validi. Con la trasmissione dell'ordine il cliente accetta tutte le condizioni elencate di seguito. L'ordine è vincolante per il cliente, mentre impegna Verum Italy solo dopo espressa accettazione. Non possono essere effettuati annullamenti senza l'accordo scritto di Verum Italy, che si riserva comunque di applicare oneri e spese che ne derivino.

TERMINI DI CONSEGNA

I tempi di consegna dell'ordine decorrono dalla data della nostra conferma salvo diversa stipulazione e non potranno in nessun luogo dare luogo ad indennizzo/risarcimento da parte di Verum Italy. I termini di consegna indicati nell'ordine sono da intendersi puramente indicativi e non vincolanti per Verum Italy, che non sarà responsabile di eventuali ritardi. In particolare non è responsabile per ritardata o omessa consegna, totale o parziale, imputabile a cause di forza maggiore, o ad eventi che siano fuori dal suo controllo, quali, in via esemplificativa, scioperi aziendali e di trasporto, mancanza di energia elettrica, mancata o ritardata ricezione di materie prime, ecc. Verum Italy si riserva il diritto di evadere l'ordine anche con spedizioni parziali.

DATI IDENTIFICATIVI DEL CLIENTE

Il cliente è responsabile della comunicazione dei propri dati fiscali forniti in base alla legislazione vigente (Ditta, Ragione sociale, Sede, Partita IVA). I dati del cliente saranno custoditi ed elaborati per adempimenti degli obblighi di Legge. Ogni altro utilizzo dovrà essere espressamente autorizzato dal cliente.

SPEDIZIONI

La merce viaggia a rischio e pericolo del committente franco stabilimento Verum Italy che declina comunque ogni responsabilità per ritardi o rotture verificatesi durante il trasporto. Spetta al committente verificare la merce in arrivo e contestare eventuali danni direttamente al trasportatore, anche se questi è stato scelto da Verum Italy, entro 8 giorni dal ricevimento della stessa mediante raccomandata A.R. Si accettano eventuali reclami sulla quantità di pezzi ricevuta al massimo entro 8 giorni dalla data di consegna.

PAGAMENTO

I pagamenti devono essere effettuati direttamente a Verum Italy nei termini pattuiti. Trascorsi i termini Verum Italy provvederà senza alcun preavviso all'addebito degli interessi di mora stabiliti per Legge, che decorreranno dal giorno immediatamente successivo alla scadenza del debito. Il mancato rispetto dei pagamenti pattuiti, comunicati per iscritto nelle conferme d'ordine, può comportare, a discrezione dell'azienda, il blocco degli ordini in corso fino a pagamento avvenuto e la sospensione delle ulteriori forniture anche se già accettate. I pagamenti dei prodotti già consegnati non saranno subordinati al completamento dell'ordine. Nessun pagamento potrà essere differito nel caso di contestazioni salvo accordi diversi. Fino al momento in cui Verum Italy non abbia ricevuto il pagamento del valore complessivo dei prodotti, gli stessi rimarranno di esclusiva proprietà di Verum Italy.

RESPONSABILITÀ

Non si accettano merci di ritorno se non rese in Porto Franco e preventivamente autorizzate da Verum Italy. Solo il materiale riscontrato difettoso da Verum Italy sarà sostituito gratuitamente senza nessun altro indennizzo per danni, spese o riparazioni. Verum Italy non si assume alcuna responsabilità e alcuna garanzia è prevista per difetti e danni derivanti da installazione impropria o cattivo uso. È vietato agli acquirenti effettuare qualsiasi lavorazione che modifichi le caratteristiche originarie dei prodotti Verum Italy.

CONTROVERSIE

Le forniture sono soggette alla Legge italiana. Per qualunque controversia è riconosciuta la sola ed esclusiva competenza del Foro di Milano, Italia.

TERMINI DI GARANZIA

Si certifica che i prodotti Verum Italy sono interamente prodotti in Italia nelle nostre Aziende, salvo dove espressamente indicato. Ogni articolo, stampato o fuso e lavorato a mano è unico ed irripetibile e le piccole differenze cromatiche, che posso- no riscontrarsi, rappresentano la garanzia più certa dell'artigianalità del prodotto. Eventuali imperfezioni e/o differenze nella forma, nelle finiture e nei materiali sono da attribuire alla tecnologia e/o alle operazioni manuali necessarie alla lavorazione del prodotto. L'osservanza delle istruzioni di montaggio e/o una non cura nell'utilizzo dei prodotti Verum Italy possono causare il mal funzionamento per i quali si declina ogni responsabilità.

CONSIGLI PER LA PULIZIA, LA CURA E LA MANUTENZIONE DEL PRODOTTO

Si consiglia di pulire i prodotti Verum Italy utilizzando solamente un panno asciutto o leggermente inumidito con acqua. Non utilizzare assolutamente alcun detergente chimico per non alterare l'efficacia del trattamento superficiale.

General sales terms and conditions

MODELS, DIMENSIONS AND WEIGHTS

Verum Italy reserves the right, at any time, to change and/or to cancel the items of this catalogue. Information, size or drawings in this catalogue are only for information and are not binding.

ORDERS

Orders are accepted only in written form; orders or modifications communicated verbally and/or by phone will not be valid. Customers accept and are aware that their order is subject to the following general sale terms and conditions. Verum Italy is not legally bound by an order until we have confirmed it in written form but the Customer is bound when he/she accepts it. No cancellation of the order is valid without written agreement from Verum Italy Srl, which reserves the right to apply charges.

DELIVERY TERMS

Delivery time starts from the order confirmation date, unless otherwise agreed, Verum Italy Srl will not recognize any indemnity or compensation. The order delivery terms are purely indicative and not binding for Verum Italy Srl, which is not responsible for any delay. Verum Italy is not liable for delayed or skipped delivery in its totality or partially, due to acts of God or other event out of its control, like for example labour or freight strikes, lack of electric energy, missed or delayed raw material receipt and so on. Verum Italy reserves the right to dispatch orders even with partial shipment.

CUSTOMER INFORMATION

The Customer is responsible for all the identification information data requested by the legislation in effect (Company name, legal name, Address, VAT, etc.). All Customer's data will be kept and used in full compliance with the Italian Law. All other use must be specifically allowed by the Customer.

DELIVERIES

Ordered goods will be at the Customer's risk from the moment of delivery so Verum Italy declines any responsibility for delays or damage caused during the shipment. The Customer is responsible for checking the delivered goods and reporting possible damage to the forwarder, even if chosen by Verum Italy, within 8 (eight) days from receipt by certified mail. The Customer is also responsible for checking the quantity of the delivered goods; claims about quantity will only be accepted within 8 (eight) days from receipt.

PAYMENTS

Payments shall be made directly to Verum Italy Srl in the manner and at the time agreed by the parties. In the event of failure to make the payment at the due date, the Customer will, with effect from the invoice date, be charged of interests and penalties. If the Customer is in default, Verum Italy shall have the right to defer shipment or any future order intake or delivery until such default is remedied or said credit reestablished to our satisfaction. No claim shall enable the customer to suspend payments. The payment of products already delivered shall not oblige Verum Italy to complete the order. In case of disagreements payments cannot be deferred, unless otherwise agreed. Until the receipt of payment for the total value of the goods ordered, Verum Italy will be and remain the sole and only proprietor of the goods.

RESPONSABILITY

Verum Italy does not accept return of goods without prior approval, in all cases costs for goods returns must be borne by the Customer. Only faulty goods found by Verum Italy Srl will be replaced free of charge without any other indemnity or refund for damage or repairs. Verum Italy is not responsible for any faulty goods which have been manipulated in a bad way. Any damage caused by improper installation or use is not covered by any guarantee. Customers are not authorized to rework Verum Italy products.

CONTROVERSY

Orders are governed by the Italian Law. If the parties cannot reach amicable settlements, disputes shall be referred uniquely to the competent civil court in Milano.

WARRANTY

We certify with our complete and utmost corporate integrity that Verum Italy products are produced solely within our Italian manufacturing facilities, if not expressly indicated. Each piece of hardware, forged or cast is hand-crafted to perfect the uniqueness in design and finish. The guarantee of originality is due to the fact that the finish of each product is slightly different than the previous item. Any imperfections or differences in form, finishes and materials are to be attributed to the technology or manual operations necessary for processing the product. Failure to comply with the instructions and/or a lack of care in use may cause damages for which Verum Italy declines all responsibility.

CLEANING SUGGESTIONS

In order to maintain the quality of the protective treatment and uniqueness of all finishes of Verum Italy products do not attempt to clean with detergents and/or chemicals. Hence, simply use a lightly water moistened cloth to clean the items.

Graphic Design: Alessandro Stabile Design Studio

Verum Italy

Strada Statale Briantea, 40
23892 Bulciago LC
Italia

+39 031 355 9009
info@verumitaly.it

rev. Febbraio 2023

VERUM
ITALY