

BABY CHANGING STATIONS



BABY CHANGING STATIONS

PROVIDING THE HIGHEST LEVEL OF SAFETY

In all businesses that count families with babies among their visitors, there is a need for a comfortable environment where infants can be nursed safely and hygienically.

Safety, strength, quality and usability make the DAN DRYER baby changing stations a popular choice when designing user-friendly, long-life baby changing areas in public and commercial businesses.

Our baby changing stations can be found in various business sectors worldwide – airports, supermarkets, shopping malls, campsites, holiday resorts, hotels, restaurants, amusements parks, cultural centres, sport arenas and on trains operating in Europe.

We have the experience and in-depth knowledge of developing and producing sanitary equipment for commercial and public toilet facilities.

Our strength lies in unique know-how and a company protocol enabling us to respond quickly and flexibly to individual requirements and specifications.



BJÖRK BABY CHANGING STATION

- Wall mounted
- 2-year warranty
- Holds up to 80 kg
- Strong materials with rounded edges for optimal safety
- Torsion springs ensure smooth and easy opening and closing motion
- Available in black, white and all RAL colours
- Ideal for toilets with limited wall space



UNIT WITHOUT BELT
(Certified by TÜV NORD Baumuster
in accordance with DIN EN 12221-1:2008 + A1:2013)



UNIT WITH BELT
(ASTM F2285-04(2016)e1...Diaper Changing Tables for
Commercial Use)

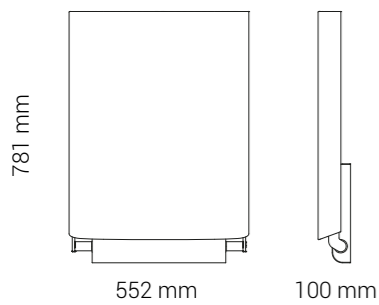

BJÖRK PAPER DISPENSER

- Wall mounted
- 2-year warranty
- Equipped with safety lock
- Holds multi-fold paper towels 34 x 20.3 cm
- Available in black, white and all RAL colours
- Practical and hygienic solution securing a clean changing surface at all times

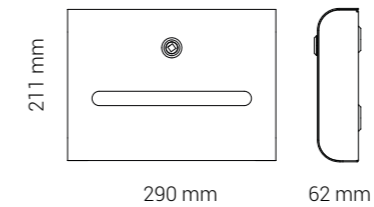

BABY CHANGING MAT

- Available in black and grey
- Hand sewn and easy to clean
- Fastened to the table with velcro
- L: 650 mm x W: 450 mm x H: 20 mm
- For DAN DRYER baby changing stations
- Coated with 100% Oeko-Tex certified PU-leather



AWARDS

BJÖRK BABY CHANGING STATION

- Red Dot Design Award, best of the best, 2017
- German Design Award, 2018
- Good Design, 2018





DAN DRYER BABY CHANGING STATION

- Wall mounted
- 2-year warranty
- Made of cleaning-friendly materials
- Unique carrying capacity of up to 400 kg
- Can be combined with matching paper roll holder
- Space-saving; folds up against the wall when not in use
- Strong safety strap and rounded edges for optimal safety
- Available in white and all RAL colours

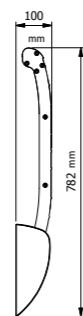
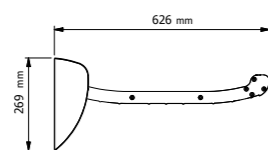
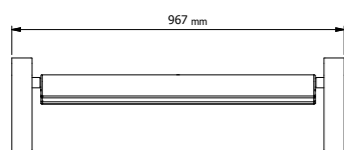
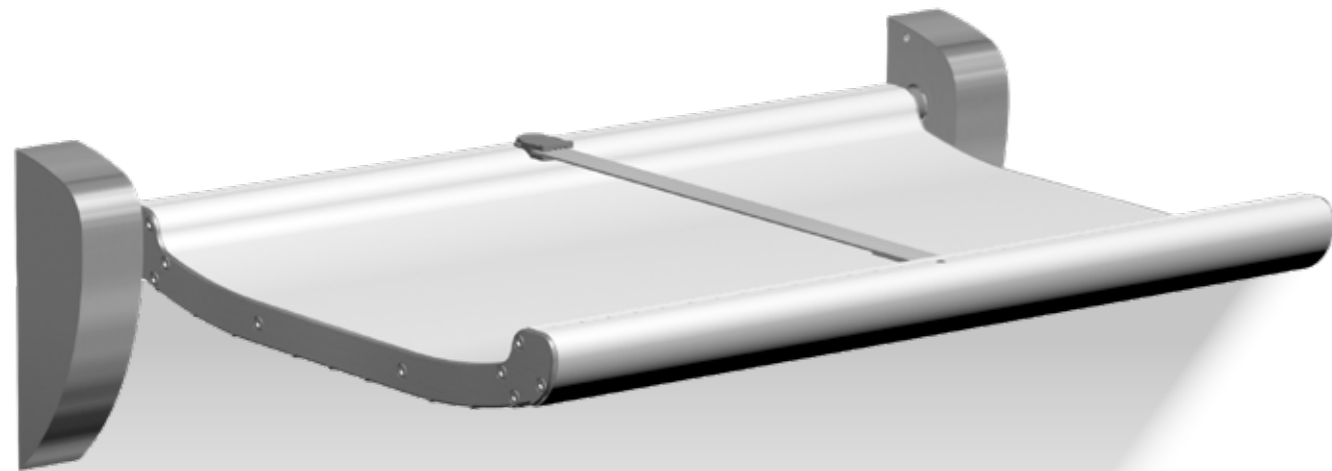

PAPER ROLL HOLDERS

- Wall mounted
- 2-year warranty
- Holds 70 x 10 cm paper rolls
- Very sturdy model with safety locks
- Hygienic solution securing a clean changing surface at all times
- Available in white and all RAL colours

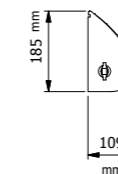
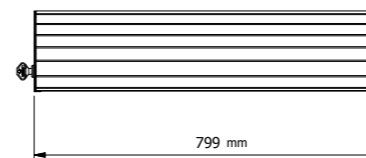

- Wall mounted
- 2-year warranty
- Holds 50 x Ø10 cm paper rolls
- Comes in brushed stainless steel as standard
- Solid locking system makes the holder very sturdy
- Available in stainless and all RAL colours
- Integrated gas spring enables easy one-handed paper refill
- Sight holes make it easy to check how much paper is still left

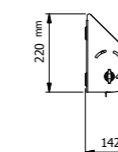
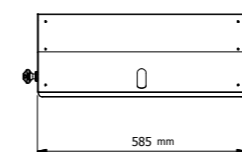



DAN DRYER A/S

Alsikevej 8

DK-8920 Randers NV

Tel: +45 86 41 57 11

Email: info@dandryer.com

dandryer.com