

- RECEPTACLES: two
- INSTALLATION: drilled and mounted behind rigid material
- MATERIALS: polycarbonate
- CONFIGURATION: double linear components, vertical or horizontal

DESCRIPTION

The 22 system is a complete suite of interior surface accessories that challenge the traditional, tired and ubiquitous cover plate concept. The 22 is designed to "mud" directly into drywall without a visible cover plate or trim. Alternatively, it may be set flush into millwork, marble, glass or any other surface. 22 operative components include: power outlets, data & communication, telephone receptacles, cable and HDMI connectors, line voltage on/off switches, keypad controls, and USB.

APPLICATIONS

The 22.2.4 is designed to be used on surfaces other than drywall - for example: millwork, glass, stone, etc. The 22.2.4 will accommodate a wide range of finish material thicknesses and accept any of the 22.3 operative components.

NOTES

- + For use with a standard depth junction box.
- + The 22 system is a departure from conventional cover plate systems, and requires precise and skilled craftsmanship during installation. If you have never installed a 22, Bocci recommends a practice installation.
- + Operative components must both be the same barrel length.
- + Purchase additional components at www.bocci.com/shop/22
- + Please see our installation films on www.bocci.com/22-series/22-alternative-installation

Worldwide utility patents pending
US Patent # 7,956,295 B2 & 8,912,439 B2

Made in Vancouver, Canada

Vancouver
sales@bocci.com
www.bocci.com

Berlin
europe@bocci.com
www.bocci.com



DOUBLE LINEAR MOUNTING PLATE

22.2.4

Design by Omer Arbel
PRODUCT SPECIFICATION

© 2020, Bocci Design and Manufacturing Inc. All rights reserved. Any inquiries should be directed to: info@bocci.com

BOCCI

1

Recess and install the junction box. For appropriate dimension from the front of the finish surface to the mounting plate please cross reference [Barrel Selection Guide](#) for more information.

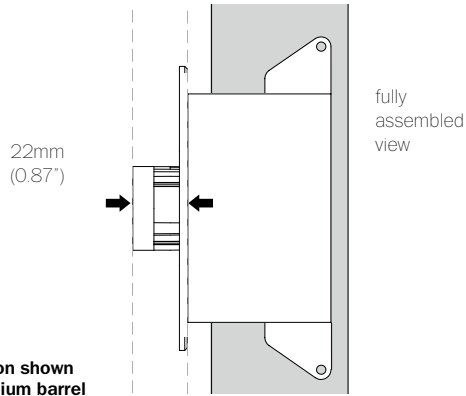
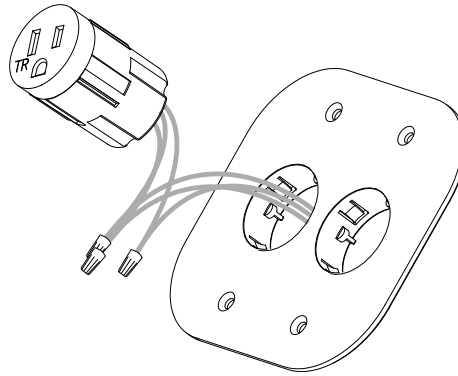

Illustration shown with medium barrel

2

Put the wiring through the junction box. Insert the operative components into the cover plate then make all necessary electrical connections.



3

Mount the cover plate to the junction box using screws provided.

Best practice statement: For ease of future access or maintenance, we recommend a single incoming wire to the junction box (no J-box splices) immediately behind the 22 receptacles.

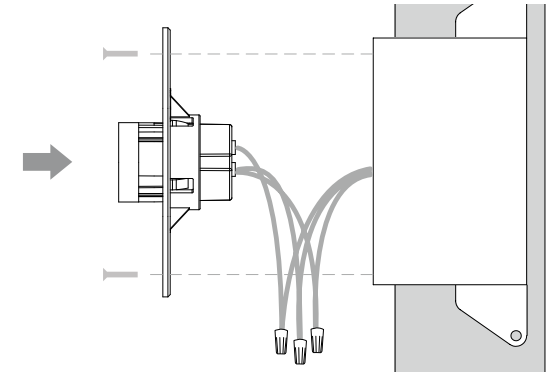

4

Use the drawing below to measure the drill hole locations in your finish material. If you wish to install only one operative component simply drill one 36.5mm (1.44 inch) diameter hole (1-7/16 inch bit size).

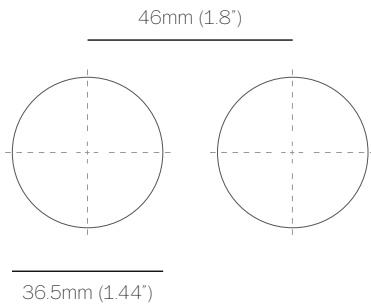

5

Depending on the material, appropriate barrel length can be determined. Please refer to [Barrel Selection Guide](#) for more information.

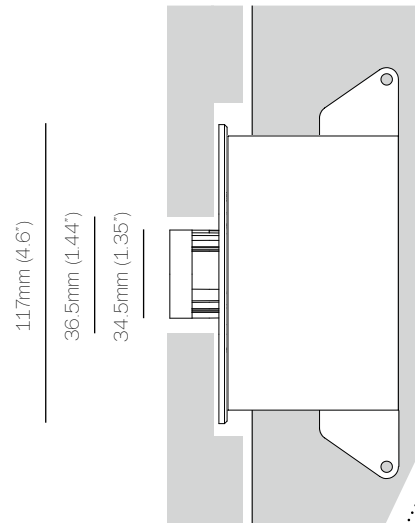
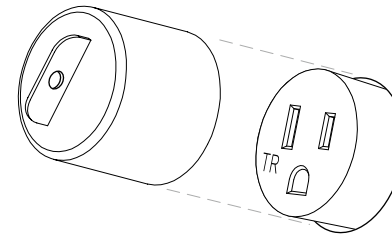

Illustration shown with machined down (soft material) for medium barrel

6

For plaster, mortar, tile, concrete, etc. use the trim cap (22.4) to block the face of the operative components to create the necessary reveal.



7

Install finish material, remove trim cap (22.4).

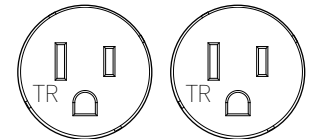

DOUBLE ALTERNATE MOUNTING PLATE

22.2.4

Design by Omer Arbel
PRODUCT INSTALLATION INSTRUCTIONS



For additional assistance, please contact

Vancouver
sales@bocci.com
www.bocci.com

Berlin
europe@bocci.com
www.bocci.com

© 2020, Bocci Design and Manufacturing Inc. All rights reserved. Any inquiries should be directed to: info@bocci.com

BOCCI