

# Fat Thumb Turn

Tom Dixon Collection

d line

## PRODUCT DATA SHEET

ITEM NUMBER	SURFACE
12.9013.02.000	Satin Stainless Steel
12.9013.P4.000	Satin stainless steel, PVD charcoal
17.9013.F1.000	Polished stainless steel, electric blue

### PICTURE



### PRODUCT

Fat Thumb Turn, Ø70, cc30, 36-68, satin finish.

### TENDER TEXT

Fat Thumb Turn, Ø70, cc30, 36-68, satin finish. The FAT collection is a series of architectural hardware pieces designed by English industrial designer Tom Dixon. Angular and bulbous, the pieces are a testament to form following function, whilst maintaining a humorous silhouette and a reductionist aesthetic. FAT is part of a fuller series by Tom Dixon including dining chairs, bar stools and lounge chairs. Material: stainless steel AISI 316 satin finish. W:70 mm x H:70 mm x D:34 mm.

### PRODUCT SPECIFICATION

Dimensions: W:70 mm x H:70 mm x D:34 mm.

Radius: Ø70

Material: stainless steel AISI 316

Surface finish: satin grain 320, crafted by hand

Warranty for stainless steel (non movable ) parts - 20 years

### DRAWING

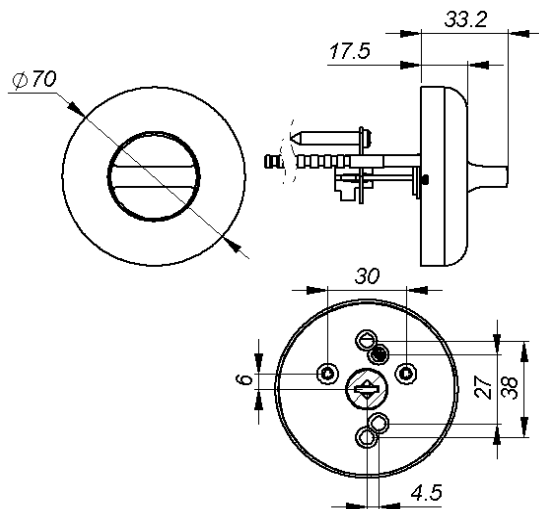

### SPARE PARTS / ACCESSORIES:

14298174750 - Sectioned bolt M5 x 110 mm.

14970100030 - Grub screw M3 x 6 mm.

### MOUNTING:

See instruction supplied with product.

### PACKING:

15 pair per box

### ISO-DRAWING

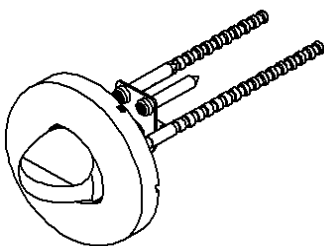

### PRODUCT CARE

To sustain the unique d line finish appearance please follow the below instructions:

- Wash down the surfaces using soapy water or mild detergent
- Always thoroughly rinse off with clean water
- To complete the cleaning procedure dry/polish the surfaces with a soft dry cloth

Please do not use scouring powder, steel wool, chloride based detergents or other aggressive cleaning products as these may damage the surface.

If spots or corrosion appear on the surface it is not due to the stainless steel quality, but to impurities in the environment, aggressive conditions or improper or insufficient cleaning.