

Do **NOT** Use
Ethanol Fuel
For This
Burner



SEASONAL LIVING[®]

INGOT COLLECTION

**SUPER·
BIO·FUEL[™]
BURNER
2022**

**SUPER·BIO·FUEL[™]
FIRE PEDESTALS AND TABLES**



**INGOT FIRE - MANUFACTURER/USER INSTRUCTIONS
UPDATED 2022**

Read all information carefully before operating Fire Pedestals & Tables.

IMPORTANT



MAINTAIN AND KEEP THIS USER MANUAL IN A SAFE, DRY AND EASILY ACCESSIBLE LOCATION. DO NOT DISCARD THIS MANUAL AT ANY TIME.

THESE MANUFACTURER/USER INSTRUCTIONS CAN ALSO BE ACCESSED THROUGH THE QR CODE TO THE LEFT.

Contact us if you require us to mail you a paper copy of these operating instructions or go to <https://www.seasonalliving.com/burner-manual>.

TABLE OF CONTENTS

About Super.Bio.Fuel™ & SBF Starter Fluid 4

Safety Data Seet (SDS) - Super.Bio.Fuel 5

Safety Data Sheet (SDS) - SBF Starter Fluid..... 9



1. Inspection | Handling of Your Purchase 13

2. Assembly and Warnings 19

3. Fueling | Lighting Burner..... 28

4. Extinguishing the Burner 33

5. Refueling the Burner..... 34

6. Proper Use of Your Purchase 35

7. Caring | Storing Your Purchase 40

8. Ordering Information 43

9. Warranty Information 44

10. Product Care Instrucations 48

A superior fireplace fuel with these benefits.

- Non-Flammable, yet combustible, and economical to burn.
- Most cost-effective fuel - burns longer than ethanol.
- Suitable for indoor/outdoor burning
- No toxins, odor, or residue
- No shipping+storage restrictions; it's rated non-hazardous.
- 20, 140 BTUs / Liter / Shipping Weight: 12 Pack-25lbs
- Packed Eleven 1-Liter Bottles + One 1-Liter Bottle of Starter Fluid



12 Pack (11+1)

SBF Fireplace + FirePit Inserts, designed for safety | SUPER.BIO.FUEL™ - the safer fuel alternative!

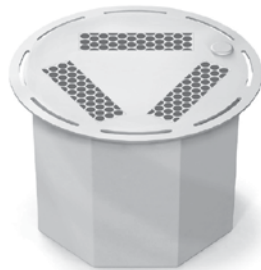

Burners shown below burn ONLY SUPER.BIO.FUEL™

AR8-3L/R 8.06" Round Burner - 3 Liter

Dimensions: 8.06" Diameter (top) x 5.5" High
Cutout: 7.5" Diameter
Fuel Capacity: 3.0 Liters - SUPER.BIO.FUEL™
Burn Time: 5.5+/- Hours (approx)
Weight: 2.5 Lbs (empty) / 9.1 Lbs (full)
Lid: Included, not shown



AR12-7.6L/R 12.25" Round Burner - 7.6 Liter

Dimensions: 12.25" Diameter (top) x 6.45" High
Cutout: 10.75" Diameter
Fuel Capacity: 7.6 Liters - SUPER.BIO.FUEL™
BTUs: 10, 140 BTUs / hour (approx)
Burn Time: 7.6+/- Hours (approx)
Weight: 6 Lbs (empty) / 23 Lbs (full)
Lid: Included, not shown



For website ordering: bit.ly/sbf-ordering | e: Info@marbledimensions.com

FUEL MANUFACTURER INSTRUCTIONS

Read all information carefully before using.

SUPER•BIO•FUEL™



TERMS OF SALE FOR ALL FUEL PURCHASES:

- All Sales final
- No Returns
- No Exchanges
- No split cartons
- The fuel is only available in 12 liter packs consisting of 11 liter bottles of Super.Bio.Fuel and 1 liter bottle of SBF Starter Fluid
- Seasonal Living DOES NOT sell any of these fuels. Fuels ONLY available through Marble Dimensions Worldwide

HOW TO ORDER FUEL:

See page 43 in this user manual for ordering information.



For website ordering: bit.ly/sbf-ordering | e: Info@marbledimensions.com

STRICTLY FOLLOW FUEL MANUFACTURER INSTRUCTIONS



Page: 1 of 3

1. IDENTITY super•bio•fuel™

Marble Dimensions Worldwide
731 Congress Park Drive
Dayton, Ohio 45459

United States Version: Preparation Date: 22/Feb/2013 Revision Date: 22/Aug/2021

For Information: +1 937.435.7900
Online Safety + Emergency Info www.marbledimensions.com

For Chemical Emergency
Spill, Leak, Fire, Exposure, or Accident
Call CHEMTREC Day or Night **+1 800.424.9300**

Chemical Name: ORGANIC SUPER-BIO-FUEL™ / NON-FLAMMABLE*
Manufacturer's Code: SBF Formula 8-888
Trade Name: SUPER-BIO-FUEL™
HMIS:

Health: 0
Flammability: 1
Reactivity: 0
Product Appearance and Odor: Clear, colorless liquid; odorless, and odorless when burned.



2. INTENDED USE

Fuel for Indoor and Outdoor Ventless Fireplaces, Party Lights, Fire Pots, Fire Pits and Wicked Devices. Requires engineered fiberglass batting or wicks to start and sustain a flame. Not for human or animal consumption.

3. HAZARDOUS INGREDIENTS / INFORMATION ON INGREDIENTS

May cause eye or skin irritation with susceptible persons. May be harmful if swallowed. No components are believed to be hazardous, or listed in the NIOSH Recommendations for Occupational Safety and Health Standards 1988 or are listed as hazardous by SARA, CERCLA, or RCRA. No OSHA PEL's are established for any of the other ingredients. This fuel has no substances that are listed in the California Safe Drinking Water and Toxic Enforcement Act of 1986, codified at Health and Safety Code section 25249.5 et seq., commonly referred to as "Proposition 65". Not a dangerous substance or mixture according to the Globally Harmonized System (GHS)

Non Hazardous Components* [* trade secret, name withheld: hazards and treatments fully disclosed]

Proprietary Diol	CAS *	Weight: 75%-97%
Proprietary Ingredient	CAS *	Weight: 1%-7%

4. FIRST AID PROCEDURES / NO KNOWN IRRITANTS

Acute Effects:	Possible Effect	Remedy
Eyes:	May cause slight irritation.	Flush area with cool water for 15 minutes.
Skin:	May cause slight irritation.	Rinse area well with soapy water as a precaution.
Ingestion:	May be harmful if swallowed.	Drink water to dilute, seek medical attention.
Inhalation:	Avoid sustained breathing of vapors or mist from liquid.	Move to fresh air and ventilate area.
Chronic Effects:	Repeated, excessive exposures may cause central nervous system effects.	
Aggravated Medical Conditions:	Central Nervous System	
Potential Environmental Effects:	See Section 11 for additional information	
Toxicological Information:	See Section 10 for additional information	

5. FIRE FIGHTING INFO

Flammable Properties: May ignite if exposed to intensive heat and a source of ignition. Unable to ignite under 200° F. Material may pose a fire risk hazard because it is dispersed (or spread) by water stream.

Suitable Extinguishing Media: Extreme wetting and cooling agents, Dry Powder, Alcohol-resistant foam. Carbon dioxide (CO2). Use extinguishing measures that are appropriate to local circumstances and the surrounding environment.

Unsuitable Extinguishing Media: Do not use a solid water stream as it may scatter and spread fire.

Unsuitable Combustion Products: Thermal decomposition (bulk spill) can lead to release of irritating gases and vapors, Carbon dioxide (CO2).

Explosion Data:

Sensitivity to impact:	No information available. Highly unlikely.
Sensitivity to static discharge:	No information available. Highly unlikely. Flash Point: 200° F (unable to ignite under 200° F)
Specific Hazards:	Risk of ignition above 200° F. Keep product and empty container away from heat and sources of ignition.

6. ACCIDENTAL RELEASE MEASURES

Personal Precautions: Ensure adequate ventilation. Avoid high-pressure washing or generation of aerosols. Use personal protective equipment. Material can create slippery conditions.

Environmental Precautions: Prevent further leakage or spillage if safe to do so.

Cleanup Methods: Soak up with inert absorbent material. Pick up and transfer to properly labeled containers.



For website ordering: bit.ly/sbf-ordering | e: Info@marbledimensions.com

STRICTLY FOLLOW FUEL MANUFACTURER INSTRUCTIONS



7. HANDLING & STORAGE

Handling Ensure adequate ventilation.
Storage Keep in a dry cool place. Reseal containers after opening. To maintain product quality, do not store in heat or direct sunlight. Keep at temperatures not exceeding 104° F.

8. PHYSICAL CHARACTERISTICS

Appearance: Clear liquid.
pH: No information available.
Odor: Mild Sweet antiseptic (Astringent) Does not contain D-Limonenes.
Flash Point: 200° F / Will not ignite below 200° F.
Auto-Ignition: Above 1,000° F.
Water Solubility: Miscible.
Shelf Life: Five (5) Years when stored in closed containers between 32°F and 95°F. Avoid freezing and thawing.
Residue: Non after burning.

9. STABILITY & REACTIVITY

Chemical Stability: Stable under normal conditions.
Conditions to Avoid: Extremes of temperature and direct sunlight.
Incompatible Materials: Strong acids. Strong bases. Strong oxidizing agents.
Hazardous Decomposition Products: No Information Available.
Hazardous Reactions: Hazardous polymerization does not occur.

10. TOXICOLOGICAL INFORMATION

ACUTE TOXICITY, Product Information.

LD50 Oral: No Information Available.
LD50 Dermal: No Information Available.
LD50 Inhalation: No Information Available.

TOXICOLOGICAL DATA FOR THE COMPONENTS

Chemical Name	Weight %	LS50 Oral	LD50 Dermal	LD50 Inhalation
Proprietary Diol	75-95%	20,000 mg/kg Rat	20,800 mg/kg Rabbit	>317042 mg/m ³ air
Proprietary Additive	2-15%	N/A	N/A	N/A
Proprietary Ingredient	2-5%	90 mg/kg Rat	N/A	N/A

CHRONIC EFFECTS: No component of this product present at levels greater than 0.1% is identified as a known or anticipated carcinogen.

OSHA Not Listed.
ACGIH Not Listed.
NTP Not Listed.
Mexico Not Listed.
IARC Not Listed.

Irritation:

Eye, rabbit 500 mg 24H MLD

Sensitization:

No Information Available

Mutagenic Effects:

No Information Available

Developmental Effects:

Animal testing did not show any effects on fetal development

Corrosivity:

No Information Available

Neurological Effects:

No Information Available

Reproductive Effects:

No Information Available

Target Organ Effects:

No Information Available

11. ECOLOGICAL INFORMATION

ECO-TOXICITY EFFECTS, Component Information.

Chemical Name (Trade Secret)	Weight %	Acute Fish Toxicity	Daphnia (water flea)	Other
Proprietary Diol	75-95%	LC50: 96h 40,613 mg/L (Oncorhynchus mykiss) static static LC50: 96h 51,400 mg/L (Pimephales promelas) static LC50: 96h 51,600 mg/L (Oncorhynchus mykiss) static	EC50: 48h 1,000 mg/L (Daphnia magna) EC50: 24h 10,000 mg/L (Daphnia magna)	Saltwater Algae Skeletonema costatum DC50: 96h 19,1000 mg/L

Persistence / Degradability:

Expected to be biodegradable.

Bioaccumulation / Accumulation:

No Information Available.

Mobility:

Mobile with water.



For website ordering: bit.ly/sbf-ordering | e: Info@marbledimensions.com

STRICTLY FOLLOW FUEL MANUFACTURER INSTRUCTIONS



Page: 3 of 3

12. DISPOSAL CONSIDERATIONS:

Whenever possible, as rules and regulations allow, please recycle or manage materials to minimize waste.

Waste Disposal Methods: Dispose of in compliance with the laws and regulations pertaining to this product in your jurisdiction.

Contaminated Packaging: Empty containers should be decontaminated and taken for local recycling, recovery or waste disposal.

13. TRANSPORT INFORMATION:

Domestic transport regulations (USA)

DOT Not regulated

Domestic transport regulations (Canada)

TDG Not regulated

Domestic transport regulations (Mexico)

MEX Not regulated

International transport regulations

ICAO Not regulated. IATA Not regulated. IMDG/IMO Not regulated.

14. REGULATORY INFORMATION:

USA:

Federal Regulations

Ozone Depleting Substances:

No Class I or Class II material is known to be used in the manufacture of, or contained in, this product.

SARA 313

Section 313 of Title III of the Superfund Amendments and Reauthorization Act of 1986 (SARA).

This product is not known to contain any chemicals which are subject to the requirements and regulations contained in 40 CFR 372.

SARA 302

This product is not known to contain any chemicals which are expected to be subject to the requirements and regulations contained in 40 CFR 302

SARA 311/312 Hazardous Categorization

Acute Health Hazard No

Chronic Health Hazard No

Fire Hazard No

Sudden Release of Pressure Hazard

Reactive Hazard No

Clean Air Act, Section 112 Hazardous Air Pollutants (HAPs) (see 40 CFR 61) May contain trace HAPs.

15. OTHER INFORMATION

The information provided herein is given in good faith, but no warranty, expressed or implied, is made.

The information presented in this MSDS is believed to be factual. However, nothing contained in this information is to be taken as a warranty of any kind by Lumina Products Inc. The user should review any recommendations, in the specific context of the intended use, to determine whether they are appropriate.

END REPORT



For website ordering: bit.ly/sbf-ordering | e: Info@marbledimensions.com

FUEL MANUFACTURER INSTRUCTIONS

Read all information carefully before using.

SBF STARTER FLUID



TERMS OF SALE FOR ALL FUEL PURCHASES:

- All Sales final
- No Returns
- No Exchanges
- No split cartons
- The fuel is only available in 12 liter packs consisting of 11 liter bottles of Super.Bio.Fuel and 1 liter bottle of SBF Starter Fluid
- Seasonal Living DOES NOT sell any of these fuels. Fuels ONLY available through Marble Dimensions Worldwide

HOW TO ORDER FUEL:

See page 43 in this user manual for ordering information.



For website ordering: bit.ly/sbf-ordering | e: Info@marbledimensions.com

STRICTLY FOLLOW FUEL MANUFACTURER INSTRUCTIONS



Page: 1 of 3

1. IDENTITY

SBF STARTER FLUID

Marble Dimensions Worldwide
731 Congress Park Drive
Dayton, Ohio 45459

United States Version: Preparation Date: 13/Jun/2016 Revision Date: 30/Aug/2021

For Information: +1 937.435.7900
Online Safety + Emergency Info www.marbledimensions.com

For Chemical Emergency
Spill, Leak, Fire, Exposure, or Accident
Call CHEMTREC Day or Night +1 800.424.9300

Chemical Name: SUPER-BIO-FUEL™ + Ethyl Alcohol
Manufacturer's Code: SBF-STARTER FLUID
Trade Name: SUPER-BIO-FUEL™ STARTER FLUID

HMIS:

Health: 2
Flammability: 3
Reactivity: 0



Product Appearance and Odor: Clear, colorless liquid; antiseptic smell, odorless when burned.

2. INTENDED USE

Starter Fluid for use only to ignite SUPER.BIO.FUEL being used for Indoor and Outdoor Ventless Wicked Devices designed to burn SUPER.BIO.FUEL.

3. HAZARDOUS INGREDIENTS / INFORMATION ON INGREDIENTS

May cause eye or skin irritation with susceptible persons. May be harmful if swallowed. No components are believed to be hazardous, or listed in the NIOSH Recommendations for Occupational Safety and Health Standards 1988 or are listed as hazardous by SARA, CERCLA, or RCRA. No OSHA PEL's are established for any of the other ingredients. This fuel has no substances that are listed in the California Safe Drinking Water and Toxic Enforcement Act of 1986, codified at Health and Safety Code section 25249.5 et seq., commonly referred to as "Proposition 65". Not a dangerous substance or mixture according to the Globally Harmonized System (GHS)

Ingredients [* trade secret, name withheld: hazards and treatments fully disclosed]

Proprietary Diol	CAS *	Weight: 45%-55%
Proprietary Ingredient	CAS *	Weight: 1%-3%
Ethyl Alcohol	CAS 64-17-5	Weight: 45%-55%

4. FIRST AID PROCEDURES / NO KNOWN IRRITANTS

Acute Effects:	Possible Effect	Remedy
Eyes:	May cause slight irritation.	Flush area with cool water for 15 minutes.
Skin:	May cause slight irritation.	Rinse area well with soapy water as a precaution.
Ingestion:	May be harmful if swallowed.	Drink water to dilute, seek medical attention.
Inhalation:	Avoid sustained breathing of vapors or mist from liquid.	Move to fresh air and ventilate area.
Chronic Effects:	Repeated, excessive exposures may cause central nervous system effects.	
Aggravated Medical Conditions:	Central Nervous System	
Potential Environmental Effects:	See Section 11 for additional information	
Toxicological Information:	See Section 10 for additional information	

5. FIRE FIGHTING INFO

Flammable Properties: At temperatures above 58° F Starter Fluid will ignite if exposed to source of ignition. Material may pose a fire risk hazard because it is dispersed (or spread) by water stream.

Suitable Extinguishing Media: Extreme wetting and cooling agents, Dry Powder, Alcohol-resistant foam. Carbon dioxide (CO2). Use extinguishing measures that are appropriate to local circumstances and the surrounding environment.

Unsuitable Extinguishing Media: Do not use a solid water stream as it may scatter and spread fire.

Unsuitable Combustion Products: Thermal decomposition (bulk spill) can lead to release of irritating gases and vapors, Carbon dioxide (CO2).

FLASH POINT: 58°F (14°C) TCC
70°F (21°C) TOC

NIOSH approved respirators should be worn. Use water spray to cool equipment and to disperse vapors. Alcohol flames may be difficult to see because they are virtually colorless. Extinguishing Media: Water, carbon dioxide, "alcohol-type foam", or dry chemical.

6. ACCIDENTAL RELEASE MEASURES

Eliminate all source of ignition. Stop leak if without risk. Flush spill away with water spray.
Wear NIOSH approved respirator.

Personal Precautions: Ensure adequate ventilation. Avoid high pressure washing. Use personal protective equipment.
Cleanup Methods: Soak up with inert absorbent material. Pick up and transfer to properly labeled containers.



For website ordering: bit.ly/sbf-ordering | e: Info@marbledimensions.com

STRICTLY FOLLOW FUEL MANUFACTURER INSTRUCTIONS



7. HANDLING & STORAGE

Handling
Storage

Ensure adequate ventilation.
Keep in a dry cool place. Reseal containers after opening. To maintain product quality, do not store in heat or direct sunlight. Keep at temperatures not exceeding 104° F.

Material is classified as a flammable liquid. Keep liquid and its vapors away from heat, sparks, open flame and ignition sources.

8. PHYSICAL CHARACTERISTICS

Appearance: Clear liquid.
pH: No information available.
Odor: Mild Sweet antiseptic (Astringent) Does not contain D-Limonenes.
Flash Point: 58° F / Will not ignite below 58° F.
Auto-Ignition: Above 1,000° F.
Water Solubility: Miscible.
Residue: None after burning.

9. STABILITY & REACTIVITY

Chemical Stability: Stable under normal conditions.
Condition to Avoid: Heat, sparks, open flame, extreme heat.
Materials to avoid: Oxidizing materials can cause vigorous reaction
Hazardous Decomposition: None. Like any other organic material, combustion will produce carbon dioxide and possible carbon monoxide.
Hazardous Reactions: Hazardous polymerization does not occur.

10. TOXICOLOGICAL INFORMATION

ACUTE TOXICITY, Product Information.

LD50 Oral: No Information Available.
LD50 Dermal: No Information Available.
LD50 Inhalation: No Information Available.

TOXICOLOGICAL DATA FOR THE COMPONENTS

Chemical Name	Weight %	LS50 Oral	LD50 Dermal	LD50 Inhalation
Proprietary Diol	45-55%	20,000 mg/kg Rat	20,800 mg/kg Rabbit	>317042 mg/m ³ air
Proprietary Additive	1-7%	N/A	N/A	N/A
Ethyl Alcohol	45-50%		N/A	N/A

Overexposure maybe fatal if swallowed. Harmful if inhaled or absorbed through the skin. Causes skin, eye, and upper respiratory track infection. Can cause central nervous system depression.

CHRONIC EFFECTS: No component of this product present at levels greater than 0.1% is identified as a known or anticipated carcinogen. Possible damage to liver, heart and kidneys if ingested.

OSHA	Not Listed.	NTP	Not Listed.
ACGIH	Not Listed.	IARC	Not Listed.

Irritation:

Eye, rabbit 500 mg 24H MLD

Sensitization:

No Information Available

Mutagenic Effects:

No Information Available

Developmental Effects:

Animal testing did not show any effects on fetal development

Corrosivity:

No Information Available

Neurological Effects:

No Information Available

Reproductive Effects:

No Information Available

Target Organ Effects:

No Information Available



For website ordering: bit.ly/sbf-ordering | e: Info@marbledimensions.com

STRICTLY FOLLOW FUEL MANUFACTURER INSTRUCTIONS



11. ECOLOGICAL INFORMATION

ECO-TOXICITY EFFECTS, Component Information.

Chemical Name (Trade Secret)	Weight %	Acute Fish Toxicity	Daphnia (water flea)	Other
Proprietary Diol	45-55%	LC50: 96h 40,613 mg/L (Oncorhynchus mykiss) static	EC50: 48h 1,000 mg/L (Daphnia magna)	Saltwater Algae Skeletonema costatum DC50: 96h
		EC50: 24h 10,000 mg/L	19,100 mg/L (Daphnia magna)	
		LC50: 96h 51,400 mg/L (Pimephales promelas) static		
		LC50: 96h 51,600 mg/L (Oncorhynchus mykiss) static		
Ethyl Alcohol	45%-55%	No ingredients that are listed in California "Proposition 65"		

Persistence / Degradability: Expected to be biodegradable. **Mobility:** Mobile with water.
Bioaccumulation / Accumulation: No Information Available.

12. DISPOSAL CONSIDERATIONS:

Whenever possible, as rules and regulations allow, please recycle or manage materials to minimize waste.

Waste Disposal Methods: Dispose of in compliance with the laws and regulations pertaining to this product in your jurisdiction.

Contaminated Packaging: Empty containers should be decontaminated and taken for local recycling, recovery or waste disposal.

13. TRANSPORT INFORMATION:

Domestic transport regulations (USA)

DOT: Ship as LIMITED QUANTITY when bottles in 1-Liter Bottles

14. REGULATORY INFORMATION:

USA:

Federal Regulations

Ozone Depleting Substances:

No Class I or Class II material is known to be used in the manufacture of, or contained in, this product.

SARA 313

Section 313 of Title III of the Superfund Amendments and Reauthorization Act of 1986 (SARA).

This product is not known to contain any chemicals which are subject to the requirements and regulations contained in 40 CFR 372.

SARA 302

This product is not known to contain any chemicals which are expected to be subject to the requirements and regulations contained in 40 CFR 302

SARA 311/312 Hazardous Categorization

Acute Health Hazard	No
Chronic Health Hazard	No
Fire Hazard	Yes

Sudden Release of Pressure Hazard

Reactive Hazard	No
-----------------	----

Clean Air Act, Section 112 Hazardous Air Pollutants (HAPs) (see 40 CFR 61) May contain trace HAPs.

California Regulations

This starter fluid has no substances, and no components that are listed in the California Safe Drinking Water and Toxic Enforcement Act of 1986, codified at Health and Safety Code section 25249.5 et seq., commonly referred to as "Proposition 65".

15. OTHER INFORMATION

The information provided herein is given in good faith, but no warranty, expressed or implied, is made.

The information presented in this MSDS is believed to be factual. However, nothing contained in this information is to be taken as a warranty of any kind by Lumina Products Inc. The user should review any recommendations, in the specific context of the intended use, to determine whether they are appropriate.

END REPORT



For website ordering: bit.ly/sbf-ordering | e: Info@marbledimensions.com

INGOT FIRE MANUFACTURER | USER INSTRUCTIONS

1

INSPECTION | HANDLING OF YOUR PURCHASE

a Carefully inspect packaging to ensure no damage. Report any damages immediately upon receipt to Dealer from whom you purchased this product.

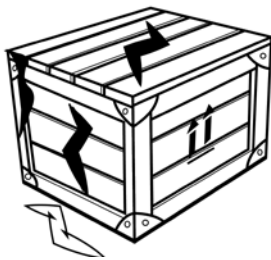
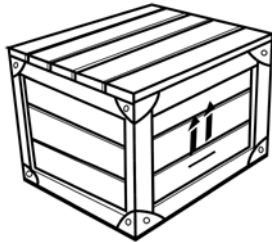

If any damage to carton box or crate, photograph and record on the delivery Bill of Lading (BOL).

- Immediately contact the delivery shipping company as a claim needs to be filed.
- Within 48 hours of receipt of your merchandise, contact your dealer if any items are damaged.
- Retain all damaged merchandise and packaging materials until the shipping claim is resolved. Failure to retain (until you are instructed in writing to discard), may result in your claim being denied.

b



CHECK THAT YOU HAVE RECEIVED ALL PACKAGES

There should be a total of 3 packages:

- 1 x carton box =
- 1 x Super.Bio.Fuel Burner™ with Stainless Steel Burner Lid with Handle
- 1 x carton box =
- 1 x Glass Fire Guard | Wind Shield
- 1 x Wooden crate =
- 1 x Fire Pedestal OR Fire Table

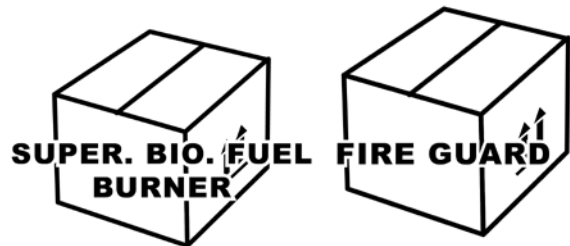

INGOT FIRE MANUFACTURER | USER INSTRUCTIONS

1

INSPECTION | HANDLING OF YOUR PURCHASE

c LOOK FOR ALL WARNING LABELS ON EXTERIOR OF PACKAGING

Pay attention to any Warning Symbols, Directions on how to handle/open carton boxes or crating.

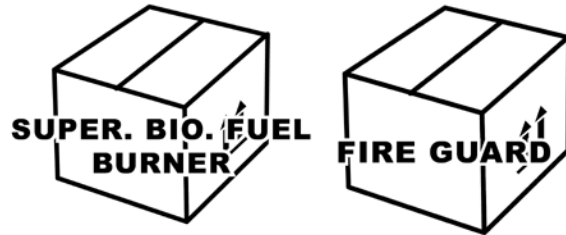
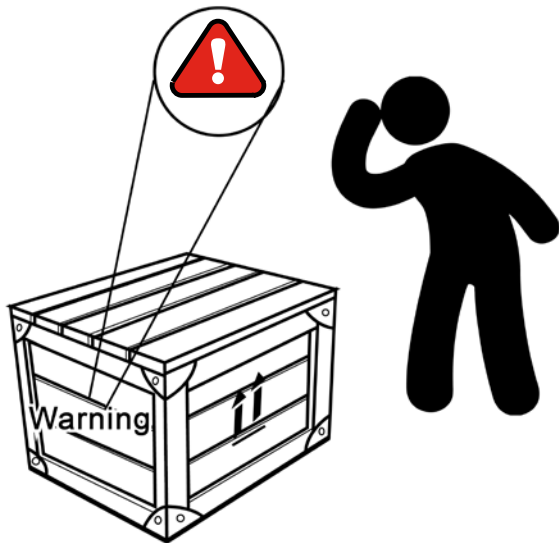

e Carefully open the packing so as not to damage the packed item(s).

f LOOK for & Read complete Manufacturer/ End User Operating instructions, handling, and set up to ensure the product is assembled correctly.



d Retain Box/Crates for Storage of Burner (and other components) when not in use

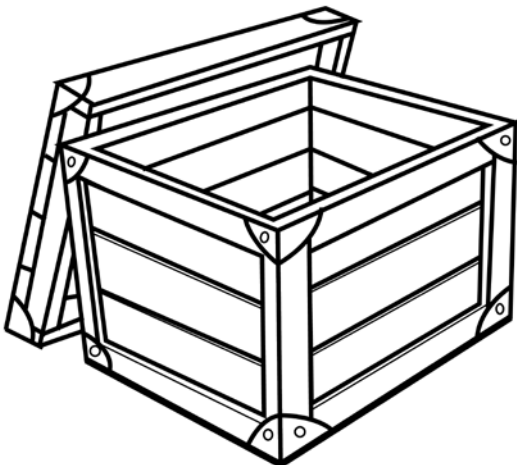

IMPORTANT! Retain all Manufacturer operating instructions. Always keep instructions nearby for easy reference



Failure to read, understand and closely follow instructions may lead to: Loss of Property, Severe Burns and / or Death. **NEVER LEAVE CHILDREN UNATTENDED IN THE VICINITY OF A FIRE AT ANY TIME**

1

INSPECTION | HANDLING OF YOUR PURCHASE

EXAMPLES OF OUR FIRE TABLES

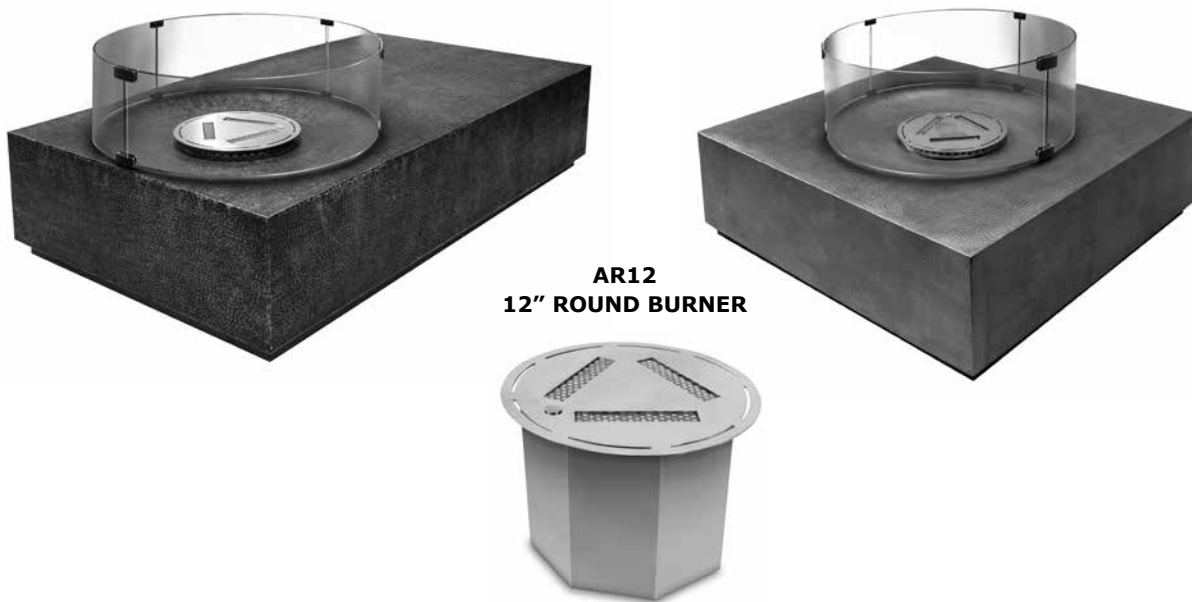

EXAMPLES OF OUR FIRE PEDESTALS



INGOT FIRE MANUFACTURER | USER INSTRUCTIONS

1 BREAKDOWN OF PARTS

g Layout all parts and check against Manufacturer/End User Operating Instructions that you have complete parts ready for set-up. If you are missing any components, contact the Dealer where you purchased this item from. **DO NOT IGNITE OR OPERATE** any of these fires if you have damage to or are missing any parts.

Super.Bio.Fuel™ Stainless Steel Burner with Fiber Wick inserted into burner (white fiber). Burner should include fuel port with small round stainless-steel port cover.

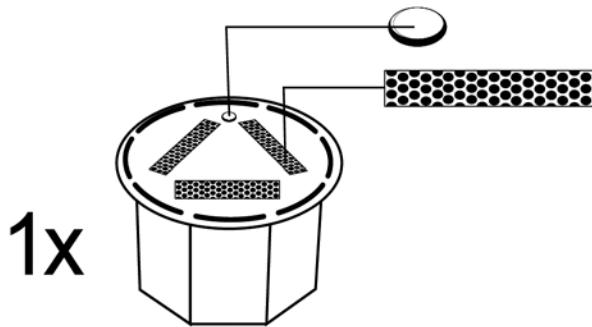

Fire Table Base or Fire Pedestal

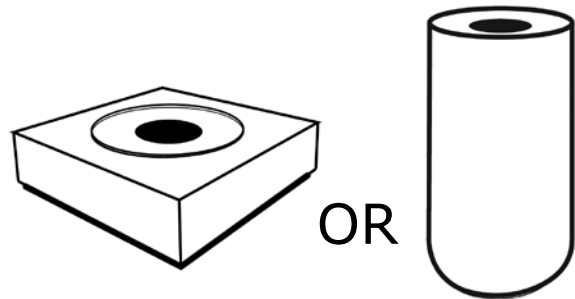

Stainless-steel Burner Lid with Handle.



Wind | Fire Guard Kit
4 curved pieces of tempered glass +
8 Assembly clips (4 for top assembly and
4 with rubber feet for base assembly)

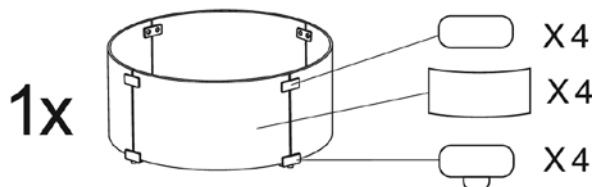

INGOT Fire Manufacturer/User Instructions



Failure to read, understand and closely follow instructions may lead to: Loss of Property, Severe Burns and / or Death. NEVER LEAVE CHILDREN UNATTENDED IN THE VICINITY OF A FIRE AT ANY TIME

INGOT FIRE MANUFACTURER | USER INSTRUCTIONS

1 INSPECTION | HANDLING OF YOUR PURCHASE

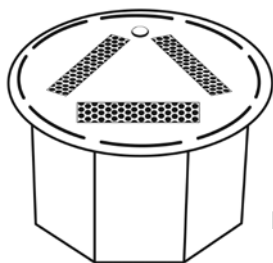

No Moisture



No Debris

- h** Read the Label on outside of Burner Packaging, refer to Seasonal Living Webpage for use

Contact the Dealer you purchased product from if burner is missing any parts or has any damage.

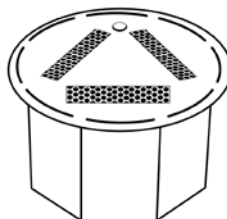

DO NOT operate the burner if burner has any missing parts or damages

If there is ANY damage:

- j** Call your Dealer immediately and take photos of the damage and be prepared to return the item to the Dealer for replacement.
- k** Inspect the Burner thoroughly to make sure it is free of any debris or liquid.



- i** Carefully inspect burner for any damage.

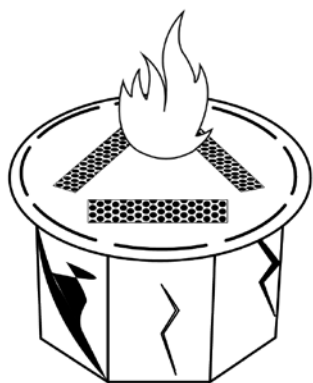
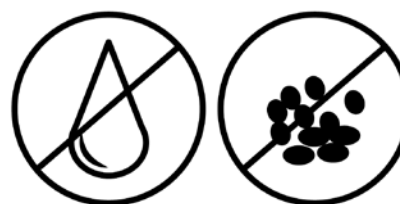

NO

Do not use if any dents, cracks or any missing parts.

- l** Make certain that the new Burner has no Debris e.g. packing material, paper, plastic, foam in the fuel storage cavity prior to filling the burner.
- m** Set Burner aside in a safe place. DO NOT add fuel until you are ready to use Burner.

INGOT FIRE MANUFACTURER | USER INSTRUCTIONS

1

INSPECTION | HANDLING OF YOUR PURCHASE

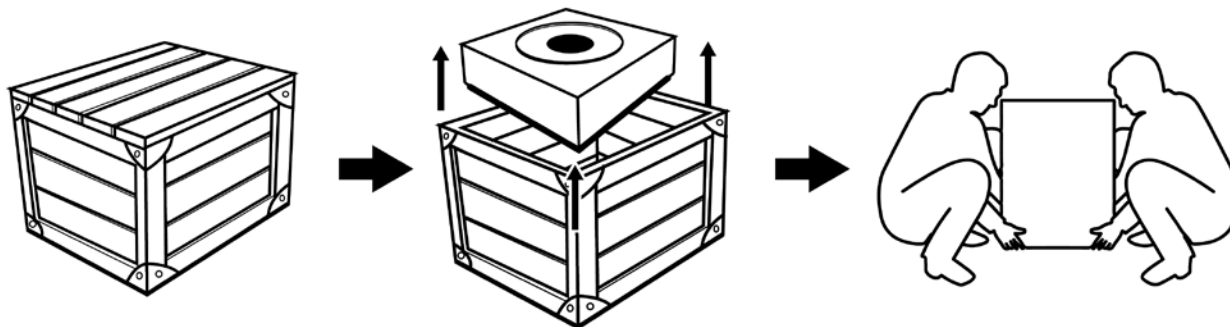

n Using help from another strong and physically capable adult, locate fire table and or fire pedestal to desired location

Do Not attempt to move Fire Table or Pedestal without help from another person to help with placement as moving the table without assistance could damage the substrate frame, damage levelers for height adjustment or simply damage the finished product if moved improperly and placed in the final installation.

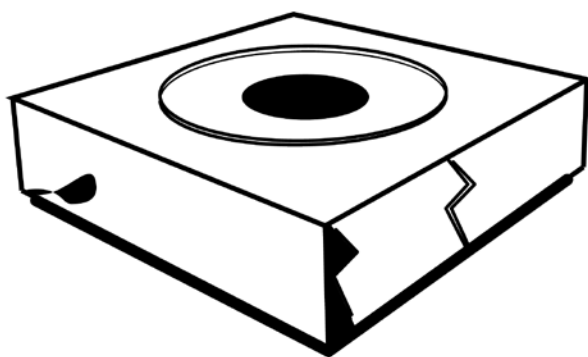

o **Unpack Fire Table or Fire Pedestal and check product carefully for all parts (see page 13) and or any damage.** If any damage, contact the selling Dealer and **DO NOT ASSEMBLE** or attempt to **OPERATE** fire table.

2

ASSEMBLY AND WARNINGS

Make sure that you locate fire pedestal or fire table in a well-ventilated indoor room or in a suitable outdoor location that is well vented.

Do not install or position fire table or fire pedestal in a location that does not have adequate ceiling clearance from the top of each fire table or fire pedestal. Follow recommended clearances below.

Do not install or position Fire Table or Fire Pedestal in a location that does not have adequate clearance on all sides of the fire table and fire pedestal.

Follow these recommended Manufacturer clearances.

- Fire Pedestal, we recommend a minimum of 60 inches/153 CMS clearance overhead.
- Fire Table, we recommend at least 96 inches/ 244 CMS clearance overhead.
- We recommend at least 24 inches/ 61 CMS clearance.

Fire Pedestals should only be located in sheltered areas AND secured in place to protect them from falling over either due to strong winds or due to active walkways or corridors.

WARNING!–Failure to install in a safe location can result in: fire, loss of property, severe burns, injury and or death. Please take great caution in setting up your new Fire Table or Fire Pedestal to ensure safe location exists and proper clearances are adhered to for safety.

Read all labels and Warning Labels thoroughly to ensure proper use and installation.

End User must ensure that the Fire Tables and Fire Pedestals are installed on a solid level surface free of any debris or trash. Always keep trash or debris away from fire pedestal or fire pedestal to avoid uncontrollable fire

Make sure that there are no hanging trees, plants, wall covering, tents, overhead fabrics of any type, in the way of the ignited burner always maintaining all proper clearances are observed by the end user

INGOT FIRE MANUFACTURER | USER INSTRUCTIONS

PROPER INSTALLATION AND POSITION OF THE FIRE PEDESTAL

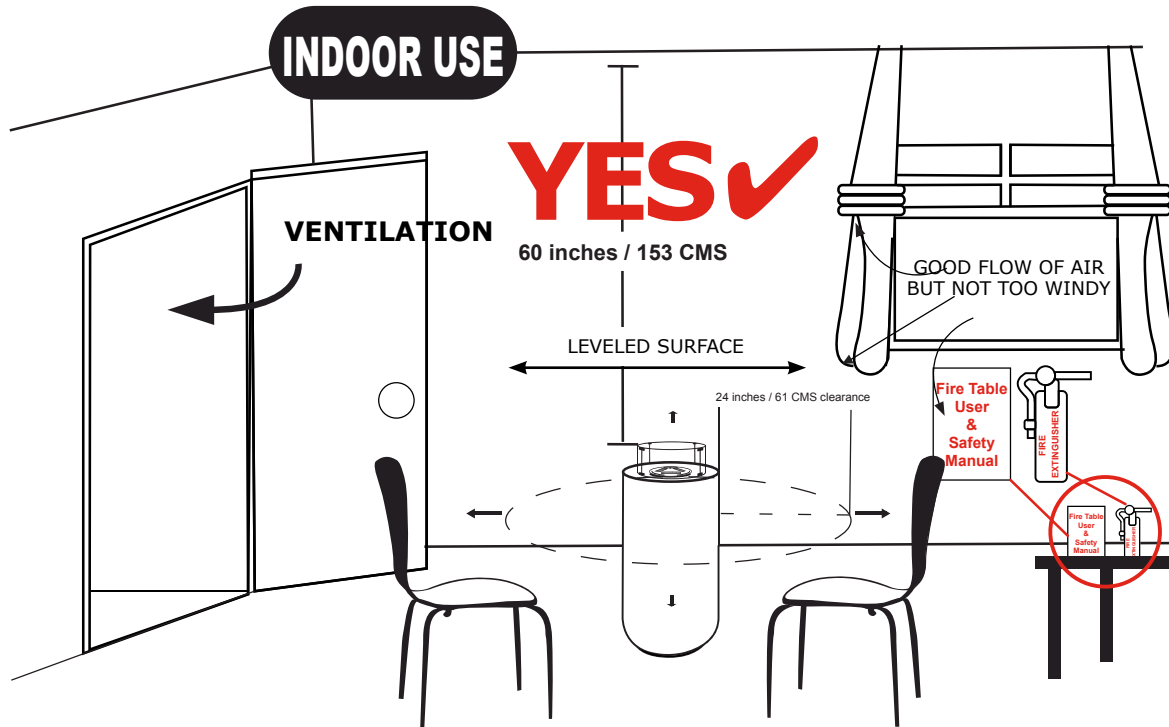

IMPROPER INSTALLATION AND POSITION OF THE FIRE PEDESTAL



INGOT FIRE MANUFACTURER | USER INSTRUCTIONS

PROPER INSTALLATION AND POSITION OF THE FIRE TABLE

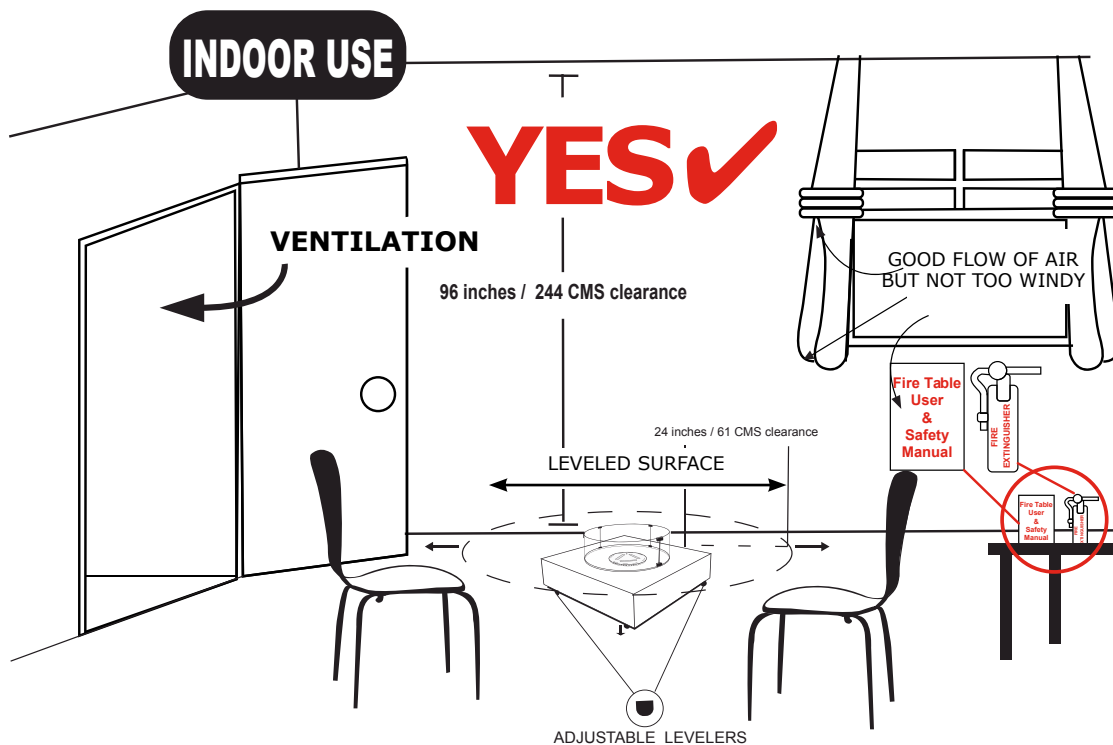

IMPROPER INSTALLATION AND POSITION OF THE FIRE TABLE



INGOT FIRE MANUFACTURER | USER INSTRUCTIONS

PROPER INSTALLATION AND POSITION OF THE FIRE PEDESTAL

OUTDOOR USE



IMPROPER INSTALLATION AND POSITION OF THE FIRE PEDESTAL

OUTDOOR USE



INGOT FIRE MANUFACTURER | USER INSTRUCTIONS

PROPER INSTALLATION AND POSITION OF THE FIRE TABLE

OUTDOOR USE



IMPROPER INSTALLATION AND POSITION OF THE FIRE TABLE

OUTDOOR USE

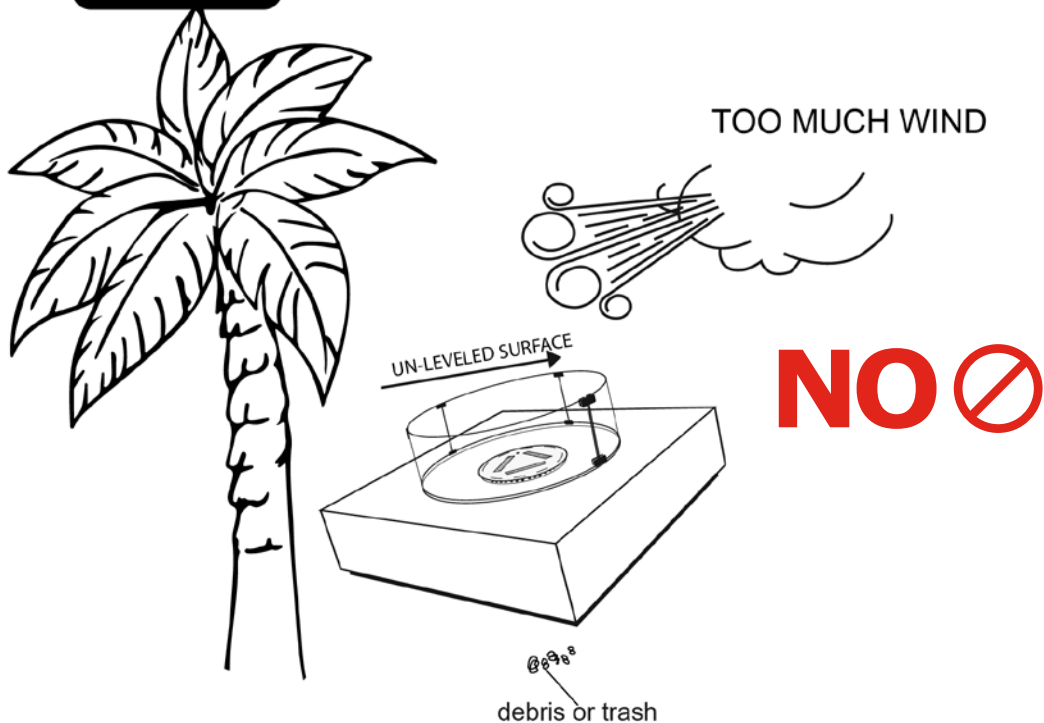

2

ASSEMBLY AND WARNINGS

- a** The fire tables and pedestals are equipped with levelers, use these to adjust on uneven surfaces. We recommend that you use a bubble level measure to make sure the unit is level.

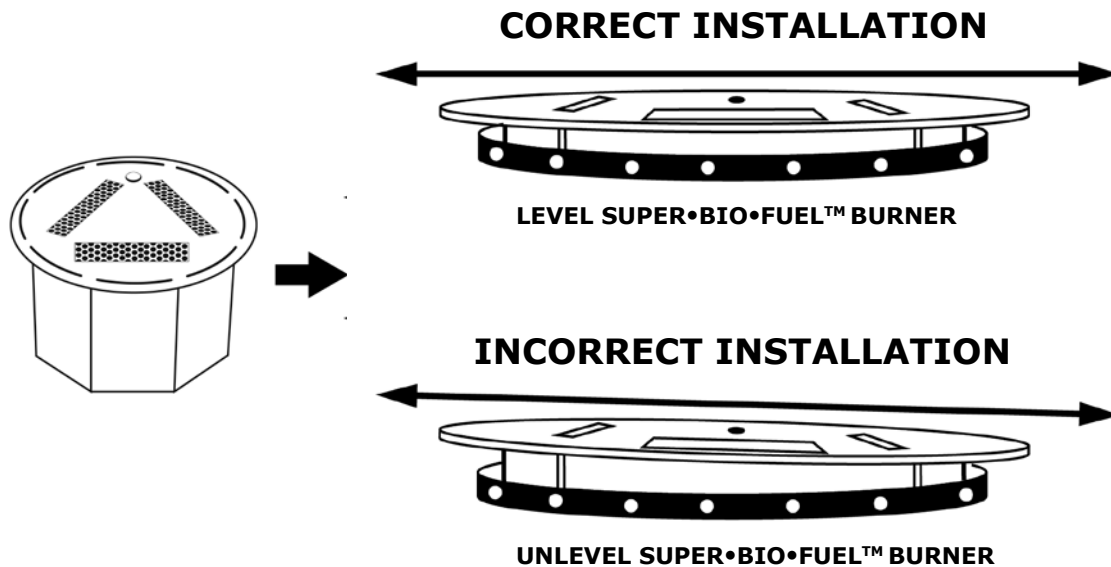

- b** When locating the Fire Table or Pedestal, ensure it sits on a level surface free of any debris and with proper clearances. ONLY then, insert the burner into the cut out hole of the fire table or pedestal. Make certain the burner is correctly inserted and is perfectly level inside the fire table or pedestal and that the fire/wind guard is in place. Use of levelers on the bottom of Pedestals and or Tables should be used to ensure proper leveling of the burner tables and/or pedestals at all times.

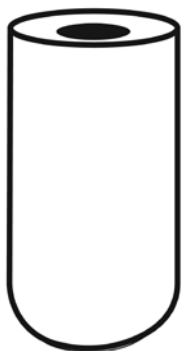

NO



YES

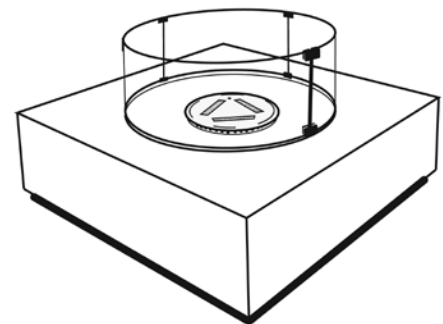

YES

2

ASSEMBLY AND WARNINGS

In your package you will find 4 pieces of radius cut tempered glass and 8 aluminum alloy clips to assemble the Wind | Fire Guard.

- c** Carefully check for any chips, cracks or any type of damage to the tempered glass panels (4 glass panels).

If there is any damage report this to the selling Dealer immediately



YES ✓



NO ✗



- d** Follow instructions for assembly in this box to ensure correct assembly.



- e** Pay close attention to the HOT Warning message etched into the glass, this Warning message should all be located at the bottom of the Wind | Fire Guard once it is fully assembled.

- f** Make certain that the rubber clips installed on the bottom are all facing in the same direction (4 clips with rubber feet will make contact with surface of the table or pedestal)

- g** Place the assembled round Wind | Fire Guard directly over the burner well BUT make sure that the guard sits on the outer edge/surface of the fire table or fire pedestal. See schematic.

INGOT FIRE MANUFACTURER | USER INSTRUCTIONS

2

ASSEMBLY AND WARNINGS

h Assemble the round Wind/Fire Guard as shown.

Check that you have the **correct sized** tempered Glass Fire Guard/Wind Shield for the size of your fire table or fire pedestal.

When fully assembled, a Seasonal Living Wind/Fire Guard for Fire Table will measure (28 Inches or 71.12 CMS Diameter) or Fire Pedestal will measure (14 Inches or 35.56 CMS Diameter).

DO NOT attempt to use the wrong sized tempered glass Wind/Fire Guard with fire table or fire pedestal.

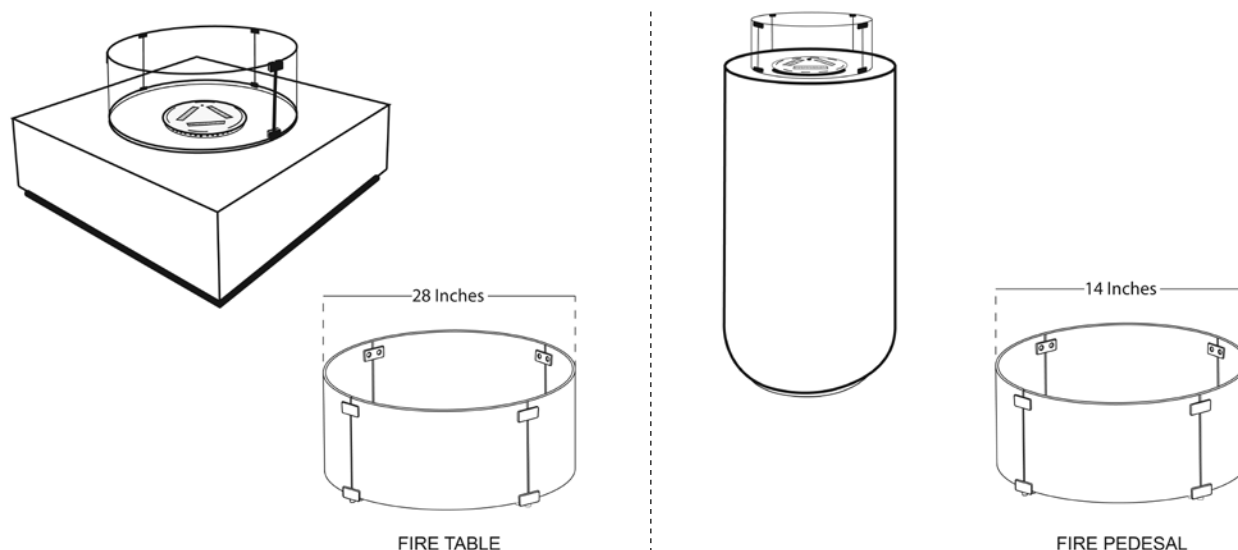

i Make sure the Wind/Fire Guard is fully stable and correctly assembled and secure before using it. If you break any glass panels, contact the Dealer for a replacement. **DO NOT OPERATE ANY OF THESE FIRES** without using the fully assembled (and in place) glass Wind/Fire Guard

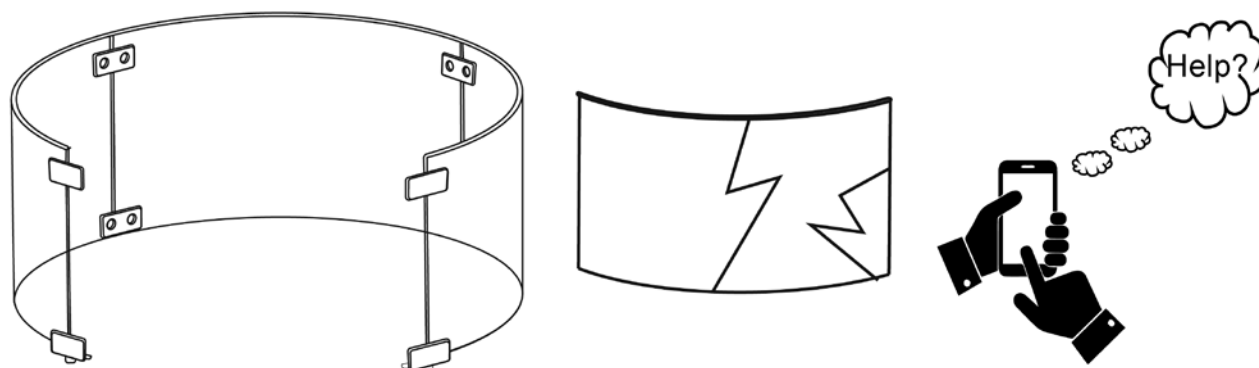

j If you damage or any part of the Wind/Fire Guard is broken or damaged, **DO NOT operate the fire table or fire pedestal.** Call your dealer for assistance to replace the guard.

INGOT FIRE MANUFACTURER | USER INSTRUCTIONS

2

ASSEMBLY AND WARNINGS

- k** Make sure it is level. Make sure that the feet on the base of the Wind/Fire Guard are all installed in proper direction to ensure correct contact with the fire table/fire pedestal surface at 4 points.

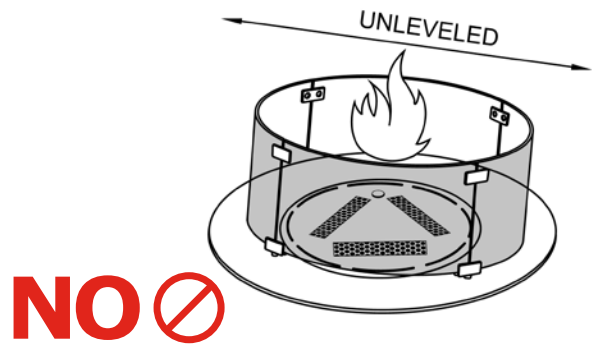
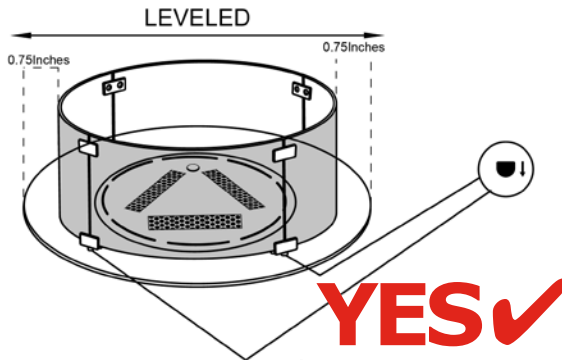

- l** The Wind/Fire Guard is designed to sit on the surface of the of the Fire Table or Pedestal (no attachment is necessary), make certain there is an equal clearance on all sides, approximately 0.75 Inches/1.90CMS for Fire Tables and 0.75 Inches/1.90CMS for Fire Pedestals.

DO NOT OPERATE OR LIGHT THE FIRE if the Wind | Fire Guard is not level or does not sit evenly on the fire table or the fire pedestal.

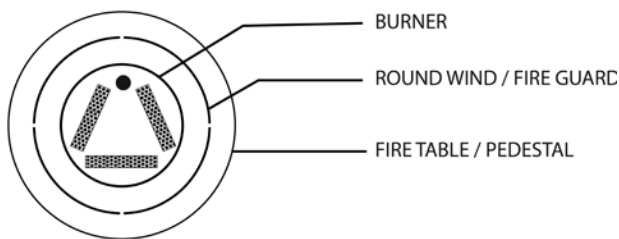

NEVER touch the protective Wind | Fire Guard, while fire burner is in operation. The Wind | Fire Guard is HOT to the touch and may cause burns or more severe accidents

- Keep all other items away from the Wind/Fire Guard while the fire is in operation.
- The Wind/Fire Guard is not a foot rest, or a foot warmer, do not place any type of pillows or any type of material on top of the Wind/Fire Guard or on top of the fire table.

- Keep children and Pets away from **HOT** Glass



YES ✓



NO ✗



- m** Warning! DO NOT assemble OR operate fire if any part of the Wind | Fire Guard or Wind Shield Is cracked, chipped or damaged in any way. Call your Dealer for assistance with replacements

INGOT FIRE MANUFACTURER | USER INSTRUCTIONS

3 FUELING | LIGHTING BURNER



YES ✓

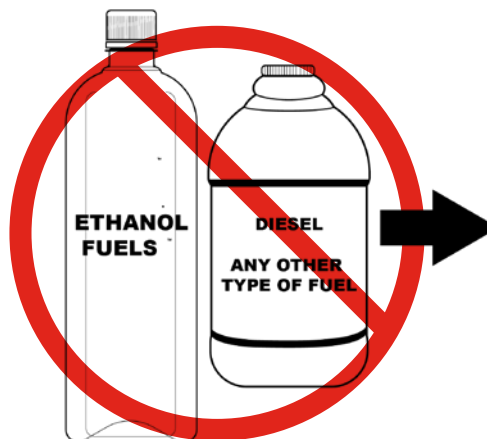

NO ✗



Open carton box(s) containing the Super.Bio.Fuel and SBF Starter Fluid. Check contents/ counts. Read below to learn how to re-order Super.Bio.Fuel and SBF Starter fluid)

NEVER OPERATE this Fire Table or Fire Pedestal with any other fuel except Super.Bio.Fuel and the SBF Starter Fluid (**NEVER USE ANY OTHER BRAND OF FUEL AND NEVER USE ETHANOL FUELS**). **Doing so is highly dangerous and can lead to: severe fires, loss of property, burns and or death.**

If fuels other than Super.Bio.Fuel and SBF Starter Fluid are used, the Manufacturer Warranty is void.

READ ALL INSTRUCTIONS on how to properly use Super.Bio.Fuel and SBF Starter Fluid BEFORE FILLING FUEL TANK.

ONLY USE FUEL PORT for fuelling with Super.Bio.Fuel.

DO NOT pour SBF Starter Fluid INTO the fuel port.

Refer to the Safety Data Sheet (SDS) for the Super.Bio.Fuel (pages 5-8) and the SBF Starter Fluid on pages 9-12.

**You can order more Super.Bio.Fuel by visiting this website page:
bit.ly/sbf-ordering (case sensitive)**

INGOT FIRE MANUFACTURER | USER INSTRUCTIONS

3 FUELING | LIGHTING BURNER

- a** Check the volume of fuel for your particular burner will hold.

(The AR8 Burner fuel capacity is: 101 Fluid Ounces | 3.0 Liters = for fire pedestals.

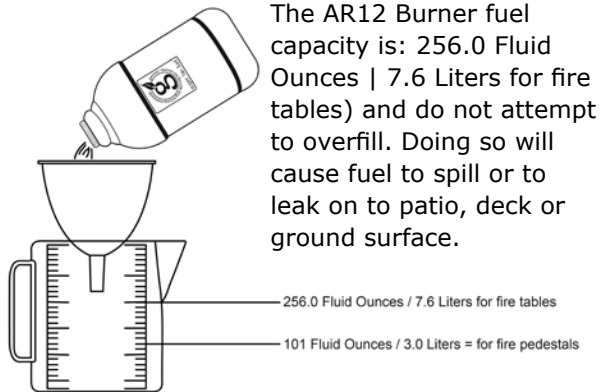

- b** Using a plastic fuel funnel, slowly pour SUPER.BIO.FUEL from its fuel bottle into the funnel inserted into the fuel port of the burner, taking care not to overfill the fuel funnel.

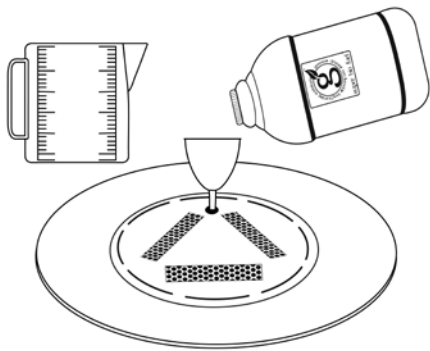

WARNING! DO NOT pour SBF Starter Fluid INTO the fuel port.

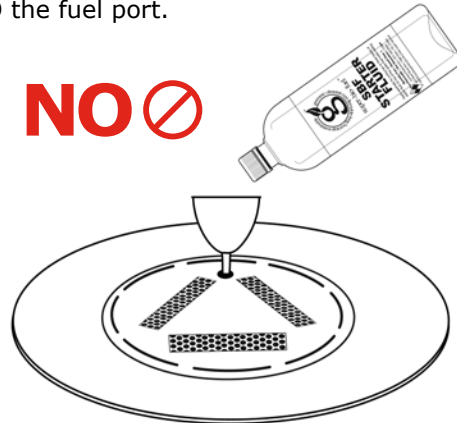

- d** REMOVE THE FUEL FUNNEL AND REPLACE THE FUEL PORT CAP PRIOR TO LIGHTING

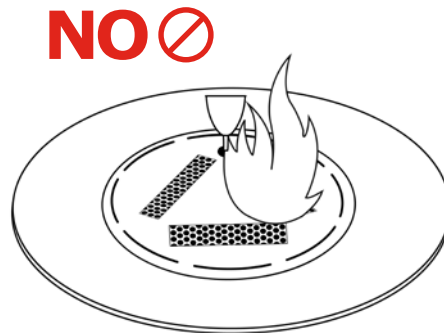

IMPORTANT! DO NOT OVERFILL THE FUEL TANK over filling can cause fuel to spill over ground surface.

- c** Should the fuel overflow from the burner, wipe up any excess with a paper towel and discard in an outdoor trash receptacle prior to lighting. The fuel is not toxic but will not evaporate and therefore must be wiped up.

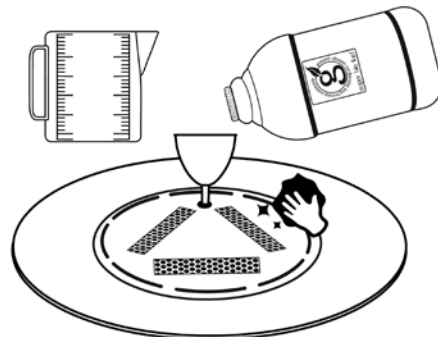
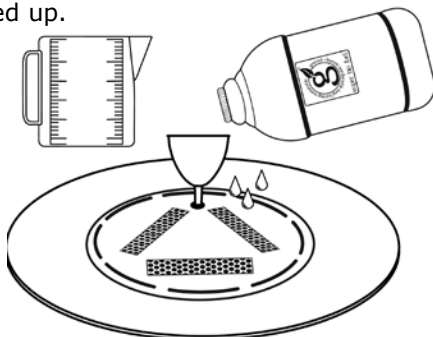

INGOT FIRE MANUFACTURER | USER INSTRUCTIONS

3 FUELING | LIGHTING BURNER

INITIAL FUELING ONLY - For initial fueling, it is imperative to completely saturate the fiberglass wick which is inside each of the perforated steel cages. This is referred to as *CONDITIONING THE WICK* and is only necessary on the initial fill or if your wick has become dry due to non use. To do this, follow these instructions:

e Check the volume of fuel your particular burner will hold.

(The AR8 Burner fuel capacity is: 101 Fluid Ounces / 3.0 Liters = for fire pedestals.

The AR12 Burner fuel capacity is: 256.0 Fluid Ounces / 7.6 Liters for fire tables) and do not attempt to overfill. Doing so will cause fuel to spill or to leak on to patio, deck or ground surface.

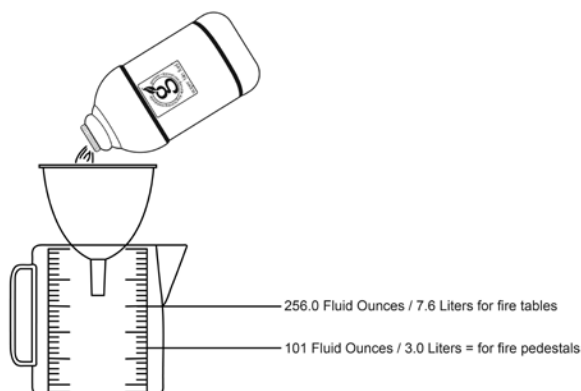

f Replace the fuel port cap after fueling ensuring it is firmly in place.

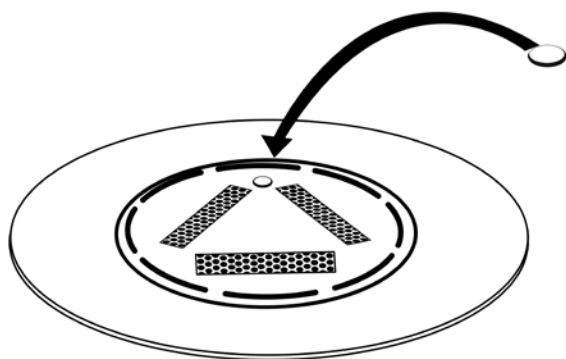

SUPER.BIO.FUEL

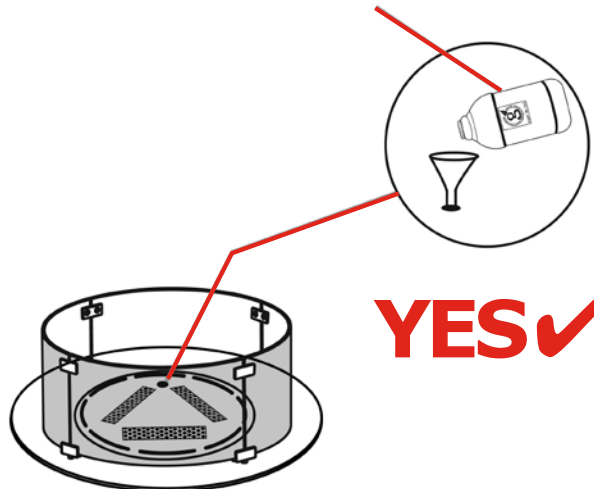

DO NOT pour SBF Starter Fluid INTO the fuel port.

SBF STARTER FLUID

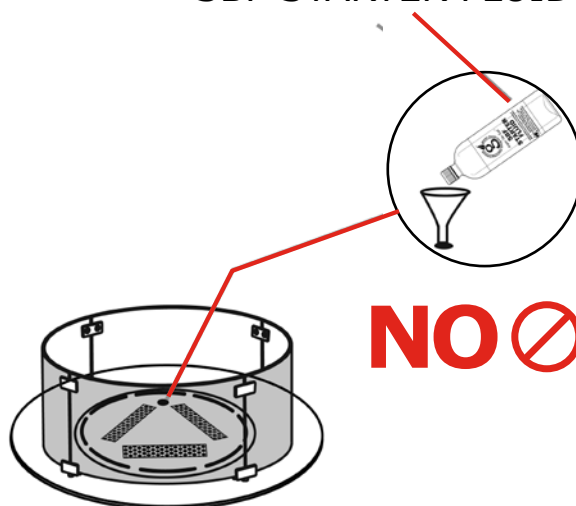

INGOT FIRE MANUFACTURER | USER INSTRUCTIONS

3

FUELING | LIGHTING BURNER

- g** Remove the plastic fuel funnel from the fuel port prior to lighting the burner

NO 

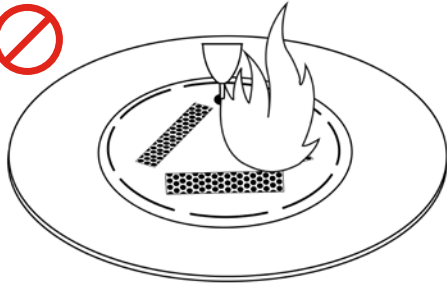

- h** Once the burner is full, let it sit for 10-15 minutes before lighting fire to allow the wick to absorb the fuel. Then top off the fuel again, let it sit for an additional 10 minutes

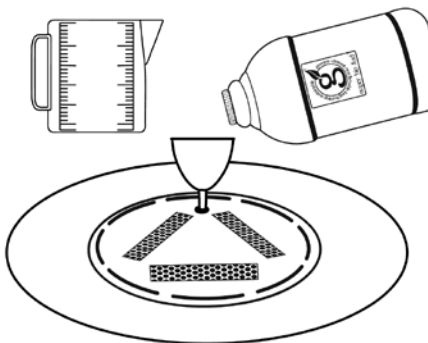
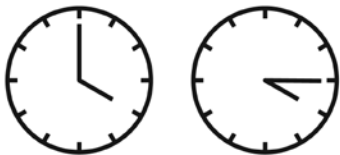
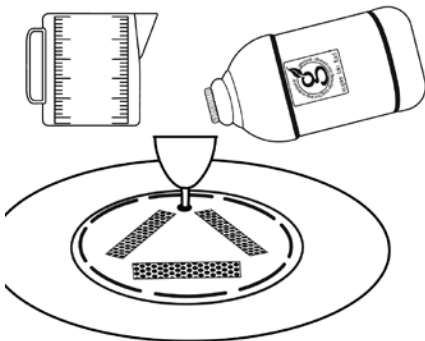

- i** After conditioning the wick (as previously described) squeeze a thin bead of SBF Starter Fluid on to the top of each fire grate. DO NOT SATURATE. Light burner grates immediately.

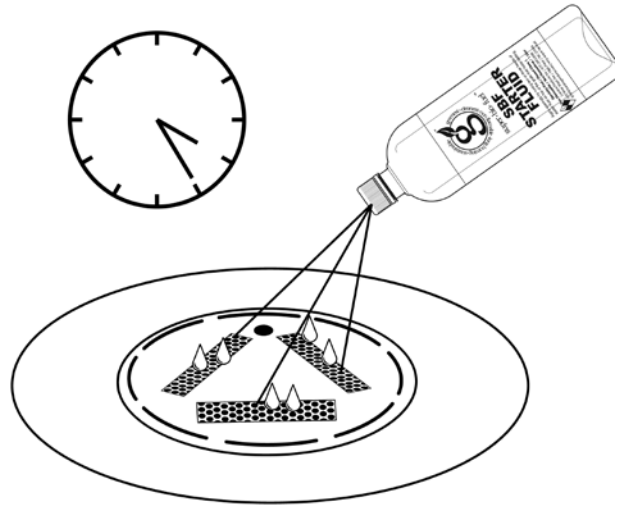

- j** Prepare to light the fire.

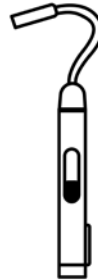

YES 

NO 

INGOT FIRE MANUFACTURER | USER INSTRUCTIONS

3 FUELING | LIGHTING BURNER

How to Light your Super.Bio.Fuel Burner

Use **ONLY SUPER.BIO.FUEL & SBF Starter Fluid**. **DO NOT USE ANY OTHER FUEL**. Failure to use the right fuel and fill the burner properly can result in damage to its operation. Follow the instructions: ONLY use a long handled 'BBQ gas lighter' (common kitchen style candle or kitchen lighter available from grocery or hardware store).

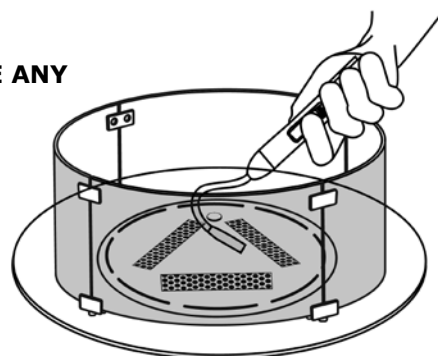

k Immediately light the SBF Starter Fluid beads on top of each fire grate. This should ignite easily. **NOTE: ONLY Add SBF Starter Fluid when you are ready to light the fire. DO NOT RE-APPLY SBF STARTER FLUID when flame is present or burner is warm.**

l The initial flames are small and low. Be patient, the flames will grow in size as the Super.Bio.Fuel heats up.

You will begin to see the flame form and draw the fuel through the wick and in about 8-10 minutes you should have full height flames.

Should the flame go out (during lighting phase only), wait 5 minutes, and repeat the process.

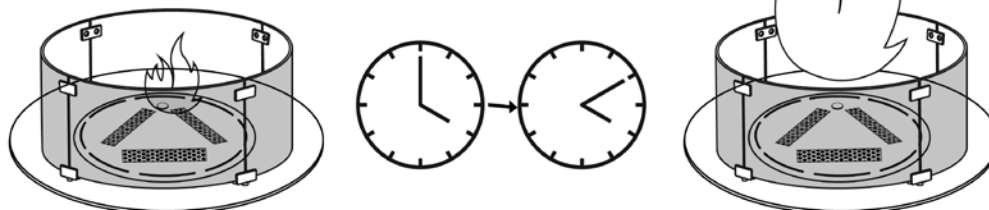

m Should the flame go out (during lighting phase only), wait 5 minutes, and repeat the process.

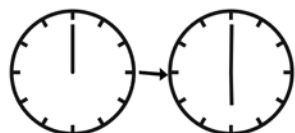
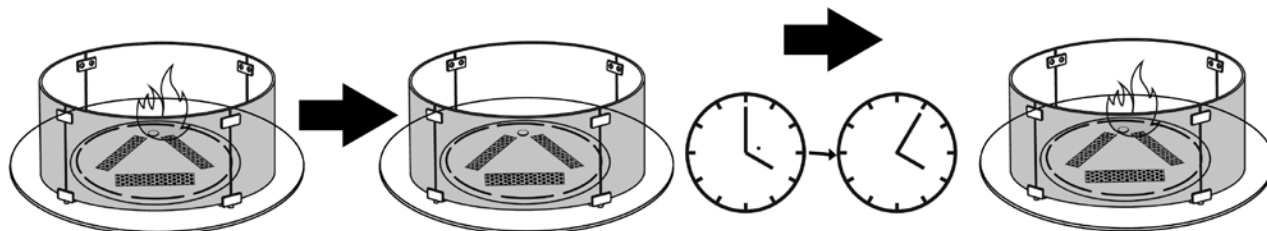

AR8 SBF Round Burner – for Fire Pedestals –
Approx. 6 Hours with a fully fueled burner.

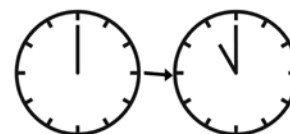

AR12 SBF Round Burner for Fire Tables –
Approx. 10-11 Hours with a fully fueled burner).

NOTE: Burn times will vary according to strength of wind. The stronger the wind, the more quickly the fuel will burn. **DO NOT OPERATE any Super.Bio.Fuel burner in strong winds.** Doing so is DANGEROUS.

INGOT FIRE MANUFACTURER | USER INSTRUCTIONS

3 FUELING | LIGHTING BURNER

NEVER touch the protective Wind | Fire Guard, while fire burner is in operation. The Wind | Fire Guard is HOT to the touch and may cause burns or more severe accidents.

Keep all other items away from the Wind/Fire Guard while the fire is in operation.

The Wind/Fire Guard is not a foot rest, or a foot warmer, do not place any type of pillows or any type of material on top of the Wind/Fire Guard or on top of the fire table.

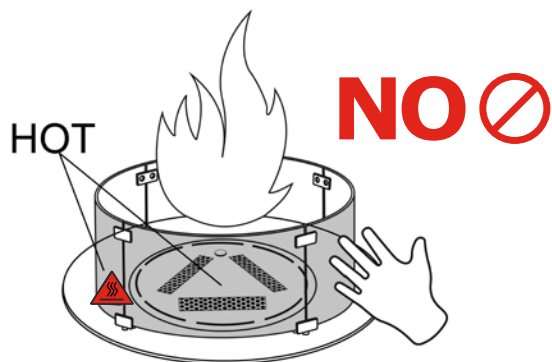

4 EXTINGUISHING THE BURNER

How to extinguish the burner

- a** Let the burner burn through all the fuel (see approx. burn times per the burner size on previous page).
- b** Using the supplied Burner Lid, approach the lit fire with caution and place it directly down over the flames. The lack of oxygen to the burner will extinguish the flames/fire. **DO NOT REMOVE THE LID.** The Burner Lid will be HOT

to the touch. Do not touch burner lid for at least 1 hour (60 minutes) after placing it on top of lit burner.

Note, there may appear to be smoke/steam after extinguishing the burner. This is simply the heat continuing to vaporize the fuel. This is not smoke, nor is it dangerous. It will subside in a few minutes. You may notice some moisture build up on the bottom of the lid. This can be wiped off with a paper towel AFTER 60 minutes of the burner cooling.

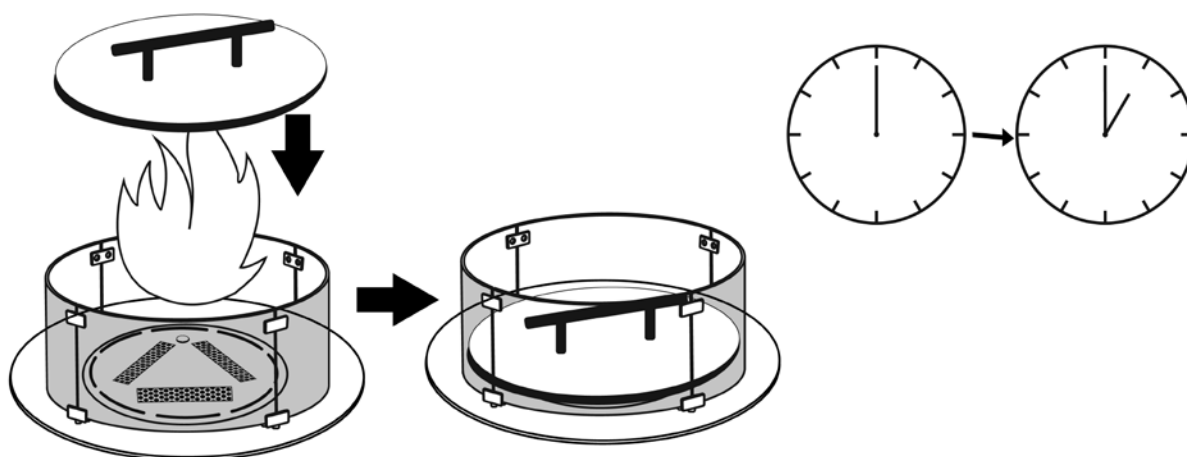

INGOT FIRE MANUFACTURER | USER INSTRUCTIONS

5 REFUELING THE BURNER

Refueling Burners – **NEVER REFUEL a HOT Burner.**

Doing so is DANGEROUS and can cause instant fire ignition, loss of property, severe burns and or death.

ALWAYS wait 30 minutes after a fire is extinguished BEFORE you ADD any more fuel to a hot, empty burner.

Review your Burner size and fuel the Burner according to previous instructions.

Never fuel the burner when in operation.

Never fuel the burner when it is hot.

Never fuel the burner except through the fuel port.

DO NOT pour SBF Starter Fluid INTO the fuel port.

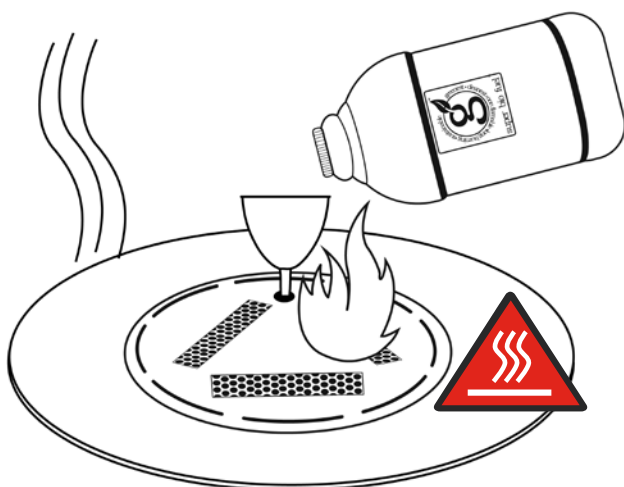

NO 

HOT

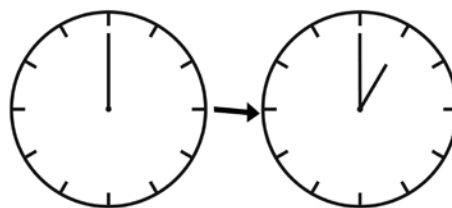

Always use the fuel funnel to ensure accuracy and no spills when filling of the reservoir.

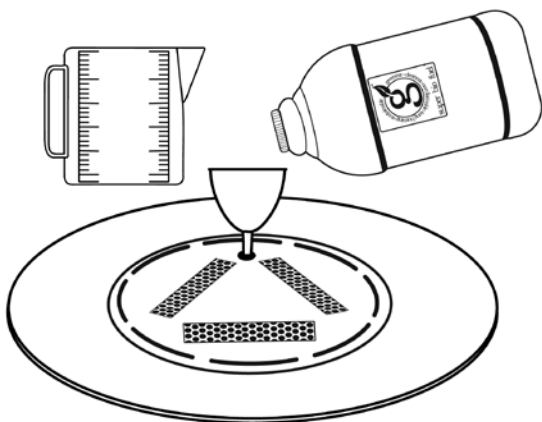

YES 

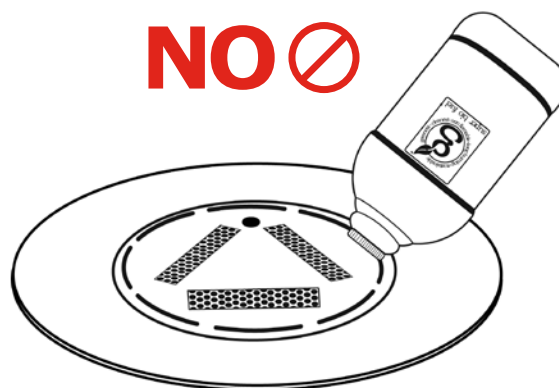

NO 

6

PROPER USE OF YOUR PURCHASE

Only use Fire Pedestal or Fire Tables in these conditions to ensure a safer experience.

Level surface

- No placement of a fire pedestal or fire table within 24 inches / 61 CMS of any type of building or wall).
- ONLY operate the Burner in calm weather conditions.
- DO NOT EXPOSE BURNER TO RAIN.
- Always keep Children and Pets away from burning fire table or fire pedestals.
- NO strong winds or extreme weather.
- ENSURE ALL RECOMMENDED CLEARANCES ARE MET PRIOR TO LIGHTING THE BURNER.
- PROCEED WITH CAUTION in determining where to locate or place any fire pedestal. Make sure that the fire pedestal cannot be easily blown over by strong winds. Do not place / locate in active or busy walkways. Place in sheltered, safe locations away from heavy human or pet / animal traffic
- NO sitting ON or right next to fire table or fire pedestals that could result in hair igniting, or any other related loose object.
- These products are solely for use as decorative fire pedestals or fire tables. DO NOT sit on, jump on / off, climb on to, stand on, play on or use these products as a step ladder at any time. Standing on or using the item not as intended is highly dangerous and will damage the product material and surfaces.
- Tables are not for climbing on. Never climb on top of any fire table or fire pedestal – this is dangerous and can result in severe injury.
- NO fabrics next to or hanging over fire table or pedestals.
- No Hanging plants or low tree branches over fire.
- No Cooking with use of the burner. The burner and the fire are NOT for cooking – Fuel will taint the flavor of the food. For ambiance use ONLY. Food of any type could enter the reservoir through the vents and permanently damage the operation of your burner.
- No standing close to or leaning over the fire as this could result in igniting a fire on your person.
- No placing hands over the fire as this could result in burning oneself

Fire is always to be supervised by a responsible adult.

Fire is only to be operated by a responsible adult, defined as:

A physically capable adult (over 18 years of age) who is not intoxicated or on any type of recreational drugs.

An ABC Fire Extinguisher is ALWAYS to be located in close proximity (or same room) as fire table or fire pedestal.

- NEVER permit children to operate any fire at any time. Children MUST always be supervised around fuel and when the fire is in operation. Failure to adequately supervise children can lead to severe bodily injury, death and or loss of property

6

PROPER USE OF YOUR PURCHASE

Only use Fire Pedestal or Fire Tables in these conditions to ensure a safer experience.

Level surface.

- DO NOT EXPOSE BURNER TO RAIN WATER. Prevent water from entering into and collecting inside the burner.
- No placement of a fire pedestal or fire table within 24 inches / 61 CMS of any type of wall or fabric barrier.
- Ensure all recommended clearances are met prior to lighting the burner.
- Well-ventilated room (window open, door open).
- Keep Children and Pets away from burning fire table or fire pedestals
- Locate fire table or fire pedestal in a location where it cannot be knocked over or tripped over.
- NO fabrics next to or hanging over fire table or pedestals.
- No uncontrolled party behaviour which could lead to misuse or a dangerous operation of a fire. Always warn guests of the importance of common sense behaviour nearby an operating fire
- No Food Cooking of any type with use of these burners.
- No standing close to fire.
- No placing hands over fire.
- Fire always to be supervised by a responsible adult.
- Fire always to be extinguished by a responsible adult.
- An adult who is intoxicated by alcohol or who has consumed any type of recreational drug(s) MUST NOT fuel, operate or extinguish any fire.
- DO NOT operate any burner/fire table or pedestal when intoxicated.
- Have an ABC fire Extinguisher in SAME Room or SAME location as the fire table or fire pedestal and understand how to operate the fire extinguisher.

WARNING! DO NOT climb on, stand on, jump on / off any fire table and or fire pedestal. These items are not designed for this type of use. Failure to follow these instructions can lead to serious injury, loss of property and or Death

INGOT FIRE MANUFACTURER | USER INSTRUCTIONS

PROPER INSTALLATION AND POSITION OF THE FIRE TABLE

OUTDOOR USE

YES ✓

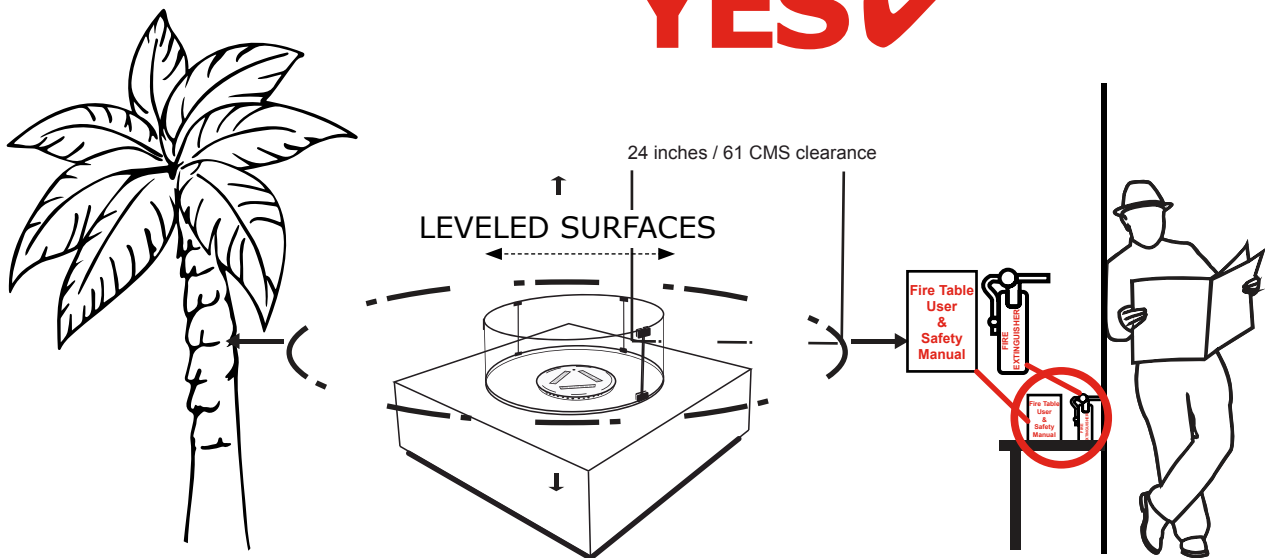

IMPROPER INSTALLATION AND POSITION OF THE FIRE TABLE

OUTDOOR USE

NO 



INGOT FIRE MANUFACTURER | USER INSTRUCTIONS

PROPER INSTALLATION AND POSITION OF THE FIRE TABLE

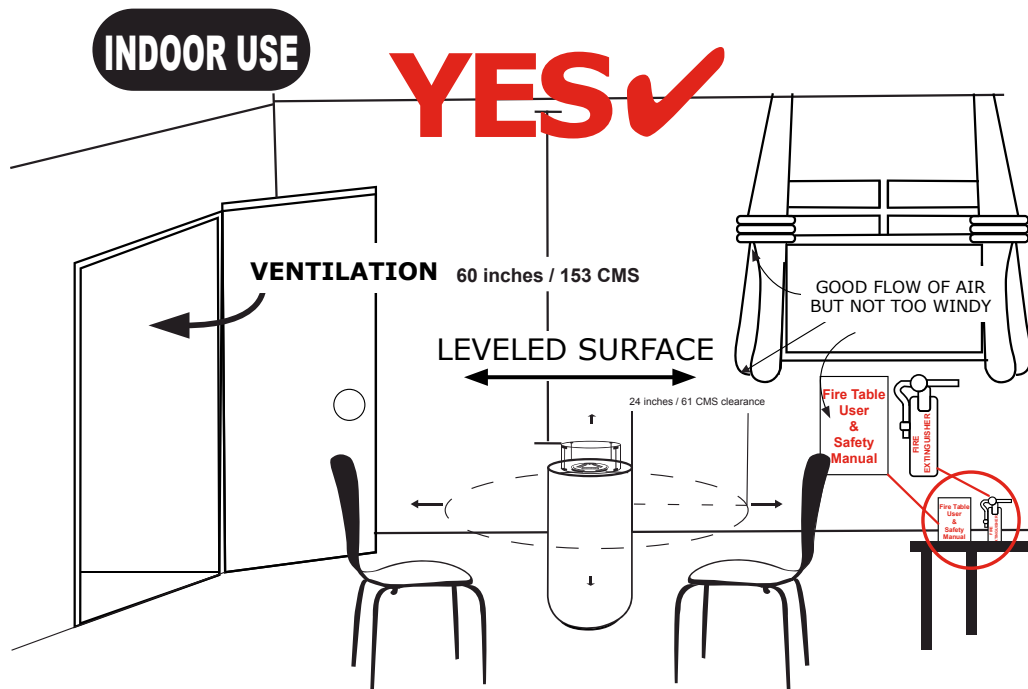

IMPROPER INSTALLATION AND POSITION OF THE FIRE TABLE



PROPER INSTALLATION AND POSITION OF THE FIRE TABLE

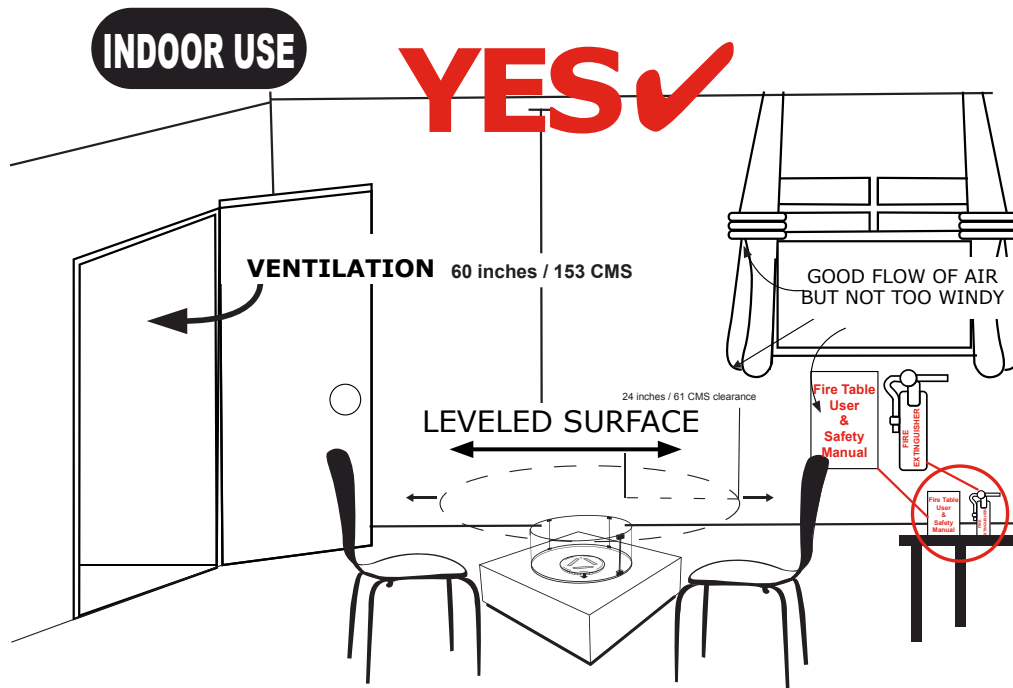

IMPROPER INSTALLATION AND POSITION OF THE FIRE TABLE

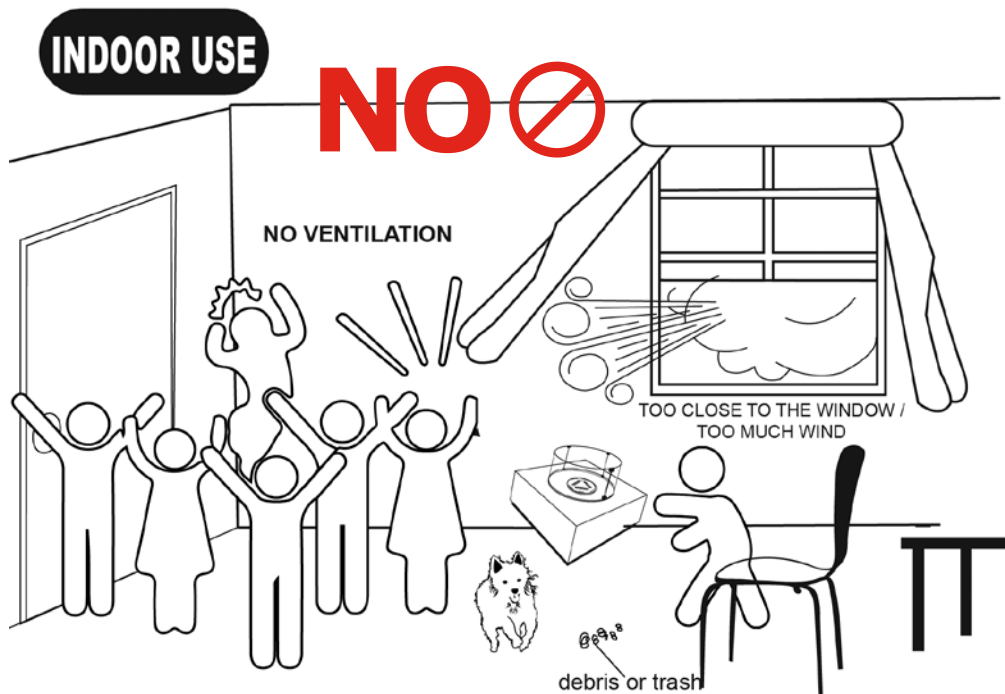

INGOT FIRE MANUFACTURER | USER INSTRUCTIONS

7

CARING | STORING YOUR PURCHASE

How to Care for your Super.Bio.Fuel Burner

- a** Remove burner when not in use.
- b** Store the empty burner in a safe, cool covered location (for example an outside shed or garage is ideal), away from easy access by children.

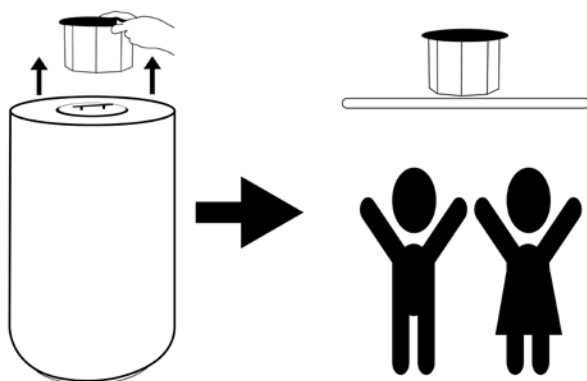

- c** Place fire burner lid over empty fire table burner hole.

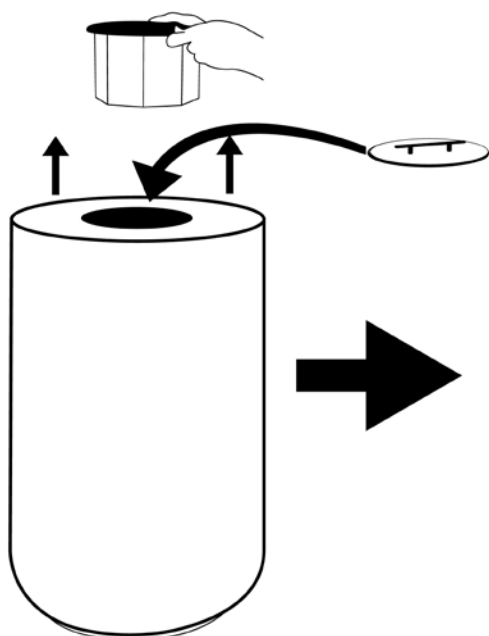

- d** Once a month (or when visibly scorched), empty fire burner and clean the exterior of the burner. We recommend you use: CARON & DOUCET - BBQ Cleaner Oil, (available on www.Amazon.com). This is a heavy-duty metal cleaner with the perfect combination of cleaning solution and abrasives to tackle the toughest stainless scorching and discoloration on stainless steel burners.

BENEFIT: One-step cleaner/polisher saves time.

SPECIAL INSTRUCTIONS: Just rub in the same direction of the grain of the stainless steel.

DO NOT USE OTHER ABRASIVES OR ANY ABRASIVE CLOTH (Steel wool, etc.)

Always make certain that the cavity of the burner is free of all debris before refueling.

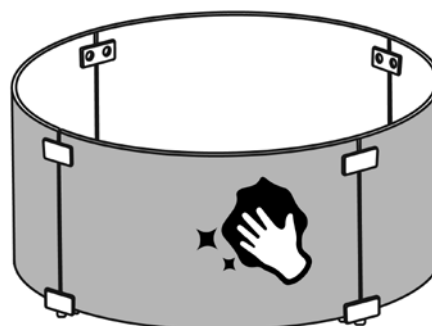

INGOT FIRE MANUFACTURER | USER INSTRUCTIONS

7 CARING | STORING YOUR PURCHASE

How to care for your Tempered Glass Fire Guard

- e** When the Wind | Fire Guard is cool/cold to the touch, use Windex or other similar glass cleaners and a paper towel.
- f** When not using the fire, store the assembled Wind | Fire Guard away in a safe location, where it cannot be damaged.
- g** **ALWAYS** recheck the Tempered Wind/Fire Guard for any damage before re-starting any Super.Bio.Fuel Fire product

YES ✓

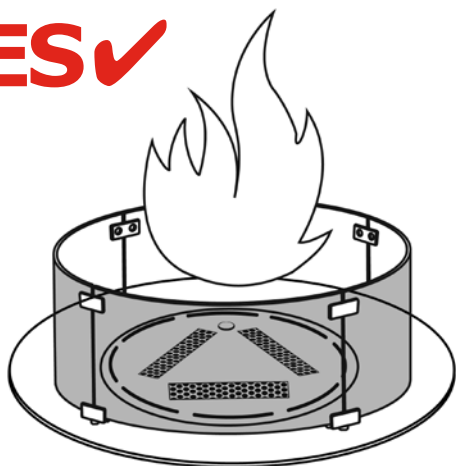

DO NOT operate the burner IF any part of the Wind | Fire Guard is in any way damaged.

NO ✗

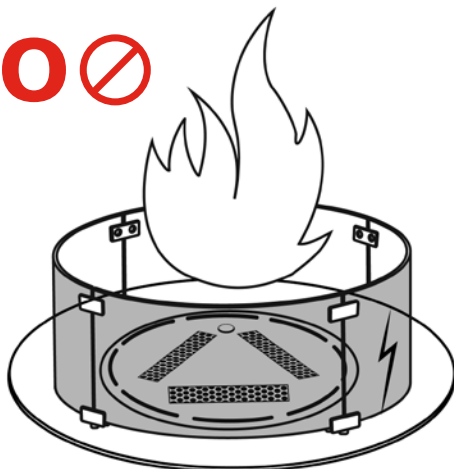

How to safely store Super.Bio.Fuel and SBF Starter Fluid

ALWAYS make sure that ALL fuel is ALWAYS locked away in a location not accessible to any children.

Store Super.Bio.Fuel and Super.Bio.Fuel Starter fluid in a cool place away from any heat sources.

Never store SBF and SBF Starter Fluid in the cavity of the fire table or fire pedestal, doing so could easily result in spillage and cause a fire. Always store in proper location out of the way of the burners and children.

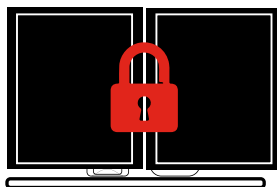

YES ✓



NO ✗

- h** Store Super.Bio.Fuel and SBF Starter fluid in a cool place away from any heat sources.



INGOT FIRE MANUFACTURER | USER INSTRUCTIONS

7 CARING | STORING YOUR PURCHASE

Use Fire Table, Fire Pedestal Covers when not in use

Always allow the burner to cool 60 minutes before placing cover on the table or pedestal.

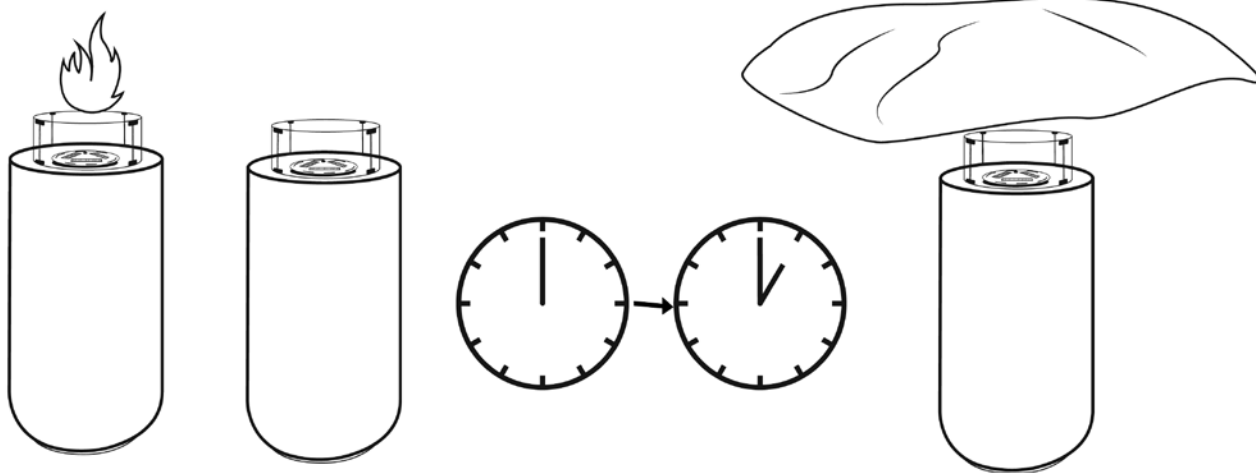

Cover the table/pedestal against weather, and moisture when not in use.

DON'T EXPOSE BURNER TO RAIN WATER. DO NOT PERMIT WATER TO ENTER INSIDE BURER.



When storing cover, always store away from the fire table and fire pedestal.

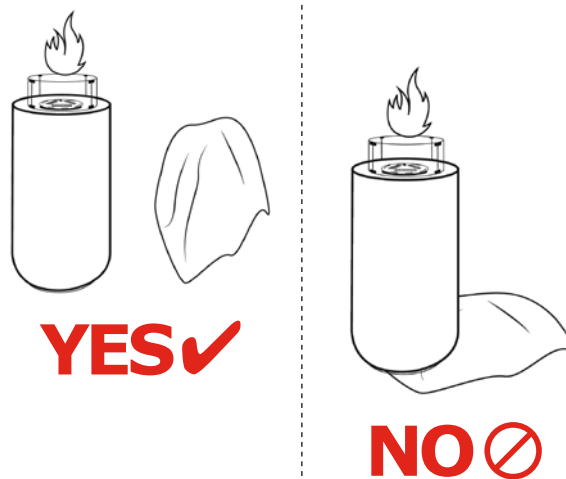

Never store any item directly on top of the surface, of any Ingot Product. Doing so could easily scratch, dent, puncture, or compromise the sealant that is applied to protect the finish.

INGOT FIRE MANUFACTURER | USER INSTRUCTIONS

8 ORDERING INFORMATION

WE RECOMMEND THAT YOU ORDER THE FOLLOWING PROTECTION PRODUCTS:

ABC FIRE EXTINGUISHER

Make sure your house, garage and workshop are prepared for potential fires by acquiring an ABC Fire Extinguisher (Available from Home Depot® or other Hardware Stores). This fire extinguisher is suitable for use on fire involving household materials, including fabrics, plastics, wood, paper, flammable liquids and electrical equipment. Make sure you are highly familiar with the operation of the fire extinguisher.

ADDITIONAL ITEMS THAT YOU NEED TO PURCHASE TO OPERATE THE SUPER•BIO•FUEL™ BURNER:

A long-stemmed, high-powered, flexible, Butane BBQ or Kitchen lighter

HOW TO ORDER

YOU CAN ORDER FUEL BY VISITING THIS WEBSITE PAGE:

bit.ly/sbf-ordering (case sensitive)

12 Pack Includes:

1 x 1.0 Liter SBF STARTER FLUID Bottle
11 x 1.0 Liter SUPER.BIO.FUEL™ Bottles



12 Pack (11+1)

TERMS OF SALE FOR ALL FUEL PURCHASES:

- All Sales final
- No Returns
- No Exchanges
- No split cartons
- The fuel is only available in 12 liter packs consisting of 11 liter bottles of Super.Bio.Fuel and 1 liter bottle of SBF Starter Fluid

IMPORTANT!
SEASONAL LIVING DOES NOT STOCK AND/OR SELL ANY TYPE OF FUEL TO OPERATE ANY FIRES IN THIS COLLECTION



Fire Extinguisher Not Included

Images are not to scale.

HOW TO RE-ORDER REPLACEMENT INGOT FIRE WICKS

Should you need to replace (or order) the Ingot Fire Wick, please contact the original store or design specifier from whom you purchased this product.

9 WARRANTY INFORMATION

INGOT HAND HAMMERED METAL COLLECTION LIMITED MANUFACTURER'S WARRANTY

AUGUST 2021

WE STRONGLY RECOMMEND USE OF HIGH QUALITY, BREATHABLE FURNITURE COVERS

WHAT IS COVERED: Seasonal Living warrants its INGOT Metal Collection to be free from manufacturing structural defects for a period of three (3) years from date of original purchase from the direct manufacturer. Seasonal Living will repair or replace (at its option) any product, part, or component covered by this Limited Warranty, which fails under normal use and correct product maintenance as a result of a defect in material or workmanship. Seasonal Living will repair or replace the aforementioned product, part, or component with a comparable product, part, or component. This Limited Warranty extends only to the original purchaser (original Seasonal Living invoice customers only) who acquires the product in new, original condition (un-used condition) from Seasonal Living dealer. Any product, part, or component must have been installed, used and maintained in accordance with the written Product Care Instructions and any other instructions, warranties or warnings provided by Seasonal Living, if any, included with the product or otherwise provided to the original purchaser. This Limited Warranty covers defects in materials and manufacturing only; it does not include normal wear and tear, misuse, abuse of product, damage caused by lack of proper care, including storage in off season, installation and or maintenance or using the product in a manner for which it was not designed. **Any modification to the original product voids this Limited Warranty.** If within three (3) years of the date of purchase (from Seasonal Living), the Product is found to be defective due to quality of craftsmanship, a written claim must be immediately filed to the dealer accompanied with proof of purchase along with where this product was purchased from with supporting photographic evidence and a detailed written description with dates detailing when defects were first encountered along with original purchase invoice.



WARNING! Tables and Chairs/Stools must NEVER be used to be climbed on to, no standing on, no jumping on or off any table or chair. Do not use tables or chairs as step ladders, they are not designed for this purpose. Chairs or stools are ONLY designed to support the weight of one average person at a time. Do not allow MORE than 1 person to sit on the same chair or stool at any one time. All chairs and stools MUST remain fully in contact with a level ground surface at ALL TIMES. Make certain the "Levelers" located on the bottom of each table or pedestal (at the corners) are in place and used to maintain the piece on an actual level surface. DO NOT permit any child to play on or under any furniture at any time.

FAILURE TO FOLLOW THIS WARNING, MAY LEAD TO: DAMAGE OR LOSS OF PROPERTY, SEVERE BODILY INJURY AND IN SOME CASES DEATH.

SEASONAL LIVING DOES NOT PROVIDE ANY WARRANTY AGAINST:

- Failure to closely follow Seasonal Living's Product Care Instructions, Operating Instructions or warnings.
- Damage to the product in the course of shipment. Shipping damages MUST be notified on the original Bill of Lading and reported to the Manufacturer within 48 hours. Failure to inspect merchandise within the defined period will constitute as a waiver of any claim. Shipment-damage claims are not a manufacturer's defect.
- Shipping (and any other related freight charges), packing and any handling charges—shipping damaged product to our warehouse facility and for shipping replacements from our warehouse facility to desired delivery address requires that a claim with the shipper be filed.
- Natural variations in the surface grain, color or texture, or the presence of character marks. As this is a handmade product, you can expect some color variation in production lots.

9

WARRANTY INFORMATION

- Fuel related issues. Seasonal Living does not sell Warrant or provide any other claims of usability for any Super.Bio.Fuel purchased. All fuel purchases are strictly between the customer and the the fuel manufacturer and/or distributor.
- Changes in the surface finish due to aging or exposure to light
- Any damage or failure caused by outdoor use of a product not specifically designed and sold for outdoor use
- Any damage or failure caused by improper use of the product or use of the product in a manner that it was not intended e.g. table tops must be used in the manner that they are intended and not be used for sitting on or standing upon. Likewise, chairs should only be used for sitting upon. Leaning back on two chair legs is considered hazardous and damages arising from such use are not covered. Do not climb on to, jump (on / off) or stand on any furniture. **DO NOT PERMIT CHILDREN TO CLIMB ON, JUMP ON, STAND ON AND OR PLAY ON OR UNDERNEATH ANY FURNITURE—THIS IS DANGEROUS, AND CAN RESULT IN SERIOUS ACCIDENTS. DO NOT PERMIT CHILDREN TO PLAY IN, ON, UNDER OR WITH ANY TYPE FURNITURE PACKAGING. FAILURE TO CLOSELY MONITOR CHILDREN CAN LEAD TO: SEVERE PHYSICAL INJURY, SUFFOCATION AND OR DEATH.**
- Failure to set up or install the product as described by the manufacturer. If you are uncertain about this, e-mail us at Sales@SeasonalLiving.com
- Corrosion and or changes in the patina/outer surface originating from scratches
- Any damage or failure resulting from improper storage
- Failure resulting from normal wear and tear
- Misuse or abuse of the product
- Pitting, spot rusting or rusting on any Metal frame or assembly device as a result of use near (or in) a salt-water swimming pool, salt water sea or ocean
- Damage in shipping, failure to follow instructions, unauthorized repair or alterations
- Failure to wipe up spills and or water as described in the Product Care Instructions.
- Failure to correctly use suitable product furniture covers as recommended by Seasonal Living so as to protect the furniture when not in use.
- We recommend that you cover and protect your furniture and decorative accessories (when not in use) by purchasing and regularly using high quality, breathable furniture covers.
- The matching of colors, grains, or textures in natural and or handmade materials
- Damage from sharp objects or imprinting from writing instruments – DO NOT write directly on to any of the Ingot metal surface. ALWAYS use a soft pad below any stationery or writing materials.
- Damage from failure to use mats or pads to protect the furniture or decorative items from hot pots or pans
- Damage from customer dropping or placing furniture in a location that causes furniture or decorative accessories to be blown over or to fall or be knocked over either due to traffic (human, animal or mechanical) or extreme weather including but not limited to strong winds. Customer must use common sense and place merchandise in a location that will protect it and ensure complete level and stability.
- Incorrect use of cleaning products. Read the Product Care Instructions. Any deviation from this care voids the warranty.
- Any Acts of God/Nature, fire and extreme weather conditions
- Any additional parts purchased that do not accompany this product at the time of shipment and are not defined in the product’s description.
- Discoloration or fading as a result of chemical spills.
- Seasonal Living DOES NOT Warrant that any fuel supplied by any other third party will always be available.

9

WARRANTY INFORMATION

INSPECTION OF YOUR PRODUCTS

You are required to inspect your Products when you take delivery of them. If the packaging is removed or damaged on delivery then you will be required to note on the Original Bill of Lading any damage that is presented to you by the carrier for signature—FAILURE TO DO SO, VOIDS ANY CLAIM YOU MAY HAVE. You are required to contact us in writing within 48 business hours of receipt of the merchandise for any concealed damage; providing us with complete detailed photos and a clear and precise written description of all damages. We will not be liable for any damage to any of the Product(s) unless we are notified within the time periods specified above.

TO ENSURE THAT THE LIMITED WARRANTY IS VALID, CUSTOMER MUST PROVIDE CLEAR PHOTOGRAPHIC AND WRITTEN DESCRIPTIONS/EVIDENCE OF FAULTY PRODUCT AND BE PREPARED TO PRESENT ALL FAULTY MERCHANDISE OR SAMPLES TO SEASONAL LIVING. FOR EACH CLAIMED ITEM, AT LEAST 2 CLEAR LARGE PHOTOS MUST BE SUBMITTED, ONE WHICH SHOWS THE COMPLETE PIECE OF FURNITURE CLAIMED AND THE SECOND A CLOSE UP OF EVERY DAMAGED AREA.

SHOULD THE CUSTOMER CHOOSE NOT TO RETAIN DAMAGED MERCHANDISE, THEN THIS WARRANTY IS VOID.

ALL PRODUCTS SOLD BY SEASONAL LIVING ARE SOLD AS-IS, AND SEASONAL LIVING EXPRESSLY DISCLAIMS ALL WARRANTIES, WHETHER EXPRESSED OR IMPLIED BY LAW, COURSE OF DEALING, COURSE OF PERFORMANCE, USAGE OF TRADE OR OTHERWISE, INCLUDING, WITHOUT LIMITATION, ANY WARRANTY OF MERCHANTABILITY, WARRANTY OF FITNESS FOR A PARTICULAR PURPOSE, OR WARRANTY AGAINST INFRINGEMENT OF INTELLECTUAL PROPERTY RIGHTS OF A THIRD PARTY, EXCEPT TO THE EXTENT SUCH DISCLAIMER MAY BE LIMITED BY APPLICABLE LAW, IN WHICH CASE ANY SUCH WARRANTIES SHALL BE LIMITED TO THE DURATION OF THIS LIMITED WARRANTY. YOU AGREE AND AFFIRM THAT SEASONAL LIVING SHALL NOT BE LIABLE, UNDER ANY CIRCUMSTANCES, FOR ANY BREACH OF WARRANTY CLAIMS

OR FOR ANY DAMAGES ARISING OUT OF A MANUFACTURER'S FAILURE TO HONOR ITS WARRANTY OBLIGATIONS TO YOU. IT IS YOUR RESPONSIBILITY TO READ, UNDERSTAND AND FOLLOW ALL PRODUCT CARE, OPERATION, SAFETY AND WARRANTY INSTRUCTIONS. FAILURE TO ADHERE TO ALL PRODUCT INSTRUCTIONS MAY VOID ANY WARRANTY ASSOCIATED WITH SUCH PRODUCT.

LIMITATION OF LIABILITY

IN NO EVENT SHALL SEASONAL LIVING BE LIABLE TO YOU OR ANY THIRD PARTY FOR CONSEQUENTIAL, INDIRECT, INCIDENTAL, SPECIAL, EXEMPLARY, PUNITIVE OR ENHANCED DAMAGES, LOST PROFIT OR REVENUE OR DIMINUTION IN VALUE, ARISING OUT OF, OR RELATING TO, AND/OR IN CONNECTION WITH THE FURNISHING, PERFORMANCE, OR USE OF ANY GOODS OR SERVICES SOLD BY SEASONAL LIVING, INCLUDING PROPERTY DAMAGE, BODILY INJURY, OR DEATH, WHETHER DUE TO BREACH OF CONTRACT, BREACH OF WARRANTY, NEGLIGENCE, OR OTHERWISE, REGARDLESS OF (1) WHETHER SUCH DAMAGES WERE FORESEEABLE, (2) WHETHER OR NOT SEASONAL LIVING WAS ADVISED OF THE POSSIBILITY OF SUCH DAMAGES, OR (3) THE LEGAL OR EQUITABLE THEORY (CONTRACT, TORT OR OTHERWISE) UPON WHICH THE CLAIM IS BASED. SEASONAL LIVING'S SOLE OR ENTIRE MAXIMUM LIABILITY FOR ANY REASON, AND YOUR SOLE AND EXCLUSIVE REMEDY FOR ANY CAUSE WHATSOEVER, SHALL BE LIMITED TO THE ACTUAL AMOUNT PAID BY YOU FOR THE PRODUCTS AND SERVICES YOU HAVE ORDERED FROM SEASONAL LIVING. The foregoing limitation of liability shall only apply to the extent permitted by law.

Some States do not allow the exclusion or limitation of incidental or consequential damages, or limitations on how long an implied warranty lasts, so the above limitations or exclusions may not apply. In such cases, this Limited Warranty shall be deemed amended solely to the extent limited by such applicable State law. This Limited Warranty gives the purchaser specific legal rights and the purchaser

9

WARRANTY INFORMATION

may also have other rights, which vary from State to State

THIS LIMITED WARRANTY IS ONLY APPLICABLE TO CUSTOMERS WITHIN THE UNITED STATES OF AMERICA FOR PRODUCT USE WITHIN THE UNITED STATES.

CONTACT

By Post/Mail: Seasonal Living, Park Place 2, 4009 Bannister Lane, Suite 350, Austin, Texas 78704, United States of America.

By e-mail: Sales@SeasonalLiving.com

No other forms of communication are acceptable. We strongly recommend that any mailings by post/mail are by registered delivery either with the US Postal Service and or FedEx/UPS or other standard courier companies

PLEASE REMEMBER TO FOLLOW CARE INSTRUCTIONS—YOU CAN ALWAYS LOCATE THESE ON THE SEASONAL LIVING WEBSITE (www.SEASONALLIVING.COM) OR THROUGH YOUR DESIGNER OR RETAILER IF YOU LOSE THE PRODUCT CARE INSTRUCTIONS.

SEASONAL LIVING – LIMITED MANUFACTUTER’S PRODUCT WARRANTY – INGOT COLLECTION - AUGUST 2021

10 PRODUCT CARE INSTRUCTIONS

INGOT HANDMADE METAL COLLECTION PRODUCT CARE INSTRUCTIONS

JANUARY 2019

**WE STRONGLY RECOMMEND REGULAR USE
OF HIGH-QUALITY**

BREATHABLE FURNITURE COVERS

Our hand-hammered and hand crafted, Metal Ingot collection, is made by a small group of craftsmen who have learned their craft by knowledge passed down through the centuries. Nothing in this collection is mass produced, while we try to follow similar dimensional information and aesthetic appearances, every item in this collection will be unique. This is due to your beautiful piece of furniture or accent being crafted by individual craftsmen where beauty is perceived through the eyes of the craftsmen. To learn more about our Ingot production process, either follow us in the Seasonal Living Magazine or by logging on to SeasonalLiving.com. We hope that with minimal care, you will enjoy this product for decades to come indoors or outdoors.



WARNING! ALWAYS COMPLETELY READ AND FOLLOW ALL MANUFACTURER'S WARNINGS AND PRODUCT INSTRUCTIONS. FAILURE TO DO SO, CAN LEAD TO DAMAGE OR LOSS OF PROPERTY, SEVERE BODILY INJURY TO YOU AND OTHERS AND IN SOME CASES, DEATH. ALWAYS SUPERVISE CHILDREN WHEN ON OR NEAR FURNITURE AND DO NOT PERMIT FURNITURE TO BE USED IN ANY MANNER OTHER THAN THE WAY IT IS INTENDED OR DESIGNED FOR.

FABRICATION OF YOUR INGOT COLLECTION FURNITURE OR DECORATIVE ACCENT

Each piece is supported by an interior structural support or skeleton providing strong, rigid structure for in or outdoor use. Each piece of the steel interior structure is powder-coated minimizing the chances of rusting of the steel support structure. Adjustable levelers are attached on the base of most items at the corners specifically in this collection allowing

you to adjust heights and levels to create a stable surface on an uneven surface. Always make sure that each piece is perfectly level at all times. Levelers are adjusted by rotating the levelers on the base of each Ingot piece. Failure to create level/stable furniture or decorative items can lead to your merchandise tipping or falling and damaging the exterior metal structure and or causing bodily injury to you or to others. **ALWAYS MAKE SURE THAT ALL FURNITURE USED IS PERFECTLY LEVEL AT ALL TIMES.** Do not drag, pull or push any item in this collection. **WARNING!** Always use the help of another able-bodied adult to unpack, assist with lifting, assembling, moving or re-packing.

OUTER METAL SURFACE

The exterior metal on your Ingot collection is a testament to fine hand craftsmanship. No two pieces are identical. Enjoy the uniqueness of each handmade piece of furniture or decorative accessory. Each Ingot item is coated in hand-hewn metal which is either dipped in other metals to provide a dazzling array of colors or finishes. Beneath the surface patina, is a sheet of metal.

Our Handmade Metal Collection includes a protective finish and Sealant. This clear coat sealant is just to protect the metal finish from weather **

In order to keep your Ingot merchandise looking good for years to come, we recommend the following:

Simple Product Care steps to take to protect your Ingot Collection Product:

- When not using the decorative accessory or furniture item, use a breathable ventilating furniture cover.
- Protect against heat damage marks: Such marks can become visible from placing hot pots or pans directly on the surface, **ALWAYS** use a hot pad coaster or placemats (with a soft underside) for anything that comes directly from the oven or stove to protect the metal and Sealant.
- Avoid the hot wax from candles; boiling water or any kind of hot liquids coming into contact with the Ingot merchandise item, this could damage the protective sealant/coating.
- * Never store any item directly on top of the surface, of any Ingot Product. Doing so could easily scratch, dent, puncture, or compromise the sealant that is applied to protect the finish.

10 PRODUCT CARE INSTRUCTIONS

- Avoid leaving pieces of fruit such as lemons, limes, oranges, grapefruit, tomatoes or pineapple sitting on the top. The same for mustard, coffee, wine, salsa, ketchup (or other tomato based sauces) and vinegar, so make sure that any surface spills are always wiped up quickly. This will help avoid the appearance of white spots on any part of the metal surface.
- Avoid allowing food to come in direct contact with the surface.
- Using a soft, clean cloth, wipe up any spills immediately.
- After each use, please make a very quick and light wipe-down with a clean, soft cloth to remove standing water held on the surface.
- A table should not be used as a cutting or chopping board. The metal surface is not designed to withstand chopping and or cutting directly on the surface. When using forks, knives or other sharp utensils at the table, be sure to have dishes and placements on the table top to avoid scraping, chipping and nicking the metal's surface.
- Do not use any type of abrasive cleaners such as Soft Scrub, Mr. Clean liquid or pads or any chemical or ammonia-based agents to clean your Ingot Collection item.
- Always use the help of another able-bodied adult to help you pick up and move any Ingot Item.
- Do not drop or allow any heavy impacts on to or into any of the Ingot collection. Doing so can lead to metal indentations/dents or damage to the external surface and or finish.
- DO NOT write directly on to any of the Ingot metal surface. ALWAYS use a soft pad below any stationery or paper on to which you are writing. Writing on to paper with no protection can cause imprints in the metal surface.
- Always use a soft, non-abrasive cloth to lightly wipe or remove dirt and or dust.

** Scratches and or dents to the decorative metal exterior surfaces may reduce the protective nature of the clear coat sealent

MAINTENANCE INSTRUCTIONS:

- Regular cleaning of the product should be done with mild dish soap, a soft, nonabrasive clean cloth and warm water. Rinse thoroughly, wipe off any remaining water. Use a dry, soft (non-abrasive) cloth to remove all water.
- Product Installed Outdoors will need regular attention and care. Rain, wind, sand, hail, snow and numerous other weather elements, will wear away at the metal, tarnishing and aging its appearance quickly. ALWAYS use a breathable protective furniture cover when not using the merchandise.
- In case your product has a sealant, we recommend re-applying a clear sealant at least two (2) times a year to help maintain the original patina finish. Recommended brands: Clear Coat Sealent.
- For further protection, re-coat with Clear Coat Sealent product every 2 years.
- Do not use polishing compound, or equivalent for the surface, as this will remove the protective coating.

PRODUCTS NOT TO USE ON A (COPPER, ALUMINUM, BRASS OR CARBON STEEL) INGOT COLLECTION PRODUCT

- Chemical cleaners. Strong chemicals can eat away at finishes and cause negative reactions on surfaces. Products to avoid when cleaning your (C, A, B or CS) product include:
 - Bleach, ammonia, rubbing alcohol and baking soda.
 - Products manufactured for wood, tile or window cleaning.
 - Abrasive cleaners OR other types of metal cleaners
 - Polishing compounds not meant for this purpose.
- Products that are chemically engineered to kill germs and bacteria. This can tear through lacquers and cause discoloration on the surface.

10 PRODUCT CARE INSTRUCTIONS

HOW THIS FURNITURE OR DECORATIVE ITEM MUST BE USED

Chairs and or stools are ONLY intended for sitting on by one person at a time. Never climb on to, jump on or off, stand on or use as a ladder or stepping stool

Tables are never to be climbed on to, stood on, jumped on or off or used in any other manner than for sitting next to

Fire tables and Fire Pedestals in this collection – STRICTLY FOLLOW MANUFACTURER'S ASSEMBLY AND OPERATING INSTRUCTIONS AT ALL TIMES AS OUTLINED IN THE USER MANUAL. ALWAYS make sure that all Fire tables and or Fire Pedestals are installed correctly and adjust the levelers (at the base of each table or pedestal) to make certain that the pedestal or table is perfectly even and level creating a stable surface. All fire pedestals MUST be located / placed in locations that prevents them from blowing over. Do not use/operate during strong winds. **NEVER leave any fire at any time, doing so is highly dangerous.**

DO NOT allow children to play on or around any fire pedestal or fire table at any time

Caution! This product is crafted from metal. Strong, direct & continual sunlight on metal can possibly cause the metal to become hot to the touch. We recommend using this product in a more sheltered location away from long periods of heavy sunlight. Approach the merchandise with care to test if it is overly hot. If it is hot to the touch warn others. **ALWAYS supervise children.**

WARNING! Tables and chairs/stools must NEVER be used to be climbed on to, no standing on, no jumping on or off any table or chair. Do not use tables, fire pedestals or chairs as step ladders, they are not designed for this purpose. Chairs or stools are ONLY designed to support the weight of one average person (MAX weight load 250 LBS) at a time. Do not allow more than one (1) person to sit on the same chair or stool at the same time. All chairs and stools MUST remain fully in contact with a level ground surface at ALL TIMES. DO NOT permit any child to play on or under any furniture at any time. DO NOT permit children to play in or with any furniture packaging materials (plastic bags, carton boxes, foam, crates) at any time, failure to do so can lead to physical injury, suffocation and or death

FAILURE TO FOLLOW THIS WARNING, MAY LEAD TO: DAMAGE OR LOSS OF PROPERTY, SEVERE BODILY INJURY AND IN SOME CASES DEATH.

Any Product that is not cared for in the manner described in these Product Care Instructions or is abused or not used in the manner in which it is intended and or designed is not covered by the Manufacturer's Product Warranty. Neither the Manufacturer, nor Seasonal Living have any liability whatsoever with respect to any property damage or bodily injury or death related in any way to any improper use.

**SEASONAL LIVING – INGOT COLLECTION -
PRODUCT CARE INSTRUCTIONS –
AUGUST 2021**



SEASONAL LIVING[®]

FOR AN ELECTRONIC COPY OF THIS SAFETY & USER OPERATION MANUAL
EITHER SCAN THIS QR CODE AND OR VISIT:
<http://www.seasonalliving.com/burner-manual>



REMEMBER: ALWAYS THINK AND ACT SAFELY AROUND FIRE.
WE HOPE YOU ENJOY YOUR PURCHASE