



## Operator's Manual for:

# *NL Series*

## Public Use Wheelchair Lifts

### DOT — Public Use Lift

"DOT — Public Use Lift" verifies that this platform lift meets the "public use lift" requirements of FMVSS No. 403. This lift may be installed on all vehicles appropriate for the size and weight of the lift, but must be installed on buses, school buses, and multi-purpose passenger vehicles other than motor homes with a gross vehicle weight rating (GVWR) that exceeds 4,536 kg (10,000 lb).



"Providing Access to the World"®

International Corporate Hdqrs: P.O. Box 310 Winamac, IN 46996 USA  
1-800-THE LIFT® (574) 946-6153 FAX: (574) 946-4670



### ⚠ WARNING



Read manual before operating lift. Failure to do so may result in serious bodily injury and/or property damage. Keep manual in lift storage pouch.

Braun NL Series

# Congratulations

We at The Braun Corporation wish to express our fullest appreciation on your new purchase. With you in mind, our skilled craftsmen have designed and assembled the finest lift available.

This manual includes safety precautions, lift operating instructions, manual operating instructions, and instructions for maintenance and lubrication procedures.

Your lift is built for dependability, and will bring you years of pleasure and independence, as long as maintenance is performed regularly and the lift is operated by an instructed person.

Sincerely,

THE BRAUN CORPORATION

A handwritten signature in black ink that reads "Ralph W. Braun". The signature is written in a cursive style with a long, sweeping underline.

Ralph W. Braun  
Chief Executive Officer

# Contents

<b>Warranty/Registration Instructions</b> .....	2, 3	Outer Barrier Latch .....	20, 21
<b>Lift Terminology</b>		Outer Barrier and Latch Operation .....	21
Lift Terminology Illustration .....	4	Bridging .....	21
Introduction .....	5	Handrails .....	21
Direction .....	5	<b>Lift Passengers</b>	
Lift Components .....	6, 7	Passenger Orientation (Boarding Direction) .....	22
Vehicle and Lift Interlocks .....	7	Standees .....	22
Lift Actions and Functions .....	8	Yellow Boundaries .....	22, 23
<b>Lift Operation Safety</b>		Vehicle (Floor Level) Loading and Unloading .....	23, 24
Safety Symbols .....	9	Wheelchair-Equipped Occupant Seat Belts .....	25
Lift Operation Safety Precautions .....	10-13	Operation Procedure Review .....	25, 26
<b>Operation Notes and Details</b>		Preventive Maintenance .....	26
Introduction/Lift Access Doors and Interlocks .....	14	<b>Lift Operating Instructions</b> .....	27-31
General Safety .....	15	<b>NHTSA Operations Checklist</b> .....	32
Control Switches .....	15	<b>Manual Operating Instructions</b> .....	33-37
Lift Features		<b>Decals and Antiskid</b> .....	38-40
Lift-Tite Latches™ .....	16, 17	<b>Maintenance and Lubrication</b> .....	41-49
Inner Roll Stop .....	18, 19	<b>Limited Warranty</b> .....	50-57
Outer Barrier .....	19, 20		

# Warranty and Registration Instructions

Immediately upon receiving your lift, examine the unit for any damage. Notify the carrier at once with any claims.

Two warranty/registration cards (shown below) are located in the pump cover owner's manual storage pouch. The sales representative must process one of the cards. The consumer must fill out

the other card and mail it to The Braun Corporation. The warranty is provided on the back cover of this manual. The warranty cards must be processed to activate the warranty.

Two Braun Serial No./Series No. identification tags are posted on the lift. One I.D. tag (shown below) is posted on the opposite pump side

vertical arm. A second I.D. tag is located on the opposite pump side tower. Both I.D. tags provide the product identification information appearing on the Warranty/Registration card. Record the information in the space provided on the next page.

This information must be provided when filing a warranty claim or ordering parts.

Series No.      Pump Code  
Model No.      Serial No.      Cylinder Code

OWNER'S WARRANTY REGISTRATION	
NL9171B-04-02730-56-14CG	
PURCHASED FROM _____	
OWNER _____	
NAME _____	DATE INSTALLED _____
ADDRESS _____	
CITY _____	
TELEPHONE _____	STATE _____ ZIP _____
TO VALIDATE WARRANTY REGISTRATION CARDS MUST BE RETURNED TO THE BRAUN CORPORATION.	

Sample  
Warranty/Registration  
Card

<b>The Braun Corporation</b> 1-800-THE LIFT™ BRAUNLIFT.COM™	
DOT Public Use Lift MODEL#	
NL9171B	
Max. Lifting Capacity - 800 lbs.	
SERIAL NUMBER	
01-00025	
PUMP CODE	CYLINDER
56	14CG
MFG DATE	
10/24/04	
 e5*72/245*95/54*0110*00 <small>PATENT PENDING- 5,261,779-6,065,924-6,238,169-6,46 4,447-6,599,079-6,692,217-6,739,824</small>	

Sample  
Serial No./Series No.  
Identification Tag

## Warranty and Registration Instructions

Model No. \_\_\_\_\_ Pump Code \_\_\_\_\_

Series No. \_\_\_\_\_ Cylinder Code \_\_\_\_\_

Serial No. \_\_\_\_\_ Date of Manufacture \_\_\_\_\_

Note: This information must be provided when filing a warranty claim or ordering parts. Keep for future use.

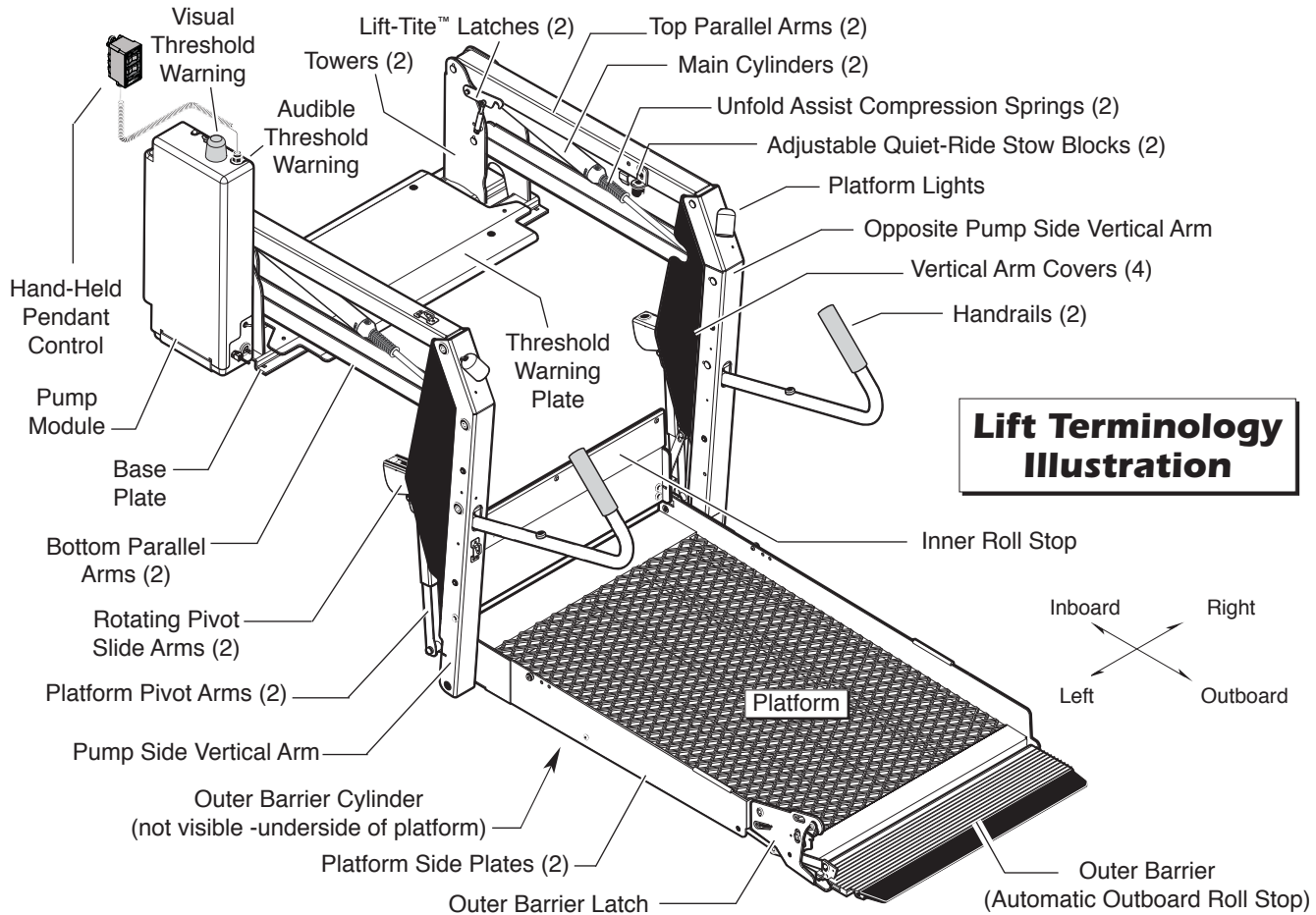

## Lift Terminology

### Introduction:

Braun NL Millennium Series lifts are ADA compliant and comply fully with National Highway Traffic Safety Administration (NHTSA) specifications. The NL is commercial oriented (intended for operation by an attendant).

Lift models vary per size (lift model numbers indicate lift dimensions). NL Series lift models can be equipped with left or right side pump modules as needed. A left side pump-equipped lift model is depicted in the Lift Terminology Illustration (NL917IB). Right side pump lift models are a mirrored image of rear pump models

(pump module located on opposite end of base plate).

Refer to the Lift Terminology Illustration for identification of lift components.

Lift operation procedures are identical for all NL Series lift models. The operating instructions contained in this manual and appearing on lift-posted operating instructions decals address the lift control switches and the corresponding lift functions. Instructions are provided for manual operation of the lift in event of power or equipment failure.

**Terminology:** Become familiar with the terminology that will be used throughout this manual. Become familiar with the identification of lift components and their functions. Contact your lift sales representative or call The Braun Corporation at 1-800-THE LIFT® if any of this information is not fully understood.

**Direction:** The terms "left," "right," "inboard," and "outboard" will be used throughout this manual to indicate direction (as viewed from outside the vehicle looking directly at the lift). Refer to the Lift Terminology Illustrations for clarification of direction terms.

## Lift Terminology

### Lift Components

Refer to the Lift Terminology Illustration on page 4.

**Pump Module:** The lift-mounted pump module consists of the hydraulic pump, the manual hand pump, the electronic control board and electrical components that power the lift electric/hydraulic systems.

**Hand-held Pendant Control:** The hand-held attendant's pendant control is connected to the pump module. The hand-held pendant is equipped with two rocker switches, (UNFOLD, FOLD, DOWN, and UP). The momentary switches activate the automatic lift functions.

**Lift Frame:** The lift frame consists of the base plate, threshold warning plate, towers, parallel arms, vertical arms, platform pivot arms and handrails. Two main hydraulic cylinders are housed in the parallel arms. The electrical/hydraulic powered lift frame components mechanically unfold, lower, raise and fold the lift platform assembly.

**Platform Assembly:** The platform assembly consists of the steel tubing frame with grating surface upon which the wheelchair is positioned, the outer barrier, outer barrier latch, the inner roll stop, and the hydraulic cylinder assembly that powers the outer barrier.

**Lift-Tite™ Latches:** The spring-loaded latches prevent the platform from unfolding from the stowed position in the event of platform drift. Further details regarding Lift-Tite™ latches are provided on pages 16 and 17.

**Outer Barrier:** The cylinder-powered automatic outer barrier provides a ramp for wheelchair loading and unloading at ground level. Photos and further details regarding the outer barrier are provided in the Operation Notes section (pages 19-21).

**Outer Barrier Latch:** The spring-loaded latch locks the outer barrier in the vertical position when the platform raises above ground level.



## Lift Terminology

**Inner Roll Stop:** NL Series lift models are equipped with an automatic inboard roll stop that also serves as the bridge plate. The roll stop bridges the gap between the lift platform and the vehicle floor. The inner roll stop automatically rotates from the horizontal position to the vertical position as the lift lowers and raises. Further details regarding the automatic mechanical inboard roll stop are provided on pages 18 and 19.

### Vehicle and Lift Interlocks

Braun Corporation NL9171B Series lifts comply fully with all NHTSA vehicle and lift interlock specifications. Vehicle movement is prohibited unless the lift is fully stowed and the lift will not function unless the vehicle is parked and secured.

The NL features a visual and audible threshold warning system that will activate if the threshold area is occupied when the platform is one inch or more below floor level.

The inner roll stop and outer barrier sense weight to prohibit lift operation. The lift will not function if the inner roll stop or

the outer barrier are occupied. The lift platform cannot be folded (stowed) if occupied.

The inner roll stop features a locking mechanism that prohibits the platform from lowering if the lock does not engage. The lift platform cannot be raised more than 3" above ground level unless the outer barrier is in the vertical position and the outer barrier latch is positively engaged.

## Lift Terminology

### Lift Actions and Functions

#### DEPLOY (A-C)

##### A. UNFOLD (Out) - Platform

**Unfold:** Unfold is the action of the platform rotating out and down from the fully-stowed (vertical) position to floor level (horizontal) position when the UNFOLD switch is pressed.

##### B. DOWN - Platform Lower:

Down is the action of the platform lowering from floor level position to fully-lowered (ground level) position when the DOWN switch is pressed.

##### C. DOWN - Outer Barrier

**Unfold (Deploy)** - When the platform reaches the fully-low-

ered (ground) position and the DOWN switch is continued to be pressed, the outer barrier rotates downward from vertical position to ramp position.

#### STOW (D-F)

##### D. UP - Outer Barrier Fold

**(Raise):** When the lift is fully lowered and the outer barrier is in the ramp position, pressing the UP switch first rotates the outer barrier upward from ramp position to vertical position.

**E. UP - Platform Raise:** Up is the action of the platform raising from ground level to floor level (fully-raised) position when the UP switch is pressed.

##### F. FOLD (In) - Platform Fold:

Fold is the action of the platform rotating up and in from the floor level (horizontal) position to fully-stowed (vertical) position when the FOLD switch is pressed.

**Stowed Position:** The lift is stowed when the lift platform has been fully raised and folded fully (vertical position).

**Floor Level:** Floor level is the position (height) the platform assembly reaches in order for the wheelchair passenger to enter and exit the vehicle (fully raised). The platform automatically stops at floor level when unfolding from the stowed position and when raising from ground level.

# Lift Operation Safety

## Safety Symbols

**SAFETY FIRST!** Know That....

**A** All information contained in this manual and supplements (if included), is provided for your safety. Familiarity with proper operation instructions as well as proper maintenance procedures are necessary to ensure safe, troublefree operation. Safety precautions are provided to identify potentially hazardous situations and provide instruction on how to avoid them.

**B**



**C**

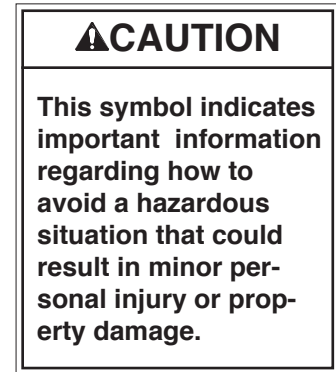

**D** **Note:** Additional information provided to help clarify or detail a specific subject.

These symbols will appear throughout this manual as well as on the labels posted on your lift. **Recognize the seriousness of this information.**

# Lift Operation Safety

## Lift Operation Safety Precautions

### **⚠️ WARNING**

If the lift operating instructions, manual operating instructions and/or lift operation safety precautions are not fully understood, contact The Braun Corporation immediately. Failure to do so may result in serious bodily injury and/or property damage.

**⚠️ WARNING** Read manual and supplement(s) before operating lift. Read and become familiar with all safety precautions, operation notes and details, operating instructions and manual operating instructions before operating the lift. Note: Wheelchair passengers and all transit agency personnel (drivers and wheelchair lift attendants) must read and become familiar with the contents of this manual and supplement(s) before operation.

**⚠️ WARNING** Load and unload on level surface only.

**⚠️ WARNING** Engage vehicle parking brake before operating lift.

**⚠️ WARNING** Provide adequate clearance outside the vehicle to accommodate the lift before opening lift door(s) or operating lift.

**⚠️ WARNING** Inspect lift before operation. Do not operate lift if you suspect lift damage, wear or any abnormal condition.

**⚠️ WARNING** Keep operator and bystanders clear of area in which the lift operates.

## Lift Operation Safety

### **⚠️WARNING**

Whenever a wheelchair passenger (or standee) is on the platform, the:

- Passenger must be positioned fully inside yellow boundaries
- Wheelchair brakes must be locked
- Inner roll stop and outer barrier must be up (vertical)
- Outer barrier latch must be fully engaged
- Passenger should grip both handrails (if able).

### **⚠️WARNING**

Load and unload clear of vehicular traffic.

### **⚠️WARNING**

Do not overload or abuse. The load rating applies to both the raising and lowering functions - continuous lifting capacity is 800 lbs.

### **⚠️WARNING**

Discontinue lift use immediately if any lift or vehicle interlock does not operate properly.

### **⚠️WARNING**

Do not operate or board the lift if you or your lift operator are intoxicated.

### **⚠️WARNING**

Do not raise front wheelchair wheels (pull wheelie) when loading (boarding) the platform.

### **⚠️WARNING**

Open lift door(s) fully and secure before operating lift.

### **⚠️WARNING**







Position and secure (buckle, engage, fasten, etc.) the wheelchair-equipped occupant seat belt (torso restraint) before loading onto the wheelchair lift platform.

# Lift Operation Safety

## Lift Operation Safety Precautions (continued)

### **WARNING**

If the lift operating instructions, manual operating instructions and/or lift operation safety precautions are not fully understood, contact The Braun Corporation immediately. Failure to do so may result in serious bodily injury and/or property damage.

-  **WARNING** Lift attendants must ensure that lift occupants keep hands, arms and all other body parts within the lift occupant area and clear of moving parts.
  -  **WARNING** Platform must be positioned at floor level (roll stop height) when loading or unloading in and out of vehicle.
  -  **WARNING** Do not use platform inner roll stop or outer barrier as a brake. Stop and brake wheelchair when loading onto the platform (manually stop and brake manual wheelchairs — stop powered wheelchairs with the wheelchair controls).
  -  **WARNING** Turn powered (electric) wheelchairs off when on lift platform.
  -  **WARNING** Press the DOWN switch until the entire platform rests on ground level (lowered fully) and the outer barrier is fully unfolded (ramp position) before loading or unloading a passenger at ground level.
-  **WARNING** Outer barrier must be fully unfolded (ramp position) until front and rear wheelchair wheels cross the barrier when loading or unloading at ground level.

## Lift Operation Safety

- ⚠WARNING** Accidental activation of control switch(es) may cause unintended operation(s).
- ⚠WARNING** Maintenance and lubrication procedures must be performed as specified in this manual by authorized (certified) service personnel.
- ⚠WARNING** Replace missing, worn or illegible decals.
- ⚠WARNING** Keep owner's (operator's) manual in lift-mounted manual storage pouch at all times.
- ⚠WARNING** Never modify (alter) a Braun Corporation lift.
- ⚠WARNING** Do not use accessory devices not authorized by The Braun Corporation.
- ⚠WARNING** Do not remove any guards or covers.
- ⚠WARNING** Keep clear of any hydraulic leak.
- ⚠WARNING** Failure to follow these safety precautions may result in serious bodily injury and/or property damage.

## Operation Notes and Details

### **WARNING**

**Read and become familiar with all lift operation safety precautions, operation notes and details, operating instructions and manual operating instructions prior to operating the lift. If this information is not fully understood, contact The Braun Corporation immediately. Failure to do so may result in serious bodily injury and/or property damage.**

NL Series “Public Use” lift models are specifically designed to be operated by an attendant. The Lift Operating Instructions contained in this manual and posted on the lift provide instructions for operation of the lift only. Read and become familiar with all lift operation safety precautions, operation notes and details, operating instructions and manual operating instructions before attempting lift operation procedures.

**Lift Access Doors and Interlocks:** Attendants must become familiar with the vehicle lift access door system and vehicle interlock system(s). Transit vehicles and lift access door configurations vary. Door securement devices (latches, hooks, cables, etc.) and procedures to operate them vary.

Instructions for operation of vehicle interlocks and door securement systems are not addressed in this manual or on lift-posted operating instructions decals due to the variety of procedures required for operating them. Braun Corporation NL Series lifts comply fully with all NHTSA vehicle and lift interlock specifications (detailed on pages 7 and 32). Infringement of any lift interlock will prohibit lift operation.

It is the responsibility of the lift operator (attendant) to properly open, secure and close the vehicle lift door(s), to activate the vehicle interlock(s), to load and unload the wheelchair passenger (or standee) on and off the lift platform, and to properly activate all lift functions.



## Operation Notes and Details

**General Safety:** The lift operator (attendant) and bystanders must keep clear of the area in which the lift operates and clear of all moving parts. Lift attendants

must ensure that lift occupants (passengers) keep hands, arms and all other body parts within the lift occupant area and clear of moving parts.

### Control Switches

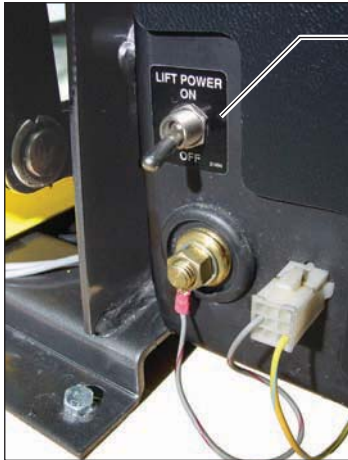

#### Lift Power ON/OFF Switch:

This switch must be in the ON position in order to activate the lift. The green Power Indicator Light mounted on top of the pump module illuminates to signal power to the lift.

#### Hand-held Pendant Control:

The hand-held attendant's pendant control is equipped with two rocker switches, (UNFOLD, FOLD, DOWN, and UP). The momentary switches activate the automatic lift functions.



Hand-held Pendant

Simply press the switch labeled for the intended function.

# Operation Notes and Details

## Lift Features

Become familiar with all lift features and the proper operation of the lift components before attempting lift operation. Refer to the Lift Terminology Illustrations

for identification of specific lift components if not clearly depicted in this section. Contact The Braun Corporation at 1-800-THE LIFT® immediately if any of this

information is not understood.

**Lift-Tite™ Latches:** NL Series lifts are equipped with Lift-Tite™ Latches. Lift-Tite™ Latches pre-

**⚠ WARNING**

Discontinue lift use immediately if any lift component does not operate properly. Failure to do so may result in serious bodily injury and/or property damage.

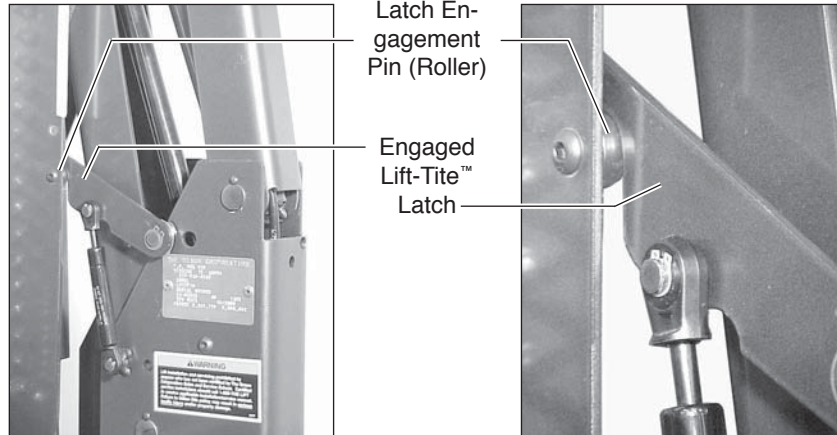

## Operation Notes and Details

vent the platform from unfolding from the stowed position in the event of platform drift. Due to the “all-hydraulic” operation of the dual-cylinder NL, hydraulic fluid expansion, contraction or seepage may occur. Any of these conditions may result in platform drift (failure to hold the platform in the folded or raised position). Platform drift may occur during lift shipment and/or between extended periods of non-lift use.

In the event that the platform does not unfold when the UNFOLD switch is pressed, press the FOLD switch momentarily to disengage the Lift-Tite™ latches (platform drift has occurred). Then, press the UNFOLD switch to unfold the

platform to floor level (standard operation).

When manually operating a lift equipped with Lift-Tite™ latches, insert the pump handle in the pump and stroke until the platform folds fully (stops). Then,

open the hand pump valve (turn counterclockwise) to unfold the platform. Folding the platform fully first will ensure that the Lift-Tite™ latches will disengage properly when the release valve is opened. Manual Operating Instructions are provided on pages 33-37.

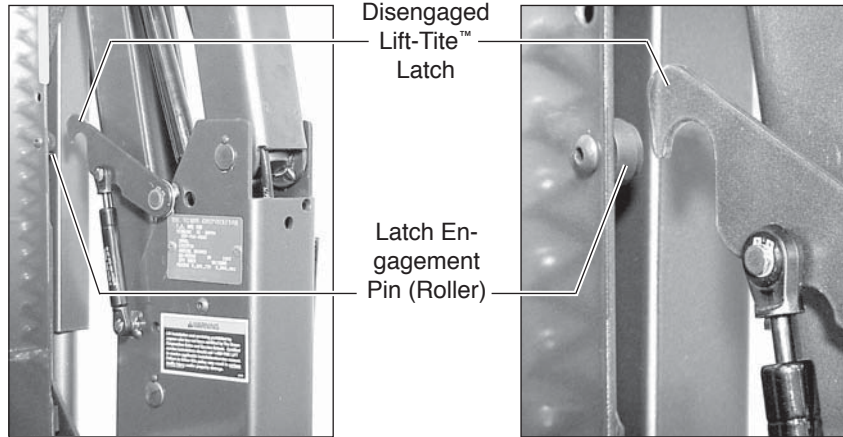

## Operation Notes and Details

### Lift Features (continued)

**Inner Roll Stop:** NL Series lift models are equipped with an automatic inner roll stop that also serves as the bridge plate (inner roll stop photos below).

When the UNFOLD switch is

pressed and the platform unfolds from stow position to floor level, this mechanical roll stop is automatically deployed to the bridging (horizontal) position to provide a bridge plate between the platform and the lift base plate (vehicle floor). The inboard edge of the bridge plate rests on the threshold warning plate (base plate).

The roll stop automatically folds (rotates) to the vertical (roll stop) position when the platform lowers to the ground (DOWN switch is pressed).

As the UP switch is pressed and the platform raises from ground level, the inner roll stop automatically unfolds (rotates) to the



Fully-Deployed (vertical) Inner Roll Stop	Fully-Unfolded (horizontal) Inner Roll Stop (bridging position)
--	--

### Inner Roll Stop

The inner roll stop must overlap the base plate a minimum 1/2".



## Operation Notes and Details



horizontal (bridging) position when it reaches vehicle floor level. The roll stop must overlap the lift base plate a minimum 1/2".

When the FOLD switch is pressed and the platform folds from floor level to the stow (vertical) position, the roll stop auto-

matically travels inboard to the stowed position.

**Interlock Features:** The inner roll stop features a locking mechanism that prohibits the platform from lowering if the lock is not engaged. The inner roll stop also senses weight to prohibit lift operation. The lift will not function if inner roll stop is occupied.

Discontinue lift operation immediately if the inner roll stop does not operate properly.

**Outer Barrier:** This cylinder-powered barrier provides a ramp for wheelchair loading and unloading at ground level (see photos on following page). When the platform lowers fully to ground level, the cylinder compression spring

automatically unfolds (rotates) the barrier to the ramp position (fully unfolded).

Although the outer barrier is lift-powered, the activation of the barrier is controlled by the lift operator (attendant). Pressing the DOWN switch unfolds the barrier. The outer barrier is cylinder-powered to automatically fold (rotate) to the vertical position as shown when the UP switch is pressed (barrier raises before platform raises).

**Interlock:** The outer barrier senses weight to prohibit lift operation. The lift will not function if the outer barrier is occupied.

# Operation Notes and Details

## Lift Features (continued)

Discontinue lift operation immediately if the outer barrier does not operate properly.

**Outer Barrier Latch:** A spring-loaded latch engages the outer

barrier when the barrier rotates upward from ramp position to the vertical position (UP switch is pressed to raise the platform above ground level). Note: The platform must raise approximately three inches before the latch engages fully (see photos on

previous page).

**Interlock:** Lift platform movement shall be interrupted unless the outer barrier is raised (vertical position) and the outer barrier latch is positively engaged.

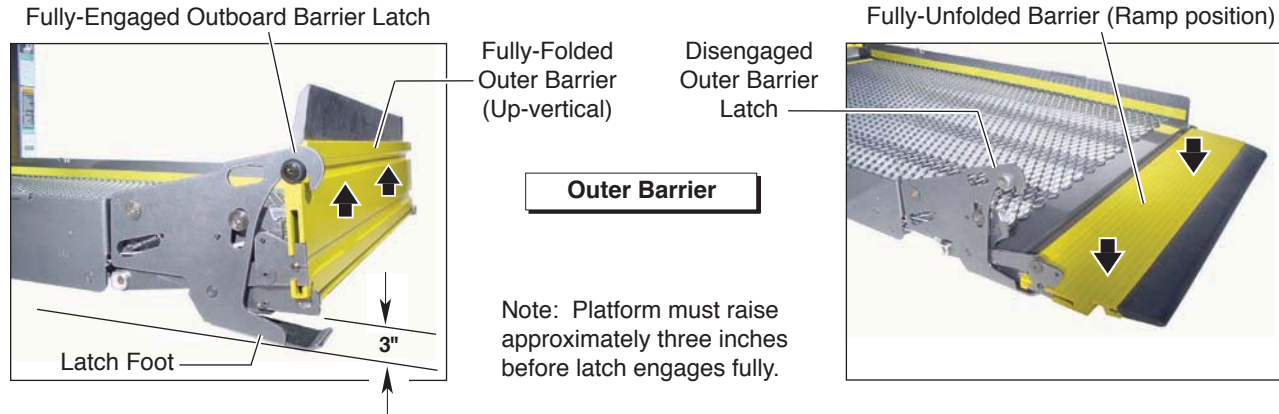

## Operation Notes and Details

The latch disengages the barrier when the platform lowers fully (reaches ground level) and the latch foot contacts the ground (latch raises above the barrier).

**Outer Barrier and Latch Operation:** The lift attendant must press the DOWN switch to lower the platform fully to the ground. The attendant must view the platform as it lowers to be certain the entire platform reaches and rests safely on the ground. Stop pressing the DOWN switch if any portion of the platform is obstructed while descending or the entire platform does not reach ground level for any reason (contact with an obstruction, mechanical failure, exceeding the lift “floor-to-ground” capacity, etc.).

After the platform is fully lowered, the attendant should continue to press the DOWN switch to unfold the outer barrier fully (ramp position). Note: The barrier must be fully unfolded until the entire wheelchair (or standee) has crossed the barrier when loading or unloading at ground level. Discontinue lift operation immediately if the outer barrier or latch do not operate properly.

**Bridging:** The NL incorporates a bridging feature. This feature stops the down travel of the platform if the outboard end of the platform contacts a raised surface (such as a curb), preventing the operator from lowering the inboard end of the platform.

**Handrails:** Dual handrails are provided for wheelchair passenger (or standee) use. The handrails unfold automatically to the deployed (horizontal) position when the lift unfolds and automatically fold to the stowed (vertical) position when the platform folds.

If able, passengers should grip both handrails when on the lift platform. Discontinue lift operation immediately if the handrails do not operate properly.

## Operation Notes and Details

### Lift Passengers

If you are an attendant operating the lift, it is your responsibility to perform safe loading and unloading procedures. Wheelchair lift attendants should be instructed on any special needs and/or procedures required for safe transport of wheelchair passengers.

The lift operator and bystanders must keep clear of the area in which the lift operates. Observe your passenger at all times during lift operation.

Do not attempt to load or unload a passenger in a wheelchair or other apparatus that does not fit on the platform area. Do not exceed the 800 pound load capacity

of the lift. The lift attendant should not ride on the platform with the passenger.

**Passenger Orientation (Boarding Direction):** Braun NL Series wheelchair lifts accommodate both inboard and outboard facing wheelchair passengers or standees. Inboard facing of wheelchair lift passengers is not prohibited, but outboard facing of passengers is recommended by The Braun Corporation.

Braun NL Series lifts permit both inboard and outboard facing of wheelchair and mobility aid users and accommodate persons using walkers, crutches, canes or braces or who otherwise have difficulty using steps.

**Standees:** Lift Operating Instructions apply to wheelchair passengers and standees. Standees should stand in the center of the platform (fully inside the yellow boundaries) and grip both handrails (if able) when on platform.

**Yellow Boundaries:** The passenger must be positioned in the center of the platform to prevent side-to-side load imbalance. The lift attendant (operator) should not ride on the platform with the passenger.

Yellow platform loading boundaries are identified in the following manner. The yellow powder-coated inner roll stop and outer barrier identify the inboard and outboard ends of the platform. A yellow powder-coated guard is lo-



## Operation Notes and Details

cated on the pump-side platform side plate. A yellow boundary strip decal is affixed to the opposite platform side plate. Yellow plastic caps are placed on the dual handrails.

The threshold warning plate is powder-coated yellow to identify the platform threshold area.

**Interlock:** A visible and audible threshold warning system will activate if the threshold area is occupied when the platform is one inch or more below floor level.

The attendant must always be certain the wheelchair passenger or standee is properly positioned on the platform (fully inside yellow boundaries) and the wheelchair brakes are locked when a

passenger is on the lift platform. The lift passenger must keep hands, arms and all other body parts within the lift occupant area and clear of all moving parts.

**Vehicle (Floor Level) Loading and Unloading:** The platform must be fully raised (at floor level) and the bridge plate must be properly positioned when loading or unloading passengers in or out of the vehicle. It is the responsibility of the lift attendant to ensure the platform and the bridge plate are properly positioned at floor level when loading and unloading passengers.

### **WARNING**

**Whenever a passenger is on the platform, the:**

- **Passenger must be positioned fully inside yellow boundaries**
- **Wheelchair brakes must be locked**
- **Inner roll stop and outer barrier must be UP**

**Failure to follow these rules may result in serious bodily injury and/or property damage.**

## Operation Notes and Details

### Lift Passengers (continued)

The wheelchair brakes must be locked, the outer barrier must be in the fully-up (vertical) position and the outer barrier latch must be fully engaged whenever a passenger is on the platform.

Do not use the outer barrier as a brake. Stop and brake the wheelchair when fully loaded on the platform. Manually stop and brake manual wheelchairs. Stop powered wheelchairs with the wheelchair controls. Turn powered (electric) wheelchairs off when on the platform.

If the outer barrier, inner roll stop, handrails or any other lift component does not operate as

outlined in this manual, discontinue lift use immediately and contact The Braun Corporation sales representative in your area or call The Braun Corporation at 1-800-THE LIFT®. One of our national Product Support representatives will direct you to an authorized service technician who will inspect your lift.

### WARNING

**Discontinue lift use immediately if any lift component does not operate properly. Failure to do so may result in serious bodily injury and/or property damage.**

## Operation Notes and Details

### Wheelchair-Equipped Occupant Seat Belts

The Braun Corporation recommends wheelchair passengers position and buckle their wheel-

#### **WARNING**

**Position and secure (buckle, engage, fasten, etc.) the wheelchair-equipped occupant seat belt before loading onto the wheelchair lift platform. Failure to do so may result in serious bodily injury and/or property damage.**

chair-equipped seat belt (torso restraint) before loading onto a wheelchair lift.

Different types of disabilities require different types of wheelchairs and different types of wheelchair-equipped occupant restraint belt systems (torso restraints). It is the responsibility of the wheelchair passenger to have his or her wheelchair equipped with an occupant restraint (seat belt) under the direction of their health care professional.

Wheelchair lift attendants should be instructed on any special needs and/or procedures required for safe transport of wheelchair passengers.

### Operation Procedure Review

The Braun Corporation recommends that transit agency supervisors and wheelchair lift attendants review the safety precautions and operation procedures appearing in this manual and on lift-posted decals with your wheelchair lift sales representative (dealer), before attempting lift operation.

Any questions or concerns can be addressed by the sales representative at that time. Operate the lift through all functions with your sales representative on hand to ensure the proper use and operation of the wheelchair lift is understood.

## Operation Notes and Details

Transit agency supervisors should train and educate their lift attendants on the proper use and operation of the wheelchair lift if it is not possible for the attendants to review the safety precautions and operation procedures with the wheelchair lift sales representative.

The lift operator's manual must be stored in the lift-mounted manual storage pouch at all times.

### Preventive Maintenance:

Maintenance is necessary to ensure safe and troublefree lift operation. General preventive lift maintenance consisting of careful inspections of the lift system and cleaning the lift should

be a part of your transit agency's daily lift service program. Simple inspections can detect potential lift operational problems.

Regular preventive maintenance will reduce potential lift operation downtime and increase the service life of the lift, as well as possibly detecting potential hazards.

Exposure to harsh weather elements, environmental conditions, or heavy usage may require more frequent maintenance and lubrication procedures.

Preventive maintenance visual inspections do not take the place of the procedures specified in the Maintenance and Lubrication Schedule provided on pages 41-

49 of this manual. Refer to the Maintenance and Lubrication section for further details.

### WARNING

**Maintenance and lubrication procedures must be performed by authorized service personnel as specified in this manual. Failure to do so may result in serious bodily injury and/or property damage.**

## Lift Operating Instructions

### **⚠️ WARNING**

Read and become familiar with all lift operation safety precautions, operation notes and details, operating instructions and manual operating instructions prior to operating the lift. If this information is not fully understood, contact The Braun Corporation immediately. Failure to do so may result in serious bodily injury and/or property damage.

### **⚠️ WARNING**

Whenever a passenger is on the platform, the:

- Passenger must be positioned fully inside yellow boundaries
- Wheelchair brakes must be locked
- Inner roll stop and outer barrier must be UP

Failure to follow these rules may result in serious bodily injury and/or property damage.

Before lift operation, park the vehicle on a level surface, away from vehicular traffic. Place the vehicle transmission in "Park" and engage the parking brake. Vehicle engine must be running.

Lift Operating Instructions photos depict lift model NL9171B. Instructions and procedures are applicable for all NL Series lift models. Lift-posted Warnings and Lift Operating Instructions decal 30695 provides lift operating instructions. Replace any missing, worn or illegible decals.

If your lift does not function as intended a visual or audible warning signal is activated, review the NHTSA Operations Checklist on page 32. Follow the Manual Operating Instructions on pages 33-37 to manually operate lift.

# Lift Operating Instructions



## Open Door(s) and Secure

### To Unfold Platform:

Stand clear and press the UN-FOLD switch until the platform stops (reaches floor level - unfolds fully). Release switch.

Note: In event platform does not unfold, press FOLD switch to release Lift-Tite™ latches.

### To Unload Passenger:

1. Read Note below! Load passenger onto platform and lock wheelchair brakes.

Note: Passenger must be positioned fully inside yellow boundaries, outer barrier must be UP and outer barrier latch must be engaged.



## Lift Operating Instructions



### To Unload Passenger (continued):

2. Press DOWN switch until the entire platform reaches ground level (see Photo B) and the outer barrier unfolds fully (ramp position). See Photo C. Release switch.



3. Unlock wheelchair brakes and unload passenger from platform.

Note: Outer barrier must be fully unfolded (ramp position) until the entire wheelchair (or standee) has crossed the outer barrier. See Photos E and F on page 30 also.



## Lift Operating Instructions

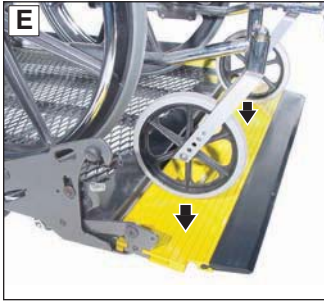

### To Load Passenger:

1. Read NOTES below! Load passenger onto platform and lock wheelchair brakes. See Photo G.

Note: Outer barrier must be fully unfolded (ramp position) until the entire wheelchair (or standee) has crossed the outer barrier. See Photos E and F.

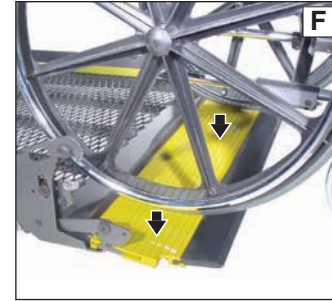

Note: Passenger must be positioned fully inside yellow boundaries.

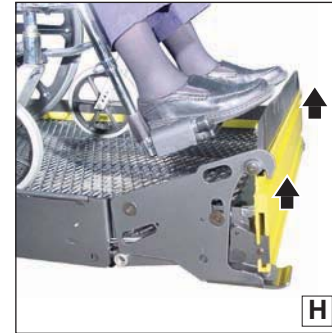



# Lift Operating Instructions

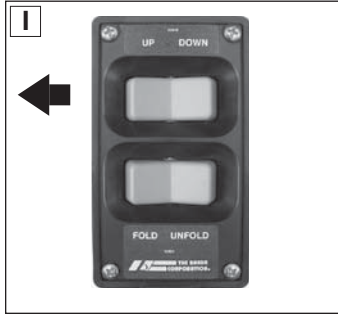

## To Load Passenger (continued):

2. Press UP switch (Photo I) to fold outer barrier UP fully (vertical - see Photo H), and raise the platform to floor level. See Photo J. Release switch.
3. Unlock wheelchair brakes and unload passenger from platform.



## To Fold Platform:

- Press FOLD switch until platform stops (fully folded). See Photos K and L. Release switch.

## Close Door(s)



# NHTSA Operations Checklist

The following operations have been verified upon installation. This operational checklist can be used at any time to verify the lift is fully functional.

Verified:

- Vehicle movement is prevented unless the lift door is closed, ensuring the lift is stowed.
  - Lift operation shall be prevented unless the vehicle is stopped and vehicle movement is prevented.
  - The platform will not fold/stow if occupied.
  - The inner roll stop will not raise if occupied.
  - The outer barrier will not raise if occupied.
  - Verify platform lighting\* when lift is deployed and pendant illumination when lift is powered.
  - A visual and audible warning will activate if the threshold area is occupied when the platform is at least one inch below floor level.
- Platform movement is prohibited beyond the position where the inner roll stop is fully deployed (up).
  - Platform movement shall be interrupted unless the outer barrier is deployed (up).



\*Public use vehicle manufacturers are responsible for complying with the lift lighting requirements in Federal Motor Vehicle Safety Standard No. 404, Platform Lift Installations in Motor Vehicles (49 CFR 571.404).

# Manual Operating Instructions

Instructions and photos are provided for all steps that differ from standard lift operation procedures. The Manual Operation decal (posted inside pump cover) provides manual

operating instructions also. Note: Inner roll stop and outer barrier automatically function during manual operations. Note: A right side pump lift model is depicted in the photos.

Left side pump applications are a mirrored image. Refer to the Lift Operating Instructions for all normal lift operation procedures. Follow all Lift Operation Safety Precautions!

Turn wing 1/4 turn.



Pump Cover



Hand Pump Handle

Rotate top clip to access handle.

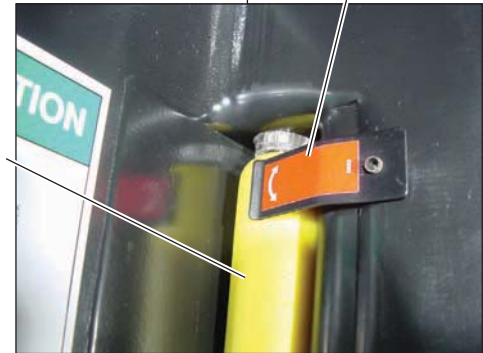

# Manual Operating Instructions

Remove the pump cover to gain access to the pump handle and the hand pump. See photos on page 33.

To remove the pump cover, turn the wing nut located on top 1/4 turn and lift the pump cover off.

The pump handle is inside this cover secured by two clips. Rotate the top clip to remove the pump handle.

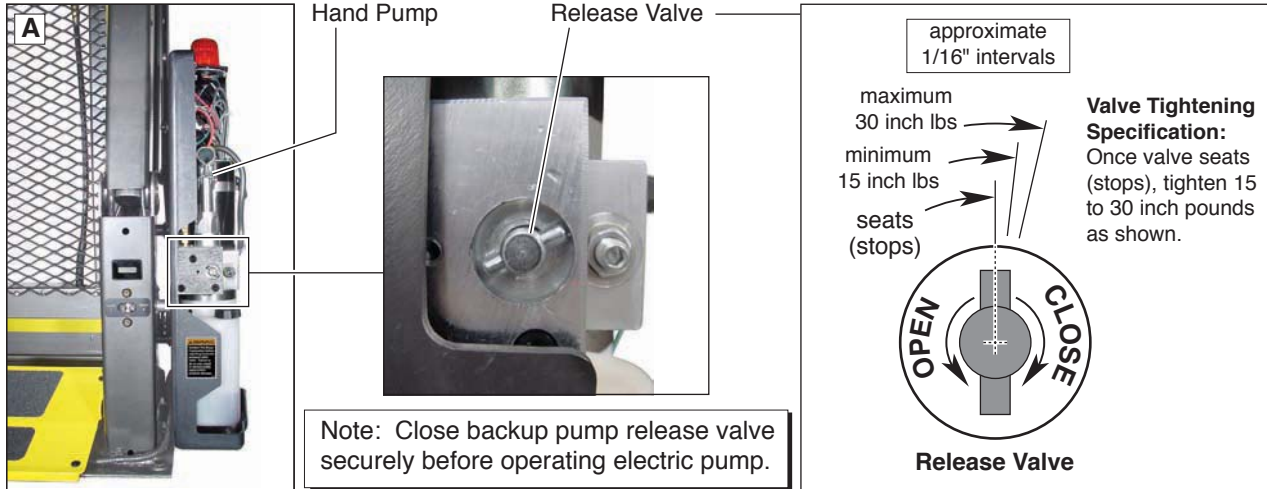

# Manual Operating Instructions

Remove pump cover to access hand pump and pump handle as outlined on page 33. Refer to release valve photos and illustration on page 34.



## To Unfold Platform (Out):

Using hand pump handle (Photo B):

1. Close hand pump valve (place slotted end of pump handle onto backup pump release valve and turn clockwise).
2. Insert handle in pump and stroke until platform folds fully (stops).
3. Open hand pump valve (turn counterclockwise) until platform reaches floor level. Open 1/2 turn only.
4. Close hand pump valve (turn clockwise).

Note: Valve must be tight, but do not overtighten.

## Down (To Lower):

Place slotted end of pump handle onto backup pump release valve and turn counterclockwise (open 1/2 turn only) until the platform reaches ground level and roll stop unfolds.

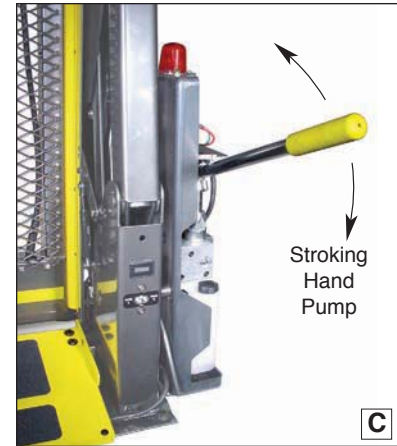

## Manual Operating Instructions

Remove pump cover to access hand pump and pump handle as outlined on page 33. Refer to release valve photos and illustration on page 34.



### Up (To Raise):

Using hand pump handle:

1. Place slotted end of pump handle onto backup pump release valve and turn clockwise to close securely. See Photo D.

Note: Valve must be tight, but do not overtighten.

2. Insert handle into backup pump and stroke until platform reaches floor level (see Photo E).

### To Fold Platform (In):

Insert handle into backup pump and stroke until platform stops (folds fully). See Photo E.

Note: Close backup pump release valve securely before operating electric pump.

Store pump handle and install pump cover as outlined on page 37.

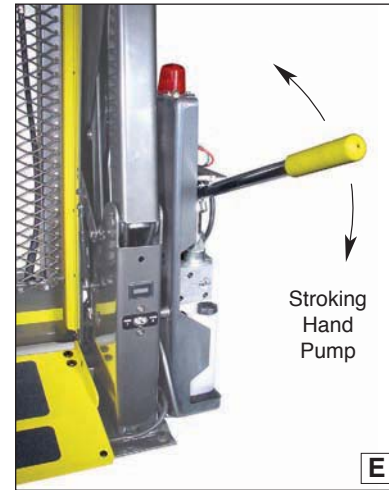

# Manual Operating Instructions

## To Store Pump Handle:

1. Insert bottom of handle behind bottom clip. See page 33.
2. Rotate top clip to secure (lock) handle.

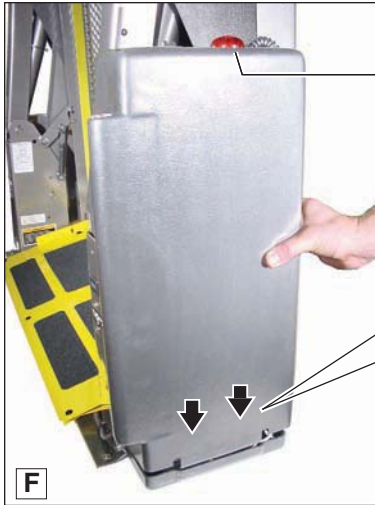

## To Install Pump Cover:

1. Position cover over module back cover and red warning light. See Photo F.
2. Align outside cover lip with bottom cover offset and insert outside cover. See Photo G.

Position cover over red light.

Align and insert bottom of cover.



3. Insert wing stud and rotate 1/4 turn to lock cover. See Photo H.



# Decals and Antiskid

**⚠ WARNING**

Replace missing, worn or illegible decals. Failure to do so may result in serious bodily injury and/or property damage.

Note: Clean surfaces as detailed on page 40 before posting decals.

25675

**⚠ WARNING**

Lift installation and servicing prohibited by anyone who has not been certified by The Braun Corporation Sales and Service School. Certified service technicians should call 1-800-THE LIFT to receive applicable installation/service manual. Failure to follow this policy may result in serious bodily injury and/or property damage.

25675

## Decals

The lift is only as safe as the operator. Replace any missing, worn or illegible decals! Part numbers are provided for decals. Inspect your lift for missing, worn or illegible decals. Call 1-800-THE LIFT® for replacements.

33221



29052



31412

**MANUAL OPERATION**

**TO REMOVE PUMP HANDLE:**

1. Rotate top clip.

Using hand pump handle:

**TO UNFOLD PLATFORM (OUT):**

1. Close hand pump valve (turn clockwise).
2. Insert handle in pump and stroke until platform folds fully (stop).
3. Open hand pump valve (turn counter-clockwise) until platform reaches floor level. Open 1/2 turn only.
4. Close hand pump valve (turn clockwise).

**DOWN (TO LOWER):**

Open hand pump valve (turn counter-clockwise). Open 1/2 turn only.

**UP (TO RAISE):**

1. Close hand pump valve (turn clockwise).
2. Insert handle in pump and stroke until platform reaches floor level.

**TO FOLD PLATFORM (IN):**

Insert handle in pump and stroke.

Note: Close valve before operating electric pump.

**TO STORE PUMP HANDLE:**

1. Insert bottom of handle behind bottom clip.
2. Rotate clip to lock.

DOT – Public Use Lift

31045

**OPERATING INSTRUCTIONS**

Read warnings and operate lift as outlined on LIFT OPERATING INSTRUCTIONS decal. Lift operating instructions apply to wheelchair passengers and standees.

Standees: Standees must stand at center of platform (fully inside yellow boundaries), grip handrails and lower head.

Interlocks: Interlocks vary in type and operation. Interlocks must be operational as defined in NHTSA Operations Checklist.

DOT – Public Use Lift

21494



30695

**⚠ WARNING**

- Read manual before operating lift.
- Load and unload on level surface only.
- Engage vehicle parking brake before operating lift.
- Provide adequate clearance outside of vehicle to accommodate lift.
- Do not operate lift if you suspect lift damage, wear or any abnormal condition.
- Keep operator and bystanders clear of area in which lift operates.

Whenever a wheelchair passenger is on the platform, the:

- Passenger must be positioned fully inside yellow boundaries.
- Wheelchair brakes must be locked.
- Lower roll stop and outer barrier must be up.

Failure to follow these rules may result in serious bodily injury and/or property damage.

**LIFT OPERATING INSTRUCTIONS**

**OPEN DOOR(S) AND SECURE**

**TO UNFOLD PLATFORM:**

Stand clear and press **UNFOLD** switch until platform stops (reaches floor level).

Note: In event platform does not unfold, press **FOLD** switch to release Lift-Tite™ latches.

**TO UNLOAD PASSENGER:**

1. Load passenger onto platform and lock wheelchair brakes.
2. Press **DOWN** switch until entire platform reaches ground level and outer barrier unfolds fully.
3. Unlock wheelchair brakes and unload passenger from platform.

**TO LOAD PASSENGER:**

1. Load passenger onto platform and lock wheelchair brakes.
2. Press **UP** switch to fold outer barrier up and raise platform to floor level.
3. Unlock wheelchair brakes and unload passenger from platform.

**TO FOLD PLATFORM:**

Press **FOLD** switch until platform stops. Release switch.

**CLOSE DOOR(S)**

DOT – Public Use Lift



# Decals and Antiskid

## Decals

32410

### LCD Lift Codes

Listed below are codes that the lift controller outputs during lift operation. The codes will be displayed on an LCD screen located on the lift control board inside the pump module.

#### Non-Flashing Numbers

- 01 - Platform stopped
- 02 - Platform unfolding
- 03 - Platform unfolding paused
- 04 - Platform at floor level
- 05 - Platform beginning to lower
- 06 - Platform lowering (mechanical cannot be occupied from this point down)
- 07 - Outer barrier moving to horizontal position
- 08 - Platform at ground level
- 09 - Outer barrier moving to vertical position
- 10 - Platform raising
- 11 - Platform raising paused at floor
- 12 - Platform folding (initial pressure)
- 13 - Platform folding (full pressure)
- 14 - Initial lift (pitching lift site) or (anti-rattle state)
- 15 - Platform folding stopped
- 16 - Paused full
- 17 - Platform between ground and 3" above ground
- 18 - Platform above 3"
- 19 - Outer barrier moving to horizontal position
- 20 - The doors are not fully opened (only applicable when door operators are installed)
- 21 - The doors are opening (only applicable when door operators are installed)
- 22 - The doors are closing (only applicable when door operators are installed)
- 26 - Illegal function(s) defined
- 29 - Threshold fault not recognized (or has been cleared but a motion button is still pressed)
- 30 - Platform location unknown
- 31 - Platform location transition state; attempting to locate position
- 35 - Two or more motion buttons are being pressed
- 36 - The retraction belt cannot be buckled while trying to hold or unfold
- 37 - Motion button being pressed is not a valid motion
- 50 - Outer barrier is not up above inboard barrier locked position
- 51 - Threshold is occupied when platform is 1" or more below floor level
- 52 - Inner rollostop is not up and locked below inner rollostop locked position
- 53 - Inner rollostop occupied sensor is not activated between floor and inner rollostop up position
- 54 - Outer barrier is occupied before it is up
- 55 - Outer barrier is not latched when above the inner rollostop locked position (Millennium only)
- 56 - Outer barrier is not up and latched and bridge switch did not deactivate

32410

34267



32845



31132



30787



32201

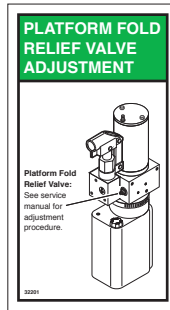

27154

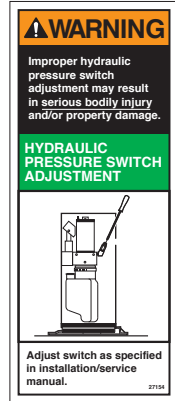

# Decals and Antiskid

## Decals

22249

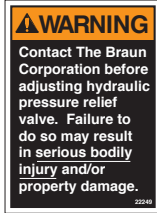

25652



29051

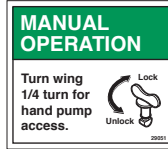

1" Wide Yellow Boundary Tape  
30236R  
(order by the inch as needed)



18229

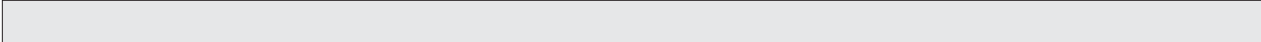

### Available Antiskid

Size	Color	Part No.
2" x 12"	Black	#24172-BK
2" x 12"	Yellow	#24172-YL
3" x 8"	Black	#31188-BK
3" x 12"	Black	#24173-BK
3" x 12"	Yellow	#24173-YL
6" x 12"	Black	#24174-BK
6" x 12"	Yellow	#24174-YL

Inspect your lift for any missing or worn antiskid. Order as needed. Note: Clean surfaces with isopropyl alcohol before decal or antiskid application. Use a clean cloth or paper towels. Do not use oily shop rags. Wipe surface free of residue with dry portion of cleaning cloth.

## Maintenance and Lubrication

Proper maintenance is necessary to ensure safe, troublefree operation. Inspecting the lift for any wear, damage or other abnormal conditions should be a part of the transit agency daily service program. Simple inspections can detect potential problems.

The maintenance and lubrication procedures specified in the following schedule must be performed by a Braun authorized service representative at the scheduled intervals according to the number of cycles.

NL Series lifts are equipped with hardened pins and self-lubricating bushings to decrease wear, provide smooth operation and extend the service life of the lift.

When servicing the lift at the recommended intervals, inspection and lubrication procedures specified in the previous sections should be repeated. Clean components and the surrounding area before applying lubricants. LPS2 General

Purpose Penetrating Oil is recommended where Light Oil is called out. Use of improper lubricants can attract dirt or other contaminants which could result in wear or damage to the components. Platform components exposed to contaminants when lowered to the ground may require extra attention.

Lift components requiring grease are lubricated during assembly procedures. When these components are replaced, grease must be applied during installation procedures. Specified lubricants are available from The Braun Corporation (part numbers provided on page 42).

### **WARNING**

**Maintenance and lubrication procedures must be performed as specified by an authorized service technician. Failure to do so may result in serious bodily injury and/or property damage.**

## Maintenance and Lubrication

All listed inspection, lubrication and maintenance procedures should be repeated at 750 cycle intervals following the scheduled 4500 cycle maintenance procedures. These intervals are a general guideline for scheduling maintenance procedures and will vary according to lift use and conditions. Lifts exposed to severe conditions (weather, environment, contamination, heavy usage, etc.) may require inspection and maintenance procedures to be performed more often than specified.

**Maintenance Indicator:** The Lift Ready green LED mounted on top of the pump cover will begin to blink after every 750 cycles. The blinking LED will not affect the functions of the lift, but is a

reminder to complete necessary maintenance and lubrication. Once the lift has been serviced, fully stow the lift. Once stowed, press the UP button on the hand pendant and the Floor Level Set button on the back side of the pump cover until the Lift Ready green LED stops blinking.

Discontinue lift use immediately if maintenance and lubrication procedures are not properly performed, or if there is any sign of wear, damage or improper operation. Contact your sales representative or call The Braun Corporation at 1-800-THE LIFT®. One of our national Product Support representatives will direct you to an authorized service technician who will inspect your lift.

See the Maintenance/Lubrication Schedule for recommended applications per number of cycles.

Lubricant	Type	Specified (recommended) Lubricant	Available Amount	Braun Part No.
<b>LO - Light Oil</b>	Light Penetrating Oil (30 weight or equivalent)	LPS2, General Purpose Penetrating Oil	16 oz. Aerosol Can	15807
<b>DE - Door-Ease</b>	Stainless Stick Style (tube)	Door-Ease Stick (tube)	1.68 oz.	15806
<b>LG - Light Grease</b>	Light Grease (Multipurpose)	Lubriplate	14 oz. Can	15805

# Lubrication Diagram

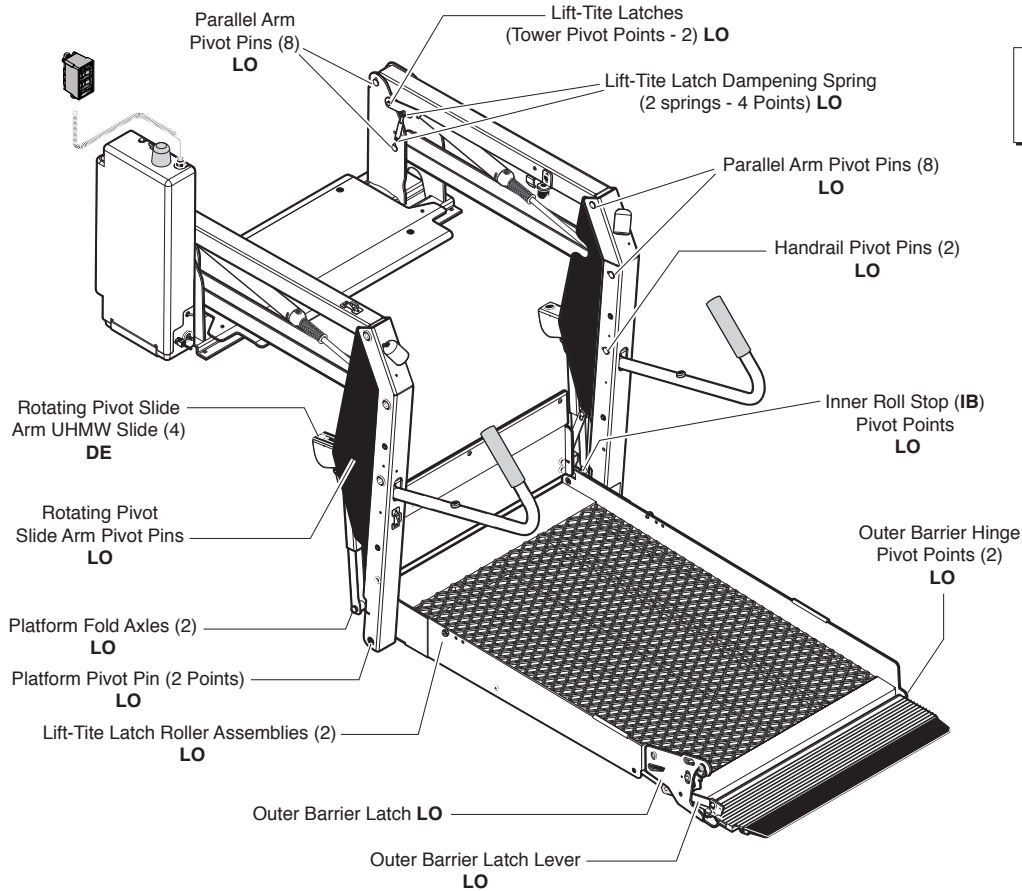

## Maintenance and Lubrication Schedule

<b>750 Cycles</b>	Outer barrier hinge pivot points (2)	Apply Light Oil - See Lubrication Diagram
	Outer barrier latch (pivot/slide points)	Apply Light Oil - See Lubrication Diagram
	Outer barrier latch lever pivot points	Apply Light Oil - See Lubrication Diagram
	Lift-Tite™ latches (tower pivot points - 2)	Apply Light Oil - See Lubrication Diagram
	Lift-Tite™ latch gas (dampening) spring pivot points (2 springs - 4 points)	Apply Light Oil - See Lubrication Diagram
	Inspect Lift-Tite™ latches and gas springs for wear or damage (bent, deformed or misaligned), positive securement (external snap rings) and proper operation	Resecure, replace damaged parts or otherwise correct as needed. Note: Apply Light Grease to Lift-Tite™ latch tower pivot point if replacing latch.
	Inspect outer barrier for proper operation	Correct or replace damaged parts.
	Inspect outer barrier latch for proper operation, positive securement, and detached or missing spring	Correct or replace damaged parts and/or relubricate. See Lubrication Diagram
	Adjust fold pressure and outer barrier fold pressure (if applicable)	See applicable service manual
Verify NHTSA Operations Checklist	See NHTSA Operations Checklist	

## Maintenance and Lubrication Schedule

<b>750 Cycles</b>	Inspect lift for wear, damage or any abnormal condition	Correct as needed.
	Inspect lift for rattles	Correct as needed.

<b>1500 Cycles</b>	<b>Perform all procedures listed in previous section also</b>	
	Platform pivot pin bearings (2)	Apply Light Oil - See Lubrication Diagram
	Platform fold axles (2)	Apply Light Oil - See Lubrication Diagram
	Inner roll stop lever bearings (2)	Apply Light Oil - See Lubrication Diagram
	Inner roll stop lever slot (2)	Apply Light Oil - See Lubrication Diagram
	Rotating pivot slide arm pivot pins (2)	Apply Light Oil - See Lubrication Diagram
	Parallel arm pivot bearings (16)	Apply Light Oil - See Lubrication Diagram
	Handrail pivot pin bearings (4)	Apply Light Oil - See Lubrication Diagram
	Hydraulic cylinder bushings (8)	Apply Light Oil - See Lubrication Diagram
Inspect Lift-Tite™ latch rollers for wear or damage, positive securement and proper operation (2)	Correct, replace damaged parts and/or relubricate.	

## Maintenance and Lubrication Schedule

<b>1500 Cycles</b>	<b>Perform all procedures listed in previous section also</b>	
	<p>Inspect inner roll stop for:</p> <ul style="list-style-type: none"> <li>• Wear or damage</li> <li>• Proper operation. Roll stop should just rest on top surface of the base plate.</li> <li>• Positive securement (both ends)</li> </ul>	Resecure, replace or correct as needed. See Platform Angle Instructions and Microswitch Adjustment Instructions.
	Inspect handrail components for wear or damage, and for proper operation	Replace damaged parts.
	Inspect microswitches for securement and proper adjustment.	Resecure, replace or adjust as needed. See Microswitch Adjustment Instructions.
	Make sure lift operates smoothly	Realign towers and vertical arms. Lubricate or correct as needed.
<p>Inspect external snap rings:</p> <ul style="list-style-type: none"> <li>• Handrail pivot pins (2 per pin)</li> <li>• Platform slide/rotate pivot pins (2 per pin)</li> <li>• Platform fold axles (1 per axle)</li> <li>• Inner roll stop lever bracket pins (1 per pin)</li> <li>• Lift-Tite™ latch gas (dampening) spring (2 per spring)</li> </ul>	Resecure or replace if needed.	



## Maintenance and Lubrication Schedule

<b>1500 Cycles</b>	<p>Inspect platform fold axles and bearings for wear or damage and positive securement</p> <p>Remove pump module cover and inspect:</p> <ul style="list-style-type: none"> <li>• Hydraulic hoses, fittings and connections for wear or leaks</li> <li>• Harness cables, wires, terminals and connections for securement or damage</li> <li>• Control board, circuit breaker, power switch and lights for securement or damage</li> </ul>	<p>Replace damaged parts and resecure as needed. Apply Light Oil.</p> <p>Resecure, replace or correct as needed.</p>
<b>4500 Cycles</b>	<p style="border: 1px solid black; padding: 2px;"><b>Perform all procedures listed in previous sections also</b></p> <p>Inspect cotter pins on platform pivot pin (2)</p> <p>Hydraulic Fluid (Pump) - Check level. Note: Fluid should be changed if there is visible contamination. Inspect the hydraulic system (cylinder, hoses, fittings, seals, etc.) for leaks if fluid level is low.</p> <p>Inspect cylinders, fittings and hydraulic connections for wear, damage or leaks</p>	<p>Resecure, replace or correct as needed</p> <p>Use Braun 32840-QT hydraulic fluid (Exxon® Unis HVI 26). Do not mix with Dextron III or other hydraulic fluids. Check fluid level with platform lowered fully. Fill to maximum fluid level indicated on reservoir (specified on decal). Do not overfill. If fluid level decal is not present - measure 1-3/8" from the fill port to locate fluid level.</p> <p>Tighten, repair or replace if needed.</p>

## Maintenance and Lubrication Schedule

<b>4500 Cycles</b>	<b>Perform all procedures listed in previous section also</b>	
	Inspect outer barrier cylinder hose assembly (hose, fasteners, connections, etc.) for wear, damage or leakage (if equipped)	Tighten, repair or replace if needed.
	Inspect parallel arms, bushings and pivot pins for visible wear or damage	Replace if needed.
	Inspect parallel arm pivot pin mounting bolts (8)	Tighten or replace if needed.
	Inspect platform pivot pin, bushings and vertical arms for wear, damage and positive securement	Replace damaged parts and resecure as needed. Apply Light Grease during reassembly procedures.
	Inspect upper/lower fold arms, rotating pivot slide arms, slide support arms and associated pivot pins, bushings, and bearings for visible wear or damage	Replace if needed.
	Inspect gas springs (cylinders) for wear or damage, proper operation and positive securement	Tighten, replace or correct as needed
Inspect rotating pivot slide arm UHMW slide bearings (buttons)	Apply Door-Ease or replace if needed. See Lubrication Diagram.	

## Maintenance and Lubrication Schedule

<b>4500 Cycles</b>	Inspect vertical arm plastic covers  Inspect power cable  Mounting  Decals and Antiskid	Resecure or replace if needed.  Resecure, repair or replace if needed.  Check to see that the lift is securely anchored to the vehicle and there are no loose bolts, broken welds, or stress fractures.  Replace decals if worn, missing or illegible. Replace antiskid if worn or missing. See Decals and Antiskid section on pages 38-40.
<b>Consecutive 750 Cycle Intervals</b>	Repeat all previously listed inspection, lubrication and maintenance procedures at 750 cycle intervals.	

## **Limited Warranty**

### **WARRANTY COVERAGE AND WARRANTY COVERAGE TIME PERIODS**

The Braun Corporation (“Braun”) warranty covers certain parts of this wheelchair lift for three (3) years or 10,000 cycles and the cost of labor to repair or replace those parts for one (1) year or 3,000 cycles. If The Braun Corporation receives the warranty registration card within 20 days after the lift is put into service, the warranty labor coverage will increase from one (1) year or 3,000 cycles to three (3) years or 10,000 cycles. In addition, providing the warranty registration card is returned as noted above, the following lift’s power train parts are warrantied for five (5) years or 15,000 cycles: Cable, Cylinder, Flow Control, Gear Box, Motor, Pump, Hydraulic Hose and Fittings. This limited warranty covers substantial defects in materials and workmanship of the lift, provided that the lift is operated and maintained properly and in conformity with the owner’s manual. The warranty period begins on the date that the product is delivered to the first retail purchaser by an independent, authorized dealer of Braun, or, if the dealer places the product into any type of service prior to retail sale, on the date the dealer first places the product in such service. This limited warranty applies only to the first purchaser. It may not be transferred.

### **WHAT BRAUN WILL DO TO CORRECT PROBLEMS**

In the event that a substantial defect in material or workmanship, attributable to Braun, is found to exist during the first year of warranty coverage, it will be repaired or replaced, at Braun’s option, without charge for parts or labor to the owner, in accordance with the terms, conditions and limitations of this limited warranty. If the substantial defect in material or workmanship, attributable to Braun, is found to exist during the second or third year of warranty coverage, it will be repaired or replaced, at Braun’s option, without charge to the owner for parts, only, in accordance with the terms, conditions and limitations of this limited warranty.

## **Limited Warranty**

Providing the warranty card is returned within 20 days as outlined above, the labor warranty period will be extended by two years of coverage in accordance with the terms, conditions, and limitations of this limited warranty. In addition, if a substantial defect in material or workmanship, attributable to Braun, is found to exist during the fourth or fifth year of warranty coverage to the following lift's power train parts: Cable, Cylinder, Flow Control, Gear Box, Motor, Pump, Hydraulic Hose and Fittings, it will be repaired or replaced, at Braun's option, without charge to the owner for parts, only, in accordance with the terms, conditions and limitations of this limited warranty. The cost of labor for repair or replacement at any time after the warranty coverage detailed above is the sole responsibility of the owner.

Braun's obligation to repair or replace defective materials or workmanship is the sole obligation of Braun under this limited warranty. Braun reserves the right to use new or remanufactured parts of similar quality to complete any work, and to make parts and design changes from time to time without notice to anyone. Braun reserves the right to make changes in the design or material of its products without incurring any obligation to incorporate such changes in any previously manufactured product. Braun makes no warranty as to the future performance of this product, and this limited warranty is not intended to extend to the future performance of the product. In addition, the owner's obligation to notify Braun, or one of its authorized, independent dealers, of a claimed defect does not modify any obligation placed on the owner to contact Braun directly when attempting to pursue remedies under state or federal law.

## **Limited Warranty**

### **LIMITATIONS, EXCLUSIONS AND DISCLAIMER OF IMPLIED WARRANTIES**

**ANY IMPLIED WARRANTY THAT IS FOUND TO ARISE BY WAY OF STATE OR FEDERAL LAW, INCLUDING ANY IMPLIED WARRANTY OF MERCHANTABILITY OR ANY IMPLIED WARRANTY OF FITNESS, IS LIMITED IN DURATION TO THE TERMS OF THIS LIMITED WARRANTY AND IS LIMITED IN SCOPE OF COVERAGE TO THE SCOPE OF COVERAGE OF THIS LIMITED WARRANTY.** Braun disclaims any express or implied warranty, including any implied warranty of fitness or merchantability, on items excluded from coverage as set forth in this limited warranty. Braun makes no warranty of any nature beyond that contained in this limited warranty. No one has authority to enlarge, amend or modify this limited warranty, and Braun does not authorize anyone to create any other obligation for it regarding this product. Braun is not responsible for any representation, promise or warranty made by any independent dealer or other person beyond what is expressly stated in this limited warranty. Any selling or servicing dealer is not Braun's agent, but an independent entity.

**BRAUN SHALL NOT BE LIABLE FOR ANY INCIDENTAL OR CONSEQUENTIAL DAMAGES THAT MAY RESULT FROM BREACH OF THIS LIMITED WARRANTY OR ANY IMPLIED WARRANTY. THIS EXCLUSION OF CONSEQUENTIAL AND INCIDENTAL DAMAGES SHALL BE INDEPENDENT OF ANY FAILURE OF THE ESSENTIAL PURPOSE OF ANY WARRANTY, AND THIS EXCLUSION SHALL SURVIVE ANY DETERMINATION THAT THIS LIMITED WARRANTY OR ANY IMPLIED WARRANTY HAS FAILED OF ITS ESSENTIAL PURPOSE.** This warranty does not cover, and in no event shall Braun be liable for towing charges, travel, lodging, or any other expense incurred due to the loss of use of the product or other reason.

## **Limited Warranty**

Some states do not allow limitations on how long an implied warranty lasts, or the exclusion or limitation of incidental or consequential damages, so the above limitations or exclusions may not apply to you.

### **HOW TO GET SERVICE**

To obtain warranty service the owner must do all of the following:

1. Notify an authorized service center, of the claimed defect attributable to Braun, within the warranty coverage period designated above
2. Provide the notification mentioned in (1), above, within ten (10) days of when the owner discovered, or should have discovered, the claimed defect
3. Promptly schedule an appointment with and take the product to an authorized service center for service.
4. Pay any transportation costs and all expenses associated with obtaining warranty service.

Since Braun does not control the scheduling of service work at the independent dealerships you may encounter some delay in scheduling or completion of work. If you need assistance you may contact Braun, at 631 West 11th Street, Winamac, Indiana 46996; 1-800-THE-LIFT, (843-5438).

If two (2) or more service attempts have been made to correct any covered defect that you believe impairs the value, use or safety of the product, or if it has taken longer than thirty (30) days for repairs to be completed, you must, to the extent permitted by law, notify Braun directly, in writing, at the above address, of the unsuccessful repair(s) of the alleged defect(s) so that Braun can become directly involved in providing service pursuant to the terms of this limited warranty.

## **Limited Warranty**

### **WHAT IS NOT COVERED**

This Limited Warranty does not cover any of the following: defects in materials, components or parts of the product not attributable to Braun, any material, component or part of the product that is warranted by another entity (Note: the written warranty provided by the manufacturer of the material, component or part is the direct responsibility of that manufacturer); items that are added or changed after the product leaves Braun's possession; additional items installed at any dealership, or other place of business, or by any other party, other than Braun; normal wear, tear, usage, maintenance, service, periodic adjustments, the effects of condensation or moisture from condensation; mold or any damage caused by mold; imperfections that do not affect the product for its intended purpose; items that are working as designed but that you are unhappy with; problems related to mis-operation, misuse, mishandling, neglect or abuse, including failure to maintain the product in accordance with the owner's manual, or other routine maintenance such as inspections, lubricating, adjustments, tightening of screws, sealing, wheel alignments or rotating tires; damage due to accident or collision, including any acts of weather or damage or corrosion due to the environment; theft, vandalism, fire, or other intervening acts not attributable to Braun; damage resulting from tire wear or tire failure; defacing, scratches, dents or chips on any interior or exterior surface of the product, including those caused by rocks or other road hazards, damage caused by off road use, overloading or alteration of the product, or any of its components or parts;

Defects and/or damage to interior and exterior surfaces and other appearance items may occur at the factory or when the product is in transit. These items are usually detected and corrected at the factory or by a dealer prior to delivery to the purchaser. You must inspect the product for this type of damage when you take delivery. If you find any such defect or damage you must notify the selling dealer, or Braun, at the time



## **Limited Warranty**

of delivery to have these items covered by this limited warranty and to have work performed on the items at no cost to you as provided by this limited warranty.

### **EVENTS DISCHARGING BRAUN FROM OBLIGATION UNDER WARRANTY**

The following shall completely discharge Braun from any express or implied warranty obligation to repair or replace anything and void this warranty: misuse, neglect, collision, accidents, failure to provide routine maintenance (See Owner's Manual), unauthorized alteration, off road use, Acts of Nature, damage from weather or the environment, theft, vandalism, tampering, fire, explosions, overloading the product and odometer tampering.

### **LEGAL REMEDIES**

Any action to enforce any portion of this limited warranty, or any implied warranty, must be commenced within six (6) months after expiration of the warranty coverage period designated above or the action will be barred because of the passage of time. Any performance of repairs shall not suspend this limitation period from expiring. Any performance of repairs after the warranty coverage period has expired, or performance of repairs regarding any thing excluded from coverage under this limited warranty shall be considered "good will" repairs, and they will not alter the terms of this limited warranty, or extend the warranty coverage period or the filing limitation period in this paragraph. In addition, since it is reasonable to expect that the product will need some service during the warranty period; this warranty does not extend to future performance. It only sets forth what Braun will do and does not guarantee anything about the product for any time period.

## **Limited Warranty**

Nothing in this warranty, or any action of Braun, or any agent of Braun, shall be interpreted as an extension of any warranty period or the filing limitation period in this paragraph. Some states do not allow a reduction in the statute of limitations, so this reduction may not apply to you.

### **WARRANTY REGISTRATION and MISCELLANEOUS**

Your warranty registration records should be completed and delivered to the appropriate companies, including the Braun Delivery Checklist & Warranty form. That form must be returned to Braun within twenty (20) days of purchase. The Braun warranty will not be registered unless this warranty registration is completed and received by Braun. Failure to file this warranty registration with Braun will not affect your rights under this limited warranty as long as you can present proof of purchase, but it can cause delays in obtaining the benefits of this limited warranty, and it changes the start date of the warranty to the date of final assembly of the product by Braun.

Braun agrees to repair or replace any of its factory installed parts found to have substantial defects within the appropriate warranty period designated above, provided that the repair is authorized by Braun and carried out by an authorized service center (a Braun labor schedule determines the cost allowance for repairs). Braun will not honor any warranty claim for repairs or replacement of parts unless the claim is submitted with the appropriate paperwork, and the work is completed by an independent, factory authorized service center. The appropriate paperwork can be obtained by written or phone contact with Braun at the contact information in this warranty.

## **Limited Warranty**

Braun reserves the right to designate where any warranty work can be performed. Braun also reserves the right to examine any defective workmanship or part prior to giving any authorization for warranty work. Braun's return authorization procedure must be adhered to in order to process any warranty claims.

THIS WARRANTY GIVES YOU SPECIFIC LEGAL RIGHTS. YOU MAY ALSO HAVE OTHER RIGHTS THAT VARY FROM STATE TO STATE.

**"Providing Access to the World"®**



**Over 300 Braun  
Dealers Worldwide**

# Operator's Manual

## ***NL Series***

### Public Use Wheelchair Lifts

**Patent #5,261,779**

**Patent #6,599,079**

**Patent #7,422,408**

**Patent #6,065,924**

**Patent #6,692,217**

**Patent #7,444,995**

**Patent #6,238,169**

**Patent #6,739,824**

**Patent #7,509,187**

**Patent #6,464,447**

**Patent #7,306,422**

**Patent #7,530,226**

**Patents Pending**

**Braun NL Series**

**BRAUN**  
**MILLENNIUM**  
**SERIES**

All illustrations, descriptions and specifications in this manual are based on the latest product information available at the time of publication. The Braun Corporation reserves the right to make changes at any time without notice.

30651 Rev. H December 2009

© The Braun Corporation