



FUJIMEDIC
Made in Japan

User Manual
FJL50

www.fujimedic.com

TABLE OF CONTENTS

 INTRO	Dimensions	2
	Contents	3
 CHAIR	Move & Clearance	4
	Components	5
	Massage Points	6
	Specifications	7
 MASSAGE	Interface	8-11
	Pre-Programed Massage	12-17
	Demo	18-19
	Custom Massage	20-24
	Spot Massage	25-27
	Settings	28-33
 CARE	Safety	34-36
	Grounding Instruction	36
	Product Cleaning	37
	Warranty	37

DIMENSIONS

First, let's get your chair inside.

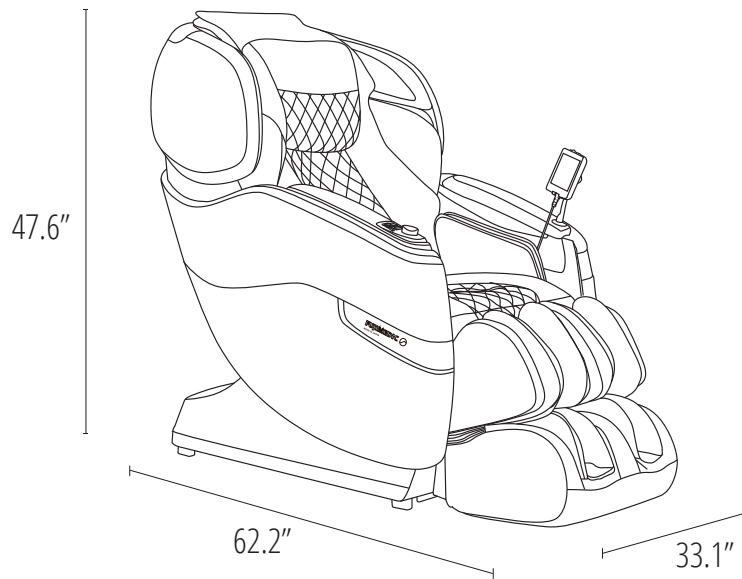

Box 1

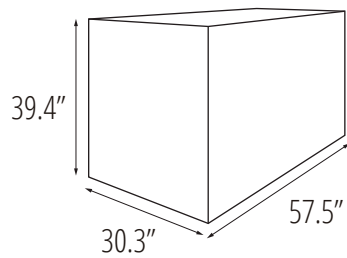

Base & Backrest

Box 2

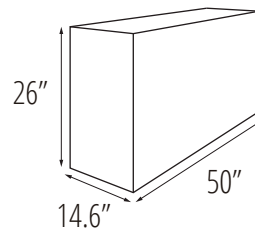

Side Panels

Box 3

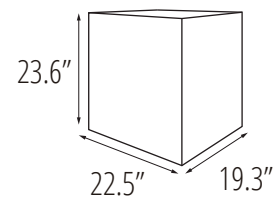

Footrest

CONTENTS

Everything you need for a relaxing experience.



User Manual



Installation Manual



Warranty Postcard

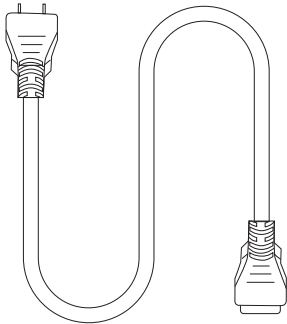

Power Cord

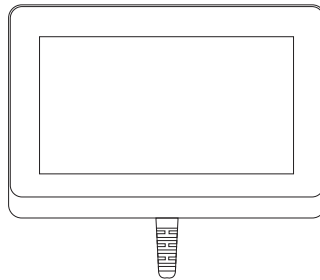

Wired Touch-Pad

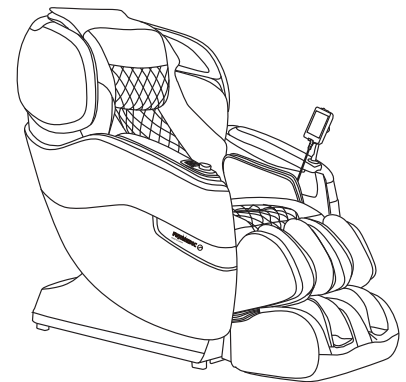

FJL50 Massage Chair

Move & Clearance

A few simple steps to find the best place for your new chair.

HOW TO MOVE

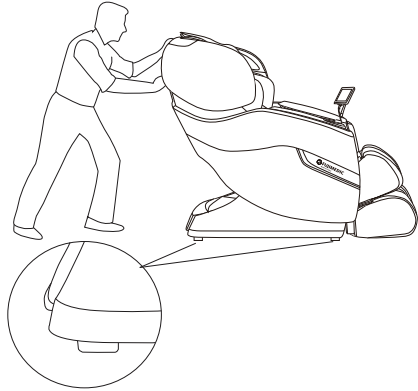

Move with a slight pull or push
Caution: If you roll the chair on wood floor, marks may be left

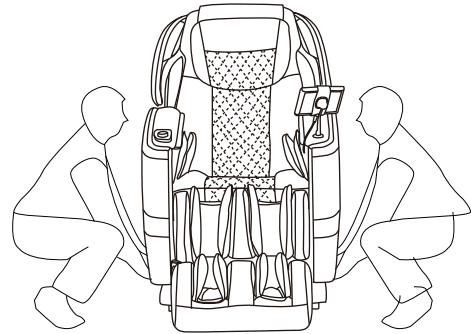

Two people are needed to lift the chair

CLEARANCE

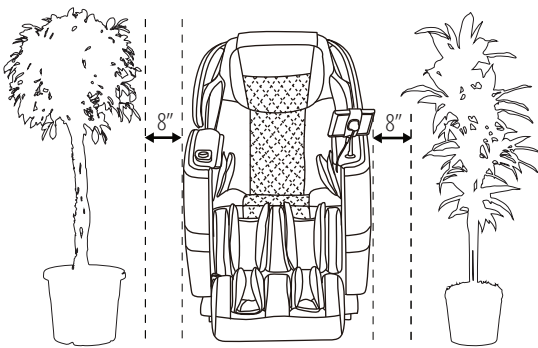

Reserve space on left and right

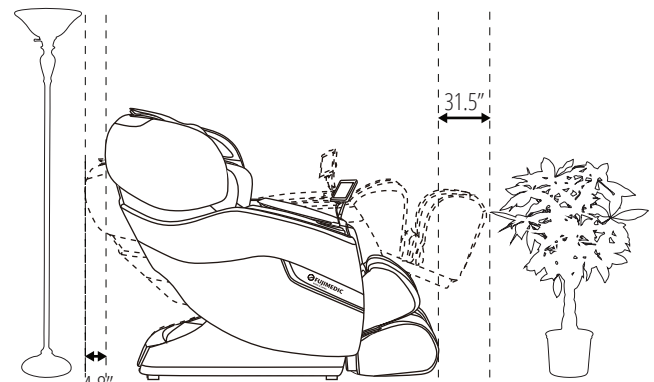

Reserve space on the front and back

CHAIR COMPONENTS

Some of your chair's most important features.

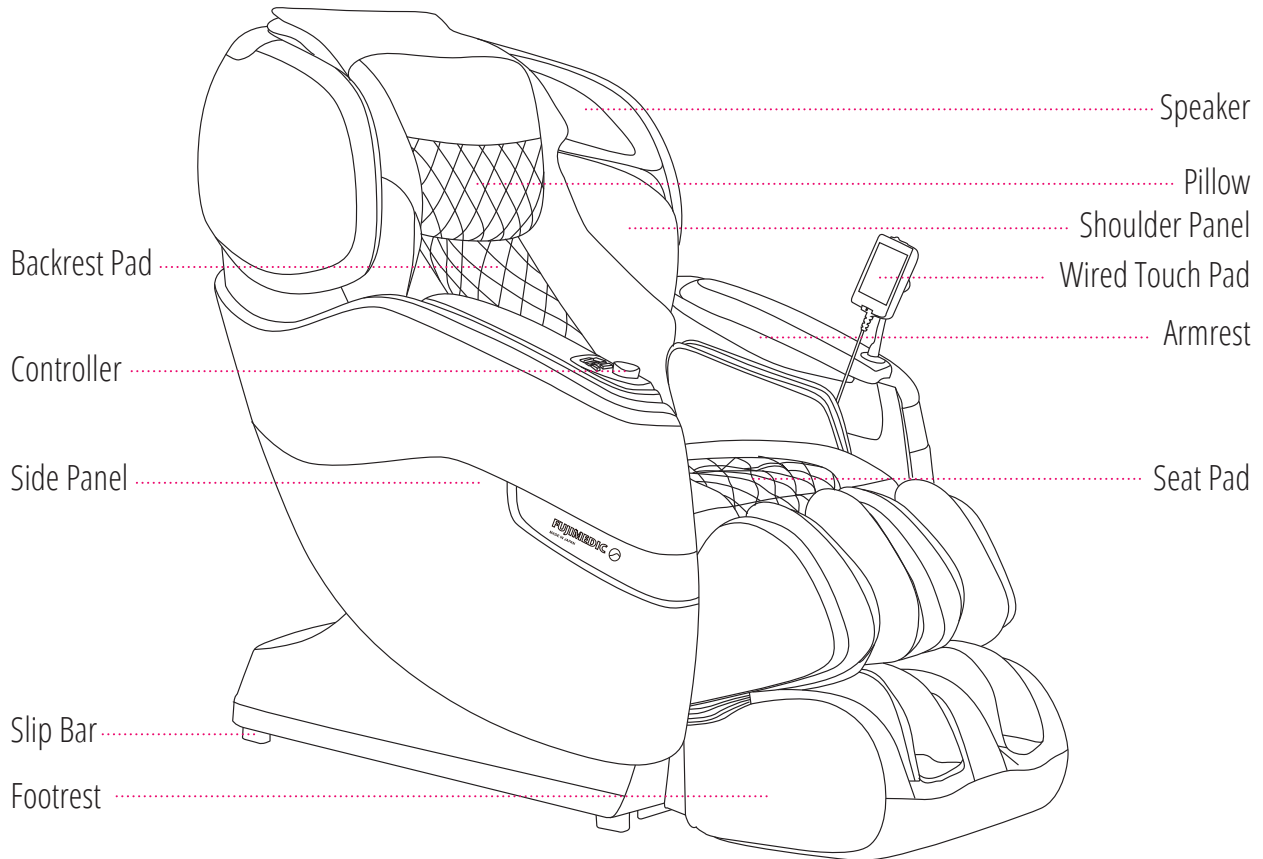

Note: The speaker will only operate when the massage chair is in operation



To play music using your massage chair's speakers please connect your smartphone, tablet, or other electronic device to your chair using bluetooth.

CHAIR SPECIFICATIONS

A few important facts about your massage chair.

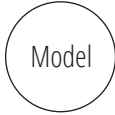

Model No.
FJL50

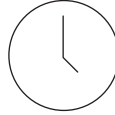

Max Massage Time
30 minutes

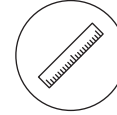

Dimensions (L x W x H)
Chair dimension: 62.2" x 33.1" x 47.6"
Reclined dimension: 77.2" x 33.1" x 41.3"



Shipping Weight
Gross weight: 321.2lbs
Net weight: 275lbs

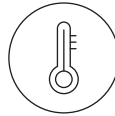

Usage Condition
Environment temperature: 10°C-40°C
Contrasting humidity: 30-85RH

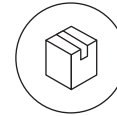

Storage Condition
Storage temperature: -20°C-60°C
Storage humidity level: 30-85RH

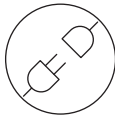

Power Consumption
200W



Rated Voltage
110 - 120V



Rated Frequency
60Hz



Power of Speakers
14W (2 sides)



Length of Wiring
Controller wiring 27.6"
Power supply wiring 70.9"



Safety Feature
Equipped with overheating and power surge detectors safety feature

WIRED TOUCH-PAD INTERFACE

We have designed your massage chair's tablet controller with a user-friendly interface to make using your chair even easier.

Home Screen

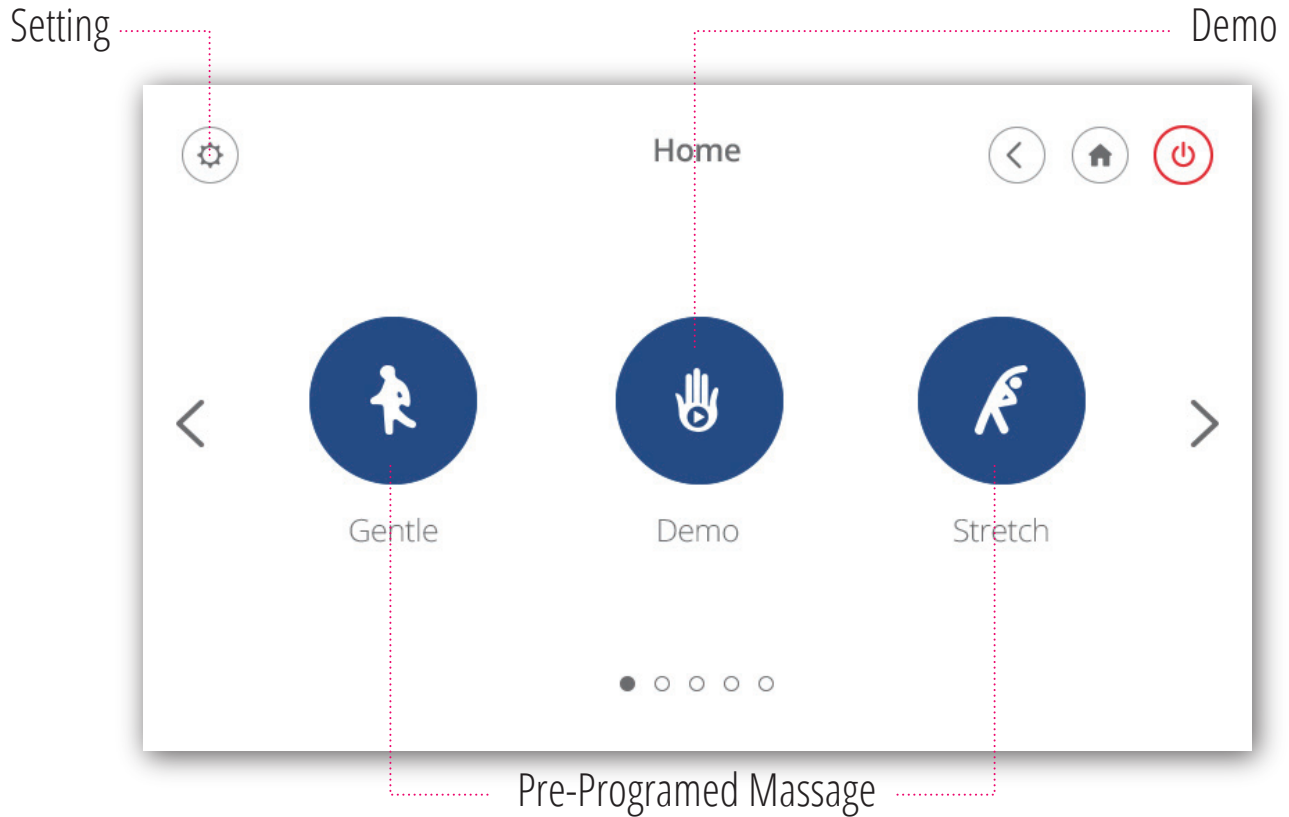

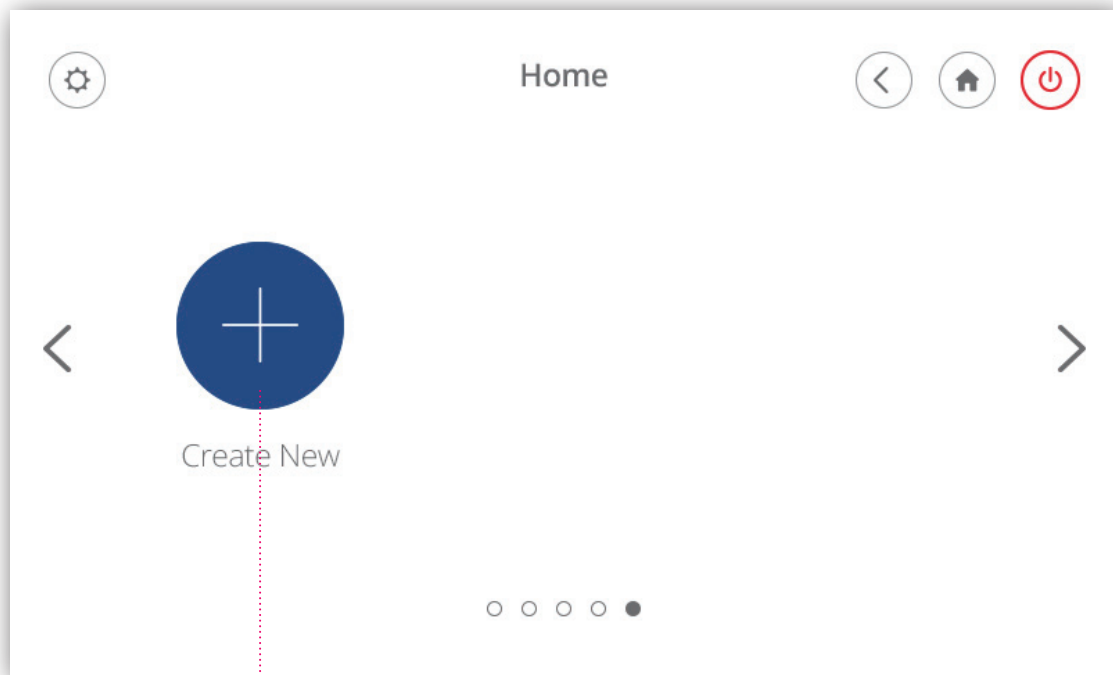

Create New Program

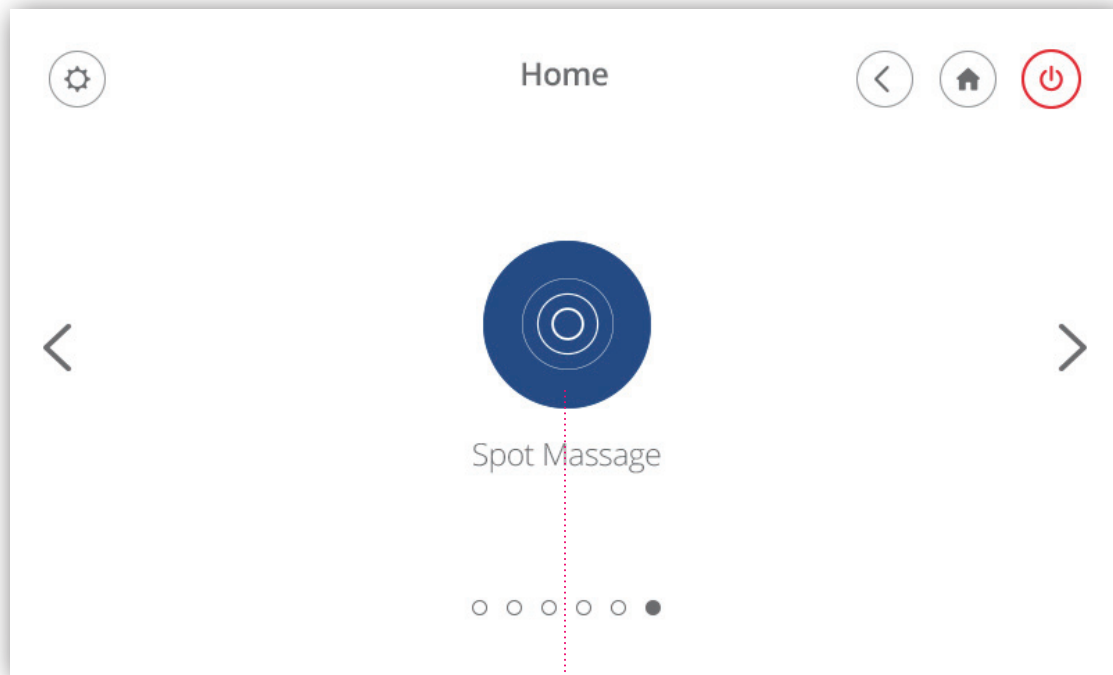

Spot Message

Massage Controls

Adjust Strength

Name of Program

Time left

Adjust

Recline

Light

Gentle min

Power

4D

Air Intensity

Heat

Sole Rollers

Foot Roller

Body Heat/
Back Heat/
Leg Heat

Light Color Variation

Adjust Chair Angle

PRE-PROGRAMMED MESSAGE

We have designed your chair with multiple massage options for your changing needs. Follow these simple instructions to begin a new pre-programmed massage.

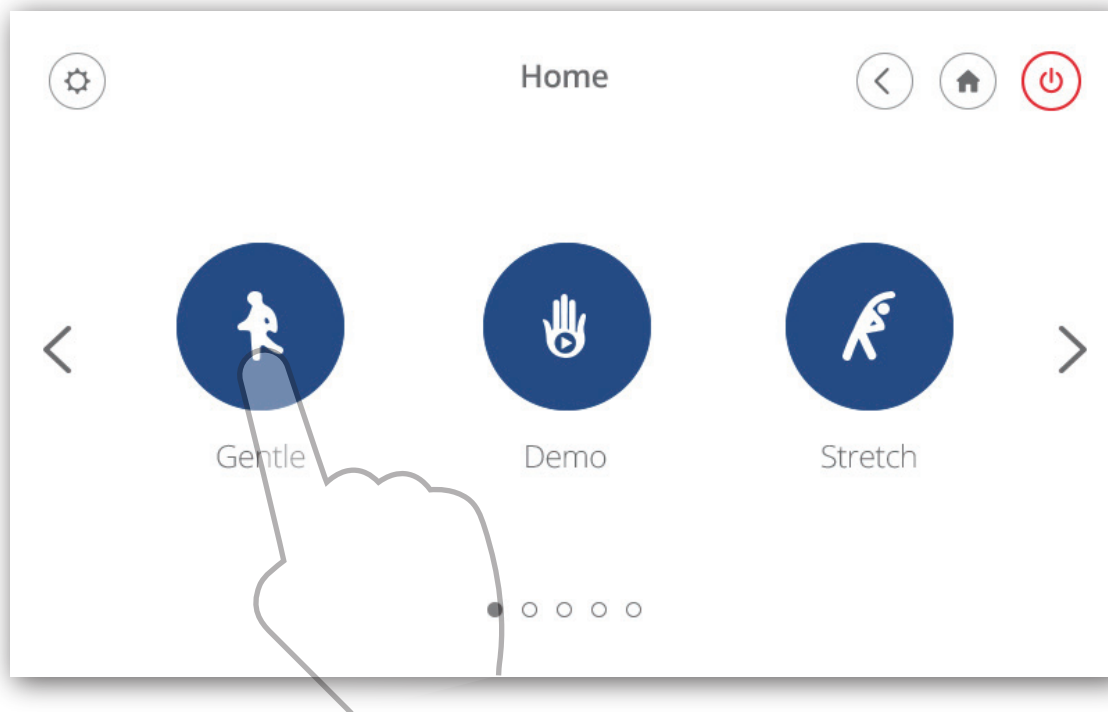

Choose 1 of our 11 pre-programmed massages
(Gentle, Stretch, Joint Care, Spine Care, Relax, Vigorous, Swedish, Thai, Japanese, Chinese, Balinese)

Pre-Programmed Massage Interface

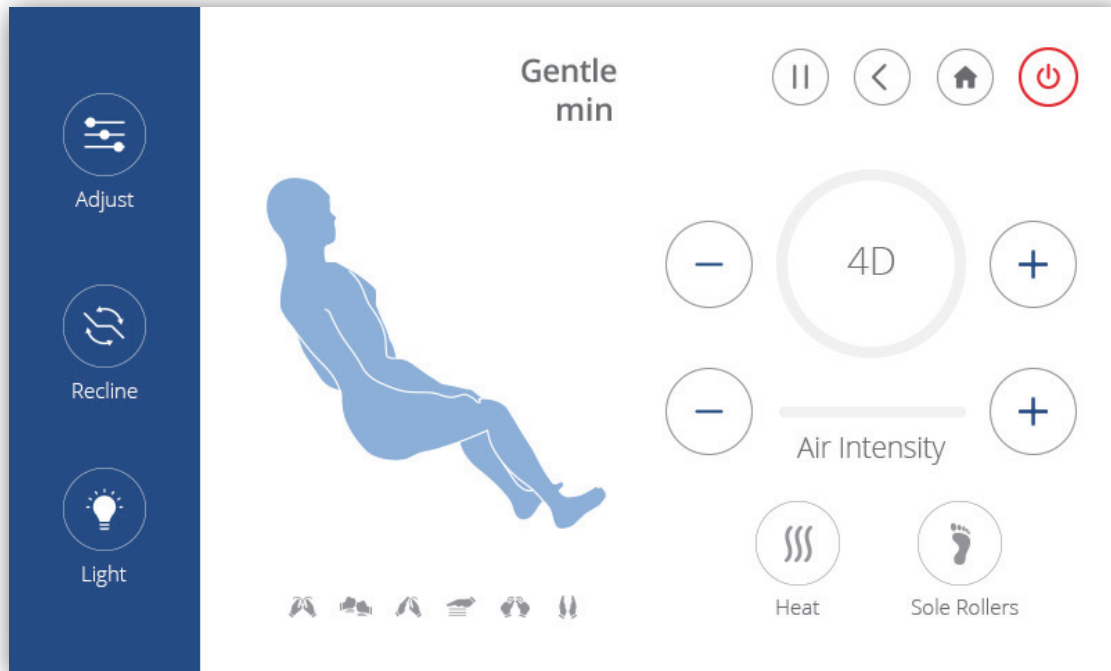

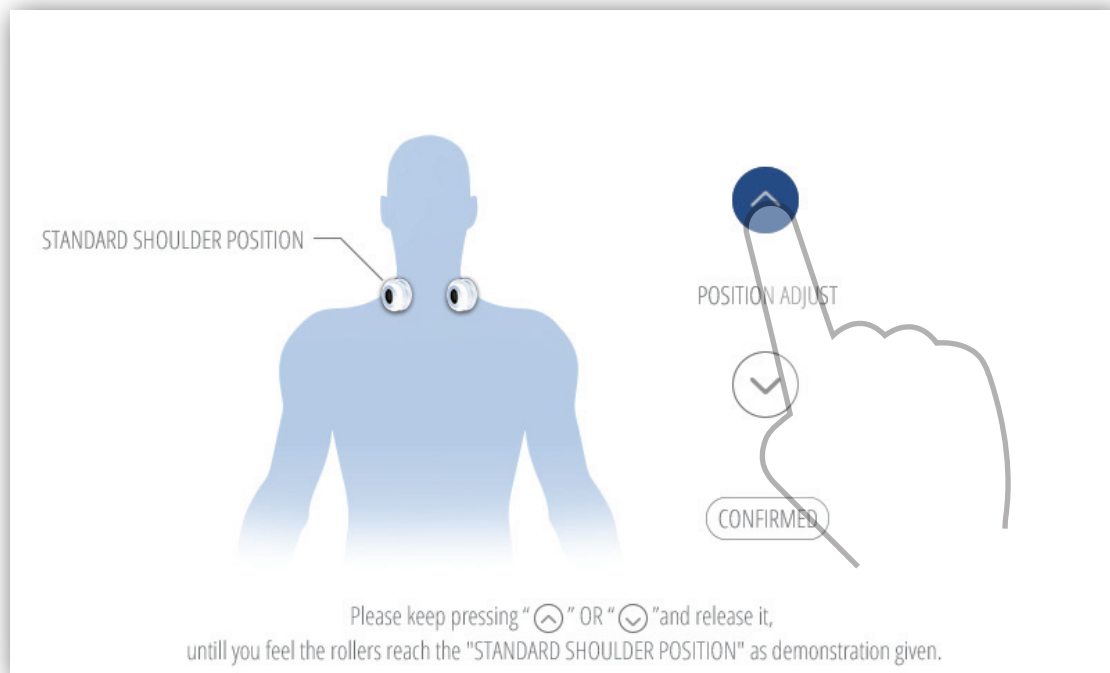

Using the arrows, you can adjust the standard shoulder position

Adjust Massage Strength Interface

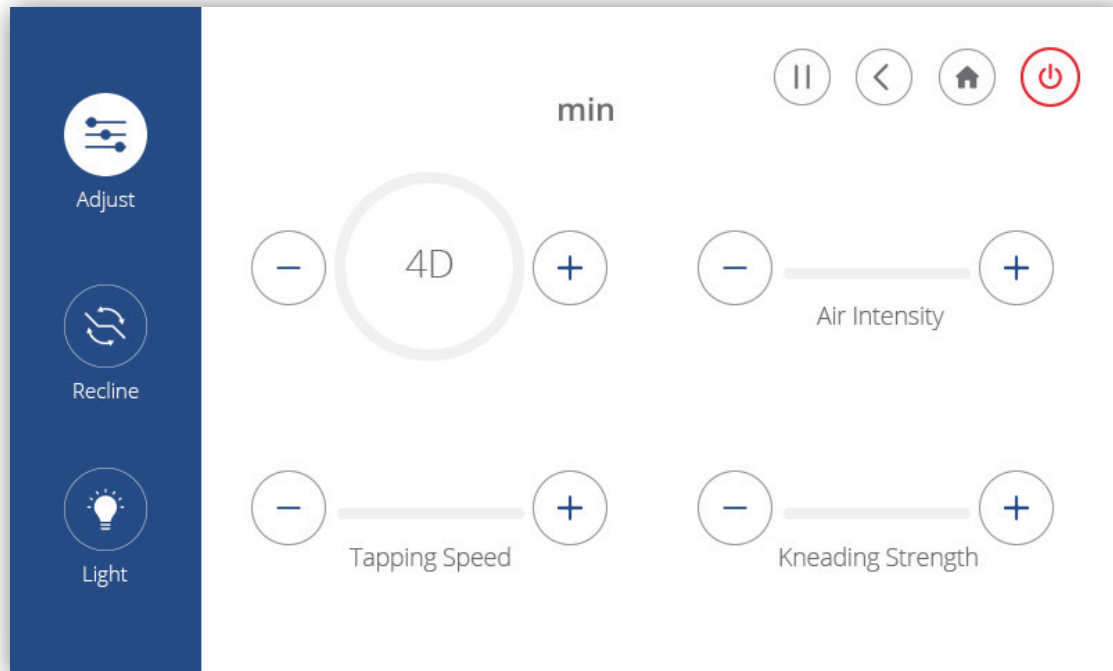

In this interface, you can adjust massage 4D strength, tapping speed, kneading strength and air intensity

Adjust Chair Angle Interface



Adjust your chair quickly by choosing one of the three preset seating positions. You can also press and hold the arrows to adjust parts of the chair independently

Change the Light Interface

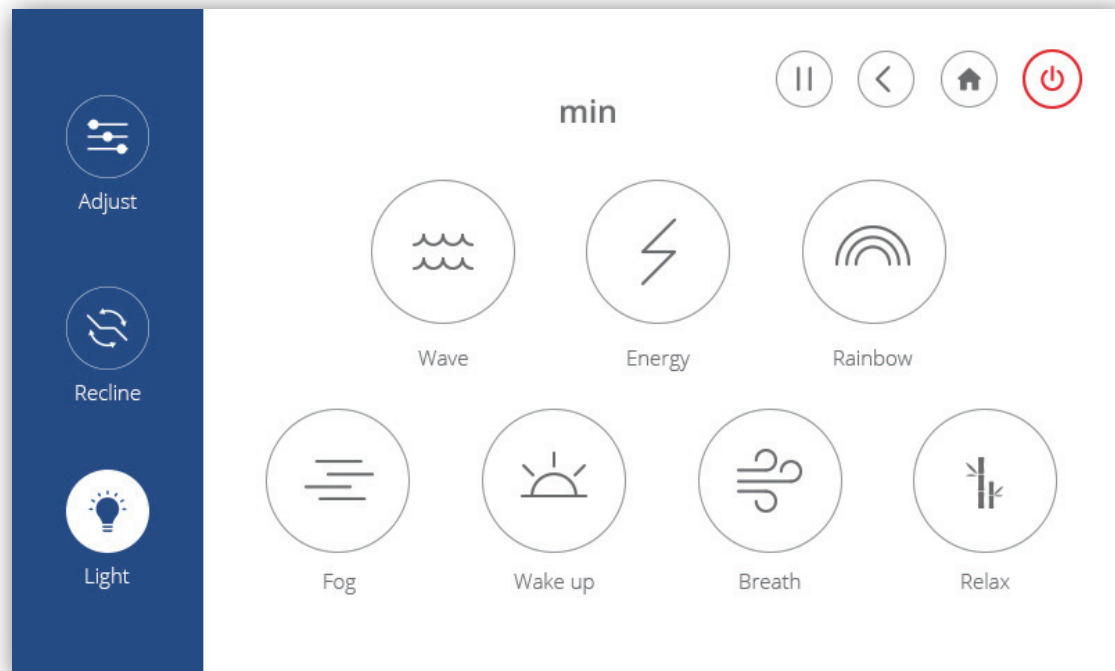

Choose 1 of the 7 types of LED light patterns

DEMO

To give you a quick glimpse of what your chair can do, we have created a demo module.

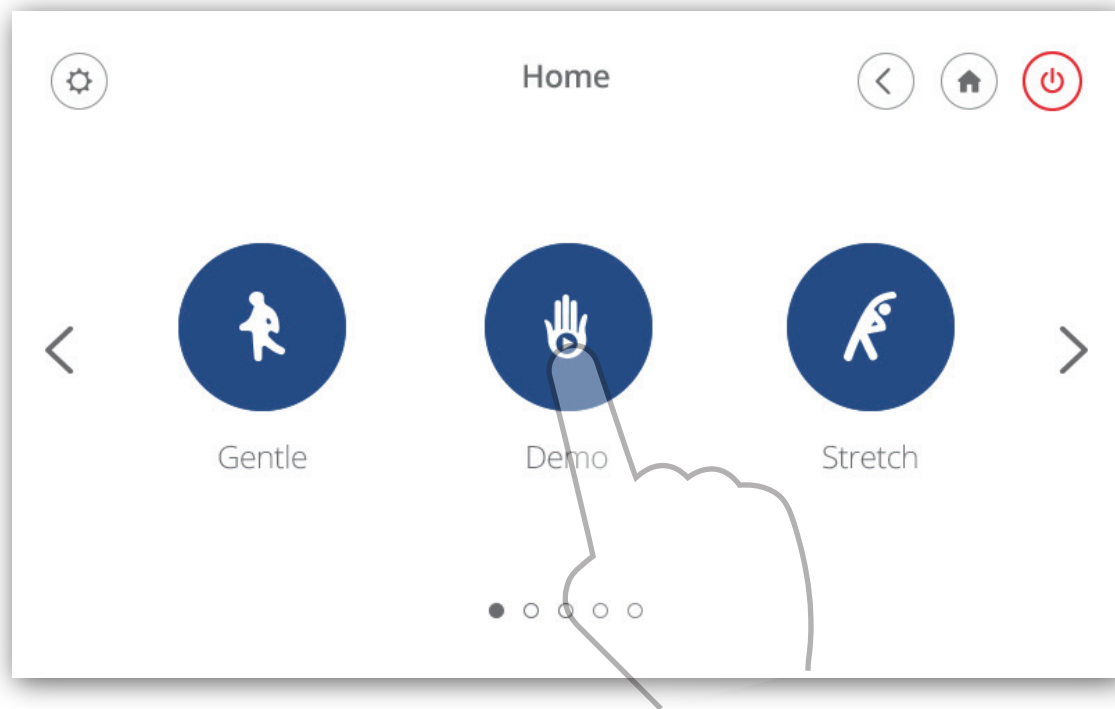

Choose the "Demo" icon to begin demo program

Demo Interface

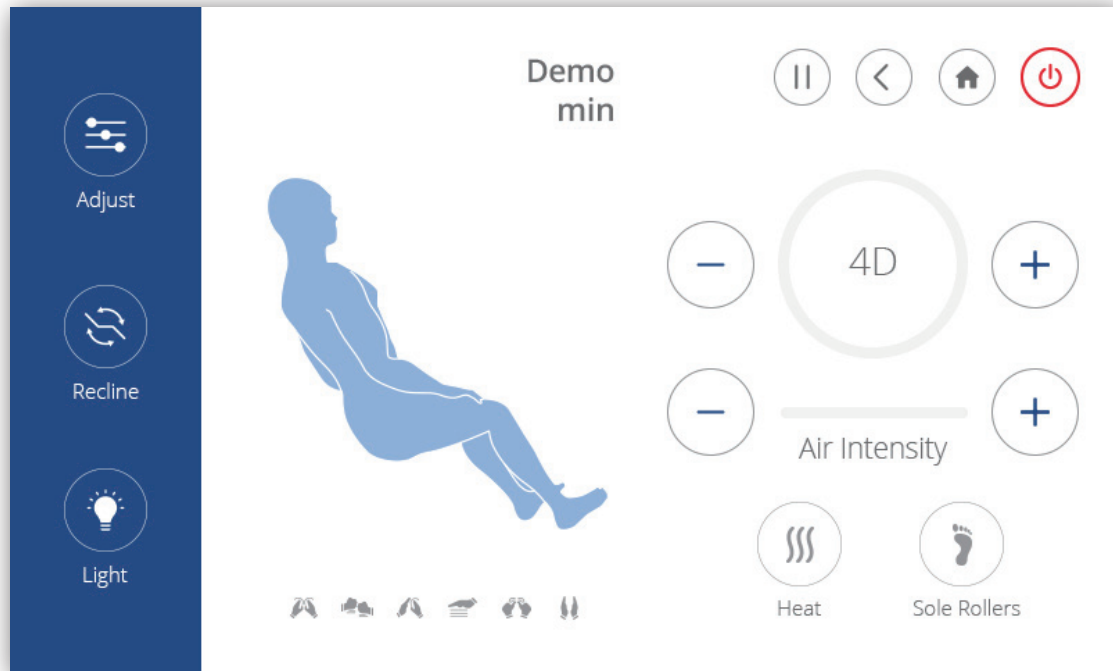

CUSTOM MESSAGE

Every body is different. That's why we've given you the option to customize your message to meet your specific needs. Follow these simple instructions to create a new custom message. You can create up to 3 custom programs. To delete a custom message program, press and hold that icon and choose the "x".

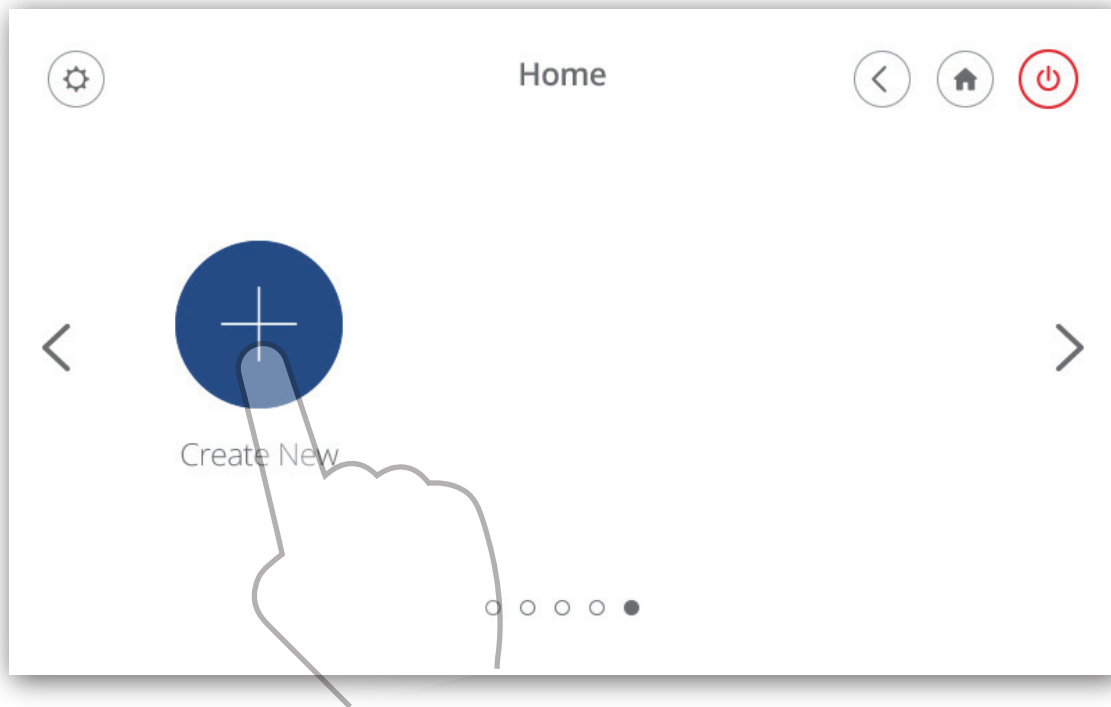

Choose the "Create New" icon to begin creating your message program

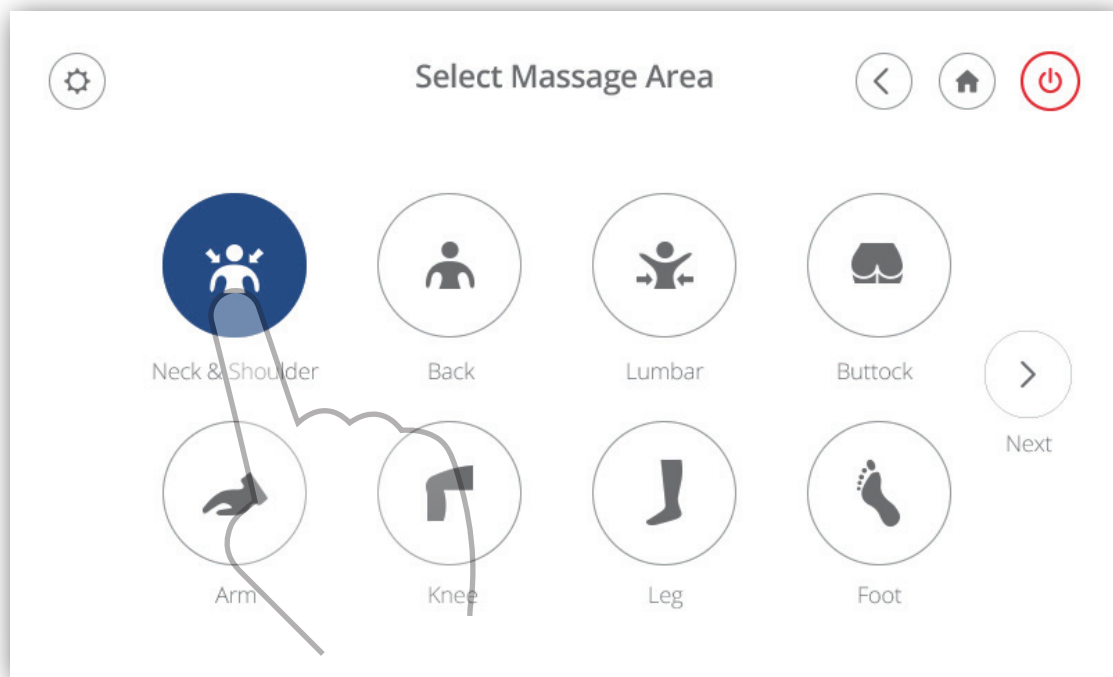

Select the areas you need massaged

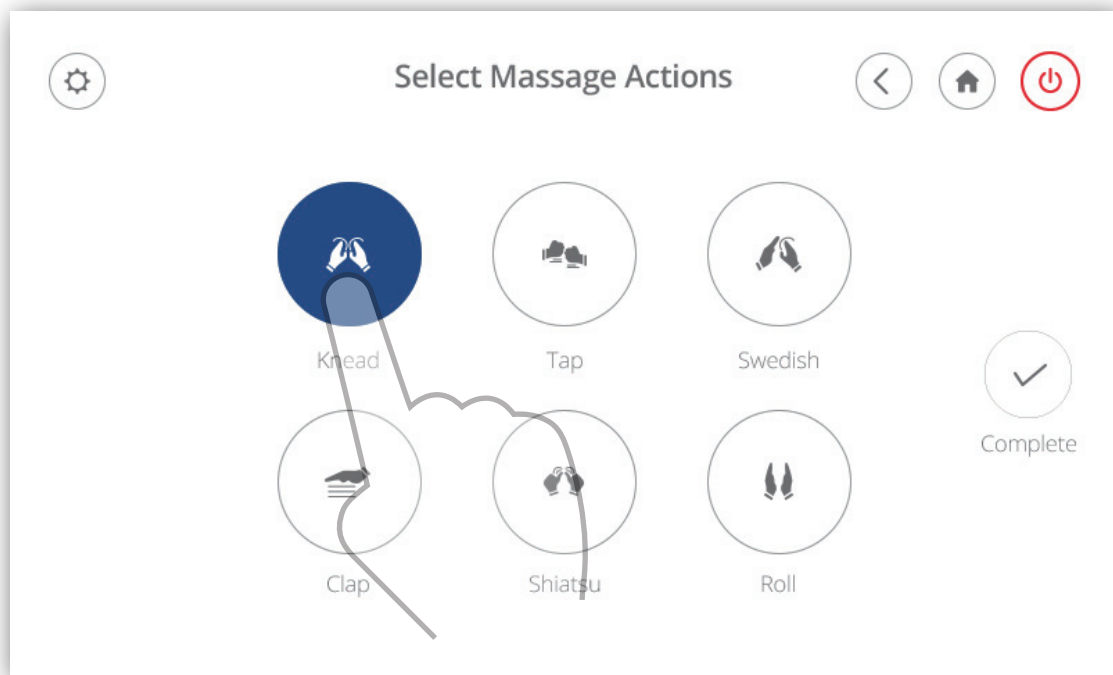

Select which massage actions you would like. The knead, tap, clap, and shiatsu massages can be combined with swedish or roll

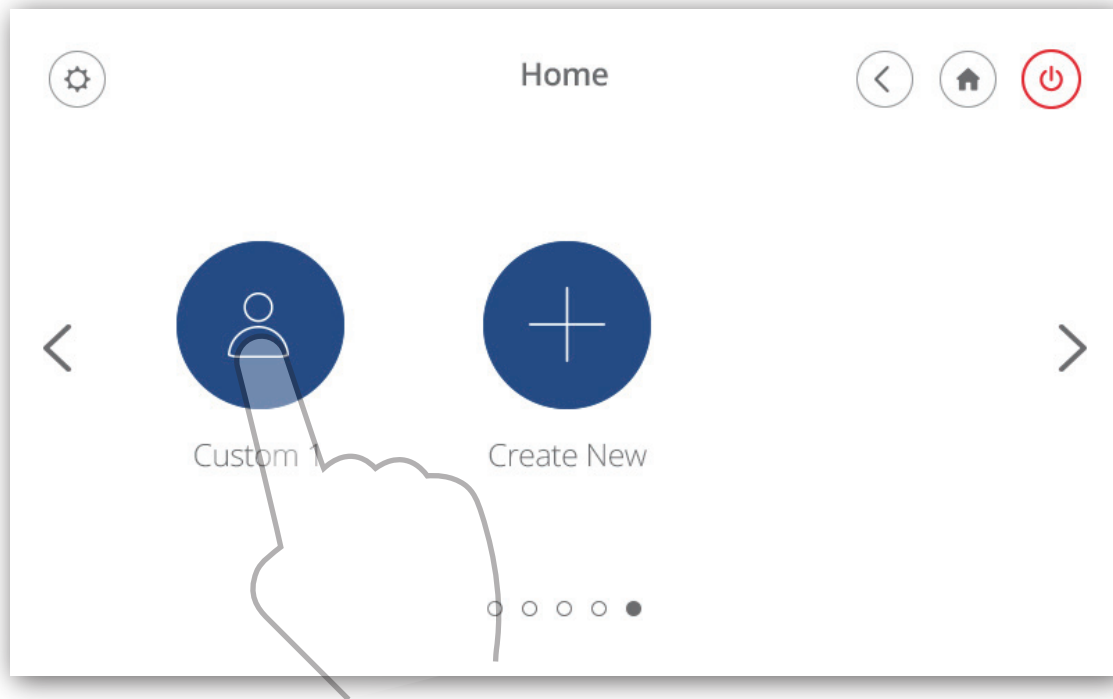

Choose the "Custom 1" icon to start your program

Custom Interface

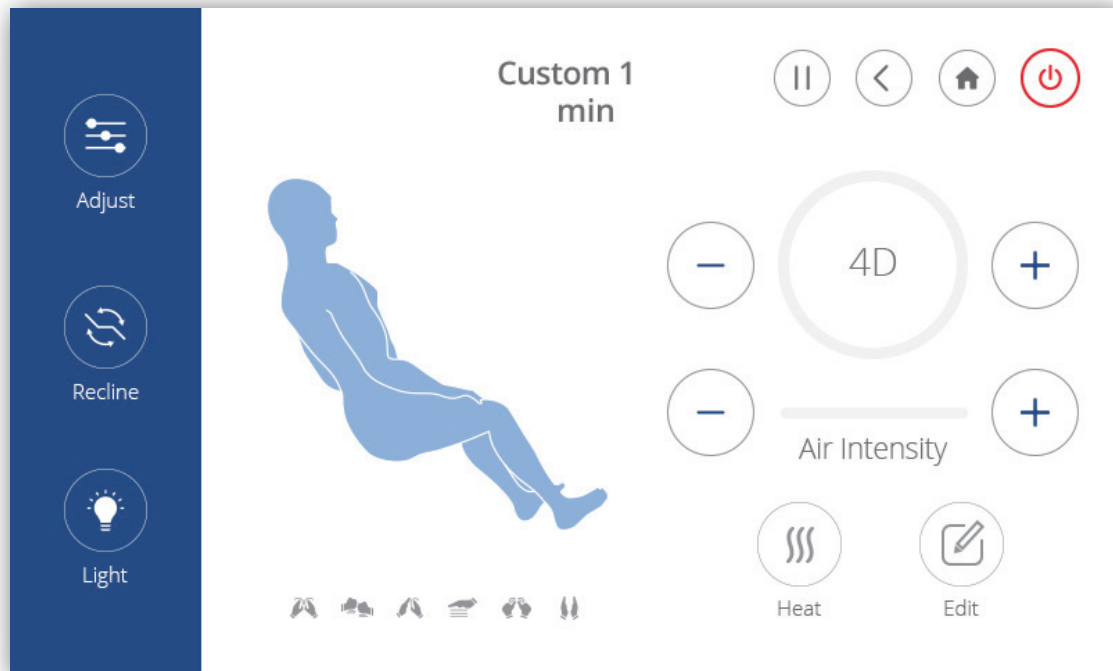

SPOT MESSAGE

This is a fixed message area and actions program.

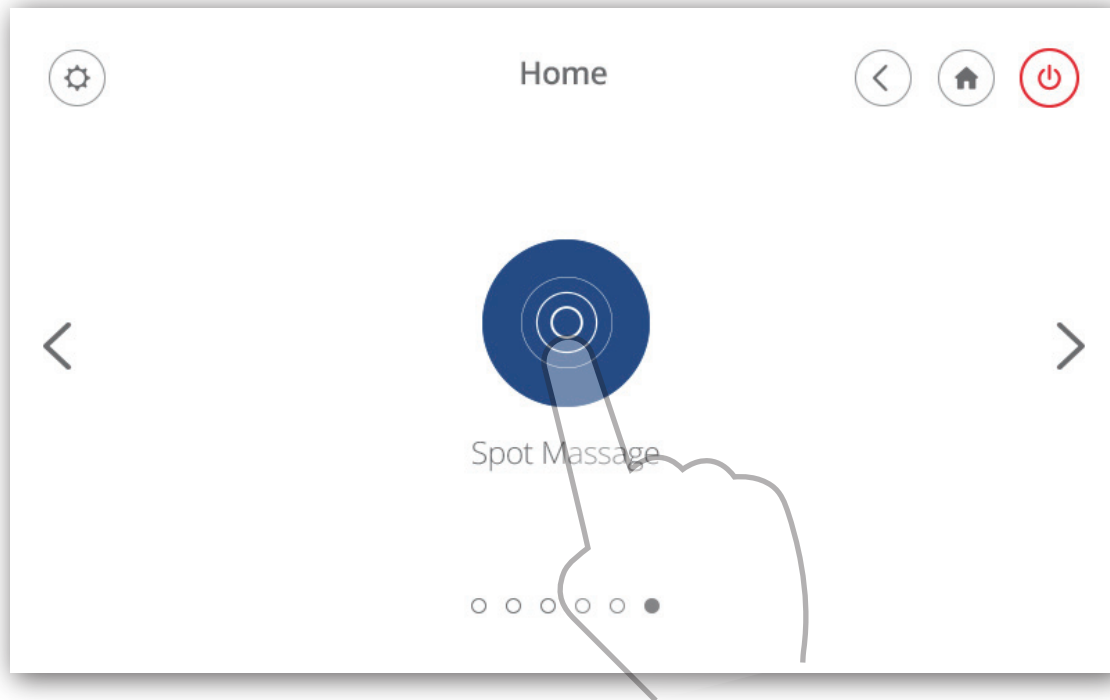

Choose the "Spot Message" button to take you to the Spot Message page

Spot Massage Interface 1

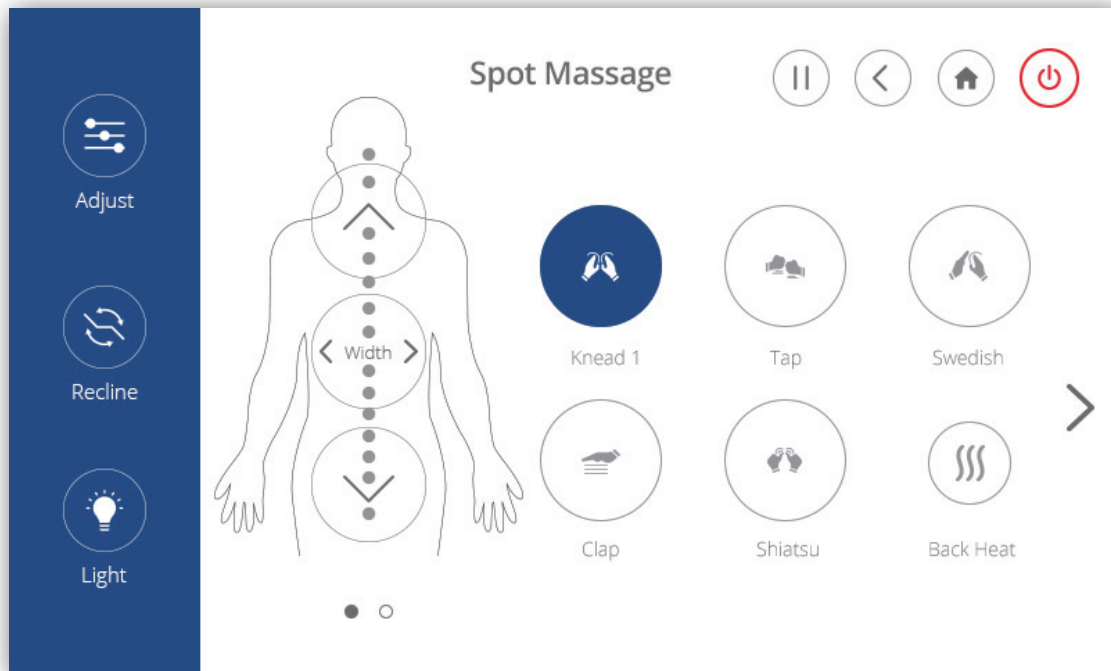

Spot Massage Interface 2

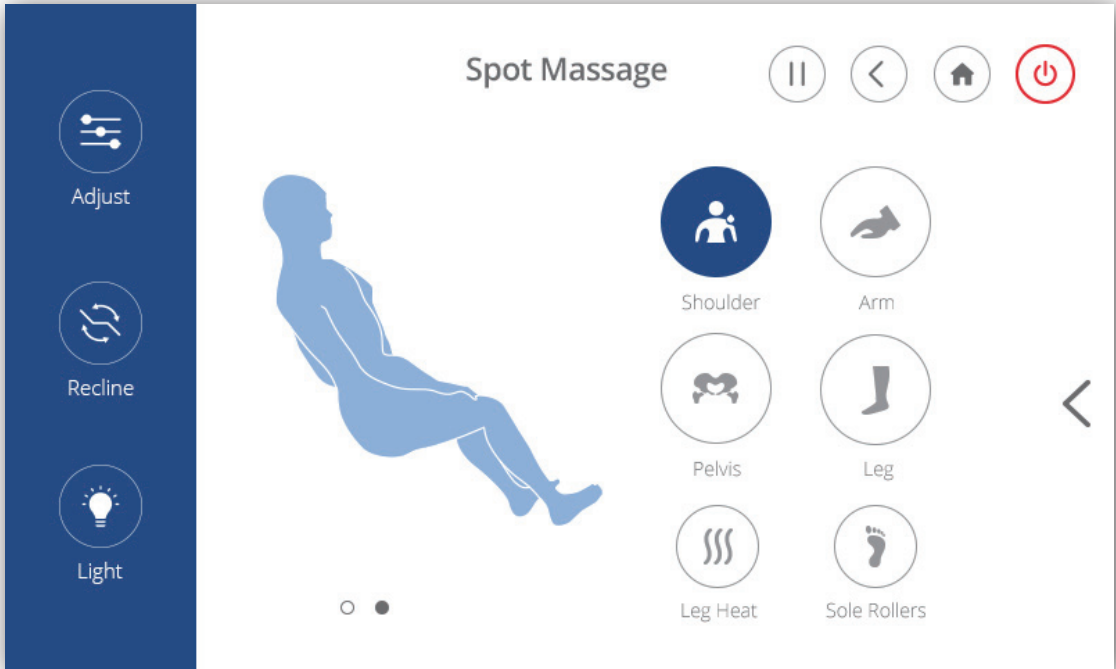

SETTINGS

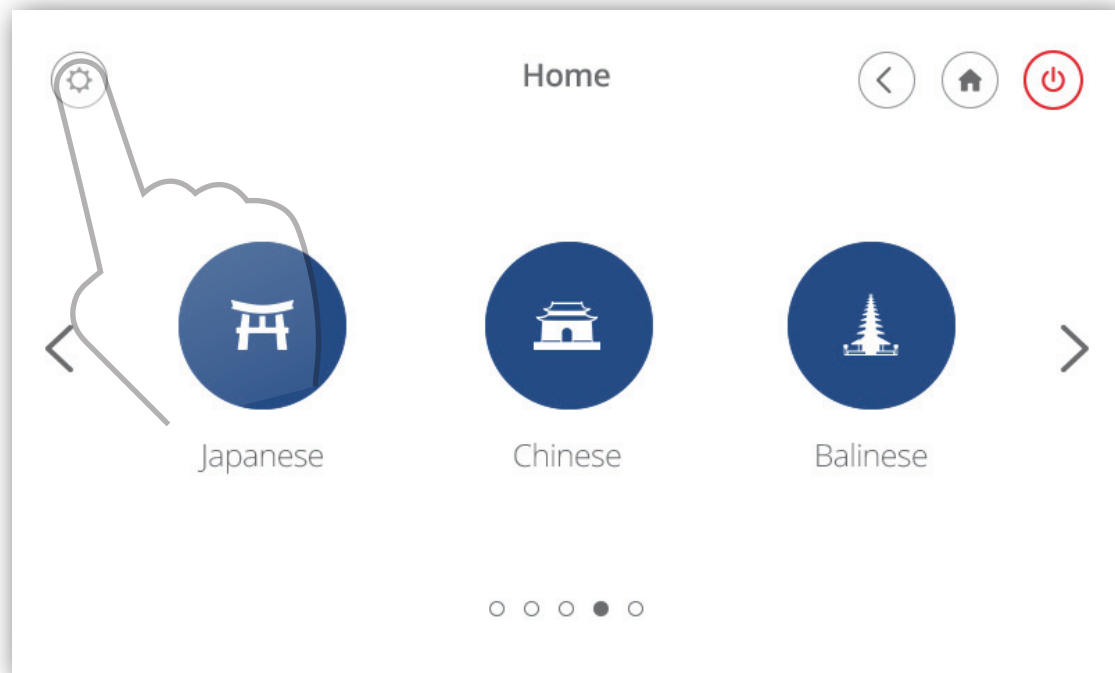

Choose the "Settings" button to take you to the settings page

Settings Interface

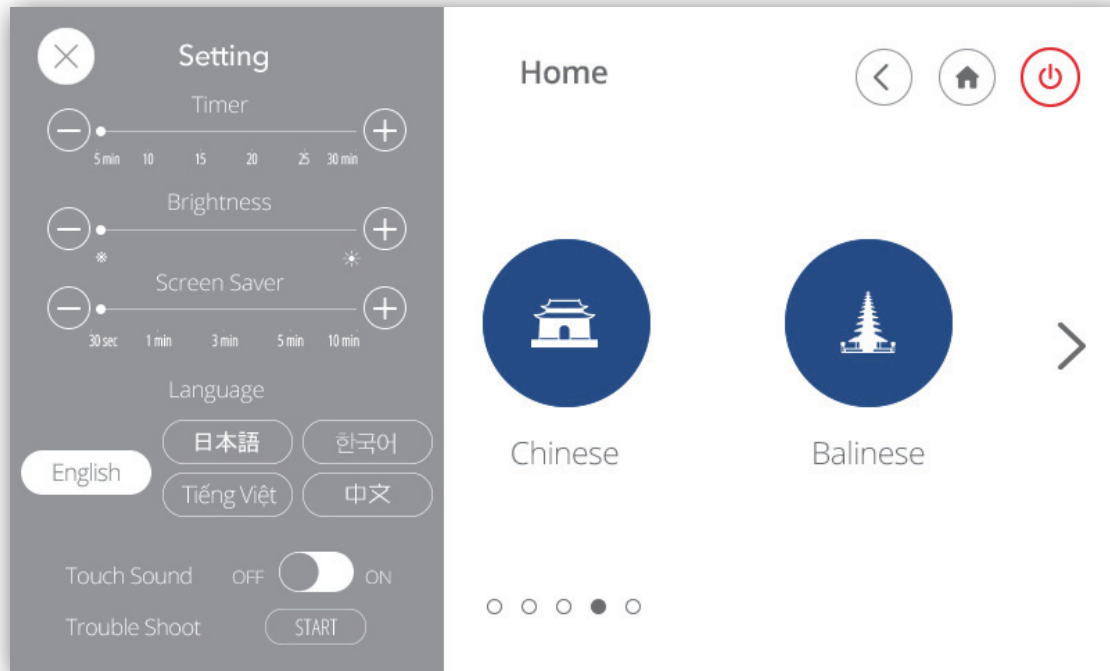

Trouble Shooting

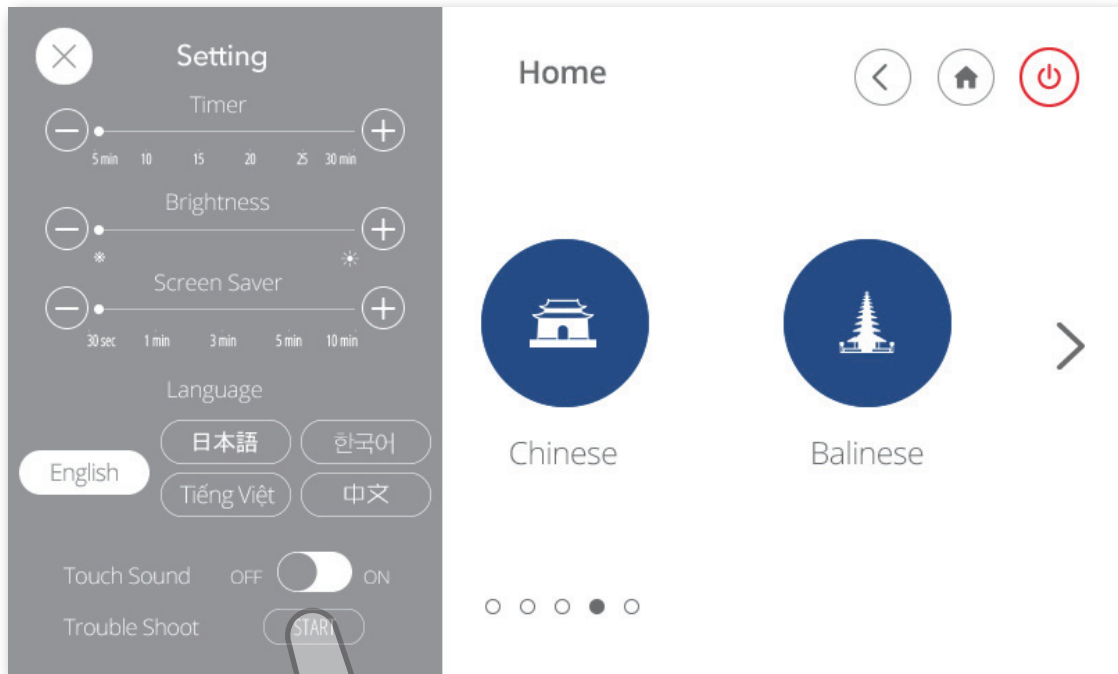

If your chair has any trouble, press the Trouble Shoot "Start" button for the chair to automatically detect problem areas and contact our customer service team

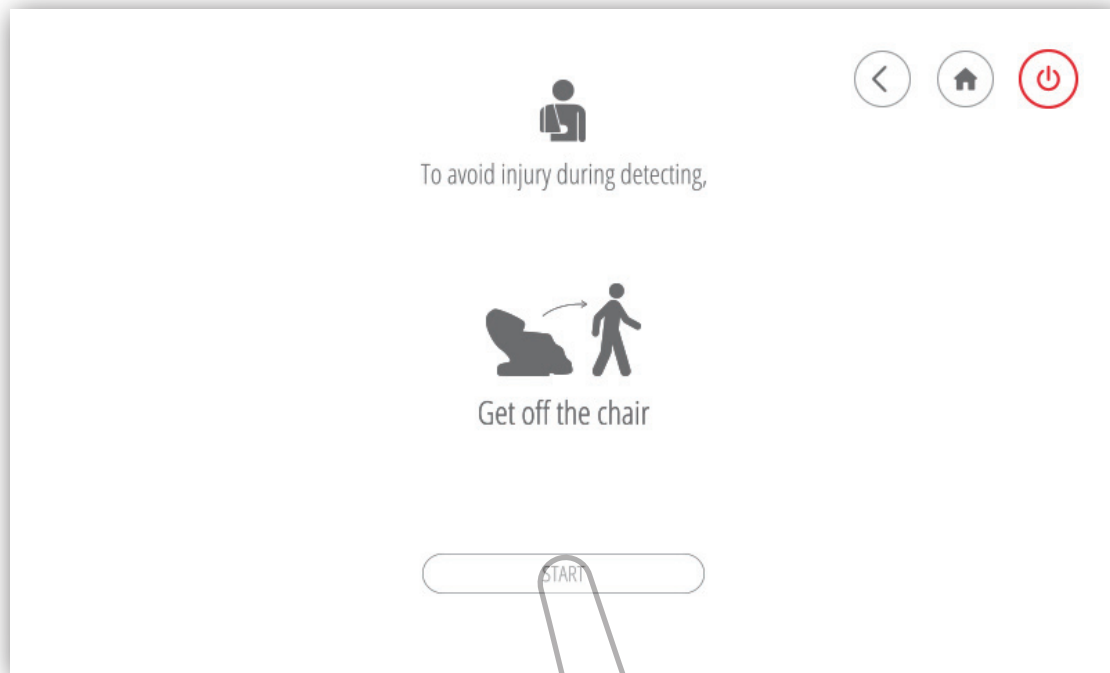

Choose "Start" button and make sure the chair is not occupied during chair detection

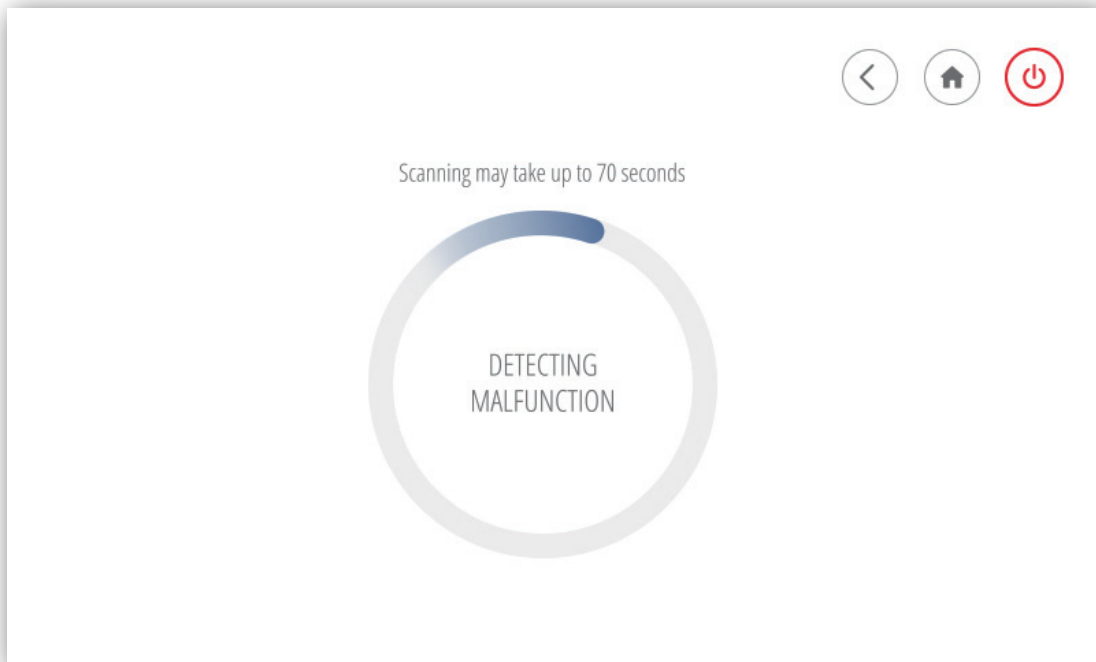

Your chair is detecting possible malfunctions, please wait for the detection result

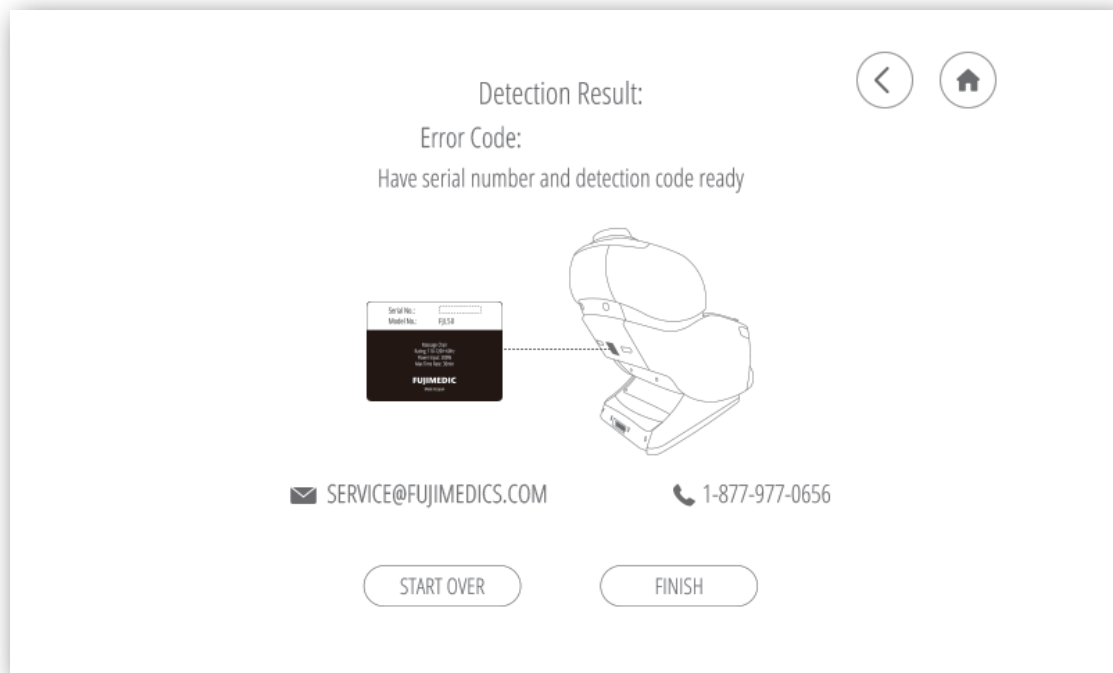

You can use your detection code when contacting the customer team about your chair's problems

Stretch



This massage will stretch your legs and back with a combination of gentle tapping, rolling, and air compression.

FOCUS AREA

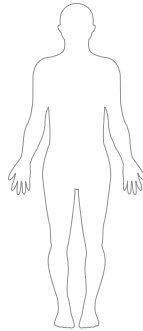

INTENSITY



FOCUS TECHNIQUE



TAP



KNEAD

Demo



This massage will quickly demonstrate all of the massage features in 5 minutes.

FOCUS AREA

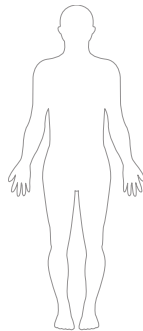

INTENSITY



FOCUS TECHNIQUE



TAP



ULTRA KNEAD

Spine Care



This massage will focus on your lower back with a deep massage that includes air compression.

FOCUS AREA

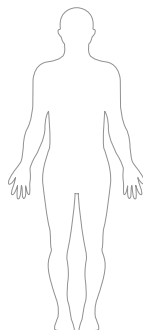

INTENSITY



FOCUS TECHNIQUE



SHIATSU



KNEAD

Gentle



This massage will slowly move up and down your back with gentle tapping, finishing with a relaxing shoulder massage.

FOCUS AREA

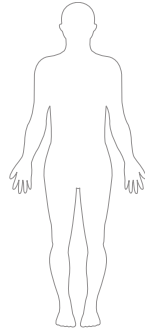

INTENSITY



FOCUS TECHNIQUE



TAP



KNEAD

Joint Care



This massage will focus on your feet and legs using fast, intense pressure as well as soothing your back with kneading rollers.

FOCUS AREA

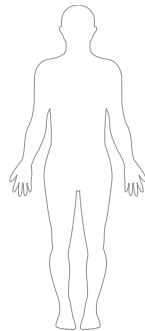

INTENSITY



FOCUS TECHNIQUE



TAP



ULTRA KNEAD

Relax



A program designed to provide a mild massage that is great for deep relaxation, best used before going to sleep.

FOCUS AREA

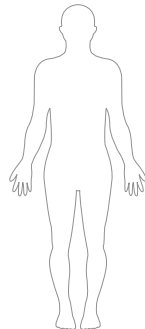

INTENSITY



FOCUS TECHNIQUE



SHIATSU



KNEAD

Swedish



This massage will focus on your neck down to glutes in the beginning then finish with a soothing rocking motion.

FOCUS AREA

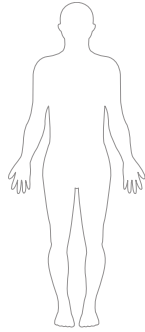

INTENSITY



FOCUS TECHNIQUE



Vigorous



This massage will combine vigorous tapping on your lower back and an air massage focused on your thighs and legs.

FOCUS AREA

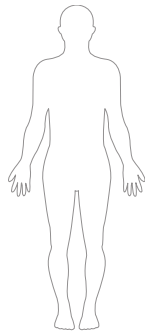

INTENSITY



FOCUS TECHNIQUE



Thai



A program designed to relax tense muscles using Thai styled techniques that helps with improvement of the immunity systems, pain relief, and blood circulation.

FOCUS AREA

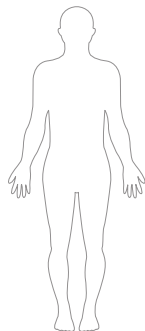

INTENSITY



FOCUS TECHNIQUE



Japanese



This massage will focus on your mid back and upper shoulders with a deep tissue massage using the shiatsu technique that will create an acupressure effect.

FOCUS AREA

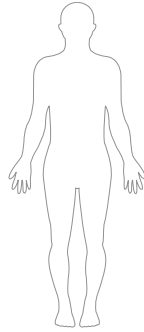

INTENSITY



FOCUS TECHNIQUE



SHIATSU KNEAD

Chinese



This massage will focus on your entire back while also massaging your legs and feet.

FOCUS AREA

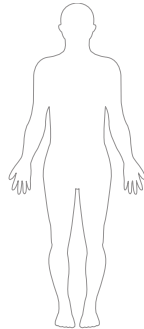

INTENSITY



FOCUS TECHNIQUE



TAP ULTRA KNEAD

Balinese



This massage will focus on your back and spine using fast, ultra kneading and tapping techniques.

FOCUS AREA

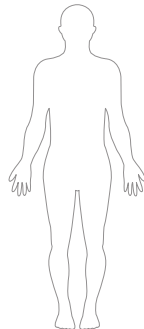

INTENSITY



FOCUS TECHNIQUE





SHIATSU KNEAD

IMPORTANT SAFETY INSTRUCTIONS

(MUST BE FOLLOWED)



The safety instructions must be strictly followed in use to avoid personal injuries and property damage as are as follows:



- All the safety instructions are described in compliance with degrees of the injuries or damage as a result of wrong use.

 Warning	Actions tending to cause serious injuries or death
 Caution	Actions tending to cause minor injuries or property damage

- Pay attention to the symbols before safety instructions (an example is given below).

 Actions that must be absolutely forbidden	 Actions that must be followed
---	---

 Warning	
 Must be followed	<ul style="list-style-type: none"> • Before using the product, persons who are being treated or have any of the following symptoms should consult a physician. <ol style="list-style-type: none"> (1) Persons with a pacemaker or other in-vivo electronic medical device tending to suffer electronic jamming. (2) Patients with malignant tumors. (3) Patients with heart disease. (4) Persons proved to be unable to identify temperatures. (5) Pregnant persons or women who have just had childbirth. (6) Persons with perceptual disturbance because of diabetes or another serious peripheral circulation disturbance. (7) Osteoporosis patients, spinal fracture patients or persons with acute painful diseases such as sprains or muscle strains. (8) Persons with injuries in the massaged parts. (9) Persons with a body temperature above 38 C (with a fever)(For example, persons with intense acute inflammation symptoms such as listlessness, cold shivers and blood pressure change or persons in poor health). (10) Persons who are unwell or must have a rest. (11) Persons with an abnormal or bent vertebra. (12) Persons with protrusion of intervertebral disc. (13) Persons who feel very uncomfortable (except for the circumstance above). <p>Otherwise accidents or physical discomfort may happen.</p> • If you feel physically abnormal while using or experience no effect after use, stop the product immediately and consult a physician about it. <p>Otherwise accidents or physical discomfort may happen.</p>

 Warning	
 Must be followed	<ul style="list-style-type: none"> • Before using the massage chair or moving the backrest or the footrest, make sure there is no person or pet close to the chair (in front, behind, below or on the side). • Before using the massage chair, make sure there is no foreign matter between the backrest and the back cover. <p>Otherwise accidents or physical discomfort may happen.</p> • Before using the massage chair, lift the backrest pad and check whether the fabric of the traveling sections of the massage rollers or other positions are damaged. (Even if the fabric is slightly damaged, stop the product immediately, pull out the power plug, and call customer service.) <p>If you use the product when the fabric is damaged, you may get injured or get an electric shock.</p> • Do not massage for more than 30 minutes each time. • Do not massage a single part for more than 5 minutes. <p>If any of these safety instructions are not followed, you may suffer an adverse effect and become injured.</p> • After use each time, turn the power switch to OFF position and disconnect the power plug. <p>Otherwise accidents or injuries may happen.</p> • Follow the regulations about use of the socket and the wiring devices. • Use a 110-120V, 60HZ power supply. Don't use the product in a foreign country or connect it with a transformer without permission. <p>Otherwise electric shocks, product faults or fires because of overheat may happen.</p> • Insert the power plug thoroughly into the socket. <p>Otherwise electric shocks or fires caused by overheat may happen.</p> • Remove dirt/dust from the power plug at regular intervals. <p>Otherwise fires caused by poor insulation due to factors such as moisture may happen. (Wipe the power plug with dry cloth).</p> • In the case of any abnormality or fault, stop the product immediately and pull out the power plug to avoid smoke, fires and electric shocks. <p>Abnormality and fault examples:</p> <ol style="list-style-type: none"> (1) The product fails to work after the power switch is turned to the ON position. (2) After the power line is moved, the product is discontinuously powered on. (3) During use, the product gives off a burning smell or an abnormal sound. (4) The product is deformed or abnormally heating. <p>In any of these abnormalities and faults, have the product inspected and repaired by an authorized service center immediately.</p> • If there is any foreign matter between backrest and main PCB box cover, stop the product, disconnect the power supply and take out the foreign matter by opening the protective fabric covering at the lower part of backrest. <p>Otherwise product faults or personal injuries may happen.</p>

Warning



- **Do not put the backrest pad between the backrest and the Main PCB box cover.**
Otherwise product faults may happen.
- **The following persons should not use the product.**
Persons for whom massage is forbidden by doctors, such as persons with thrombosis, serious aneurysm, acute venous aneurysm, various skin inflammations (such as subcutaneous tissue inflammation) or various skin infections.
Otherwise disease may get worse.
- **The following persons should not massage their waists:**
 - (1) Persons with acute lumbago, protrusion of intervertebral disc, or displacement of a lumbar vertebra.
 - (2) Persons with deformation or other discomfort of the hip joint.Otherwise disease may get worse.
- **Do not put hands, arms or feet into the backrest's fabric of travelling sections of the massage wheels.**
- **Children should not use the product.** Keep them from playing on the product or climbing onto the footrest, the seat, the backrest, or the armrests.
- **Do not climb onto the backrest or the armrests.**
- **Do not lean or sit on the backrest.**
- **Persons unable to express themselves clearly or unable to operate the product should not use the product.**
- **When massaging the neck, pay attention to moving directions of the massage wheels and do not massage with a too much force or massage the front part of the neck.**
Otherwise accidents or personal injuries may happen.
- **Do not damage the power cord or the power plug.**
(Do not damage, machine, forcedly bent, twist or prolong the power cord or the power plug, or place the power cord or the plug close to a heater, or tie or bind any heavy objects on the power cord or the power plug).
A damaged power cord or power plug may result in electric shocks, short circuit faults or fires.
Please consult the shop from which you bought the product or a designated authorized service center about the maintenance method of the power line or the power plug.
- **Do not damage the foot warm (heater) section.**
- **Do not insert pins or needles into the product.**
- **Do not cut the product with a cutter.**
If the internal heater is damaged, fires or electric shocks may happen.
- **Do not insert or pull out the power plug with wet hands.**
Otherwise electric shocks may happen.
- **Do not refit, disassemble or repair the product without permission.**
Otherwise fires, abnormal movements or personal injuries may happen.



Caution

- **The following persons (even if they are physically healthy at present) should consult a physician before using the product:**
 - (1) Persons with muscular atrophy due to aging or thin persons.
 - (2) Persons feeling lumbago because of bone or viscus problem.
 - (3) Persons tending to suffer sprains or bruising.
 - (4) Persons with carsickness or seasickness or strong response when taking other transport means.
 - (5) Persons who once received a heat operation or another visceral operation.Otherwise health may get worse.
- **Before sitting on the product, make sure there is no foreign matter between any two parts of it. (Make sure there is no foreign matter on the backrest pad, the backrest, the seat pad, the footrest or inside the surface of backrest pad.)**
Otherwise accidents, injuries, or product faults caused by clamping of hands, feet, or other articles by the product may happen.
- **Do not use the product when wearing any hard decorative article on hand (such as a watch). If there is any hard article (such as a mobile phone or key) in your pants pocket, take it out before getting into the chair.**
- **Before hand or arm massage, remove watch, rings, etc.**
Otherwise injuries may happen.
- **Before sitting on the seat, make sure the massage rollers are in the home positions.**
- **If you want to leave the seat during the massage, stop the product first.**
Otherwise accidents or injuries may happen.
- **When pulling out the power plug, do not pull the power line but hold the power plug.**
Otherwise an electric shock or a short circuit fault may happen.
- **When moving the product by pulleys, put articles such as mats on the floor.**
Otherwise marks may be left on the floor.
- **Keep children from the retaining screws on the remote controller holder.**
Otherwise children may cause accidents or suffer injuries by eating it or playing with it.
- **Before moving the product by pulleys, remove the obstructions close to it. Lift the footrest to a position a little lower than the waist and move the product slowly.**
Otherwise accidents or injuries may happen because of turnover of the product.
- **In use, place the product horizontally.**
Otherwise accidents due to turnover the product may happen.
- **If any symptom such as skin inflammation, itching, or swelling occurs, stop the product immediately and consult a physician.**
Otherwise accidents or injuries may happen.



 Must be followed	<ul style="list-style-type: none"> • If the product is used again for massage after a period of out-of-service, read the user manual again and make sure the product can run normally first. Otherwise accidents or injuries may happen.
---	---

 Caution	
 Forbidden	<ul style="list-style-type: none"> • Do not use the product and other devices at the same time. Otherwise accidents or physical discomfort may happen. • Keep hands, abdomen or skin from the massage rollers and do not put hands or feet between the massage rollers. • Do not put the knees between the lower footrest and upper footrest. • Do not fall asleep while using the product. Do not use the product after drinking. • If the air in the air bag on the seat is not completely discharged, do not stand or jump on the seat or put things on it. Otherwise accidents or injuries may happen. • Do not put hands or feet between the base and the footrest. • Do not put hands, arms, or head into the seam of the footrest. • For safety, admit the footrest after massage. • Do not put hands, feet or head between the backrest and the main PCB box cover. • Do not put pets on the product (such as its main PCB box cover, backrest and armrest). • Do not pull out the power plug or turn OFF the power switch suddenly during massage. Otherwise injuries may happen.
	<ul style="list-style-type: none"> • Do not stand or sit on the main PCB box cover. Otherwise personal injuries due to the product toppling may occur. • Do not stand or sit on the armrests. Otherwise personal injuries due to the product toppling may occur. • Do not drag or push the product after it is installed. Otherwise the floor maybe damaged. • Do not move the product while there is a person on it. Otherwise, accidents, or injuries may happen due to a toppling of the product. • Do not use the product with heating devices such as electric blankets. Otherwise fires may happen. • Do not put the remote controller on the product. Otherwise the product may be damaged. • Wet-hand contact forbidden • Do not use the product in a bathroom or another wet place. Otherwise electric shocks or product faults may happen.

 Caution	
 Forbidden	<ul style="list-style-type: none"> • Product wetting forbidden. • Do not sprinkle substances such as water on the product or its remote controller. Otherwise electric shocks, short circuit or product faults may happen. • Pull out the power plug. • Before cleaning or maintaining the product, pull out the power plug first. Otherwise electric shocks or injuries may happen. • In the case of a power failure, pull out the power plug at once. Otherwise accidents or injuries may happen when power is restored. • When the product is not used, pull out the power plug. Otherwise electric leakage fires may happen because of insulation aging caused by dust and moisture.

GROUNDING INSTRUCTIONS

The product must be grounded to reduce the electric shock hazard because of functional faults of the product. The product has a power cord with a grounding conductor and a grounding plug. The grounding plug must be inserted into an appropriate socket that has been correctly installed and grounded in full compliance with the local code and decree.

 Caution	
<p>If the grounding conductor is not correctly connected, electric shocks may happen. If you are not sure about correctness of the grounding, have it inspected by a professional electrician. Even if the grounding plug provided with the product does not match with the socket you have, do not refit it by yourself but ask a professional electrician to install a appropriate socket.</p> <p>The product has a grounding plug. Make sure the product is connected with a socket matching with shape of the grounding plug.</p> <p>Do not connect the product to a multi-plug.</p>	

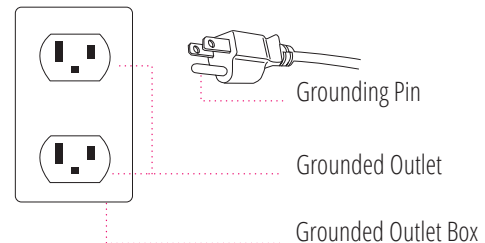

PRODUCT CLEANING

Wipe the synthetic leather with a soft dry cloth.

- Don't clean the product with chemicals such as thinner, gasoline and alcohol.
- When using a leather maintenance product (cleaning cloth) sold on the market, follow its directions for use.
- If the synthetic leather is very dirty, wipe it with the method below.
 - ① Put a piece of soft cloth into water or 3% to 5% neutral detergent contained hot water and wring it out.
 - ② Wipe surface of the synthetic leather with the soft cloth.
 - ③ Wipe the detergent with a piece of cloth once soaked in clean water and wrung out.
 - ④ Wipe with a piece of wrung soft cloth.
 - ⑤ Allow the synthetic leather to air dry.
- If it is difficult to remove the stains on the synthetic leather, soak a piece of melamine foam bought from the market into a neutral detergent and use it wipe the product.
- Do not dry the surface with a hair drier.
- Surface of the synthetic leather may be dyed by fabric colors; therefore, be careful when wiping the product with denim or colored cloth.
- Keep these positions from long-time contact with plastics to avoid fading.
- Synthetic leather may discolor, so the position in contact with the hair dye used should be covered by a towel.

CONSUMER WARRANTY

The FJL50 massage chair has a three year in-home service warranty. The warranties are only valid in the 48 contiguous states. We do not provide a warranty for chairs sold to Alaska or Hawaii.

Consumers may contact the Fujimed customer service department at 1-877-977-0656 between 9:00 am and 5:00 pm PST, Monday through Friday or email us at service@fujimedics.com for warranty or service issues.

The warranty period begins from the day of purchase; no allowance or extension is offered for delivery and/or installation.

The warranty only applies to FJL50 massage chair, any accessories or enhancements are not included.

The Fujimed service department will make an appointment with the consumer before they arrange in-home service which is performed by authorized technician.

In certain situations, the warranty does not apply :

A: Customer cannot provide receipt and warranty card.

B: Damage caused by improper installation, abuse, or improper maintenance.

C: Damage caused by disaster (ex. earthquake, fire, flood, etc.), abnormal power supply, breakages (ex. pets chewing, drink spilling, etc.).

D: Massage chair repaired by unauthorized technician or if unauthorized modifications occur to the massage chair.

If the synthetic leather, fabric, sponge, or fillers become naturally worn, they are not considered as defect under this warranty. Read the safety instructions before using this massage chair. Under no circumstance shall Fujimed or its representatives be liable for indirect, consequential, or incidental damages (including damages for lost profits, business interruption, bodily injury, and so on).

The warranties are not applicable if the massage chair is being utilized for business use.

861 S. Oak Park Road,
Covina, CA 91724

TEL: 1-877-977-0656

FAX: 1-800-521-4712

SERVICE@FUJIMEDICS.COM