

**User manual**  
**Manuel de l'utilisateur****Massage Chair :**  
**Fauteuil de Massage : JP-3000**

Category: machinery and appliances  
general designation: household electric massage chair

Catégorie: machines et appareils.  
Désignation générale: fauteuil de massage électrique à usage personnel

Refer to 10-15 pages how to  
assemble each parts on the  
massage chair.

Référez-vous aux pages 82~87 pour  
assembler les différentes parties  
du fauteuil de massage.

**Before use**

- IMPORTANT SAFETY INSTRUCTIONS ..... 3
- Names and Functions ..... 8
- Setup and assembling ..... 10
- Before starting massage every time ..... 16

**How to use**

- About the massage chair 2 Modes ..... 18
- Adjust the reclining and footrest angle ..... 20
- Massage by Auto Mode Course ..... 22
- About the end of Massage ..... 30
- Rubbing massage ..... 32
- Air massage ..... 37
- Parts intensive massage ..... 40
- C ombine the rubbing and air massage ..... 42
- Foot roller massage ..... 43
- When changing the Massage in the middle ..... 45
- QUICK MODE/LANGUAGE/ AUTO-RECLINE settings ..... 46
- About voice guidance ..... 48
- Heater ON/OFF ..... 49
- To set the child lock ..... 50
- Usage of BLUETOOTH speaker ..... 51
- About User Customized Mode ..... 56

**Maintenance/Q&A**

- Maintenance and storage ..... 64
- Q&A ..... 66

**Customer service**

- Trouble shooting ..... 68
- Specifications ..... 72

**Avant l'utilisation**

- CONSIGNES DE SÉCURITÉ IMPORTANTES ..... 74
- Noms et Fonctions ..... 80
- Mise en place et montage ..... 82
- Avant de commencer chaque massage ..... 88

**Utilisation**

- Introduction aux 2 Modes du fauteuil de massage ..... 90
- Réglez l'angle de l'inclinaison et du repose-pieds ..... 92
- Massage en Session Mode Auto ..... 94
- Fin du Massage ..... 102
- Massage par pétrissage ..... 104
- Massage par air ..... 109
- Massages partiels intensifs ..... 112
- Combiner les massages par pétrissage et par air ..... 114
- Massage des pieds par rouleaux ..... 115
- Changement du Massage en cours ..... 116
- Paramétrages MODE RAPIDE/LANGUE/INCLINAISON AUTO ..... 118
- Guidage vocal ..... 120
- Chauffage MARCHE/ARRÊT ..... 121
- Configurer la sécurité enfants ..... 122
- Utiliser les haut-parleurs BLUETOOTH ..... 123
- Mode Personnalisé de l'Utilisateur ..... 128

**Entretien/Q&A**

- Entretien et stockage ..... 136
- Q&A ..... 138

**Service clientèle**

- Résolution de problèmes ..... 140
- Spécifications ..... 144

**Purpose of use, effect-efficacy**

Substitution of massage for home-use

- Thank you very much for purchasing Fujiiryoki massage chair.
- Carefully read this operation manual before use and only use as directed.
- Please read the safety precautions on pages 3-7 before use.
- Keep this operation manual where it will be readily available for future referral.
- Please recycle the outer packaging material where possible.



**Objectif de l'utilisation, effet-efficacité**

Substitution au massage pour un usage privé



- Nous vous remercions d'avoir acheté le fauteuil de massage Fujiiryoki.
- Veuillez lire attentivement ce manuel d'utilisation avant toute utilisation et respectez impérativement les consignes.
- Veuillez lire les précautions de sécurité figurant dans les pages 74 à 79 avant toute utilisation.
- Conservez ce manuel d'utilisation à portée de main.
- Veuillez recycler le matériel d'emballage extérieur dans la mesure du possible.

# IMPORTANT SAFETY INSTRUCTIONS

- Read these "Important Safety Instructions" before use and use this product properly
- These important safety instructions are prescribed to ensure correct usage of the product, and to prevent injury and damage to the user and other persons.
- Followings are the display and contents.
- Please keep to the regulations as these are important instructions for your safety.

 <b>DANGER</b>	Improper usage may result in serious injury or death.
 <b>WARNING</b>	Improper usage may result in injury or damage to property.*

\*Property refers to houses, household belongings, domestic animals and pets.

	<p>⊘ Prohibited actions The prohibited action is illustrated inside the illustration (for example, the illustration on the left refers to "Prohibiting disassembling")</p>
	<p>● Directives, actions which are compulsory The prohibited action is illustrated inside the illustration (for example, the illustration on the left refers to "unplugging the power plug")</p>

- Always keep this operation manual where it will be readily available for referral.
- Attention: When disposing of this product and/or its accessories, do so in accordance with local laws and regulations. For details, please refer to your local authority.

DANGER

	<p>The Because this equipment has a built-in heater and the surface becomes hot, person who are not sensitive to heat should pay attention to use. Pay full attention when it falls under the following.</p> <ul style="list-style-type: none"> <li>•elderly, ailing person, those who cannot operate by themselves</li> <li>•persons who took medicine that cause drowsiness(sleeping pills, cold medicine)</li> <li>•persons with heavy drinking, heavy tiredness •persons with hematogenous disorder (diabetes, etc.) •persons who receive a note from the doctor</li> <li>•people with weak temperature sense.</li> </ul> <p>There is a risk of low temperature burns, dehydration.</p>
	<p>The following persons must consult a medical physician before using this product.</p> <ul style="list-style-type: none"> <li>•Persons using a medical electronic device embedded in the body such as a pacemaker susceptible to the electromagnetic disturbances.</li> <li>•persons with malignant tumors. •persons with heart diseases. •persons who are pregnancy or those immediately after childbirth. •persons who suffer from paresthesia related to peripheral circulatory disturbance due to diabetes etc.</li> <li>•persons with wounds on their skin. •persons in need of repose. •persons with Temperature sensory loss. •persons with body temperatures exceeding 38°C. (when strong acute inflammation symptoms, malaise, hills, blood pressure fluctuations are observed, when debilitated) •persons with herniated discs. •a person with tendovaginitis.</li> <li>•persons who suffer from osteoporosis, spinal column fractures, or acute pains.</li> <li>•persons with abnormalities in the spine, or those whose spines are bent.</li> <li>•persons who feel an abnormality on the body not prescribed above, persons in treatment by a doctor.</li> </ul>



# DANGER

If the chair stops moving or any abnormalities occur, unplug the power plug and contact the point of purchase for an inspection/repairs.  
Electrification, short circuits and fire may occur.

Take care of the movements of the knead balls when massaging around neck. Avoid excessive massaging or massaging the front of the neck.  
Accidents or injuries may occur.

When reclining or lowering the footrest, always check underneath and surroundings the footrest for people, pets, and other items.  
Accidents or injuries may occur.

When reclining or lowering the footrest, be careful not to get hands, fingers, feet, head caught underneath the footrest or backrest.  
●underneath the chair itself ●backrest, seat, clearance of armrest ●clearance of footrest, seat, armrest ●underneath the footrest, the back of footrest ●clearance between arm and armrest ●behind the backrest  
Accidents or injuries may occur.

Before use, check underneath the back pad to make sure that there are no rips or tears in the cover cloth of the seat back. (should there be any rips or tears, no matter how small, immediately discontinue use, disconnect the power cord, and ask for repairs to be conducted).  
Continued use with rips or tears in the cloth of the seat back may cause electric shocks or injuries.

Always unplug this appliance from the electrical outlet immediately after using and before cleaning.

Not long term use of heater and same spot on the body  
If heat is used on the same spot for a long time, low temperature burns may occur even if the temperature is comparatively low in 40-60°C.

About low temperature burn —————  
●low temperature burn effect the deep part of the skin and show red specks or blisters.  
●In case red specks or blisters are found, consult a medical physician immediately.

The following persons are strongly recommended not to use this product. Certain prohibited from receiving a massage by a medical physician.  
(for example those suffering from thrombosis, severe aneurysm, acute varicose veins, various kinds of dermatitis and skin infections (including inflammations of subcutaneous tissue), etc.)

Do not remove, rip or cut the cover of the chair(backrest, footrest, armrest) on purpose.  
Never use the chair with the cover removed or torn as clothes and hair may get caught in the knead balls.

Do not use the chair other than on the designated voltage. Fire or electrification may occur.

Do not use the chair when the power cord or its plug is damaged, or when the receptacle is loose. Contact your point of purchase for repairs if the power cord or power plug are damaged in anyway. Continued usage may result in electric shocks, shortage, or even fire.

Surely plug the power plug to the root and keep away from the dust. Doing so may cause damage, fire and electrification.

Do not allow unattended children or persons unable to declare their own intentions to use this chair. Do not allow infants near the chair. Electrification or injuries may occur.

Do not allow children to play or get on the chair. Accidents or injuries may occur.

Do not connect or disconnect the power plug with wet hands. Electrification may occur.



# IMPORTANT SAFETY INSTRUCTIONS



## DANGER

	Never use pins or other metallic fasteners with this appliance.
	Carefully examine the covering before each use. Discard the appliance if the covering shows any sign of deterioration, such as checking, blistering, or cracking.
	Do not use or store in the bathrooms or places of high humidity or moisture. Electrification, fire, accidents, and moulding may occur.
	Never remodel or decompose/repair by yourself. Fire or injury due to abnormal action may occur.



## WARNING

	Usage of this product should be limited to 30 minutes for each use. Continual use on the same part of the body should be limited to 5 minutes. Prolonged use may damage muscles and nerves.(Only use for 30 minutes per day.)
	The following persons should consult a medical physician before using this product. <ul style="list-style-type: none"> <li>•persons whose muscles have become weak due to increasing age, and those who are of slim build.</li> <li>•persons suffering from lower back pain caused by bones or internal organs.</li> <li>•persons easily bruised, susceptible to sprains.</li> <li>•persons who suffer from intense motion sickness.</li> <li>•persons who have undergone internal organ or heart operations.</li> </ul>
	If any rashes, reddening of the skin, itches or similar symptoms appear after using this product, immediately stop using and consult a physician. Accident and ill health may occur.
	An appliance should never be left unattended when plugged in. Unplug from outlet when not in use, and before putting on or taking off parts. To disconnect, turn all controls to the off position, then remove plug from outlet. This may result in accidents due to children's mischief.
	Use the chair on a level surface. Do not use outdoors. Damage or accidents may occur.
	Make sure operation buttons and timers are operating normally before use. Accidents or injury may occur.
	Read the operation manual once again and confirm the product is operating normally before using the chair after a prolonged period of non-use. Accidents or injury may occur.
	Confirm no items get caught in the chair (backrest, footrest, armrest) before use. Never drop or insert any object into any opening. Accidents or injury may occur.
	Do not place feet or hands on the footrest when the footrest is retracting. Accidents or injury may occur.
	When any physical abnormalities appear or are felt during operation, stop using the product immediately and consult a physician.
	Sit down slowly after confirming the knead balls are located at the storage position. Accidents or injury may occur.
	Use weak stimulation massage when you start to use. Injury may occur.



# WARNING



Make sure the ground terminal is installed. Damages or electrification may occur when ground terminal is not installed.



Turn the power switch OFF and unplug the power cord immediately in times of power shortages. When power is restored accidents may occur.

Unplug the power plug by holding the actual power plug and not the cord. This may cause electrification, short circuits, or fire.

Unplug the power plug when not using the chair. This may cause a fire due to insulation degradation by dust or humidity.

When maintaining the chair always unplug the power cord. This may cause electrification or injury.



Never operate the appliance with the air openings blocked. Keep the air openings free of lint, hair, and the like.

Never drop or insert any object into any opening.

To disconnect, turn all controls to the off position, than remove plug from outlet.

The appliance is intended for household use.

Temperatures sufficiently high to cause burns may occur egrardless of the control setting. Do not use on an infant or invalid or on a sleeping or unconscious person. Do not use on insensitiv skin or on a person with poor blood circulation. Check the skin in contact with the heated area of the appliance frequently to reduce the risk of blistering.

Do Not Crush - Avoid sharp folds.

Do not damage the power cord or power plug.

- Do not hurt ●Do not damage ●Do not process ●unreasonably bend or pull.
- Do not twist ●Do not tie ●Do not place heavy items on the power cord. ●Do not get the power cord caught, especially when moving the chair.

Never operate this appliance if it has a damaged cord or plug, if it is not working properly, if it has been dropped or damaged, or dropped into water. Return the appliance to a service center for examination and repair.

Continued usage may result in electric shocks, shortage, or even fire.

Do not use immediately after eating or consuming alcohol. Nausea, illness, accidents or injury may occur.

Do not close to stoves or other sources of fire, nor smoke whilst using the chair. Do not use on heated carpets or other geating equipment. Do not operate under blanket or pillow. Excessive heating can occur and cause fire, Electric shock, or injury to persons. Keep the cord away from heated surfaces. This may cause fire.

Do not stand on the seat, or get on the seat back, footrest, arm or shoulder portion of the chair. The user or chair may rollover and injury or accidents may result.

Do not stand or sit down on upper part of the backrest, the front of the seat or on the footrest when the chair is reclining. The user or chair may rollover and injury or accidents may result.

Do not try to sit or get up from the chair when the chair is reclining or the footrest is elevated. The user or chair may rollover and injury or accidents may result.

# IMPORTANT SAFETY INSTRUCTIONS



## WARNING



Do not use accessories other than those which accompany the chair. Doing so may cause product malfunction.

Do not use the hand/arm massage whilst wearing watches, rings, fake fingernail or bracelets. This may cause injury.

Do not use the chair whilst wearing earrings, necklaces, scarves, or other ornaments. This may cause injury.

Do not use the chair whilst wearing hard objects on the head, such as hair ornaments. This may cause injury.

Do not use the thigh or hip massage with hard objects in pockets. This may cause accidents or injury.

Do not use while naked. Direct massages on the naked body may damage the skin.

Do not use on the elbow, knee, head, abdomen areas. Do not get hands or feet caught in the knead balls. Injuries may occur.

Do not pull out the power cord, or turn off the power switch whilst using the chair. This may cause accidents or injury.

Do not sleep whilst using the chair. This may cause ill health or injury.

Do not move the chair while people or items are on the chair. Damage or injuries may occur.

Make sure no more than 1 person is on the chair at any one time. Doing so may result in damage to the chair or injury.

Do not wipe with benzine, paint thinner or alcohol, nor spray with any pharmaceutical sprays. This may cause fire or electrification.

Not to be used for purposes other than massage purposes. This may cause damage or accidents.

Do not use other therapeutic equipments whilst using this product. This may cause ill health or accidents.

Do not haul the chair itself or move with the casters on the floor where it easily gets scratches.

Do not overturn the chair or subject the chair to any strong shocks. Damage or injury may occur.

Do not hit toes to the foot rollers. Injury may occur.

Do not operate where aerosol (spray) products are being used or where oxygen is being administered.

Use this appliance only for its intended use as described in this manual. Do not use attachments not recommended by the manufacturer.

Do not carry this appliance by supply cord or use cord as a handle.

Never operate the appliance with the air openings blocked. Keep the air openings free of lint, hair, and the like.

Close supervision is necessary when this appliance is used by, on, or near children, invalids, or disabled persons.



## WARNING



Never operate this appliance if it has a damaged cord or plug, if it is not working properly, if it has been dropped or damaged, or dropped into water. Return the appliance to a service center for examination and repair.

Keep the cord away from heated surfaces.

Use heated surfaces carefully. May cause serious burns. Do not use over insensitive skin areas or in the presence of poor circulation. The unattended use of heat by children or incapacitated persons may be dangerous.

Keep children away from extended foot support, back support (or other similar parts).

Connect this appliance to a properly grounded outlet only. See Grounding Instructions.

This appliance is not intended for use by persons (including children) with reduced physical, sensory or mental capabilities, or lack of experience and knowledge, unless they have been given supervision or instruction concerning use of the appliance by a person responsible for their safety.

Children should be supervised to ensure that they do not play with the appliance.

Cleaning and user maintenance shall not be made by children without supervision

Please do not listen at high volume.  
Listening at a high volume for a long time may damage your hearing.

# Names and Functions

## Chair

### Front side

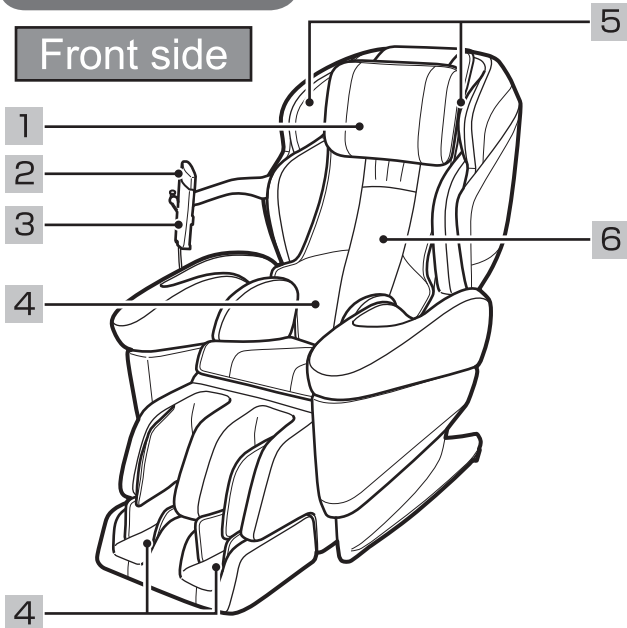

### Rear side

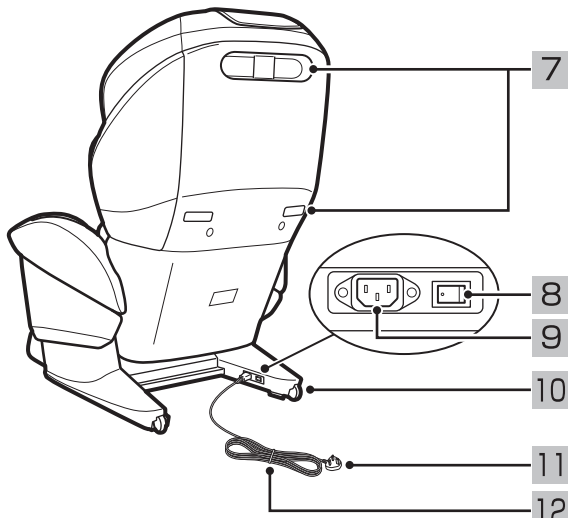

### Massage position

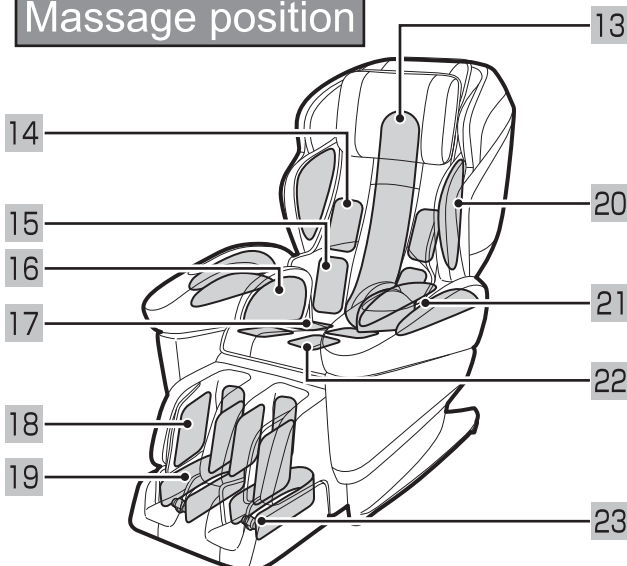

### Front side

- 1 Pillow  
Turn back the pillow pad during massage
- 2 Remote control
- 3 Remote control stand
- 4 Heat  
Built-in the back, sole of the feet
- 5 BLUETOOTH speaker  
Enjoy music through BLUETOOTH.
- 6 Back pad  
Slowly lean against the back pad

### Rear side

- 7 Handle
- 8 Power switch  
Turn the power switch OFF after use
- 9 Inlet (power cord plug-in port)
- 10 Caster
- 11 Power plug
- 12 Power cord

### Massage position

- 13 Backrest  
Massage whole the back area of the body

- 14 ~ 22 Air massage for each body part.

- |             |          |           |
|-------------|----------|-----------|
| 14 back     | 15 waist | 16 pelvis |
| 17 hip      | 18 calf  | 19 ankle  |
| 20 shoulder | 21 arm   | 22 thigh  |

- 23 Foot roller  
Roller massage for sole of the feet.



## Remote control

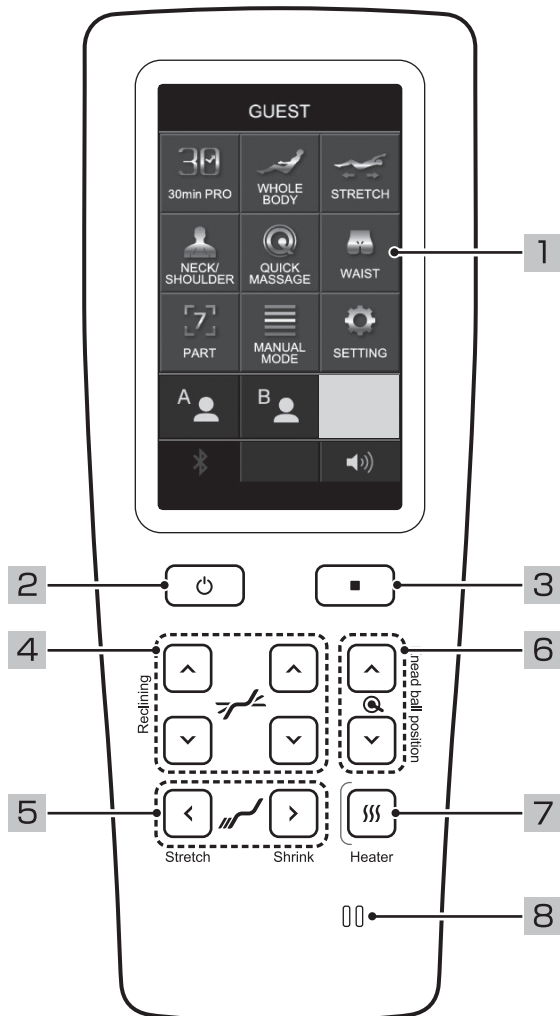





### Front side

- 1 LCD screen (Touch panel)
- 2 ON/OFF button  
on/off of the power supply
- 3 STOP button  
Stop all operations.(Press this button to stop massages immediately.)
- 4 Reclining angle adjustment button
- 5 Footrest slide button
- 6 Knead ball position adjustment button
- 7 Heat ON/OFF button
- 8 Voice guide speaker

## About operation method

LCD screen is a touch panel. The parts which can be operated through fingers are displayed in "gray" color and parts which cannot be operated are displayed in "Dark gray". (Except a part)

### [Description of some Buttons]

-  : Message gets stopped and returns to regular screen.
-  : Returns to the previous screen. The contents are not reflected when any option or setting is changed.
-  : Options or setting are decided and reflected.
-  : Adjust the volume of the voice guidance.

### [Display side]

The parts which can be operated by pressing are displayed in "gray" color

The diagram shows the 'MANUAL MODE' screen with settings for 'MECHA 12', 'ROLLER 2', and 'AIR STRENGTH'. Below are 'TAPPING' options and a 'SELECT PROGRAM' button. A bottom status bar shows '18 min'. Callouts explain the color coding: 'gray' for touchable parts and 'black' for non-touchable parts. A legend at the bottom right shows icons for home, back, and speaker, with a note that these are exceptions to the 'black' color rule.

# Setup and assembling

## Check the Main unit and accessories

**! WARNING**

Do not use accessories other than those which accompany the chair. Doing so may cause product malfunction.

User manual documents	
● User manual	● Assembling leaflets

- Whole

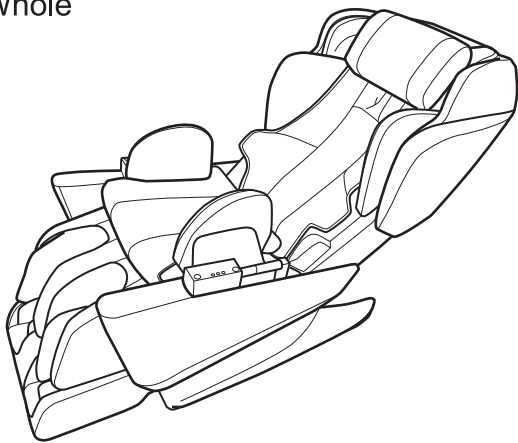

The massage chair comes with an attached pillow that can be detached at will.

- Arm unit (left)(right)

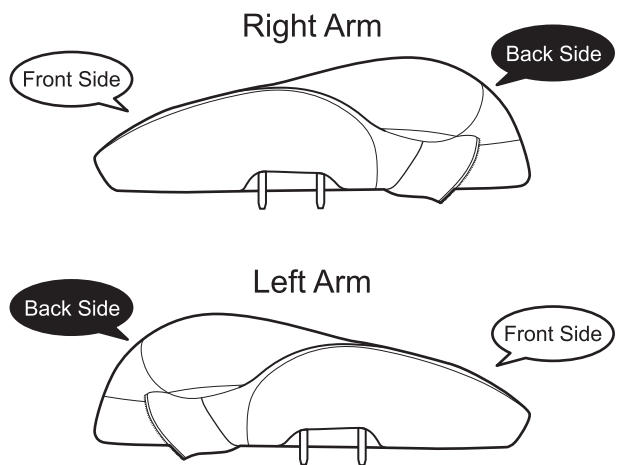

- Remote control stand

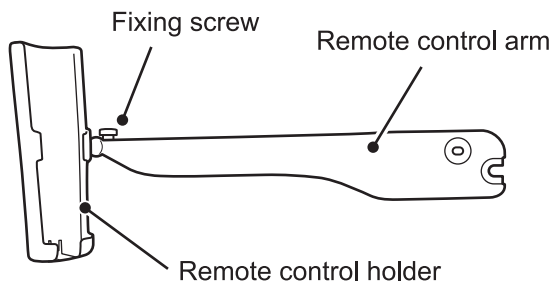

- Screw: 1



- Washer: 1



- Power cord

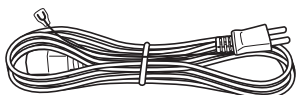

For a correct installation, make sure to check the front/back and left/right directions of the arm unit.

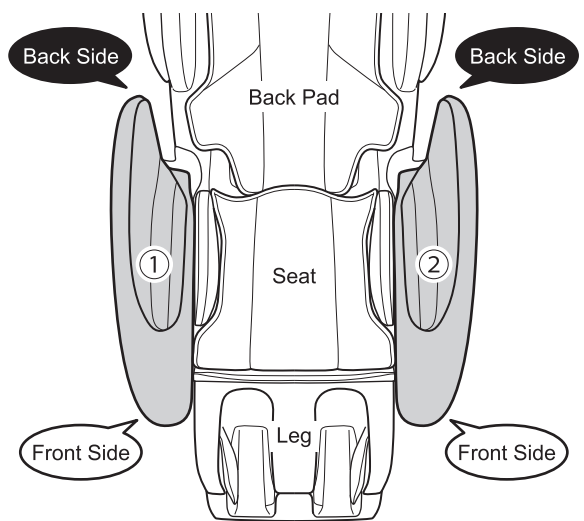

Massage chair view from above

## Deciding the setup place of whole unit

### DANGER

Do not use or store in the bathrooms or places of high humidity or moisture. Electrification, fire, accidents, and moulding may occur.

### WARNING

Use the chair on a level surface. Do not use outdoors. Damage or accidents may occur.

Do not close to stoves or other sources of fire, nor smoke whilst using the chair. Do not use on heated carpets or other heating equipment. Do not operate under blanket or pillow. Excessive heating can occur and cause fire, Electric shock, or injury to persons. Keep the cord away from heated surfaces. This may cause fire.

It should be installed in a flat surface where there is 50cm space from behind for reclining.

- If power supply is switched ON, then body automatically moves backwards and foot rest rises till it reaches the standby position. It is good to have the main unit surrounding with more than 30cm space from front and 50cm space from behind.

- During reclining, even the foot rest raises.
- Do not setup the whole unit in places where there is direct sunlight every day, or near heat appliances or near high temperature. Failure to do so may lead to color change or quality degrading in main unit.

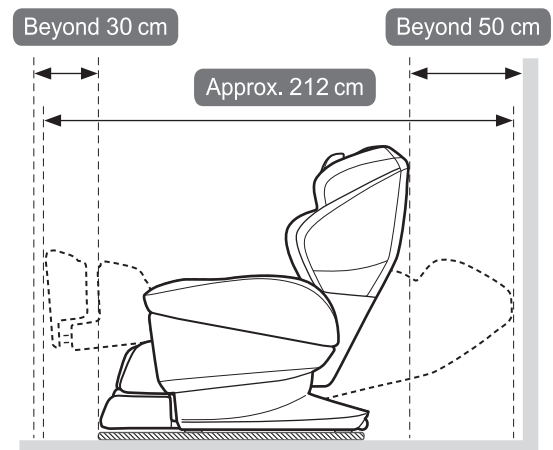

## Whole Setup

### WARNING

Do not move the chair while people or items are on the chair. Damage or injuries may occur.  
Do not haul the chair itself or move with the casters on the floor where it easily gets scratches.  
Do not pull the power chord or remote control chord with leg or wrap with caster.  
Failure to do so may cause injury.

Hold the footrest and backrest handles and lift up to carry (refer to the figure below)

- Since it is a heavyweight unit, it should be carried by 2 or more persons.
- Watch your steps carefully and lower it slowly.

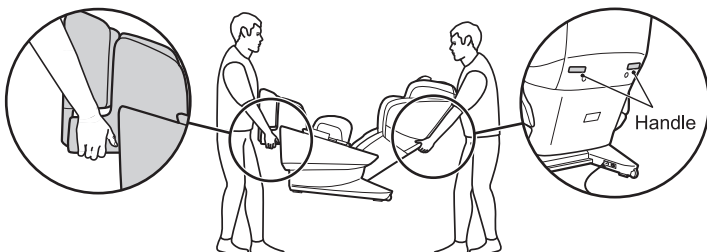

Frontage should be **72cm** or more (70cm width to carry the whole + 2cm width for protection)

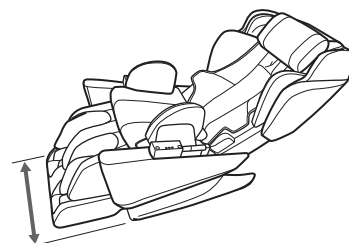

## Installation of arm unit ※Please install on both sides in the same way.

1. Move the mounting position of the arm unit to the front of the main body (①) and insert the convex part of the arm unit into the hole (②) of the mounting position.

- Install the arm unit while the back rest is in a reclined position
- Please insert firmly. Otherwise, there is risk of air leakage or falling.
- Please install on both sides in the same way.

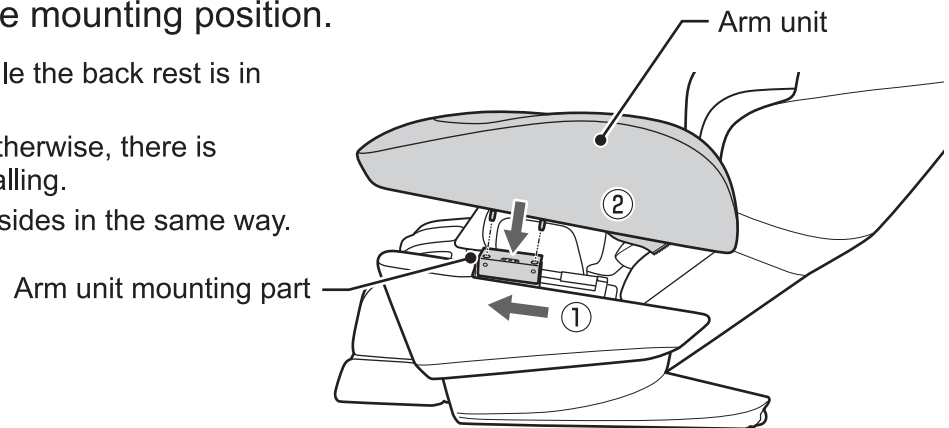

2. Align and close the fastener on the main body backrest and the arm unit one.

- Please install on both sides in the same way.

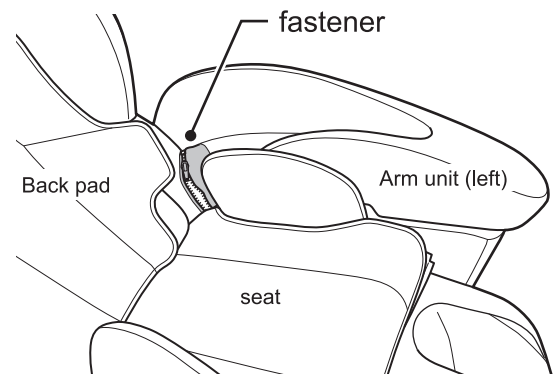

## Remote stand set up

1. Loosen the screw holding the remote holder, slide in the remote arm and gently tighten the screw back.

- The remote control holder breaks if fixing screw is tightened strongly.
- If the remote control stand is forcibly moved when the screw is tightened and fixed, this may cause an excessive load on the movable part and its fracture. Please pay attention to it.

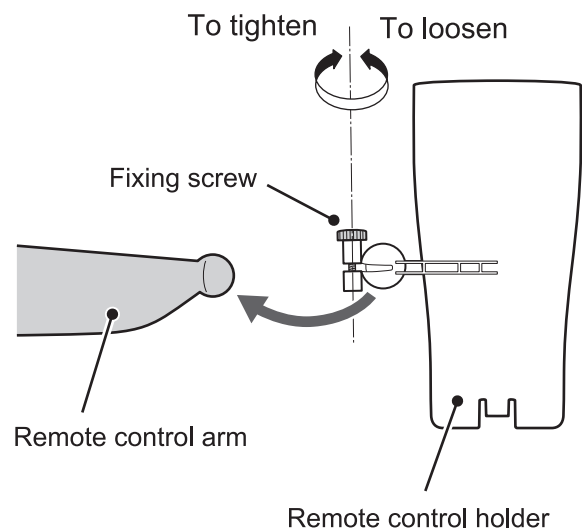
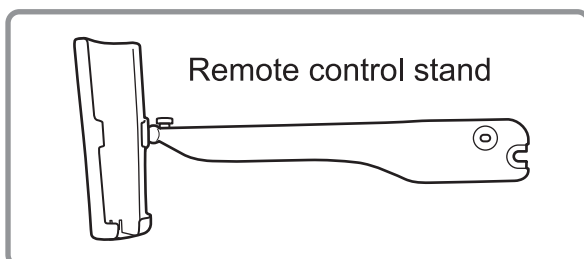

## Installation of remote control stand ※can only be installed on the right side.

1. Align the concave part (①) of the remote control stand with the convex part (②) of the main body and insert it between the cloth layers.

- The convex part of the main body is covered with cloth and is not visible. Please refer to the position in the right figure for insertion.

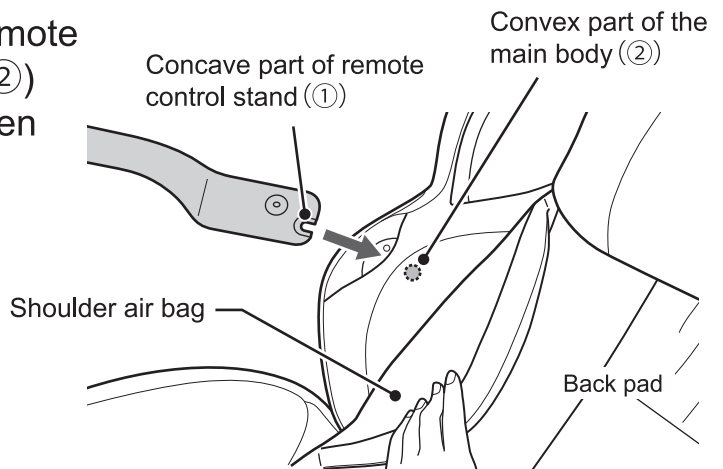

2. Align the remote control stand with the screw holes on the main body and fix it with screws.

- Please tighten the screw. If not tightened, the remote control stand may fall off, causing failure or injury.

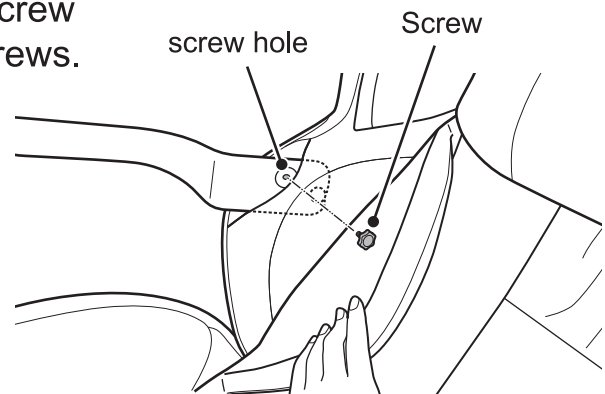

## Fixing the Remote control

### [Fixing method]

Remote control should be inserted from the top.

### [Removing method]

Remote control should be pulled out from the top.

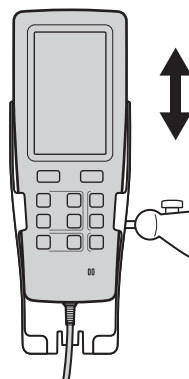

### [Adjustment method of remote control holder]

Fixing screw is bent and fixed in preferred position.

- ※The remote control holder breaks if fixing screw is tightened strongly.
- ※If the remote control stand is forcibly moved when the screw is tightened and fixed, this may cause an excessive load on the movable part and its fracture. Please pay attention to it.

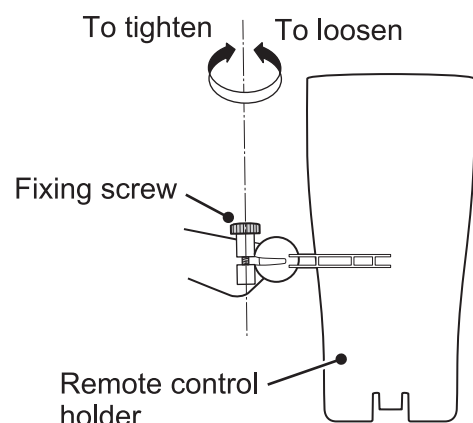

To remove the arm unit

1. Recline the backrest and open the fastner (①) holding arm unit and backrest.
2. Slide the arm unit towards the backrest, push downwards the stopper that is in between the arm unit and seat (②) and release the lock.
3. Move the arm unit towards the legs part, push the stopper (③) downwards and release the lock.
4. Lift and remove the arm unit.

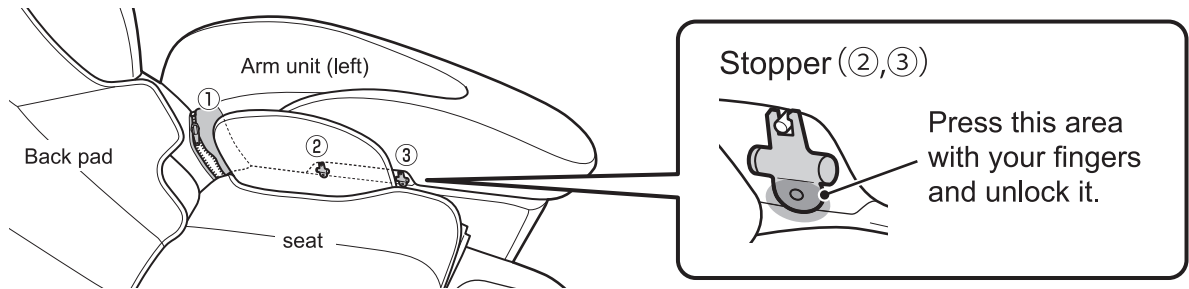

Method to remove the pillow and adjustment of back pad

1. The pillow is fixed to the backrest with velcro tape.

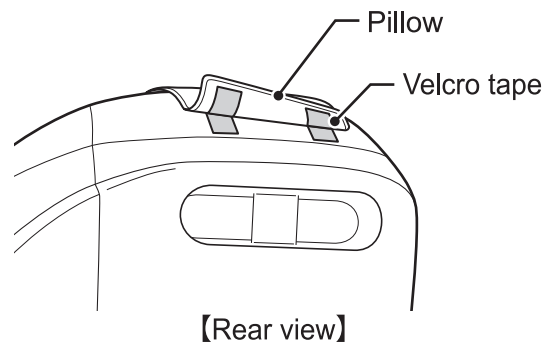

2. Adjust the back pad for your preference.

- Cap Back pad can be used as heater. Refer to "Position the back pad (heater part)" for more details. (P49)

If you want to attach the back pad firmly, fix the packrest and back pad with fastener.

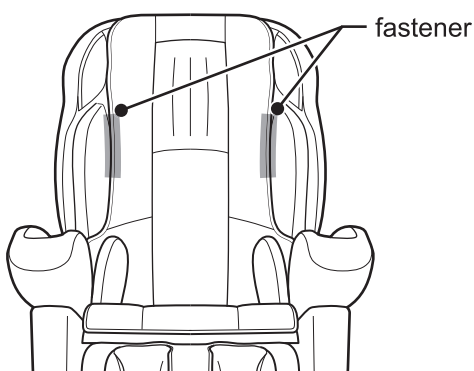

Center of back pad is removable. You can feel stronger massage when you remove it.

- ① Raise the fastener on the back of the back pad.
- ② Remove the velcro on the back of the back pad.

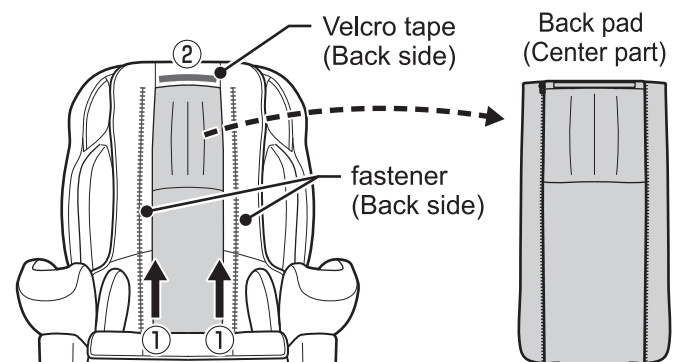

## Mount the power cord

### **!** DANGER

Do not use the chair other than on the designated voltage. Fire or electrification may occur. Insert the power plug and connector to the root without fail and do not allow dust to adhere. Failed to do so may cause electric shock, short circuit, or ignition. Do not use damaged power plug or power cord. It may cause electric shock, short circuit, or fire. If it is damaged, contact your retailer or our customer care for repair.

### 1. Insert the connector of the power cord into the inlet (power cord insertion port) at the lower right of the rear side of the main body.

- Insert it firmly.
- Do not use any electrical cables other than the supplied cord.
- Check that the power cord, remote control cord, or power plug is not damaged or that there is no dust on the power plug.

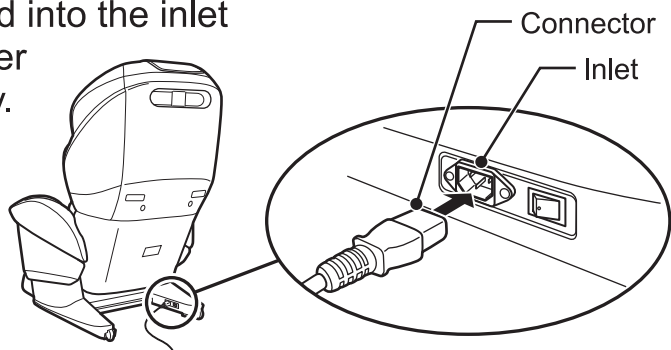

## Grounding instructions

### **!** DANGER

Improper connection of the equipment-grounding conductor can result in a risk of electric shock. Check with a qualified electrician or serviceman if you are in doubt as to whether the product is properly grounded. Do not modify the plug provided with the product – if it will not fit the outlet, have a proper outlet installed by a qualified electrician.

### **!** WARNING

Ground should be installed firmly. When the ground is not installed, it may cause electric shock at the time of trouble and short circuit.

※ This product must be grounded. If it should malfunction or breakdown, grounding provides a path of least resistance for electric current to reduce the risk of electric shock. This product is quipped with a cord having an equipment-grounding conductor and a grounding plug. The plug must be plugged into an appropriate outlet that is properly installed and grounded in accordance with all local codes and ordinances.

### Grounding methods

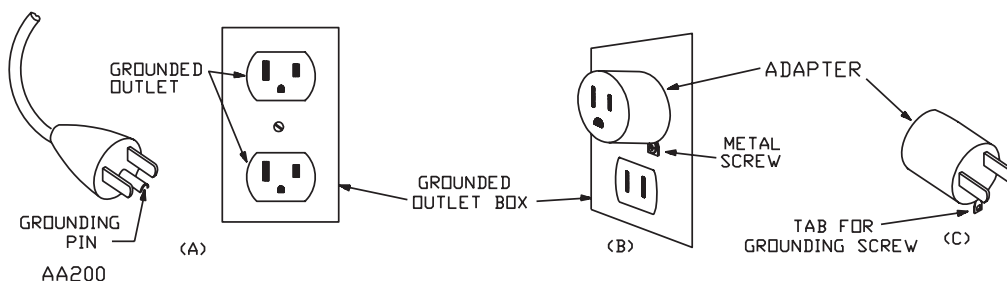

※ This product is for use on a nominal 120-V circuit, and has a grounding plug that looks like the plug illustrated in sketch A in Figure 86.1. A temporary adapter that looks like the adapter illustrated in sketches B and C may be used to connect this plug to a 2-pole receptacle as shown in sketch B if a properly grounded outlet is not available. The temporary adapter should be used only until a properly grounded outlet (sketch A) can be installed by a qualified electrician. The green colored rigid ear, lug, or the like extending from the adapter must be connected to a permanent ground such as a properly grounded outlet box cover. Whenever the adapter is used, it must be held in place by a metal screw.

### When there is no ground terminal in the power outlet

Before purchase, discuss with electric shop, dealer and do the grounding (D-Class<Class-D> installation work/cost).

# Before starting massage every time

## Check around the chair

### Check the surroundings without fail

- Check to make sure that there is nobody, no pet and nothing ahead behind the chair and under the footrest.

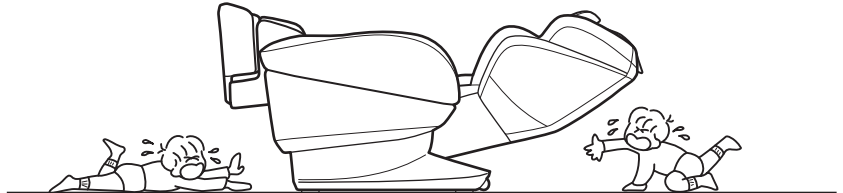

## Switch on the power

### ! DANGER

Do not use the chair other than on the designated voltage. Fire or electrification may occur. Insert the power plug firmly so that no dust is accumulated. Failed to do so may cause electric shock, short circuit, or ignition. Do not use damaged power plug or power cord. It may cause electric shock, short circuit, or fire. If it is damaged, contact your retailer or our customer care for repair.

### 1. Insert the power cord plug in the receptacle.

- Check that there is no damage in the power cord, remote controller cord, and the power cord plug. And there is no dust accumulated in the power cord plug.

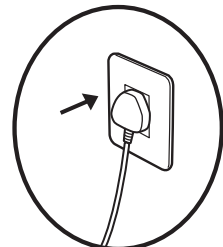



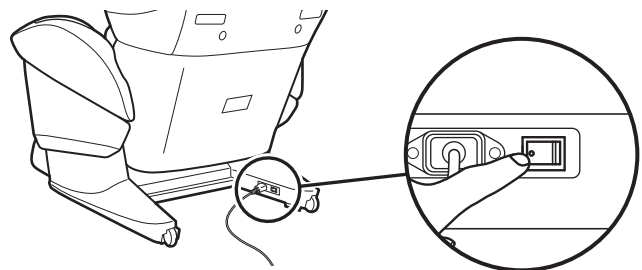

### 2. Switch "ON" power of main body.

- The power switch is behind the main body on the right bottom.



### 3. Press power button of remote controller to switch on the power.

- Regular screen is displayed.
- The seat back is reclined and footrest is raised till standby position automatically.  
(When reclining angle of   or footrest angle of   or  is pressed, it is stopped)
- When it is not operated for around 3 minutes or more, power supply will be turned off automatically.

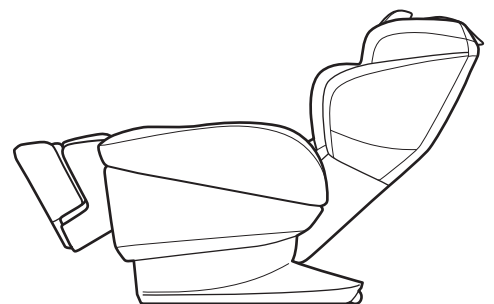

Standby position

- When regular screen is not displayed even if power is switched on by pressing the power button, the chair cannot be operated.



## Check the main body

### 1. Check for torn on the cover cloth.

#### **DANGER**

Before use, hold the back pad and make sure that there is no tear on the cover cloth of the backrest and on the other parts. (Should there be any tear, no matter how small it is, discontinue using the chair immediately. Disconnect the power cord plug, and ask for repair.) Continued use with the torn cloth may cause electric shock or any hazard on the body.

### 2. Check for trapping of foreign substance to the main body.

#### **WARNING**

Before use, check that there is no foreign substance trapped on to the main body (Backrest, footrest, armrest). Failed to do so may cause accident or injury.

### 3. Check whether the knead ball is in the retracted position.

- When the knead ball is not in the retracted position, it can be returned by pressing  button.

#### **WARNING**

Before seated on the chair, check whether the knead balls are in the retracting position. Failed to do so may cause accident and injury.

### 4. Check whether the footrest is in completely lowered

- When the footrest is raised, it can be lowered down by pressing footrest angle .

#### **WARNING**

Do not get on and off the chair at the time of reclining or when the footrest is raised. The chair may overturn and the user may fall down and hurt himself/herself.

# About the massage chair 2 Modes

This product has 2 modes available for use: Guest Mode, User Customized Mode.

For the functions available in each mode, please refer to the table on the specification page. (P73)

## Guest Mode (P20~55)

- After the power is turned on, the menu screen will be displayed and it will automatically enter Guest Mode.
- In Guest Mode, massage can be performed directly without registering the customized information in advance. Every time it is used, the machine will perform reclining adjustment and body shape detection.

※In User Customized Mode, as long as you have registered the customized information, you can omit reclining adjustment and body shape detection.

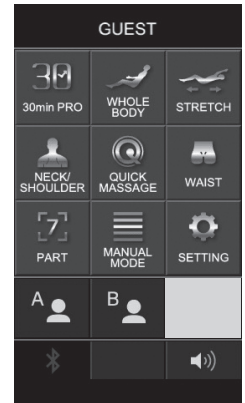

## User Customized Mode (P56~62)

- User information registration/customize can be done for up to 2 users.
- The user can register customized information when uses the device for the first time. After the registration is complete, the machine will start the automatic course according to the registered customized information. Body shape detection and adjustment can be skipped.

※If you want to switch from User Customized Mode to other modes, please restart the power before operation.

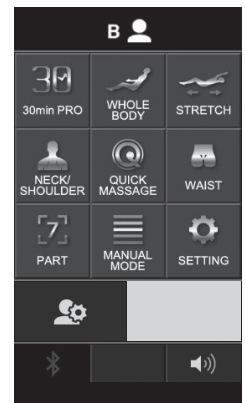
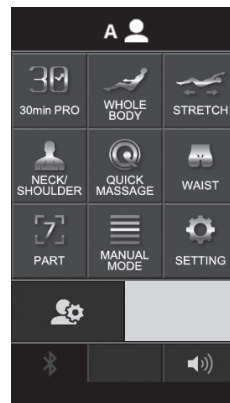

Registrable customized information (User Customized Mode)

Customize back line

**Shoulder / waist position information**

Shoulder / waist position information  
Select the massage point of the automatic course.

**S-curve detection information**

In order to make the massage chair massage evenly along the back, this function will collect back line information. The detected back line data can also be further edited according to preferences.

Customize reclining

**Reclining information**

It is possible to register information of the preferred backrest angle, leg angle / leg length.

Customize airbags pressure

**Air pressure information**

After the pre-setting, it is possible to register information of the preferred air massage intensity.

Customized information first registration example

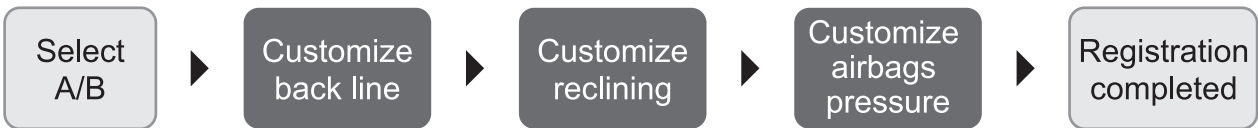

Example of each massage operation (Auto Mode course)

Guest Mode



User Customized Mode

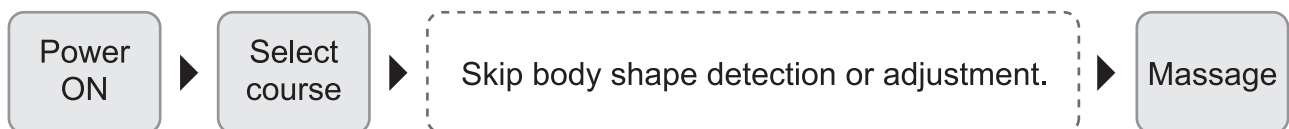

# Adjust the reclining and footrest angle / Usage of the arm part

## DANGER

Check to make sure that there is nobody, no pet and nothing ahead around the chair (back, front, side, and bottom part of main body) when reclined or footrest is moved. Failed to do so may cause accident or injury or damage of house holding.

When reclined or footrest is moved, make sure not to insert the hand, finger, leg or head in the gaps of main body which are mentioned below.

- Bottom side of chair ● Gap of armrest, backrest, and seat. ● Gap of armrest, leg and seat .
- Bottom side and back side of leg. ● Gap of armrest and arm. ● Backside gap of backrest.

Failed to do so may cause accident or injury

## WARNING

Do not place your leg or hand in the footrest adjustable place, when footrest is adjusted. It may cause accident or injury.

Do not attempt to ride on the front portion of footrest or seat pad at the time of reclination.

The chair may overturn and the user may fall down and hurt himself/herself.

Do not get on and off the chair at the time of reclining or when the footrest is raised.

The chair may overturn and the user may fall down and hurt himself/herself.

## Adjust the footrest angle and length

### 1. Adjust the footrest angle by pressing footrest angle button.

- When foot air is on, footrest will not be lowered till the retracted position
- Turn "OFF" the footrest air to lower the footrest till retracted position. (Refer Page 35)

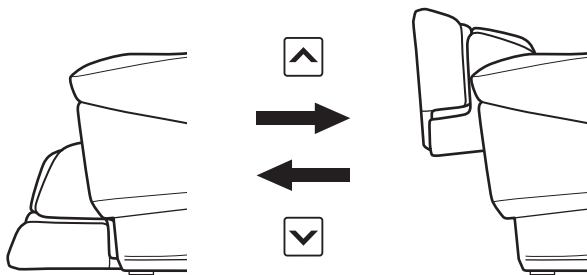

### 2. Adjust the footrest length by pressing the footrest expansion buttons.

- Flexibility function can be used when footrest angle is 25 degree or more.
- Footrest length to be stretched changes in accordance with footrest angle.

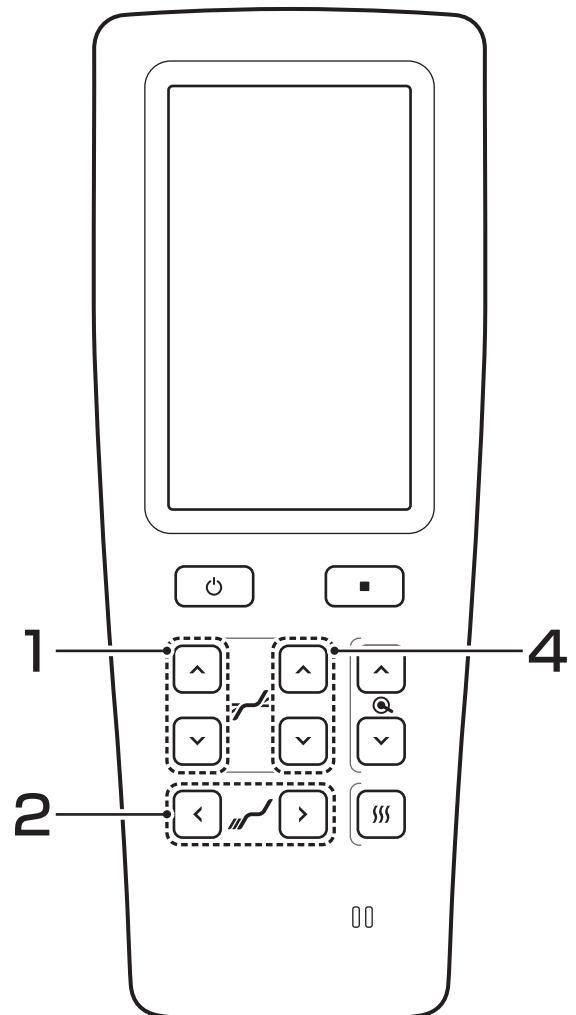
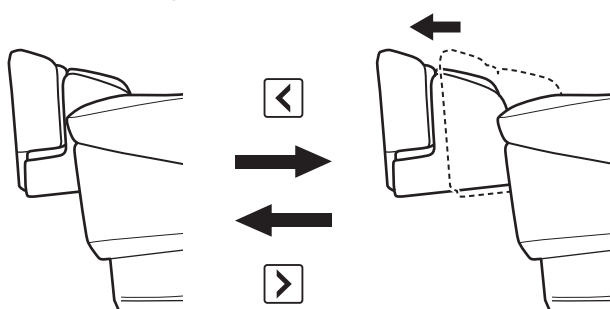

### 3. Stretch the sole and adjust the footrest length.

- Sole can be stretched or contracted by the spring. Press it with the leg.
- When returning the footrest to its original position, avoid applying force to the soles of the feet. If the footrest is moved back to position when the springs are extended, the sole part might hit the floor and then it won't be possible to smoothly put the footrest back into position.

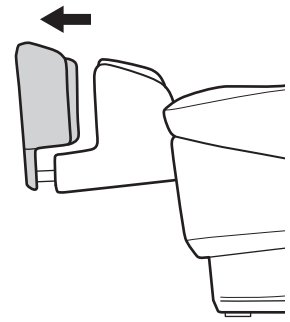

## How to adjust reclining angle

### 4. The Reclining angle can be adjusted by pressing reclining button..

- Rather than falling down, irritability of the knead ball will be more.
- The recliner is interlocked, the footrest raises and armrest moves.

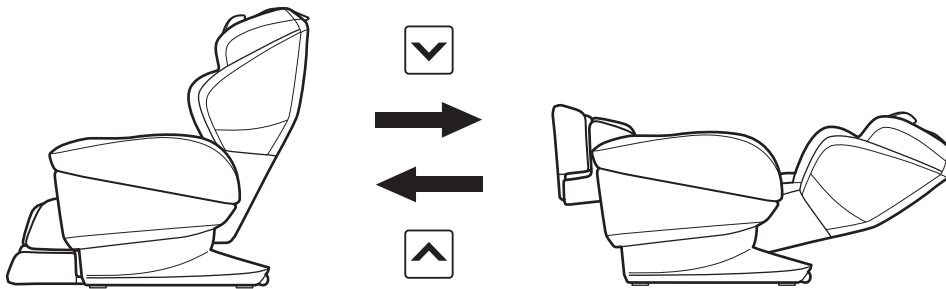

## Usage of the arm part

### **WARNING**

Do not use the hand/arm massage whilst wearing watches, rings, fake fingernail or bracelets. This may cause injury.

### 5. Straighten your fingers, stand your palms vertically and put your hands in.

- Do not put your hands in horizontally or with your fingers bent.

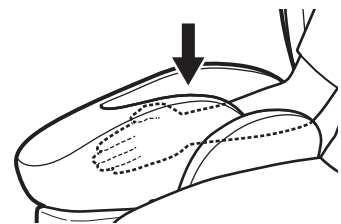

### If you want to adjust the position of the arm (arm unit)

- You can adjust the position by sliding the arm part when the backrest is tilted. After the backrest is tilted, slide the arm part towards the backrest (manual).
- The larger the tilt angle of the backrest, the further the arm can be slid to the side of the back cushion. When the backrest is in the stowed position (completely upright), the arm cannot be slid.

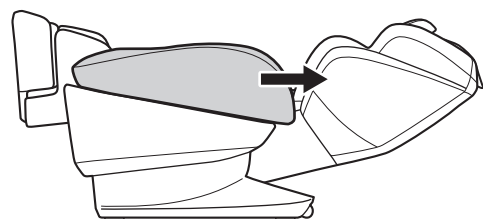

# Massage by Auto Mode Course



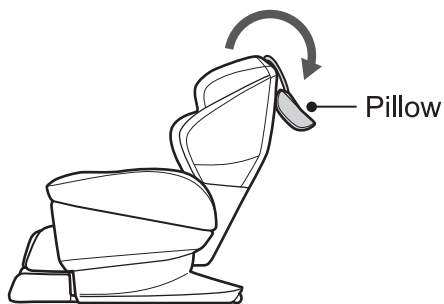

## Introduction

- Please set the power switch of the main body to "ON".
- Put the pillow back, sit on the chair and slowly lean your head against the backrest. If you want to soften the massage feeling, add and use the pillow according to your preferences.



## Auto Mode Course starts

### 1. Switch ON the Power by pressing

- Regular screen is displayed.
- The seat back is reclined and footrest raises automatically up to the standby position.  
(When reclining angle of   or footrest angle of   or  is pressed, it is stopped)
- If the machine is not operated for more than 3 minutes, then it is switched OFF automatically.

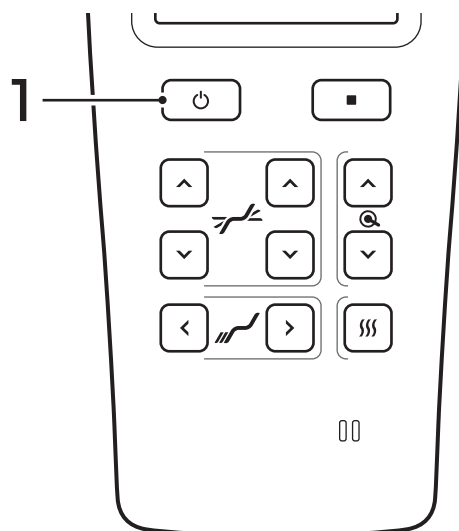

### 2. Select and press from these

      Buttons.

Choose the preferred course and press the button.

- When the backrest is upper or footrest is lower than standby position, the backrest and footrest move to standby position.

[Example] When "REFRESH" course of Whole body is selected.

- ① Press 
- ② Select the REFRESH

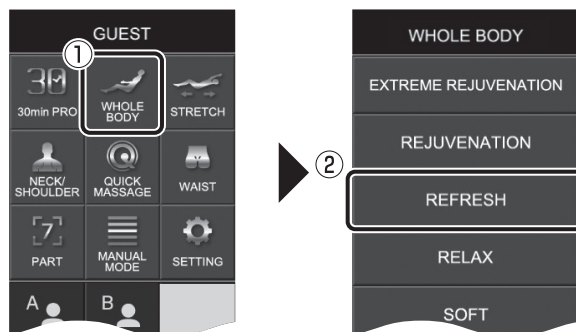

### 3. Start the Double Sensing (Body Shape Detection)

- The kneading balls move from the stowed position.
- Sit back firmly and lean the head towards backrest while sensing.
- Do not pull head off the backrest.
- There are some courses that the sensing is not given.

#### About Double Sensing (Body Shape Detection)

Double sensing is the function to detect body shape or posture before starting massage. The effective massage is given by 2 sensors, one for 「S-shaped line detecting system」which detect one's back/spine, another for 「Shoulder position detecting system」which detect one's shoulder position.

4. Automatic shoulder position detection starts. After detection is complete, press the "OK (①)" key. If it is inconsistent with the actual shoulders position, please press the "Re-detection" (②) key or the "Manual Adjustment" (③) key to adjust.

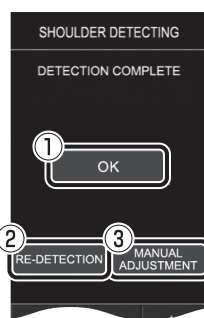
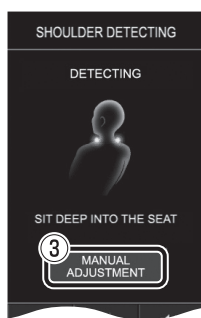
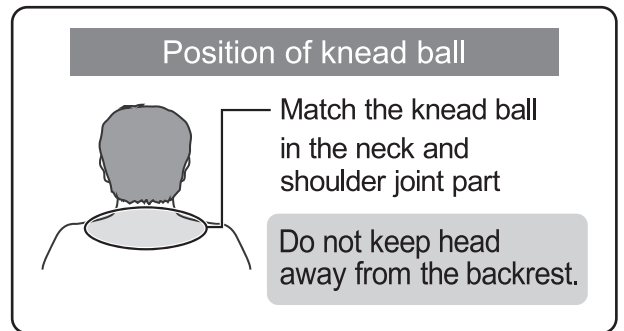

Shoulder position manual adjustment

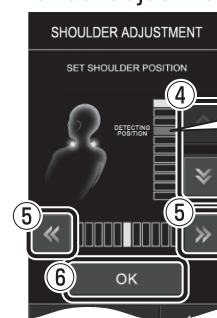

Aiming position during auto detection is displayed in red.

- Even if **OK** is not pressed, the massage starts after about 10 seconds.
- Detection starts again when press 「RE-DETECTION」.
- Shoulder position can be adjusted by pressing [MANUAL ADJUSTMENT] during or after the detection. Adjust **▲ ▼** (④) for vertical position, **◀ ▶** for back and forward position, then press **OK** (⑥).
- Shoulder position detection measures vertical position. back and forward position can be adjusted by 「MANUAL ADJUSTMENT」 or Shoulder position adjustment after starting massage.

5. After the shoulders position is detected, the back line detection starts. After detection is complete, press the "OK" (①) key.

- Do not keep head away from the backrest.
- Even if **OK** is not pressed, the massage starts after about 10 seconds.
- Press the "Re-detection (②)" key to detect the back line again.
- In case of detection error, press "Re-detection".

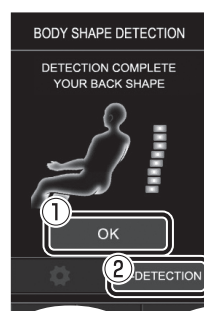

Error



## 6. Selected auto course and massage operations are displayed.

- Refer to "Adjustment during auto course method" for the changes done in the settings during auto course.

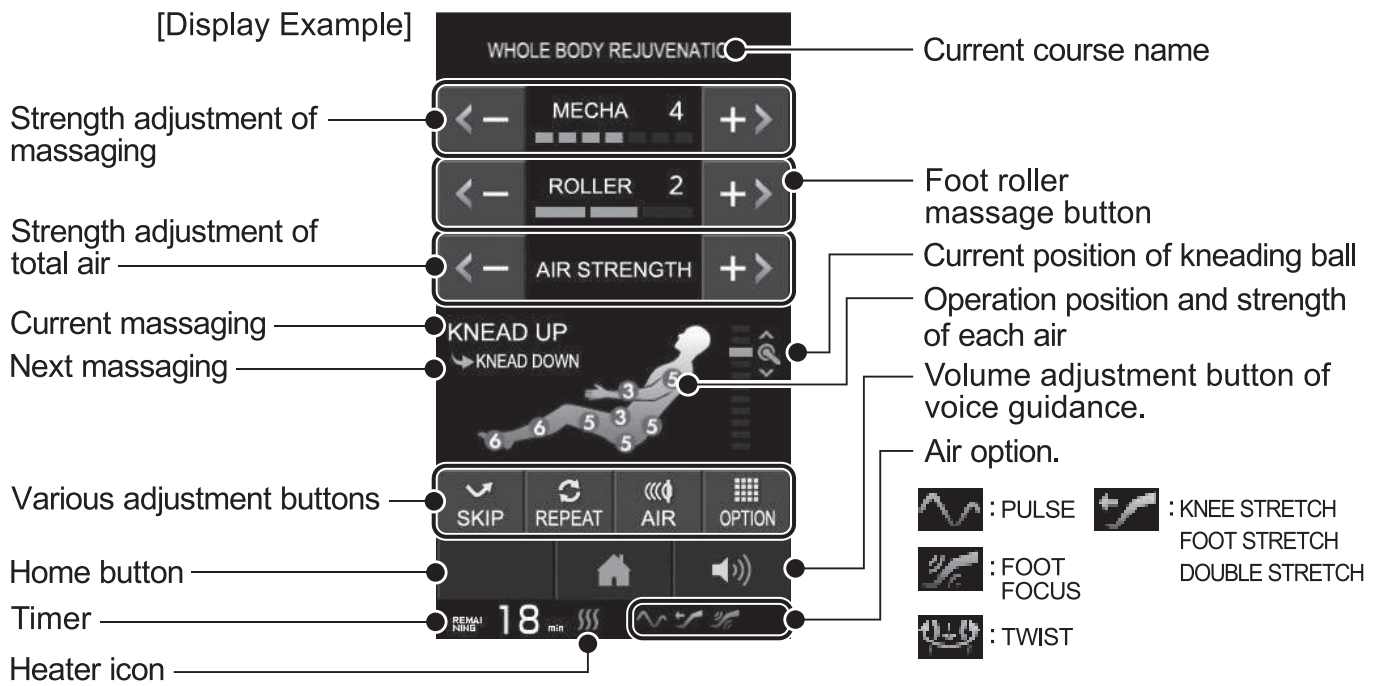



## About the operation of auto course

The list of details that can be adjusted during the description of each auto course and during the start or in the middle of the course.

Course	Course details	Spinal column line auto detect	Shoulder auto detect	Rubbing ball	Air massage strength	Skip/repeat	Adjust the shoulder position	Adjust the waist position	Option	
30min PRO	VIP	Rejuvenating	●	●	●	●	-	●	●	-
	SOMMELIER	Perfect	●	●	●	●	-	●	●	-
	NIGHT HEALING	Refreshing	●	●	●	●	-	●	●	-
	CONDITIONING	Refreshing	-	●	●	●	-	-	-	-
	MINDFULNESS	Relaxing	-	-	-	●	-	-	-	-
WHOLE BODY	EXTREME REJUVENATION	Rejuvenating	●	●	●	●	●	●	●	●
	REJUVENATION	Perfect	●	●	●	●	●	●	●	●
	REFRESH	Rhythmical	●	●	●	●	●	●	●	●
	RELAX	Refreshing	●	●	●	●	●	●	●	●
	SOFT	Light massage	●	●	●	●	●	●	●	●
NECK/SHOULDER	EXTREME REJUVENATION	Rejuvenating	●	●	●	●	●	●	●	●
	REJUVENATION	Perfect	●	●	●	●	●	●	●	●
	REFRESH	Rhythmical	●	●	●	●	●	●	●	●
	RELAX	Refreshing	●	●	●	●	●	●	●	●
WAIST	EXTREME REJUVENATION	Rejuvenating	●	●	●	●	●	●	●	●
	REJUVENATION	Perfect	●	●	●	●	●	●	●	●
	REFRESH	Rhythmical	●	●	●	●	●	●	●	●
	RELAX	Refreshing	●	●	●	●	●	●	●	●
STRETCH	EXTREME WHOLE BODY STRETCH	Rejuvenating	-	●	●	●	-	-	-	-
	WHOLE BODY STRETCH	Perfect	-	●	●	●	-	-	-	-
	WHOLE BODY AIR	Massage only with air	-	-	-	●	-	-	-	●
	Technical Stretch	Site-specific stretching	-	●	●	●	-	-	-	-
7min	QUICK MASSAGE	Quick relax	●	●	●	●	-	●	●	●

※Spinal column line cannot be adjusted

## Adjustment during auto course method

### To adjust the strength of mecha massage

① Adjust the mecha strength by using **+>** for increase and by using **<-** for decrease.

- Strength can be selected from 7 steps.
- The initial setting is set in "4". (Only software is set to "2".)



### Adjustment method during air massage

[In the case whole adjustment]

① Total Air strength can be reduced with **<-** and increased with **+>**.



[In the case part by part adjustment]

① Press the "AIR"  
 ② Select the preferable strength part by part.  
 Can be reduced with **<-** and increased with **+>**.

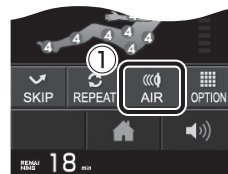

③ Return to course screen by pressing **OK**

- Even if **OK** is not pressed, it will be set after 10 seconds approximately.
- There are 7 levels of intensity to choose from. The initial setting level is "4" (the initial setting level of the soft course is "3"). On the first page, "shoulder, arm, waist and pelvis", on the second page, "hip, thigh, calf and ankle" can be adjusted. Press **<<** **>>** keys to switch the page.
- "OFF" can be set in part wise. If the **<-** is pressed when the strength is "1", it will be set to "OFF".

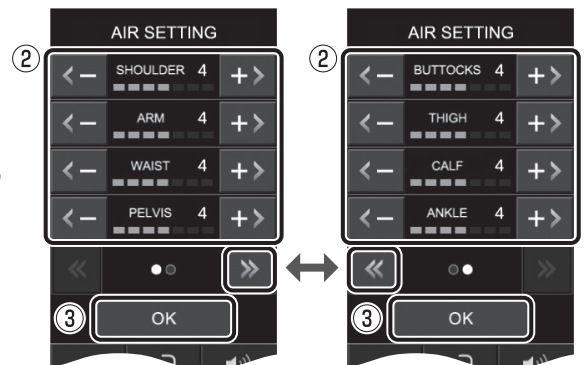

### To proceed from current knead massage and to repeat the current knead massage

① When you want proceed from current knead massage, and press "SKIP"

② When you want repeat from current knead massage, and press "REPEAT"

- Air massage cannot skip and repeat.
- While pressing the repeat, the current massage will be continued for 30 seconds.
- During repeat, if press skip the repeat will be released.



## To adjust the shoulder position (Front/back) and waist position (Up/down)

- ① When the mecha position come near by the shoulder or waist, press the of mecha position
- ② The mecha position is adjusted by using (front/back position of shoulder) or (Waist position).
- ③ Press **OK**
  - Even if is not pressed, it will be set after 10 seconds approximately.
  - The front back position of shoulder/ waist position will be reflected in neck and shoulder pro technique/ back and waist pro technique.

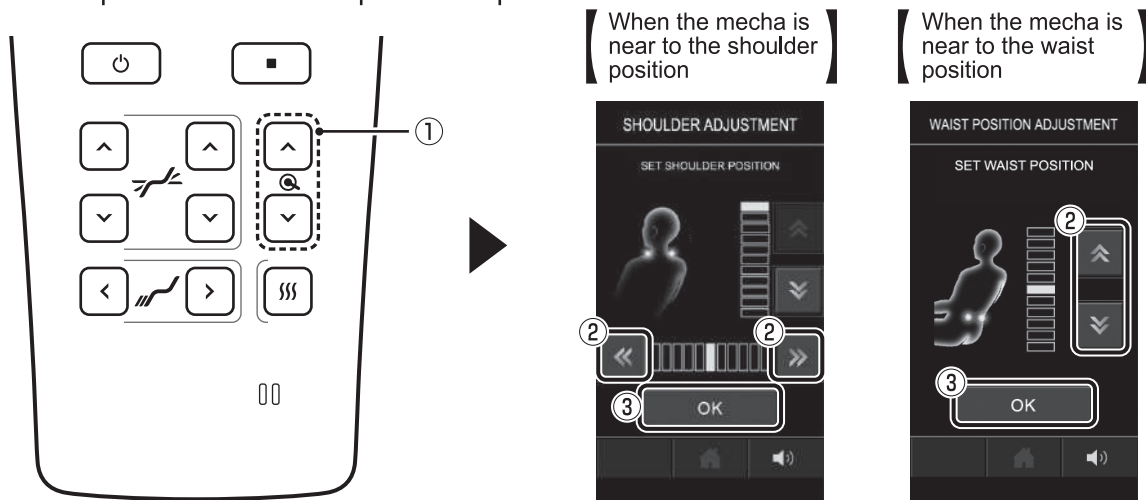

## To set the airbags intensity

- ① Press “OPTION”
- ② Select “OFF / PULSE”
- ③ Return to course screen by pressing **OK**
  - Even if **OK** is not pressed, it will be set after 10 seconds approximately.

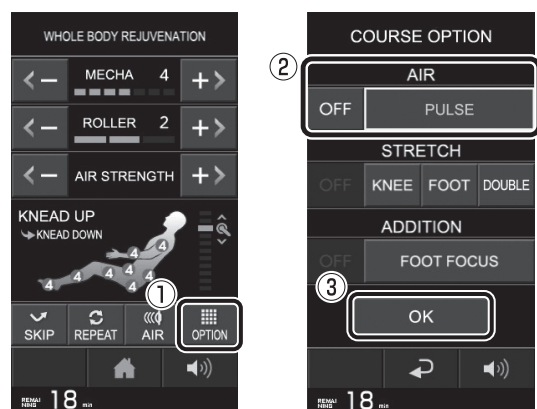

### To set stretch operation

- ① Press "OPTION".
- ② Select "OFF / KNEE / FOOT / KNEE&FOOT".
- ③ Return to course screen by pressing **OK**.

- Even if **OK** is not pressed, it will be set after 10 seconds approximately.
- When the stretch operation is selected, if the foot rest top angle is less, operation will begin after raising stretch operation up to possible angle.
- Multiple stretch operations cannot be set simultaneously.
- Stretch operation and "CALF" cannot be set simultaneously.

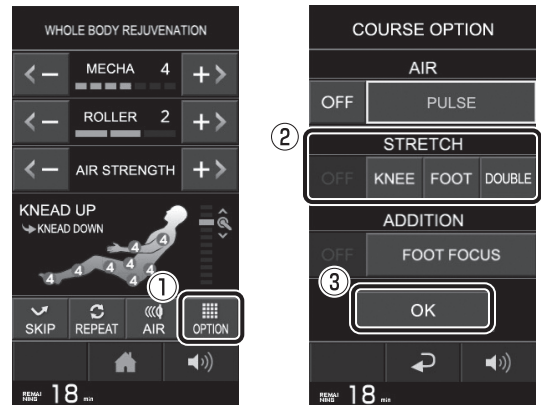

### To set individual operation

- ① Press "OPTION".
- ② Select "OFF / FOOT FOCUS".
- ③ Return to course screen by pressing **OK**.

- Even if **OK** is not pressed, it will be set after 10 seconds approximately.

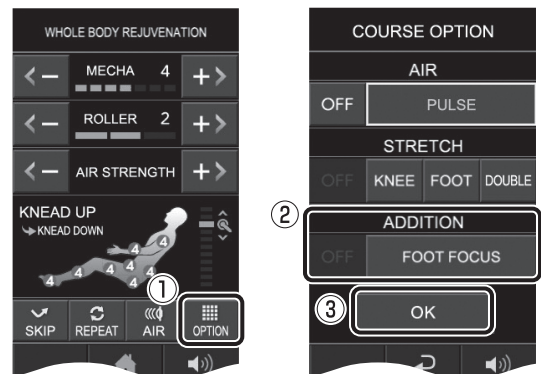

### To adjust foot roller massage

- ① Foot roller strength can be reduced with **←** and increased with **→**.
  - Default setting of strength is [2].
  - "OFF" can be set in part wise. If the **←** is pressed when the strength is "1", it will be set to "OFF".
  - Refer to [Foot roller massage].

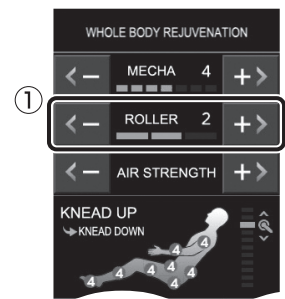

# MEMO

---

# About the end of Massage

## Massage time is different from each course

- The knead ball moves to storing position after finishing massage.
- When auto reclining is 「OFF」, return the angle of backrest and footrest to storing position during 「STORING」 is shown on the display.
- When auto reclining is 「ON」, backrest moves up and footrest moves down automatically.
- When no operation for about 30 seconds after massage, power supply will be cut.

Course Selection	Massage time
Part massage Quick massage	7 minutes
Auto Course Manual Course	18 minutes
30 min PRO course	30 minutes

When returning the footrest to its original position, avoid applying force to the soles of the feet. If the footrest is moved back to position when the springs are extended, the sole part might hit the floor and then it won't be possible to smoothly put the footrest back into position.

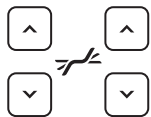
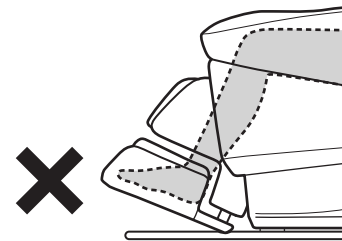

You can adjust the backrest and leg angle. (①)

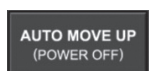

The backrest gets up, The legs are stowed. (②)

When the massage is over

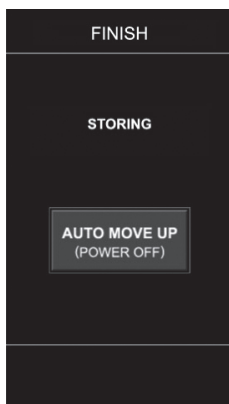

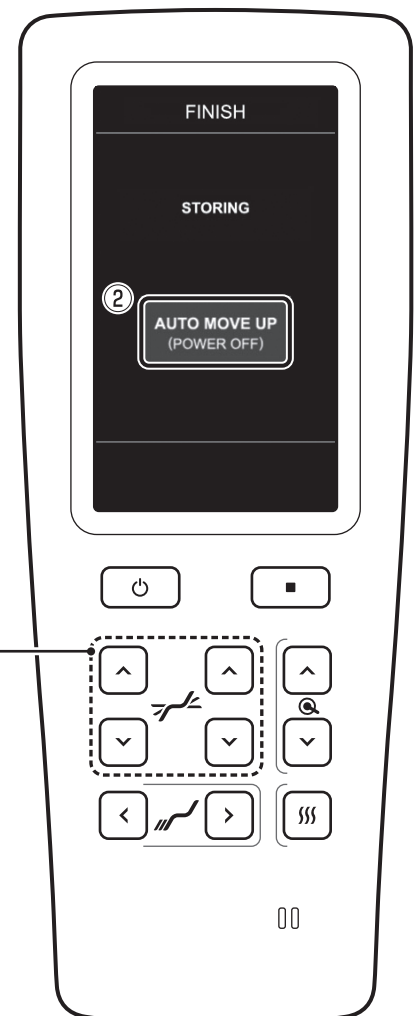

Power OFF



## When massage is stopped as such

Press  (①) or  (②)

- The knead ball is stopped in the current position as such
- If  or  is pressed you will return to regular screen but the timer will continue.

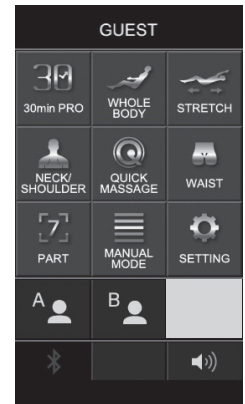
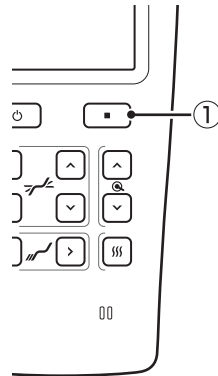

## When massage is to be stopped suddenly

Press 

- Knead ball moves till retracting position
- When "STORING" screen is displayed then restore the recliner and angle of footrest

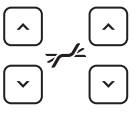

You can adjust the backrest and leg angle.

**AUTO MOVE UP**  
(POWER OFF)

The backrest gets up,  
The legs are stowed.

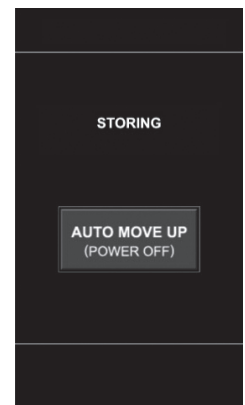
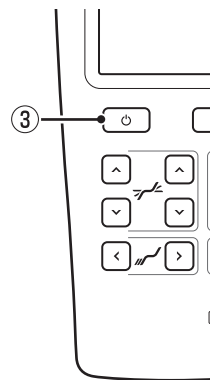

## Disconnect the power of Main Body

### 1. Switch OFF the power of the main body

- The power switch is in the lower right part behind the main body.

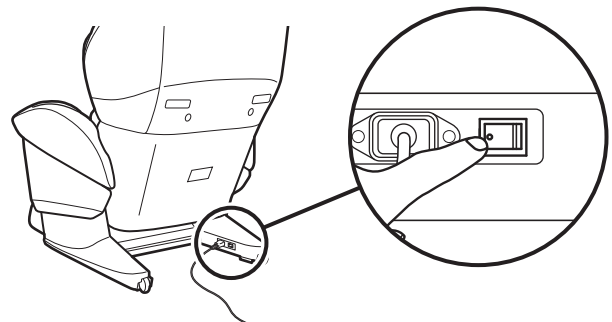



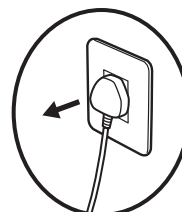

### 2. Remove the Power cord plug from receptacle



# Rubbing massage

## Start the desired rubbing massage

### 1. Switch ON the Power by pressing

- Regular screen is displayed.
- The seat back is reclined and footrest raises automatically up to the standby position.  
(When reclining angle of   or footrest angle of   or  is pressed, it is stopped)
- If the machine is not operated for more than 3 minutes, then it is switched OFF automatically.

### 2. Select .

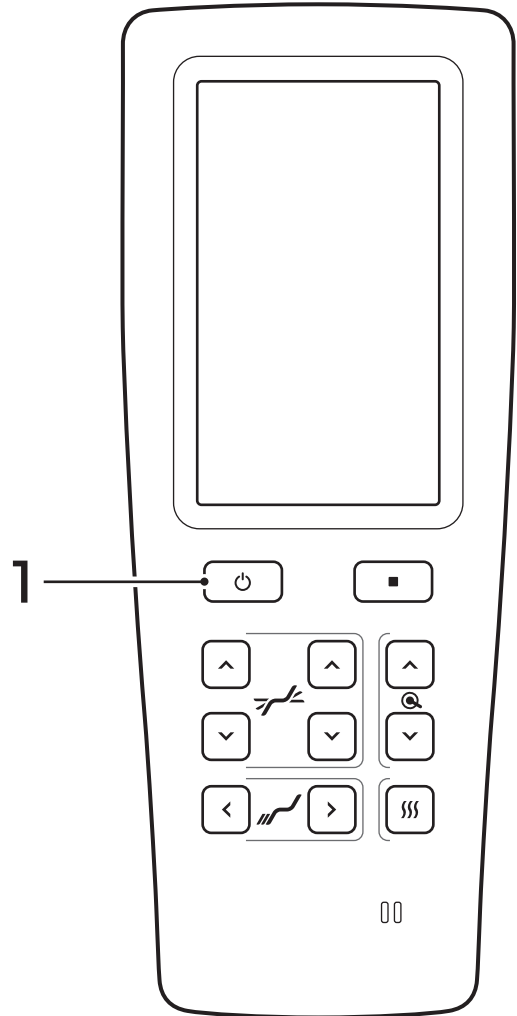

### 3. Select the desired massaging menu.

### 4. Select the desired massaging.

- Start the Massage

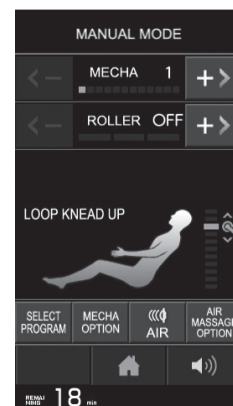
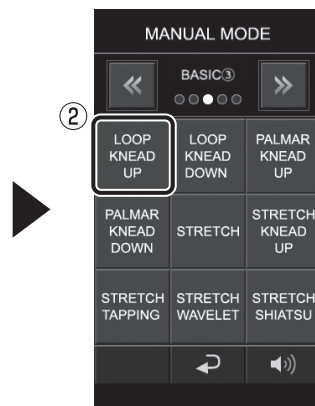
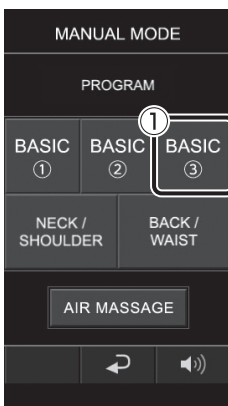



## 5. Set the massage action range. Select "Whole" to start detection of the shoulders position.

For the setting of action range, please refer to "To select action range (point/part/whole)" (P34).  
For massage with adjustable action range, refer to "List of kneading techniques massage" (P36).

### [Shoulder position adjustment]

- The mecha is moved to shoulder position and shoulder position detection starts. After completing detection, Massage starts **OK** (1) is pressed. When the shoulder position is not matching adjust using "RE-DETECTION (2)" or "MANUAL ADJUSTMENT (3)".
- Even if "START" is not pressed, it will be started after 7 seconds approximately.
- The shoulder detection starts once again if "Redetect" is pressed.
- Shoulder position is manually adjusted if "MANUAL ADJUSTMENT" is pressed. Up/Down position of Mecha is adjusted by **▲ ▼** (4), Front/Back position is adjusted by **◀ ▶** (5) Press **OK** (6).

During shoulder position detection



Shoulder position detection completion

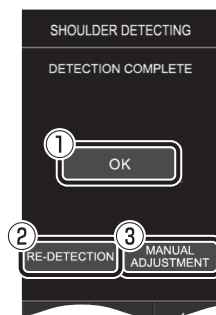

Shoulder position manual adjustment

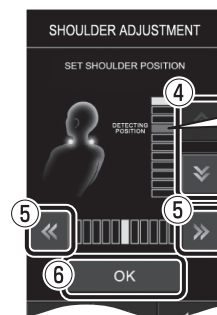

Aiming position during auto detection is displayed in red.

- Press the rubbing ball position **▲ ▼** (7) first, then use **◀ ▶** (8) to adjust the shoulder position front/back during massage. Press **OK** (9) after shoulder position adjustment.

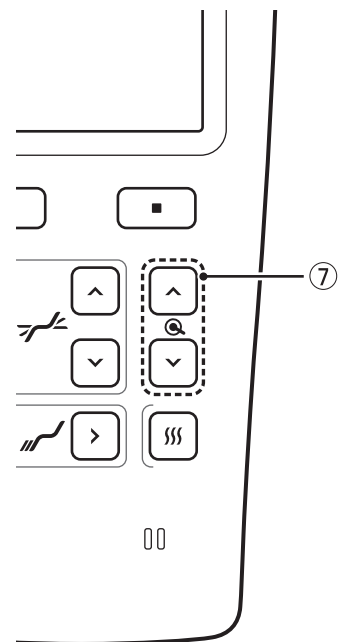
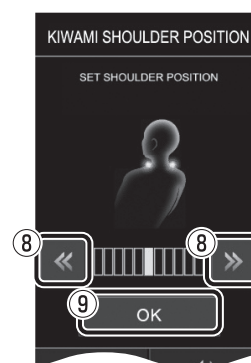

### [Waist position adjustment]

- Waist position is adjusted with rubbing ball position **▲ ▼** (7) or **◀ ▶** (10). Press **OK** (11) after waist position adjustment.

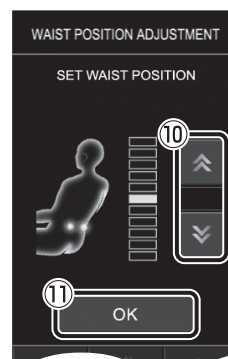

### [Massage position adjustment]

- Adjust the massage position using **▲ ▼** (7) of mecha position.

## How to adjust during massaging

### When you want to adjust the massage speed

- ① Select the "MECHA OPTIONS".
- ② Select the speed "SLOWEST/SLOW/NORMAL/FAST".
- ③ Press **OK**.

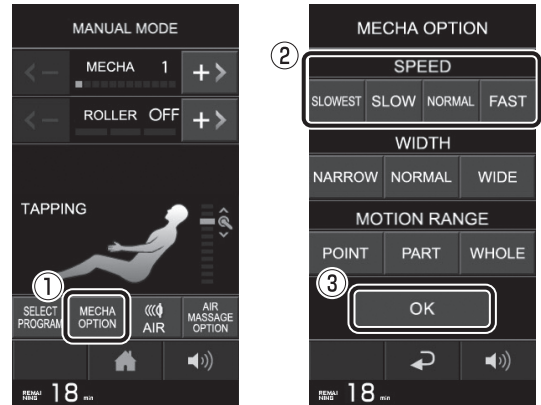

### When you want to adjust the rubbing ball strength

- ① Select the "MECHA OPTIONS".
- ② Rubbing width adjustment  
Select the "NARROW/NORMAL/WIDE".
- ③ Press **OK**.

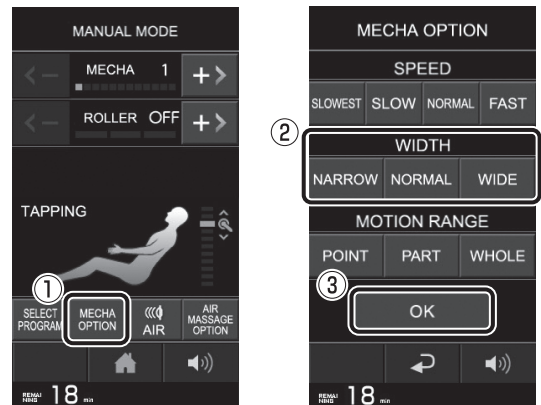

### When you want to select the massage region (Point/part/whole)

- ① Select the "MECHA OPTIONS".
- ② Select the motion range "POINT/PART/WHOLE".
- ③ Press **OK**.

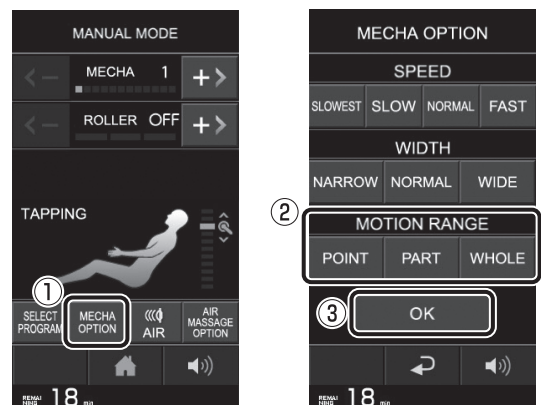

## To adjust the shoulder position (Front/back) and waist position (Up/down)

- ① Knead ball position is pressed when mecha is near shoulder or waist.
  - ② Knead ball position is adjusted with (Shoulder front and back position) or (neck position).
  - ③ is pressed.
- Even if is not pressed, it will be started after 10 seconds approximately.
  - The shoulder front and back position/Waist position is reflected in neck and shoulder position/Back and waist position. Refer to "Mecha massage function list table" for details. (P36)

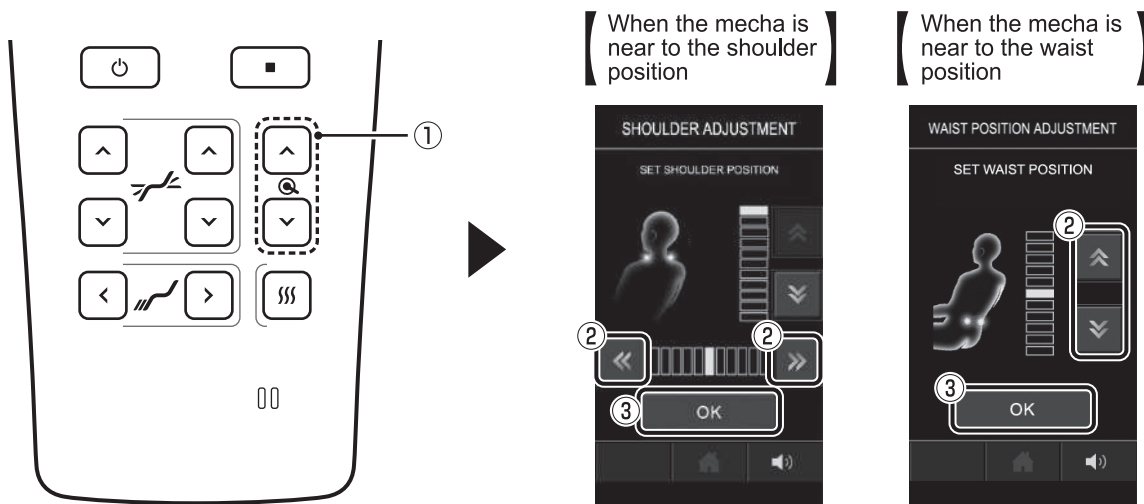

## To adjust the strength of mecha massage

- ① Adjust the back strength by using for increase and for decrease.

- Strength can be selected from 12 steps.
- The initial setting is set in "5".

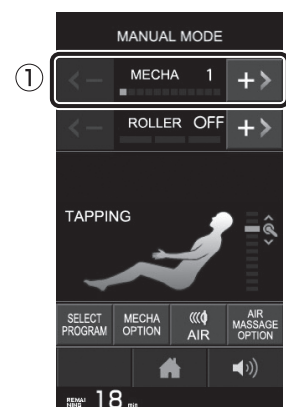

- There is an item which cannot perform Adjustment/Setting by selected rubbing technique. Refer "Mecha massage function list table" for details.

Mecha massage function list table





The list of adjustments that can be performed during each knead technique.

	PROGRAM	knead technique adjustment	Knead technique front and back adjustment	Mecha Strength	Massage speed	Mecha width	Combination of foot roller	Massage position
BASIC ①	KNEAD UP / DOWN	-	-	●	●	-	●	WHOLE/PART/POINT
	LIFT UP / PUSH DOWN	-	-	●	-	-	●	-
	WAVELET	-	-	●	●	-	●	WHOLE/PART/POINT
	IRREGULAR WAVES WAVELET	-	-	●	-	-	●	-
	RELAX KNEAD UP / DOWN	-	-	●	●	-	●	-
	RUBBING MASSAGE	-	-	●	●	-	●	-
	PUSH & KNEAD	-	-	●	●	-	●	WHOLE/PART/POINT
	SPIRAL KNEAD	-	-	●	-	2 levels	●	-
	PRECISION SPIRAL KNEAD	-	-	●	-	-	●	-
BASIC ②	SHIATSU	-	-	●	-	●	●	WHOLE/PART/POINT
	SHIATSU STRETCH	-	-	●	-	●	●	WHOLE/PART/POINT
	TAPPING SPIRAL KNEAD	-	-	●	-	-	●	-
	TAPPING PRECISION SPIRAL KNEAD	-	-	●	-	-	●	-
	TAPPING	-	-	●	●	●	●	WHOLE/PART/POINT
	ROLLING	shoulder position	●	●	-	●	●	PART/POINT
	PARASPINAL	shoulder position	●	●	●	-	●	-
	WAVE ROLLING	shoulder position	●	●	●	-	●	PART/POINT
	3D KNEAD UP / DOWN	-	-	-	-	-	●	WHOLE/PART/POINT
	3D TAPPING	-	-	-	-	●	●	WHOLE/PART/POINT
	3D WAVELET	-	-	-	-	-	●	WHOLE/PART/POINT
BASIC ③	LOOP KNEAD UP / DOWN	-	-	●	●	-	●	WHOLE/PART/POINT
	PALMAR KNEAD UP / DOWN	-	-	●	-	-	●	WHOLE/PART/POINT
	STRETCH	-	-	●	-	●	●	WHOLE/PART/POINT
	STRETCH KNEAD UP	-	-	●	●	-	●	WHOLE/PART/POINT
	STRETCH TAPPING	-	-	●	●	●	●	WHOLE/PART/POINT
	STRETCH WAVELET	-	-	●	●	-	●	WHOLE/PART/POINT
	STRETCH SHIATSU	-	-	●	2 levels	●	●	PART/POINT
NECK / SHOULDER	NECK UPWARD LIFTING	shoulder position	-	-	-	-	●	-
	COLLAR DOWNWARD PRESSING	shoulder position	-	-	-	-	●	-
	NECK RELAX	shoulder position	●	-	-	-	●	-
	NECK SHIATSU	shoulder position	●	-	-	-	●	-
	NECK / SHOULDER EXTREME KNEAD	shoulder position	●	-	-	-	●	-
	NECK / SHOULDER EXTREME TAPPING	shoulder position	●	-	-	-	●	-
	NECK PALMAR KNEAD	shoulder position	●	-	-	-	●	-
	TOP SHOULDER LINE SHIATSU	shoulder position	-	-	-	-	●	-
	UPPER SHOULDER PRESS	-	-	-	-	-	●	-
	SHOULDER TAPPING	shoulder position	●	-	-	-	●	-
BACK / WAIST	UPPER BACK DEEP SHIATSU	shoulder position	-	-	-	-	●	-
	LUMBAR DEEP SHIATSU	waist position	-	-	-	-	●	-
	SHOULDER BLADE LINE	-	-	●	-	-	●	-
	SHOULDER BLADE OPEN	shoulder position	●	●	-	-	●	-
	WAIST EXTREME KNEAD	waist position	-	-	-	-	●	-
	WAIST EXTREME TAPPING	waist position	-	-	-	-	●	-
	RHOMBOID	shoulder position	●	●	-	-	●	-
	WAIST SHIATSU	waist position	-	-	-	-	●	-
	WAIST PALMAR	waist position	-	●	-	-	●	-
BUTTOCK	-	-	-	-	-	●	-	

# Air massage

## Start air massage

1. Switch ON the Power by pressing 



- Regular screen is displayed.
- The seat back is reclined and footrest raises automatically up to the standby position.  
(When reclining angle of   or footrest angle of   or  is pressed, it is stopped)
- If the machine is not operated for more than 3 minutes, then it is switched OFF automatically.

2. Select 

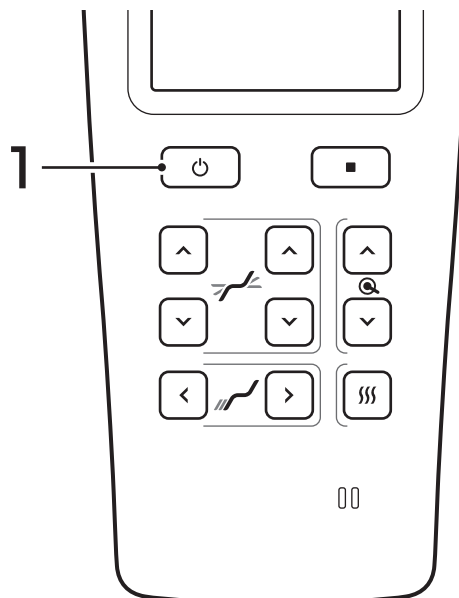
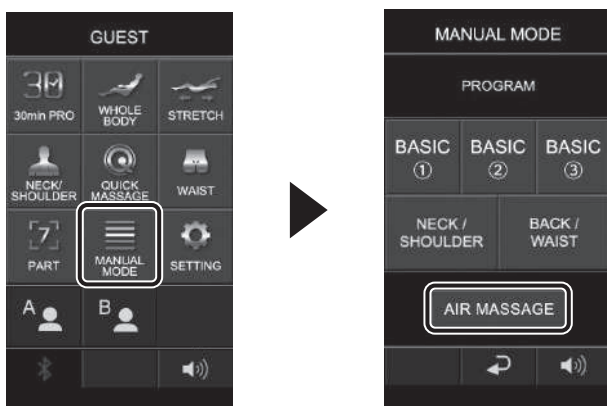
3. Select "AIR MASSAGE"



4. Select the desired strength press 

- The air strength of "SHOULDER", "ARM", "WAIST", "PELVIS", "BUTTOCKS", "THIGH", "CALF", "ANKLE" can be selected individually.
- Can be reduced with  and increased with 
- Press  and start the massage
- The Footrest does not go down to standby position while using foot air or foot roller.
- Turn the foot air and foot roller 「off」 and lower the footrest when you want to lower the footrest to the standby position.



## How to adjust during massaging

### Adjustment method during air massage

[In the case whole adjustment]

- ① Total Air strength can be reduced with **←** and increased with **→**.

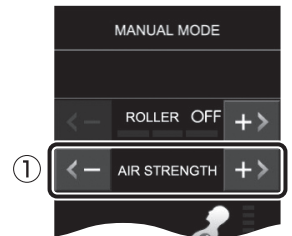

[In the case part by part adjustment]

- ① Press the "AIR"
- ② Select the preferable strength part by part.  
Can be reduced with **←** and increased with **→**.

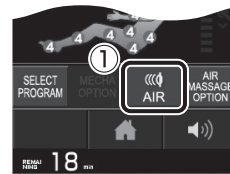

- ③ Return to course screen by pressing **OK**

- Even if **OK** is not pressed, it will be set after 10 seconds approximately.
- There are 7 levels of intensity to choose from. The initial setting level is "4" (the initial setting level of the soft course is "3"). On the first page, "shoulder, arm, waist and pelvis", on the second page, "hip, thigh, calf and ankle" can be adjusted. Press **←** **→** keys to switch the page.
- "OFF" can be set in part wise. If the **←** is pressed when the strength is "1", it will be set to "OFF".

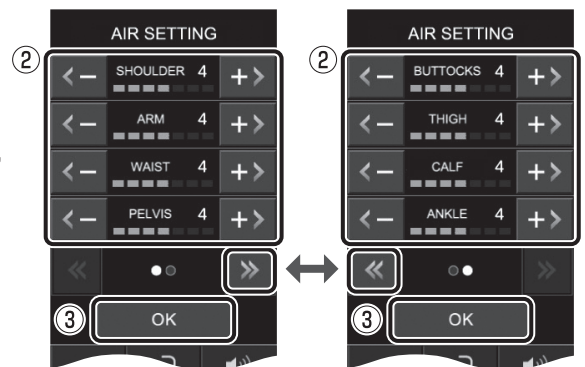

### To set stretch operation

- ① Press "AIR MASSAGE OPTION".
- ② Select "OFF / KNEE / FOOT / DOUBLE".
- ③ Return to course screen by pressing **OK**.

- Even if **OK** is not pressed, it will be set after 10 seconds approximately.
- If the stretch is set to "ON", when leg air in "OFF", leg air will be set to "ON" automatically.
- When the stretch operation is selected, if the foot rest top angle is less, operation will begin after raising stretch operation up to possible angle.
- Multiple stretch operations cannot be set simultaneously.
- Refer to P37, for various stretch operation details

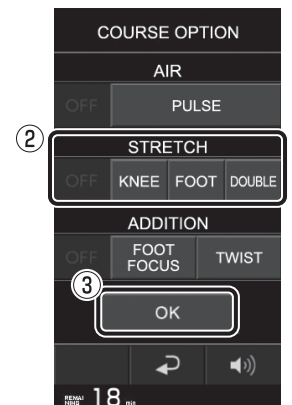
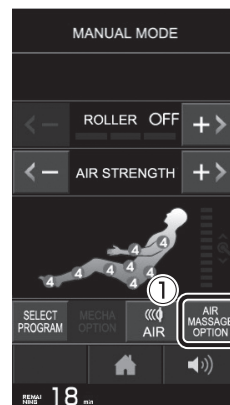

## To set air operation "PULSE" and "HAND KNEAD"

- ① Press "AIR MASSAGE OPTION".
- ② Select "OFF/PULSE/HAND KNEAD"
- ③ Return to course screen by pressing **OK**

- Even if **OK** is not pressed, it will be set after 10 seconds approximately.
- PULSE and HAND KNEAD cannot be used simultaneously.

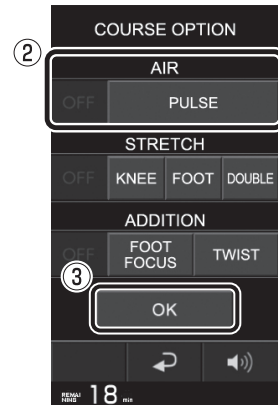
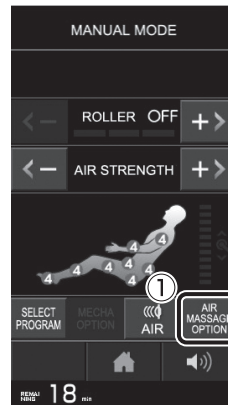

## To set individual operation

- ① Press "AIR MASSAGE OPTION".
- ② Select "OFF/FOOT FOCUS/TWIST".
- ③ Return to course screen by pressing **OK**.

- Even if **OK** is not pressed, it will be set after 10 seconds approximately.
- When the airbags of any part other than the calf and ankle are "ON", "Foot Focus" can be used. When "Foot Focus" is set to "ON", the airbags for calf and ankle will also start.
- When "Twist" is set to "ON", the airbags for waist, pelvis and hip will switch to "ON" and the airbags for thigh will switch to "OFF".
- "FOOT FOCUS" with "TWIST" cannot be set simultaneously.

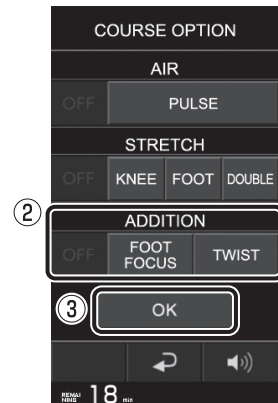
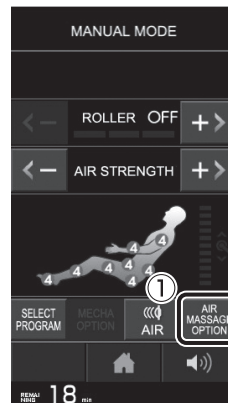

### AIR MASSAGE OPTION

#### [PULSE]

Massage is carried out bit by bit many times by air.

#### [KNEE]

Leg is gripped by air and stretched in forward direction.

#### [FOOT FOCUS]

Calf massage can be done simultaneously with other air massage.

#### [FOOT]

Leg is gripped by air and stretched in downward direction.

#### [TWIST]

Twist operation massage is carried out around the waist center





#### [DOUBLE]

Leg is gripped by air and stretched in downward direction while stretching in forward direction.



# Parts intensive massage

## Start to part intensive massage

1. Switch ON the Power by pressing 

- Regular screen is displayed.
- The seat back is reclined and footrest raises automatically up to the standby position.  
(When reclining angle of   or footrest angle of   or  is pressed, it is stopped)
- If the machine is not operated for more than 3 minutes, then it is switched OFF automatically.

2. Select the preferred part intensive massage by pressing  .

- Moving to other part intensive menu can be done with   .

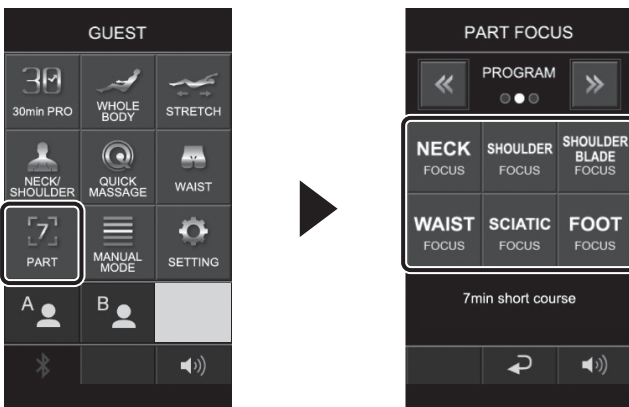
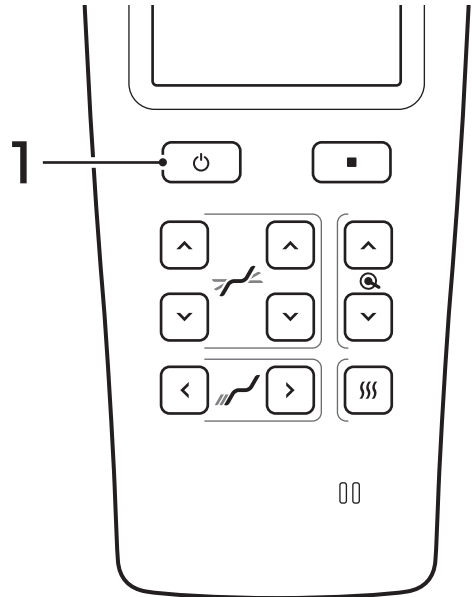

3. Shoulder position detection or waist position adjustment .

- Massage will begin after completion.  
(Some focus kneading techniques don't have shoulder position detection and waist position adjustment.)

[Example] While selecting NECK FOCUS

① Press NECK FOCUS

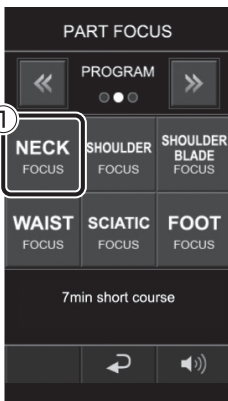

② Shoulder detection has begun.

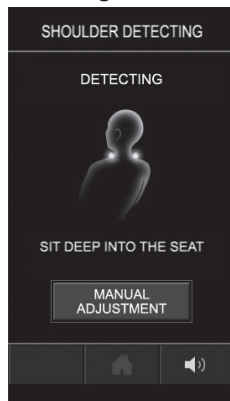

③ Massage has begun.

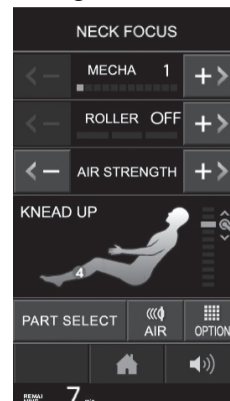



## About operation of part intensive massage

It is a 7 minutes mini course for massaging the part intensively using knead technic.  
The details list that can be adjusted during course of each part intensity

Parts intensity technic		Mecha strength	Air strength	Air Massage		Shoulder Position	Waist position	Combination of foot roller
Short Program	NECK FOCUS	●	●	ON / OFF	Shoulder,Arm,Waist,Pelvis,Buttocks,Thigh,Calf,Ankle	●	-	●
	SHOULDER FOCUS	●	●	ON / OFF	Shoulder,Arm,Waist,Pelvis,Buttocks,Thigh,Calf,Ankle	●	-	●
	SHOULDER BLADE FOCUS	●	●	ON / OFF	Shoulder,Arm,Waist,Pelvis,Buttocks,Thigh,Calf,Ankle	●	-	●
	WAIST FOCUS	●	●	ON / OFF	Shoulder,Arm,Waist,Pelvis,Buttocks,Thigh,Calf,Ankle	-	●	●
	SCIATIC FOCUS	-	●	ON / OFF	Shoulder,Arm,Calf,Ankle (Buttock : ON, intensity not adjustable)	-	-	●
	FOOT FOCUS	-	●	ON	Calf,Ankle	-	-	● (It can not be turned off)
Stretch	NECK STRETCH	-	●	ON	Calf,Ankle	●	-	-
	BACK STRETCH	-	●	ON	Calf,Ankle	●	-	-
	WAIST STRETCH	-	●	ON	Calf,Ankle	-	●	-
	SHOULDER STRETCH	●	●	ON	Shoulder,Buttocks,	●	-	-
	LEG/KNEE STRETCH	-	●	ON	Pelvis,Thigh,Calf,Ankle	-	-	-
	ARCH STRETCHING	-	●	ON	Shoulder,Waist,Buttocks,Thigh,Calf,Ankle	-	-	-
Relax	BACK BODY TRUNK	●	●	ON	Shoulder,Calf,Ankle	●	-	-
	WAIST BODY TRUNK	●	●	ON	Waist,Pelvis,Buttocks,Thigh,Calf,Ankle	●	-	-
	PELVIS CORE STRETCH	-	●	ON	Waist,Pelvis,Buttocks,Thigh,Calf,Ankle	-	-	-

## Adjustment method during massage

### To adjust the strength of mecha massage

① Adjust the back strength by using **+>** for increase and by using **<-** for decrease.

- Strength can be selected from 12 steps.
- The initial setting is set in "1".



### Adjustment method during air massage

[In the case whole adjustment]

① Total Air strength can be reduced with **<-** and increased with **+>**.

- Strength can be selected from 7 steps.
- The initial setting is set in "4".

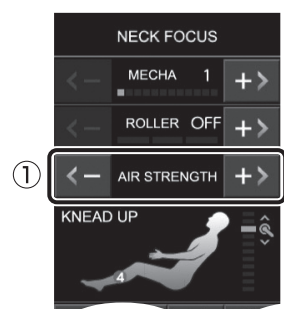

# Combine the rubbing and air massage

## Combine the air massage during rubbing massage operation

1. Press the "AIR".
2. Select the strength of the desired part and press **OK**.
3. Start the air massage of selected part.

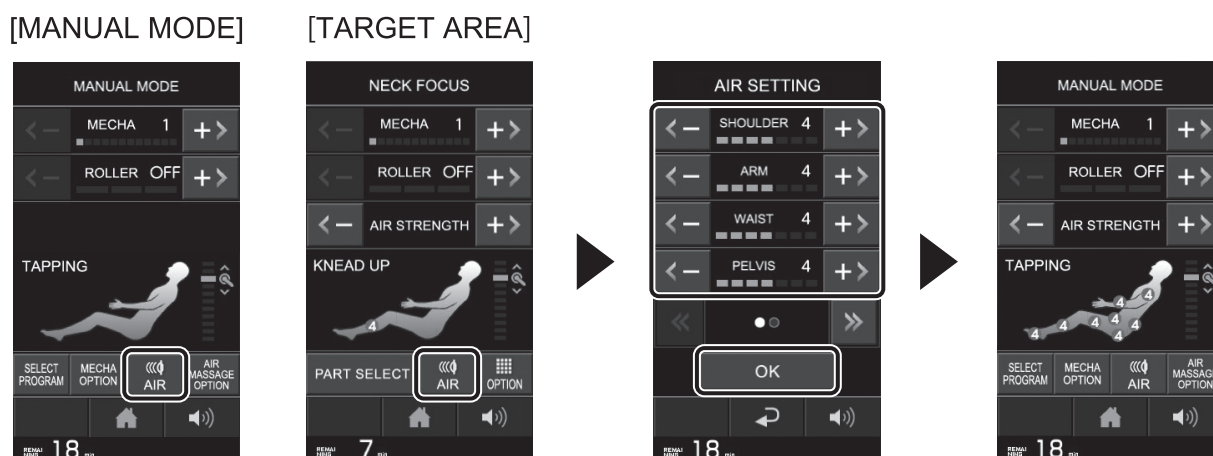

## Combine the rubbing massage during air massage operation

1. Press the "SELECT PROGRAM".
2. Select the desired rubbing massage.
3. Start the selected rubbing massage.

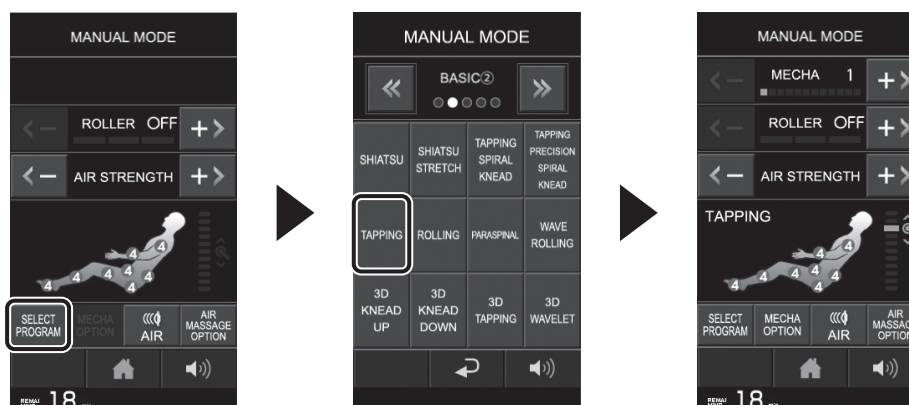

# Foot roller massage

## ! WARNING

Do not hit toes to the foot rollers. Injury may occur.

「Foot roller massage」 can be used with the combination of auto course or manual massage.  
※It can not be used alone.

### 1. Press 「ROLLER ◀ ▶」 while having auto course or manual massage.

- Foot roller strength can be reduced with ◀ and increased with ▶ .
- Strength can be selected from 3 steps.
- “OFF” can be set in part wise. If the ◀ is pressed when the strength is “1”, it will be set to “OFF”.
- When you turn the foot roller massage 「ON」, Foot air turns automatically 「ON」.  
When foot roller massage is 「ON」, foot air can not be turned 「OFF」.
- Depending on the selected course or massage program, foot roller can not be combined or turned OFF. Refer to 「About auto course」(P.27), 「Mecha massage function list table」(P.34), 「About operation of part intensive massage」(P39)

[Display Example]



[When it cannot combine]

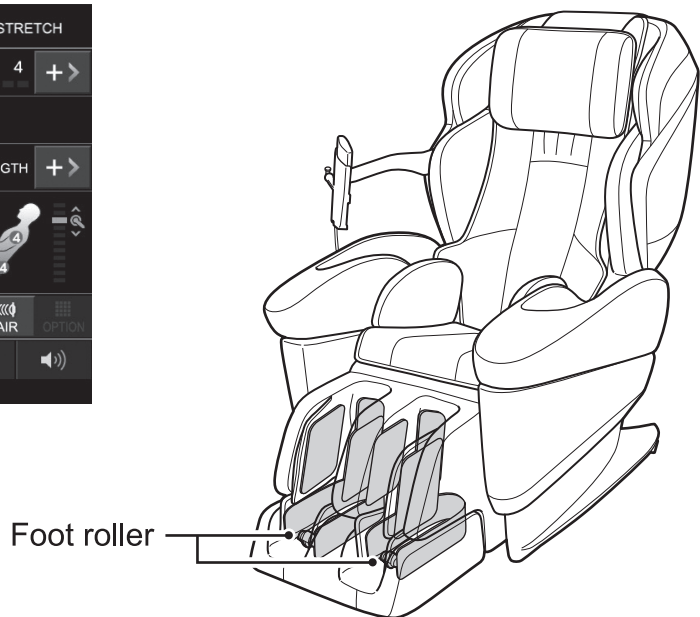

# When changing the Massage in the middle

## Change to auto course

1. or is pressed.
2. Select and press from these Buttons. Press the selected course button and select the desired course.



- There is a chance of muscle line or shoulder position detection. For details, check "Massage by Auto Mode Course".
- Timer for massage operation time is continued.

## Change to part intensive massage

1. or is pressed.
2. Select the preferred part intensive massage by pressing .

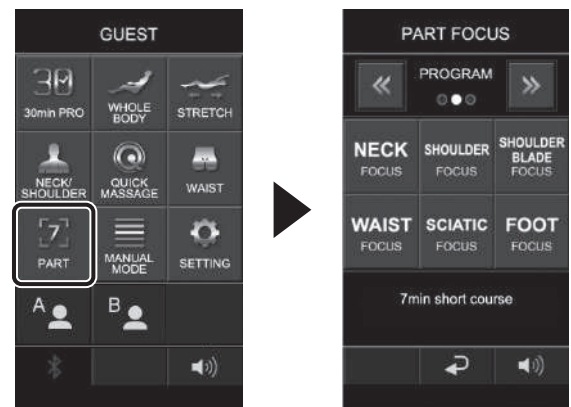

- There is a chance to carry out shoulder position detection or waist position adjustment.
- Timer for massage operation time is continued.

### Timer continuation during course selection

※ It will not be operated in any combination if it exceeds 30 minutes.

- 30 minutes course (start 18 minutes or more) → Normal 18 minutes course

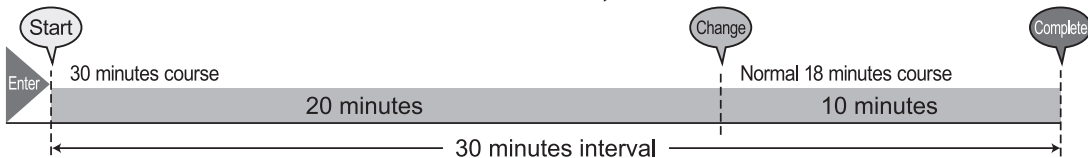

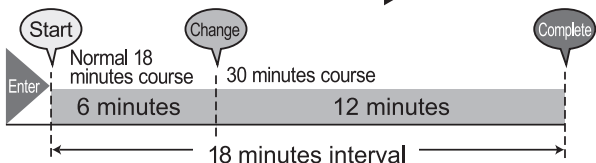

- Normal 18 minutes course → 30 minutes course

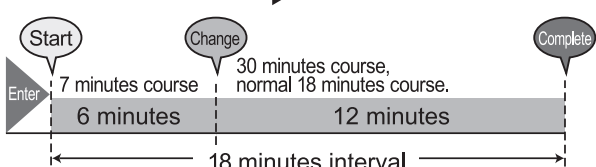

- 7 minutes course → 30 minutes course, normal 18 minutes course





## Change to MANUAL MODE massage

1.  or  is pressed.
2. Press the **MANUAL MODE**, select the desired mecha massage menu and select the mecha massage.

● Timer for massage operation time is continued.



## Change to air massage

1.  or  is pressed.
2. Press **MANUAL MODE**, and press "AIR MESSAGE".
3. Select the preferable pressure and press **OK**.

● Timer for massage operation time is continued.



# QUICK MODE / LANGUAGE / AUTO-RECLINE settings

## About QUICK MODE settings

“QUICK MODE” is the operation mode in which the bold characters are displayed to enhance the visibility and it is with simplified operation

1. Press **SETTING** in the regular screen.
2. If you press QUICK MODE to “ON” and then press **OK**, then QUICK MODE screen will be displayed.
3. If you select the preferred course, then auto course is started.
  - If you press “MODE CANCEL”, then it will move to former regular screen.
  - Even if the power switch off the main unit, QUICK MODE will be continued.



## About AUTO-RECLINE setting

“Auto Reclining” is the function that raises the back rest automatically during power off and massage end and the one that accommodates the foot rest and switches off the power.

1. Press **SETTING** in the regular screen.
2. Press “ON” in the auto reclining and press **OK** in the regular.
  - When press 「AUTO UPRIGHT(POWER OFF)」 while backrest and footrest are stored, auto upright stops. Press again to restart auto upright.
  - When storing, footrest is stored first and backrest is moved up.
  - 「ON/OFF」setting of auto reclining remains even if main power is turned on again.



## About LANGUAGE

You can switch the display language of the remote control. When you change the display language, the language of the voice guidance also changes.

[Switch to other language]

1. Press **SETTING** in the regular screen ,  
each language ( tiếng việt, 繁體字, 简体字, 한국어 ) is selectable.

- Each operation method is similar to English



# About voice guidance

## To adjust the volume of voice guidance

Voice guidance is the function to explain how to operate and brief contents of course and movement.

1. Press "Volume adjustment button  " which is displayed on the lower right of the screen.

- Each time you press the button, it changes as "1" → "2" → "3" → "OFF".
- When you change the language setting, the language of the voice guidance also changes.

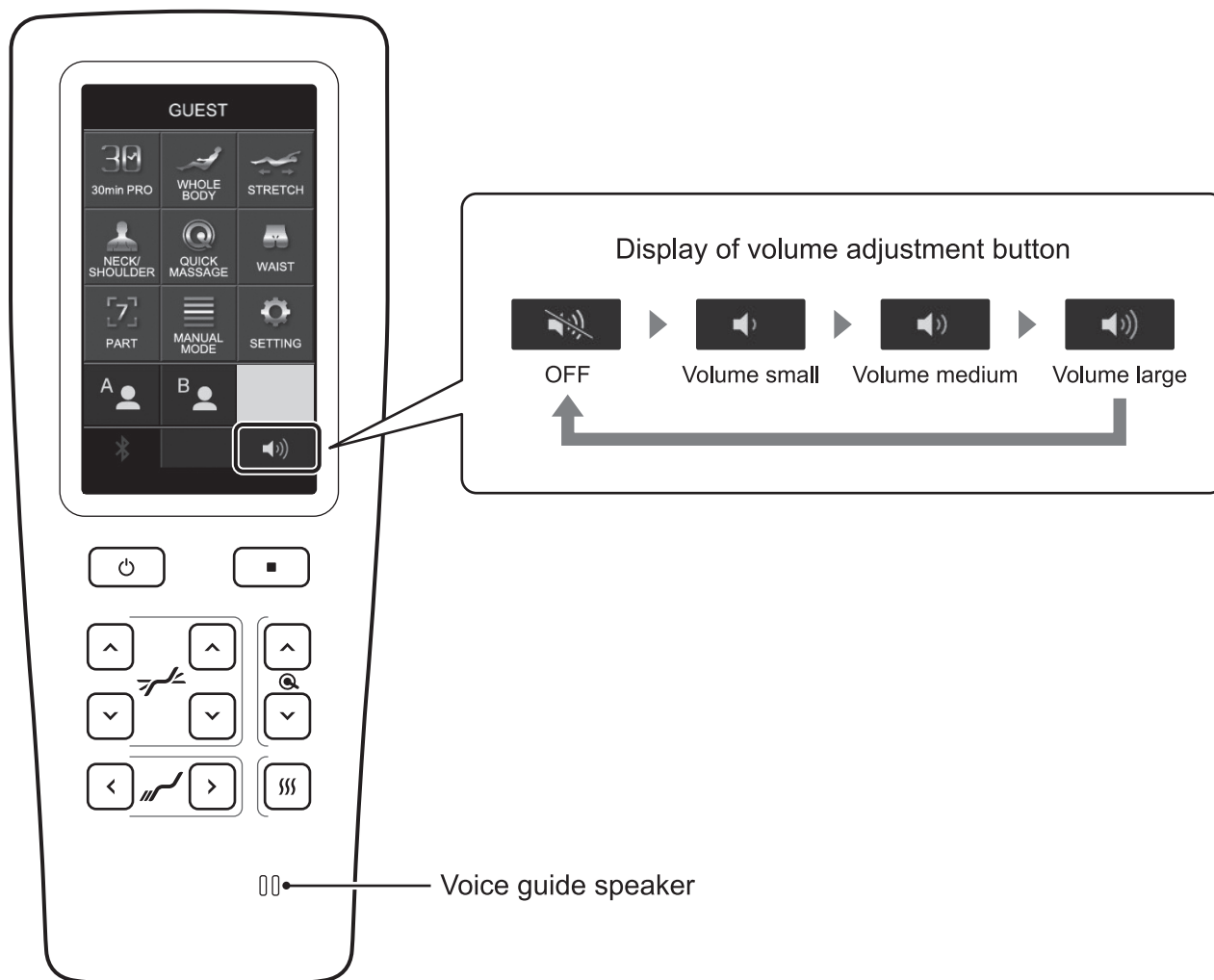



# Heater ON/OFF

## DANGER

Do not use the heater for long time, and do not use the heater in same place for long time.  
It may cause low temperature or injury  
Even at comparatively low temperature (40~60C), and do not use the heater in same place of the skin for long time.  
It may cause low temperature or injury

### 1. Press the heater icon .

- In case the massage and heater are used simultaneously, if the massage is ended, then heater is also ended.
- Heater can be used by itself, by pressing .
- When the heater is used by itself, it will be automatically cut off after about 60 minutes.

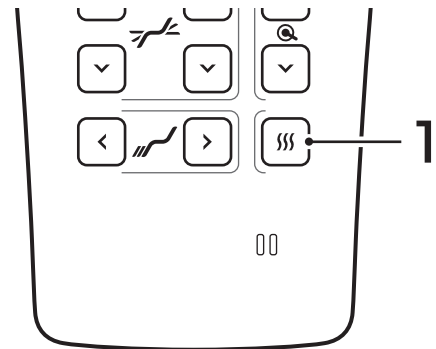

[Display Example]



Heater icon

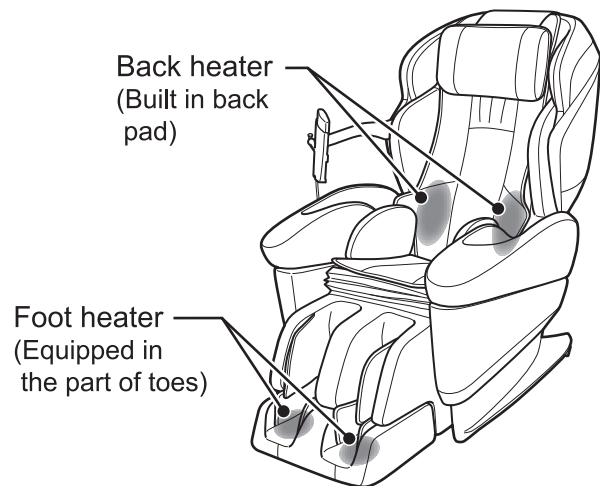

Back heater  
(Built in back  
pad)

Foot heater  
(Equipped in  
the part of toes)

## Position the back pad (heater part)

When warming around  
the waist

Place the back pad on the your  
back.



Back pad

When warming around  
the stomach

Remove the zippers (1) securing the back pad and backrest,  
raise the zippers (2) on the back of the back pad and put the  
heater part in front of your body.

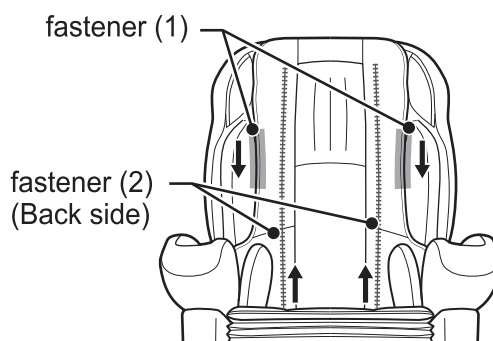

fastener (1)

fastener (2)  
(Back side)



back pad  
(heater part)

# To set the child lock

[Child lock] function disables the button press so that the child cannot operate it by mistake.

1. Press  of reclining and accommodate the backrest and foot rest.

- When child lock is in progress, all the operations are not possible. Accommodate the back rest and foot rest in advance.

2. In the regular screen, if you long press  for 3 seconds approximately, a “Beep” will ring and the child lock screen will be displayed.

- After setting the child lock, if you do not operate within 30 seconds, then the screen will disappear. If you press , then the child lock screen will be displayed.
- When releasing the child lock, either perform the same operation or switch the power of main unit to “OFF”.

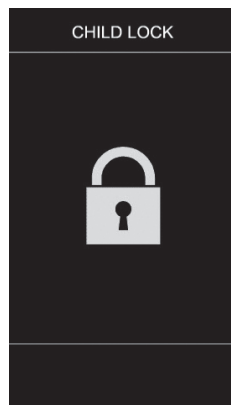
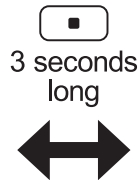
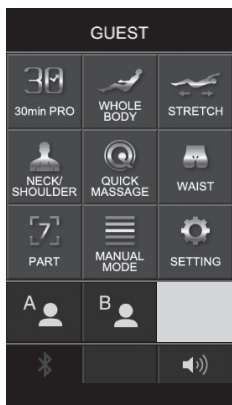
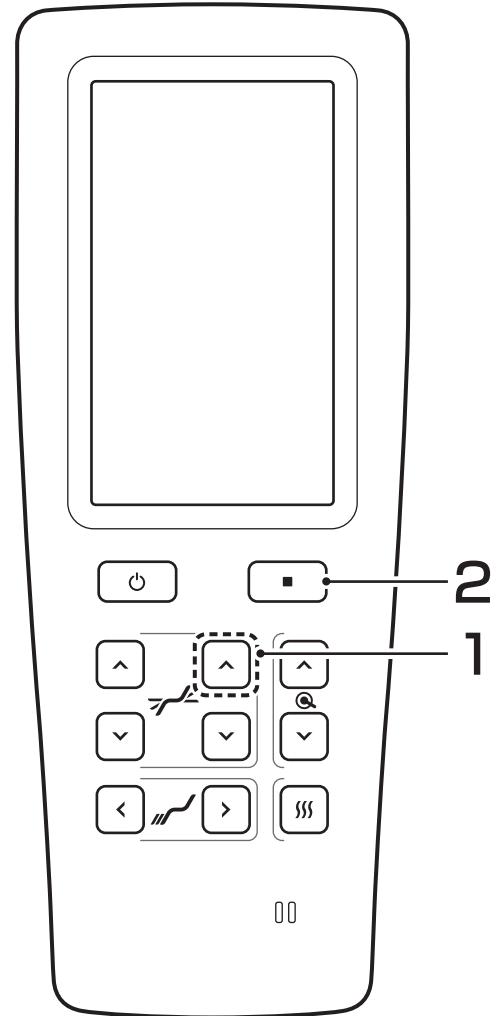

# Usage of BLUETOOTH speaker

---

When the BLUETOOTH is connected, you can listen to music through the BLUETOOTH speakers.

## **WARNING**

Please do not listen at high volume.  
Listening at a high volume for a long time may damage your hearing.

## Precautions for using speakers

- Be sure to read the instructions of the BLUETOOTH device when using it.
- The Company will not be responsible if the stored contents of the connected device disappear.
- When connecting, be sure to reduce the volume of the device in advance.
- If there are electronic devices or transmitters (mobile phones, etc.) around the product, they may interfere with the it. Please keep away from them when using the massage chair.
- If the product is used near the antenna of the TV or radio, the TV or radio may produce noise. Please keep away from them when using the massage chair.





## When connecting for the first time

Pairing must be performed. After pairing is successfully completed, the main body will keep the connection information, and it will connect automatically from the following time. It can store connection information on up to 5 devices.

※ Unable to connect with more than one device at the same time.

### Connect with a smartphone

#### 1. Switch ON the Power by pressing

- Regular screen is displayed.
- The seat back is reclined and footrest raises automatically up to the standby position.  
(When reclining angle of   or footrest angle of   or  is pressed, it is stopped)
- If the machine is not operated for more than 3 minutes, then it is switched OFF automatically.

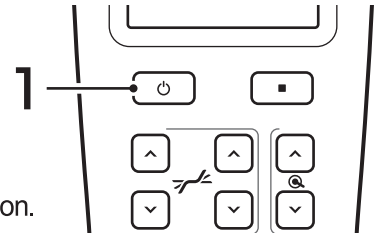

#### 2. Open the BLUETOOTH setting screen by operating the smartphone's setting App, etc.

- For iOS, settings → BLUETOOTH, and for Android settings → Connected device → New pairing device (the name may vary depending on the version).
- After searching, “Massage Chair H22” will be shown in the BLUETOOTH device.
- Push the "search" button when you are near the massage chair.
- Please read the instructions of the smartphone for its operation.





#### 3. When “Massage Chair H22” is shown, click it.

- In iOS, it will be shown at the bottom of the screen, and in Android, it will be shown in the “Available Devices” field. (The name may vary depending on the version.)
- After selecting “Massage Chair H22”, a message such as “Pairing” or “In pairing” is displayed on the screen, and then the device connects (allow pairing in case permission is requested).  
For iOS, the display position of “Massage Chair H22” is moved to the “My Devices” field and for Android the display position of “Massage Chair H22” is moved to the “Connected devices” field.
- After pairing is complete, the BLUETOOTH icon on the remote control will turn blue.
- After pairing is complete, the device will connect automatically from the following time. (up to 5)
- If pairing fails, restart the power of the massage chair main body and try again.
- Since the voice may be output at high volume, please turn down the volume of the speaker device before usage.
- Volume adjustment button  on the screen of the remote control is unable to adjust the volume of BLUETOOTH speaker. Please adjust the volume on the speaker device.
- In case massage, please complete the connection first and then perform the massage operations as usual.
- If used together with massage, the music will also stop playing when the massage is over.
- If used together with the heater, the heater will stop after about 60 minutes, but the music will continue playing.
- If there is no music playing or no operation for 3 minutes during the BLUETOOTH connection, the power will be turned off automatically.

## To connect with other devices (transmitter, etc.)

Explanation of the common connection steps for devices without an operation screen.

### 1. Switch ON the Power by pressing

- Do not place other devices with BLUETOOTH communication function around the massage chair and the device.
- Regular screen is displayed.
- The seat back is reclined and footrest raises automatically up to the standby position.  
(When reclining angle of   or footrest angle of   or  is pressed, it is stopped)
- If the machine is not operated for more than 3 minutes, then it is switched OFF automatically.

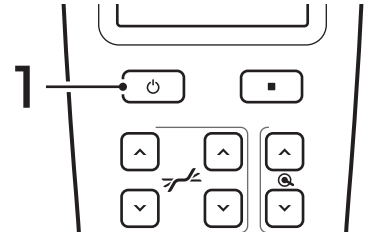

### 2. Operate the device to be connected (transmitter, etc.) and enter the pairing mode.

- The name of pairing mode and operations of switching to pairing mode vary according to the device. Please refer to the instructions of the device for details.
- When the display status of the LED of the device changes, it means that it has entered pairing mode.

### 3. Wait briefly until the connection is successful.

- When the display status of the LED of the device changes, it means that the connection has been completed.
- After pairing is complete, the BLUETOOTH icon on the remote control will turn blue.
- After pairing is complete, the device will connect automatically from the following time. (up to 5)
- If pairing fails, restart the power of the massage chair main body and try again.
- Since the voice may be output at high volume, please turn down the volume of the speaker device before usage.
- Volume adjustment button  on the screen of the remote control is unable to adjust the volume of BLUETOOTH speaker. Please adjust the volume on the speaker device.
- In case massage, please complete the connection first and then perform the massage operations as usual.
- If used together with massage, the music will also stop playing when the massage is over.
- If used together with the heater, the heater will stop after about 60 minutes, but the music will continue playing.
- If there is no music playing or no operation for 3 minutes during the BLUETOOTH connection, the power will be turned off automatically.

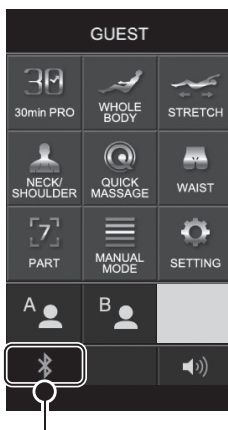

During connection, the BLUETOOTH icon will be blue.

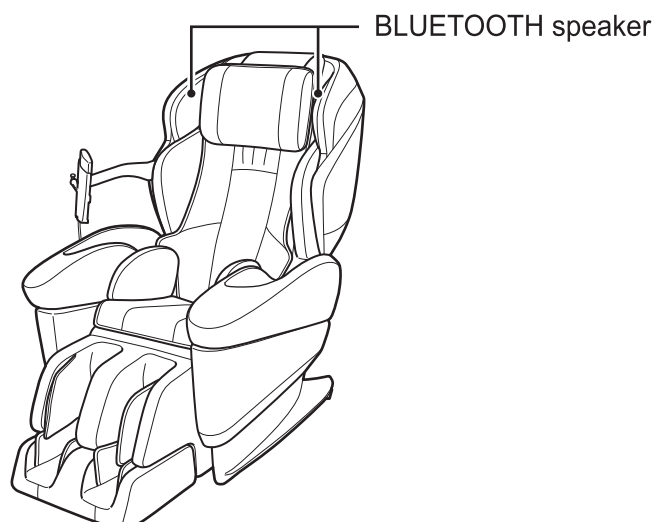

## When connecting from the second time

1. After turning on the power of the smartphone or other device, press  to turn on the power and it will connect automatically.

- The massage chair can keep connection information for up to 5 devices.
- After turning on the power, the massage chair will try to connect according to the order of stored connection information. The connection may take some time (about 30 seconds).
- If connection information of 5 devices are already stored, when connecting with a new device the machine will not connect automatically from the second time, even if the connection is completed according to the steps of “connection for the first time (P52)”. If you want a new device to be connected automatically, please refer to “About resetting pairing information (P54)” to reset the pairing information.

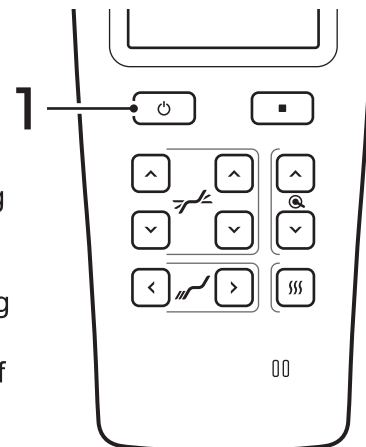

## About resetting pairing information

In the following cases, pairing information must be reset.

- When you do not want the massage chair to automatically connect to the device.
- When you want it to automatically connect with a device after 5 have been already registered.
- When you want to restore the connection to its initial status.

Please note that after resetting pairing information, all previous connection information will be deleted.

1. Press **SETTING** on the course menu selection screen.

2. After pressing BLUETOOTH reset  and “Yes”, the pairing information will be reset.

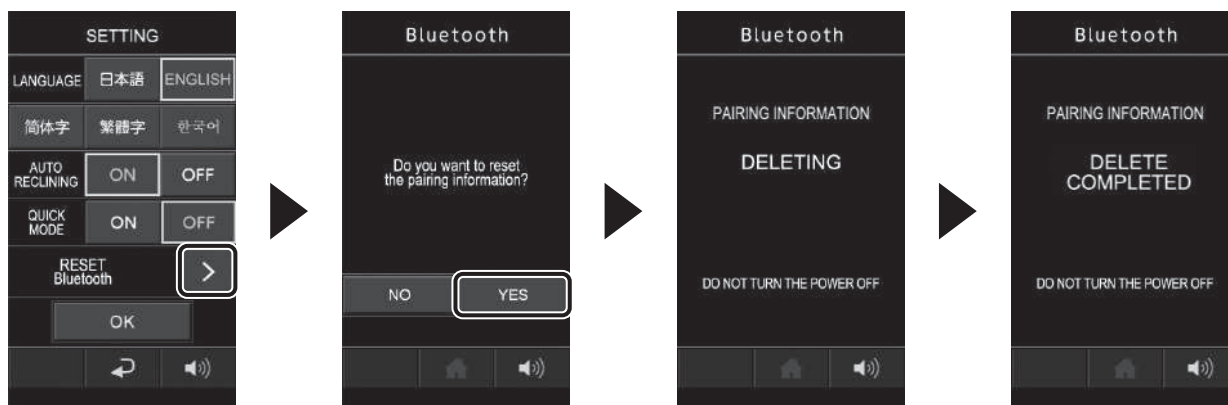

[Note] After resetting the pairing information, the connection information must be deleted also on the connection device. For a smartphone, please find the item of “Massage Chair H22” through the BLUETOOTH setting of the setting App and cancel the pairing or cancel the pairing setting.

[Explanation] Information about the connection between the massage chair and the device will be stored in both the massage chair and the connecting device. Since this information is bound through pairing or pairing setting, when the connection information of one side is lost, that of the other side will also become invalid.

# MEMO

---

# About User Customized Mode

## Functions of User Customized Mode

- It can register / customize information for 2 users.  
Select user A/B and register the customized information. After the customized information is registered, it's possible to skip the body shape detection at the beginning of the course and start the massage immediately.
- The usage of massage and various settings is the same as that in Guest Mode.  
Except for the registration of customized information, other operations are the same as those in Guest Mode. Please refer to the usage of Guest Mode. (P20~54)  
※In the User Customized Mode however, the reset of tap mode, child safety lock and BLUETOOTH pairing information cannot be done. Please do it when in Guest Mode.
- For the function limitations of each mode, please refer to the table on the specification page. (P75)

### Registrable customized information

#### Customize back line

##### Shoulder / waist position information

Shoulder / waist position information  
Select the massage point of the automatic course.

##### S-curve detection information

In order to make the massage chair massage evenly along the back, this function will collect back line information. The detected back line data can also be further edited according to preferences.

#### Customize reclining

##### Reclining information

It is possible to register information of the preferred backrest angle, leg angle / leg length.

#### Customize airbags pressure

##### Air pressure information

After the pre-setting, it is possible to register information of the preferred air massage intensity.

### Customized information first registration example

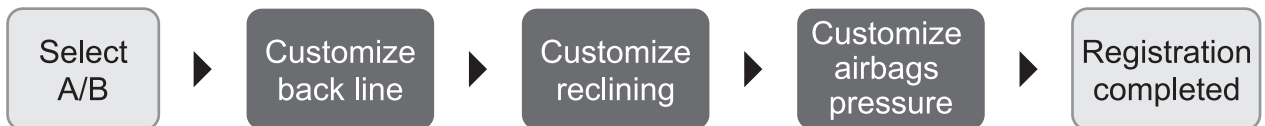

After the reclining information is registered, when selecting the user customized mode A/B, backrest and legs will be automatically adjusted to the registered angle. Please pay attention to the surroundings.

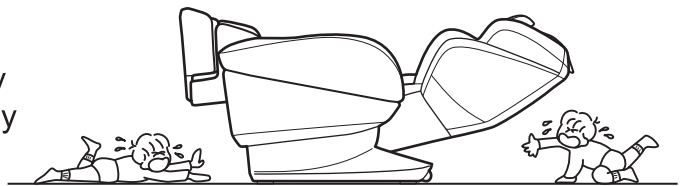



## When using the User Customized Mode for the first time

1. Press  and turn on the power.
2. Select which one you want to be registered from “A/B (①)”.
3. Press “Start (②)” and then start to customize the settings in the order of back line → reclining → air pressure.
4. After the registration of customized information is complete, the screen will return to me

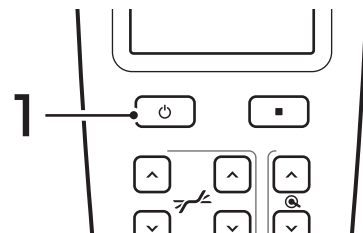

- After the registration of customized information is complete, the User Customized Mode can be used for massage. Operations are the same as those in Guest Mode. (P20~54)
- For various customize methods, please confirm the chapters on “Back Line (P58~59)”, “Reclining (P60)” and “Air pressure (P61)”.
- If the registration of customized back line is not complete, User Customized Mode cannot be used.
- When customizing air pressure, press “Skip” to skip the setting.
- Do not turn off the power during registration, otherwise the registration of customized information cannot be completed.

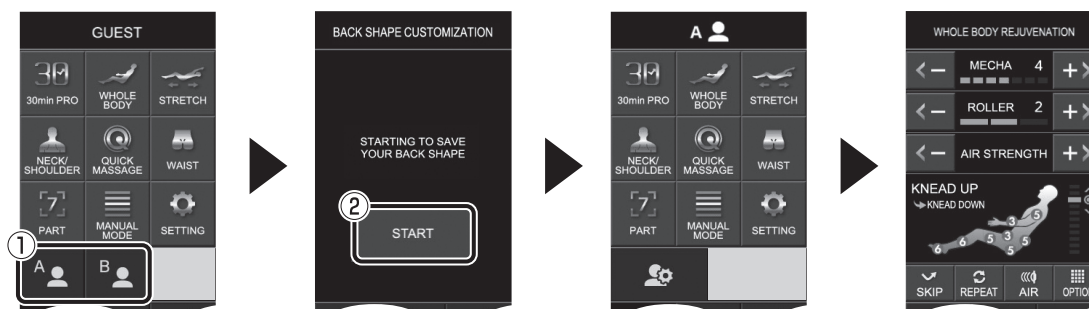

## To reset the user information (re-register)

1. Log in to A or B and press “Settings”.  
After pressing reset user setting , the device will start customizing settings in order of back line → reclining → air pressure.



- When customizing the air pressure, press “Skip” to skip the setting.
- Even if **OK** is not pressed, registration will start after about 10 seconds.
- Do not turn off the power during registration, otherwise the registration of customized information cannot be completed.
- In order to maintain a state where massage can be performed immediately, the back line information will not be deleted. After user information reset, if you cancel before the new setting of customized back line overwrites the old information, the back line information will keep the latest set values.





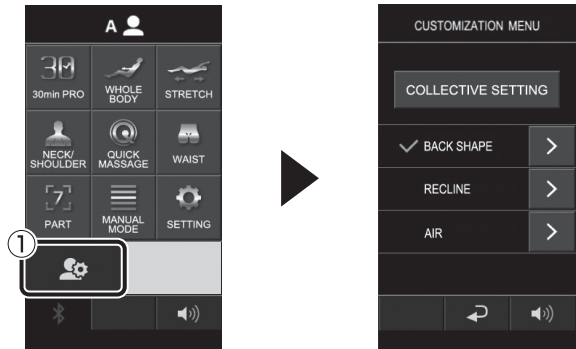

## Customize back line

1. Log in to A or B, and press

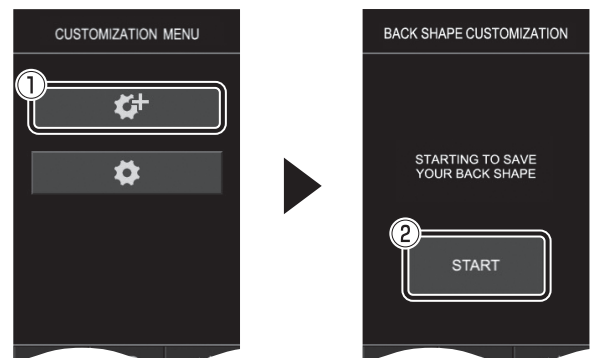
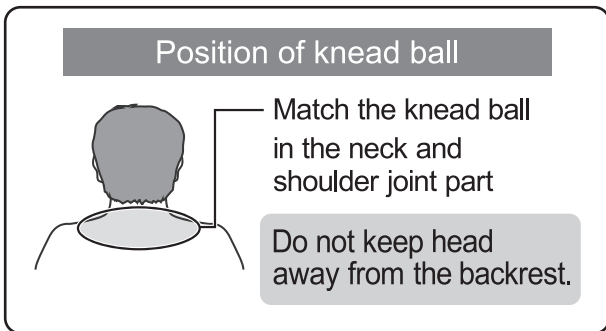

2. Press back line , select  (1) and press "start (2)" to detect the shoulder position. After detection is complete, press **OK** (3), and the shoulder position will be registered. If it is inconsistent with the actual shoulder position, press the "Re-detection (4)" key or the "Manual Adjustment(5)" key to adjust.



- Even if **OK** is not pressed, the massage starts after about 10 seconds.
- Detection starts again when press 「RE-DETECTION」.
- Shoulder position can be adjusted by pressing [MANUAL ADJUSTMENT] during or after the detection. Adjust   (4) for vertical position,   for back and forward position, then press **OK** (6).
- Shoulder position detection measures vertical position. Position can be adjusted through "Manual Adjustment".

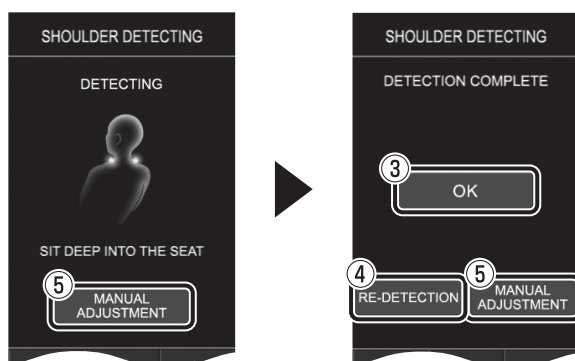

Shoulder position manual adjustment

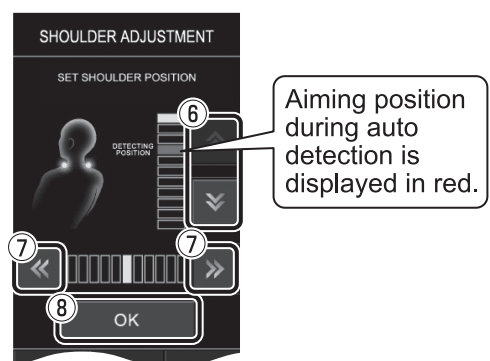

3. After the registration of shoulder position is complete, back line detection will start. After detection is complete, press **OK** (①) and the back line will be registered. Further adjustments can be done through **⚙️** (②).

- Do not keep head away from the backrest.
- Even if **OK** is not pressed, the massage starts after about 10 seconds.
- Press the “Re-detection (③)” key to detect the back line again.
- After pressing **⚙️** (②), the back line can be adjusted manually.
- Please refer to the “About customizing back line” below.
- In case of detection error, press “Re-detection”.

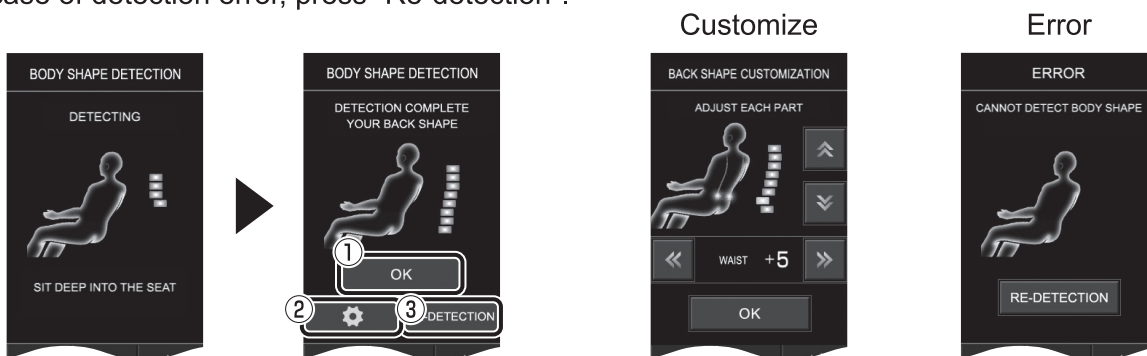

### About back line customization

Generally, massage will be performed with a uniform force along the back line, but the massage standard force of each part can be changed by customizing according to user's preferences.

(For example) To increase intensity for head and shoulder parts

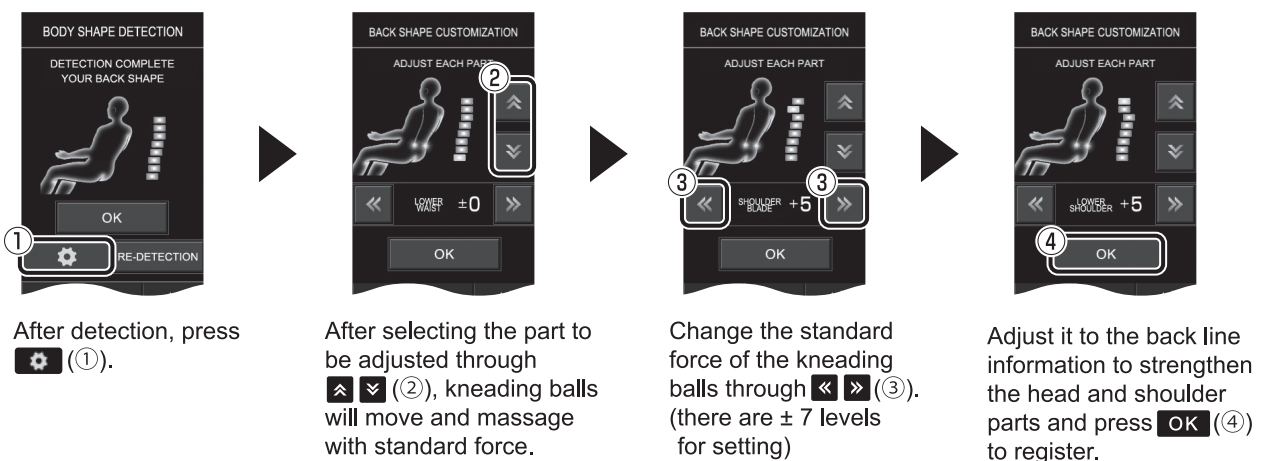

4. After the registration of the back line is complete, waist position adjustment will start. Adjust kneading balls position through **↑ ↓** (⑤) and press **OK** (⑥) to register. If “Registration completed” is displayed, the registration is completed.

- Do not turn off the power during registration, otherwise the registration of customized information cannot be completed.

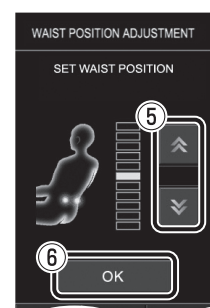

## Customize reclining





1. Log in to A or B, and press



2. After pressing reclining  and  (①), the customize screen will appear.

Adjust the backrest angle, leg angle, leg length and press **OK** (②).

If "Registration completed" is displayed, the registration is completed.

- The backrest angle and leg angle can be adjusted with "Reclining"   (③), and the leg length can be adjusted with "extending"  and "retracting"  (④). Please refer to "Adjusting the angle of reclining and legs" for details. (P20~21)
- The leg angle cannot be lowered below the standby position.
- After registering the customized reclining, backrest and footrest will automatically move to the registered position from the following login.
- Even if **OK** is not pressed, the massage starts after about 10 seconds.
- Do not turn off the power during registration, otherwise the registration of customized information cannot be completed.

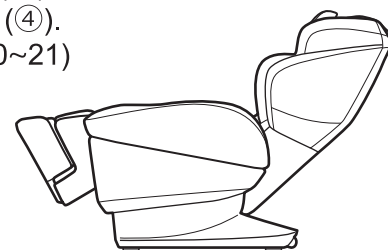

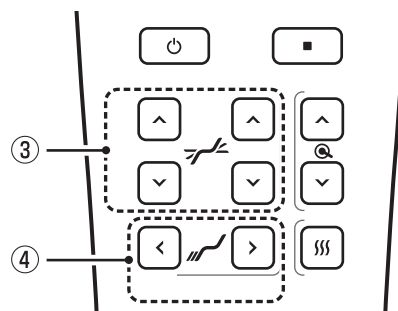
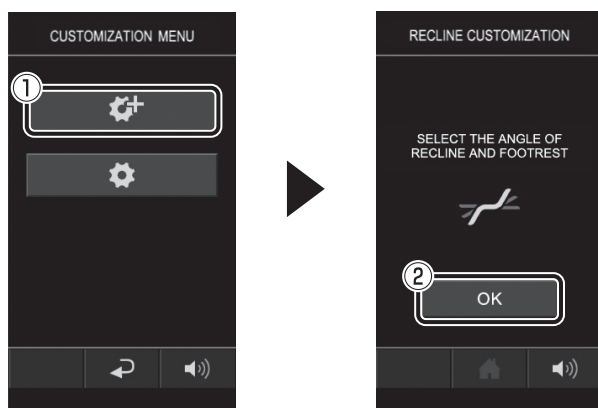

Standby position

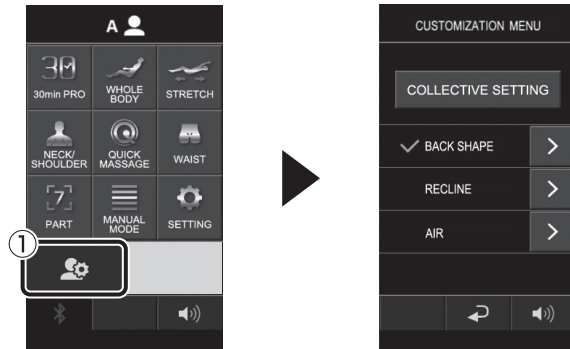

## Customize airbags pressure

1. Log in to A or B, and press





2. Press "Air " , select  (①) and press "Start (②)" to start the setting of intensity for each part. When the air pressure of each part reaches the preferred intensity, press **OK** (③).

(setting order: ankle → calf → arm → thigh → pelvis → hip → waist → shoulder → confirm)

Press **OK** (④) to confirm the intensity displayed on the screen.

If "Registration completed" is displayed, the registration is complete.

- The intensity adjustment action is repeated twice for each part. If "OK" is not pressed, the intensity will be set to "7".
- To adjust the intensity on the confirmation screen, select the number corresponding to the target part and adjust it through   (⑤).
- Do not turn off the power during registration, otherwise the registration of customized information cannot be completed.

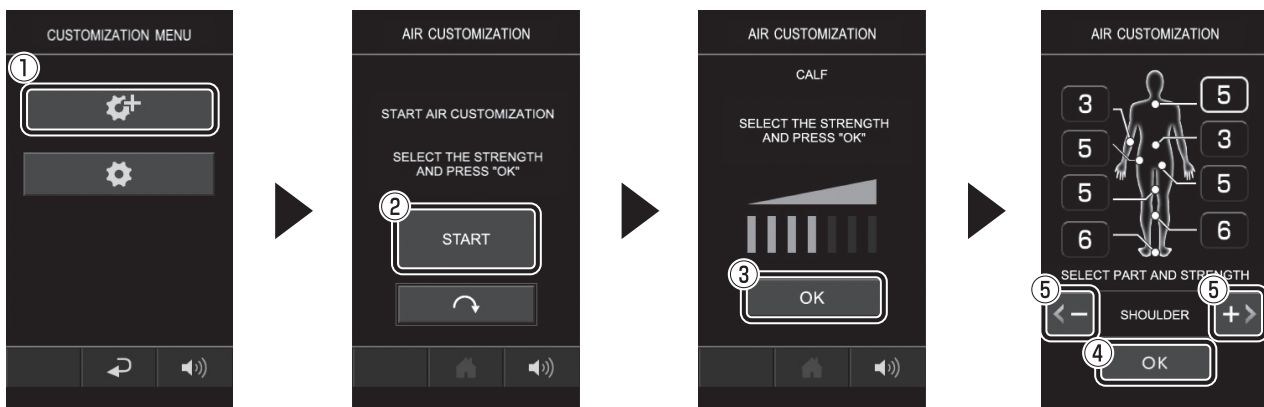

## Batch setting (to reset the batch)

1. Log in to A or B, and press .

After pressing “Batch setting”, setting customization in order of back line → reclining → air pressure will start.

- When customizing the air pressure, press “Skip” to skip the setting.
- Even if **OK** is not pressed, the massage starts after about 10 seconds.
- Do not turn off the power during registration, otherwise the registration of customized information cannot be completed.

## To edit the registered customized information

1. Log in to A or B, and press .

After pressing  to edit the customized information, the edit screen will be displayed.

- For various customization methods, please confirm the chapters on “Back Line (P58~59)”, “Reclining (P60)” and “Air pressure (P61) ”.

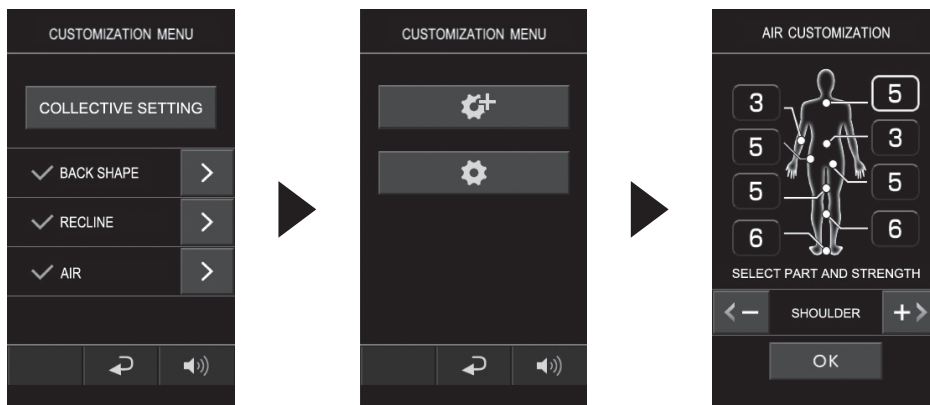

## To switch to other modes

1. To switch from A to B, or from user customized mode (A/B) to Guest Mode, press  and then restart the power.

- When switching to other modes, please restart the power before operation.

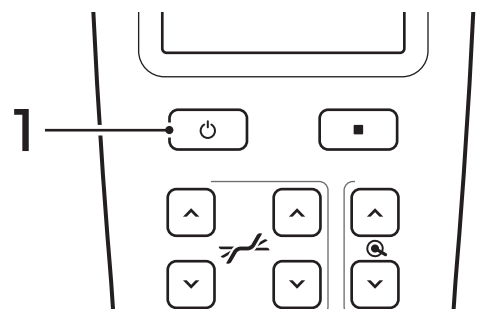

# MEMO

---

# Maintenance and storage

## How to maintain the chair

### **DANGER**

Do not connect or disconnect the power plug by wet hands. Electrification may occur.

### **WARNING**

Make sure to unplug the power plug. Electrification may occur. Do not wipe with benzine, paint thinner or alcohol. This may cause fire or electrification.

## Cloth/Back pad/Pillow

1. Instill water containing neutral detergent and squeeze firmly.
2. Wipe the dirty part with the cloth.
3. Wipe it out with a tight squeezed cloth which is water contained.
4. Dry it naturally after wiping out with a dry cloth.
  - Do not iron. It may damage the fabric.
  - Attention to use the machine with wearing colored clothes as color may adheres to fabrics or cloth.
  - After using the machine with hairdressing on, put something like towel on where your head touches as it may cause the change of color or cracking.

## Resin part

1. Instill water containing neutral detergent and squeeze firmly.
2. Wipe the dirty part with the cloth.
3. Wipe it out with a dry cloth not to leave detergent.
  - Do not use scouring powder. It cause scratches, discoloration, cracks.

## Remote control, lower back(Control box)

Wipe out with a dry cloth.

- Do not wipe out with a wet towel. It may cause malfunction.

## How to storage

### **DANGER**

Do not use or store in the bathrooms or places of high humidity or moisture. Electrification, fire, accidents, and moulding may occur.

Store the chair in the places which is less adverse effect by temperature, humidity, dusts after wiping out the dirt and dusts on the chair.

When the chair won't be used for a long time, put a cover on the chair and avoid the chair from dust.

- Do not store the chair near a stove or the places which chair is exposed direct sunlight for a long time. It may cause discoloration, deterioration.



## How to move the main unit

### **WARNING**

Do not move the chair while people or items are on the chair. Damage or injuries may occur.  
Do not haul the chair itself or move with the casters on the floor where it easily gets scratches.  
Do not pull the power chord or remote control chord with leg or wrap with caster.  
Failure to do so may cause injury.

## When moving with Caster

Float the front side of the main unit, push it and move.

- While lowering the main unit, lower slowly so that the leg part does not get hit.

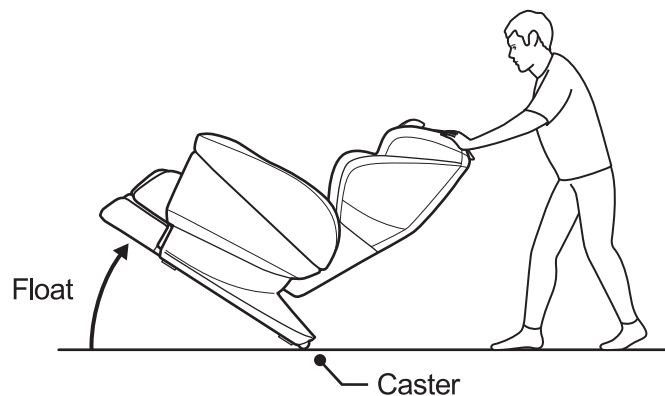

## When more than 2 persons are lifting

Dismantle the arm unit and the arm rest, and after lowering the back rest part, hold the lower part of the front side and back rest with hands (Refer the below diagram) and then lift and move.

- About the method to remove the arm unit, please refer to “To remove the arm unit”. (P14)
- As it is very heavy, select more than 2 persons surely.
- Please watch your steps carefully and lower it slowly.

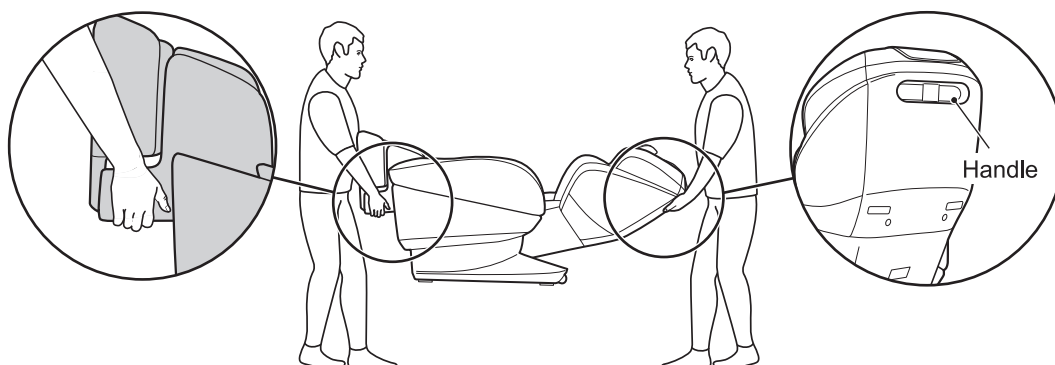

# Q&A

**Q1** Left and right strength is different. And, I feel the difference is remarkable.

**A** To massage for a better feeling, in connection with adopting a mechanism in which the rubbing will mutually hit, unavoidably, the operation might take place in the knead ball slipped position. Thereby, you feel that there is a difference among the left and right strength. But it is not a failure.

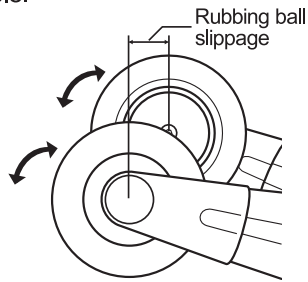

**Q2** The remote control holder is loosened...

**A** Please re-tighten the set screws. If the remote control stand falls off, loosen the set screws first, then re-insert the stand and tighten the set screws again. In addition, check the mounting screws of the stand and re-tighten them if they are loose.

**Q3** Leg is not fitting properly in the leg part...

**A** Adjust by expanding and narrowing the leg part.

- For short people: Raise the back rest part and elevate the leg part.

**Q4** I am commuting to hospital, is it ok to use?

**A** Consult with the doctor in the hospital and then use. "Touch pressure stimulation" refers to the action that promotes the blood circulation for massage by relieving the stress in the muscles. According to the illness, there are risks of getting worse. Hence you should consult with the doctor.

**Q5** Is it possible to use by removing the arm?

**A** No, it is not possible. Air supply and exhaust vent will be exposed, trash and dust will be accumulated and this will be the cause for failure.

**Q6** Is it ok to spread the hot carpet under the chair?

**A** As there is a danger of flame, please stop. Heat generation of hot carpet pains the body and thereby it might generate flame.

**Q7** Can the leg be lowered up to the storing position?

**A** When using foot air or foot roller massage, footrest does not lower to standby position. Turn 「OFF」 foot air or foot roller. (Refer to P37, P43)

**Q8** Won't the backrest or the leg move to standby position automatically?

**A** When the backrest part is lowered below or the leg is raised above the standby position, it will not go back to standby position even if you press  button.

**Q9** Can this be used by people of height below 150 cm or above 185 cm?

**A** Yes, you can use. During sensing, the shoulder position might not match even if you adjust the shoulder position and so proceed using the following methods.

- Short person: Raise the backrest and leg part.
- Tall person: Lower the backrest and leg part.

**Q10** Arm is not reaching the arm unit. What to do?

**A** Raise the backrest and adjust the arm position

**Q11** Will the shoulder and arm become red after shoulder/arm air massage?

**A** After usage, there might be traces of the massage. That's due to the massage. It will disappear in due course of time. And, while doing shoulder air massage, avoid clothes that will expose the shoulders.

**Q12** Even if sensing is done, shoulder position is not matching.

**A** Sit comfortably, lean the face so that it rests in the backrest and after that do the sensing. This can be adjusted manually.

**Q13** During massage, some creaky noises are made. Is it ok?

**A** There is nothing abnormal in the structure. Refer to "Trouble shooting".

**Q14** Is it possible to completely cut off the air massage in the auto course?

**A** It is possible in the course other than 30min PRO course and stretch course. Please refer to "Adjustment method during air massage". And during "WHOLE BODY AIR" in stretch course, if you set the entire air massage to "OFF", then it will be massage end (While stowing) screen and the power will be cut.

**Q15** "Child lock" screen is displayed and remote control is not operable.

**A** Child lock is set. Press and hold "  button" for approximately 3 seconds to unlock the child lock. Refer to "Setting up child lock" for more details.

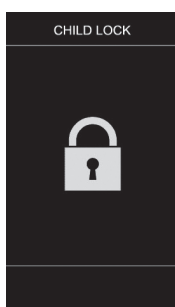

**Q16** If you do a foot stretch, sometimes there is a squeaky noise.

**A** Noise might be generated, but it is not a failure. In the structure, when the electric actuator is isolated from the leg, noise might be generated.

**Q17** It is difficult to feel the differences when change the intensity of foot roller.

**A** It sometimes is difficult to feel the differences of intensity as the intensity of foot roller is adjusted by the strength of pressing by the air of flaps of foot part.

**Q18** The automatic course massage action is different from usual.

**A** Even on the same course, the timing of operation, the number of times of the air bulges the timing of knead ball movement may change depending on strength adjustment, the reclining motion, the pressure to the knead ball.

**Q19** Explain the dimensions of the main unit.

**A** Please refer to the following diagram.

Front view

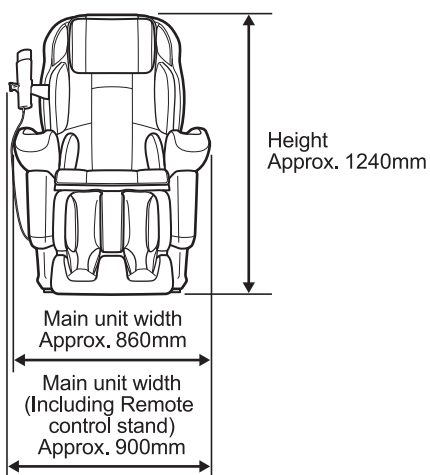

Side view

When it is not reclined

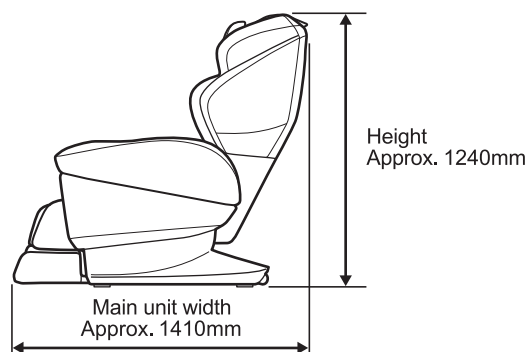

When it is reclined (When the leg part is stretched)

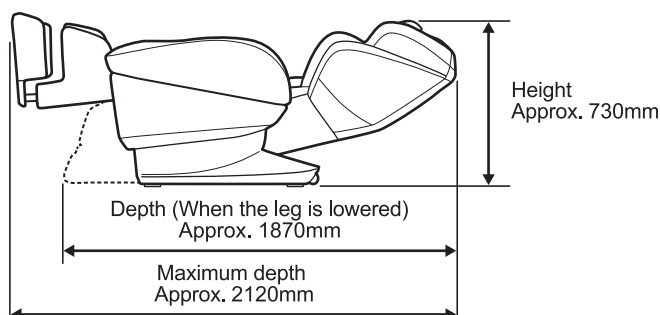

# Trouble shooting

## ! DANGER

Do not remodel and also do not analysis or repair by yourself, there are chances of injury due to fire (or) abnormal operation

You may encounter the following phenomena while in massage. As being due to the mechanical design, they have nothing to do with the product life

- A "clatter" noise occurs when the knead balls go up and down
- A "creak" noise of the gear and the motor occurs while in massage
- A friction noise occurs when the knead balls rub the cover cloth (Particularly while in the process of knead)
- A rattling noise occurs while in the "TAPPING" or "WAVELET" massage.  
(Particularly when the massage moves from the shoulders to the back)
- In the "KNEAD","TAPPING" or "WAVELET" massage, massaging speed may vary with the knead balls strength changed
- A noise becomes different when the massaging speed is changed
- A roaring noise of the motor occurs when load is given to the chair
- A "cuckoo" noise occurs while, in the Auto mode course, the knead balls are automatically adjusted to the back-and-forth position to have the chair fitting in with the user's body shape
- The compressor's noise and the air exhausting noise occur while in air-massage
- A noise occurs when the air bag is inflated
- A screaming noise occurs while in massage of the shoulder
- A grinding noise occurs when the backrest or seat are reclined (Squeak sound)  
(The height of the knead balls between the left and right are different.  
A mechanism is used to allow the two knead balls tapping alternatively. It occurs unavoidably and this is not the trouble)

Symptoms	Check points	Trouble shooting
The chair does not start-up	Is the power plug or the connector on the main unit side missing?	Plug the power plug into the outlet and insert the connector to the inlet.
	Is the power switch of the lower part behind the main body turned off	Turn the power switch "ON"
The chair stops halfway. (The remote controller does not work)	Is the backrest in touch with the main body or the like?	Move the chair away from the main body or the like. Turn the power switch of the lower part behind the main body OFF and ON.
	Is there any load given to the knead balls?(Should there be any load given to the knead balls, a safety mechanism works to stop all the functions)	Detach the body from the backrest for a moment, turn OFF and ON the power switch of the lower part behind the main body and once again operate from the beginning.
The backrest cannot be reclined	Is the power plug or the connector on the main unit side missing?	Plug the power plug into the outlet and insert the connector to the inlet.
	Is the backrest in touch with the wall or the like?	Move the chair away from the main body or the like
The leg part is not lowered to the retracting position?	Is the foot air or foot roller turned 「ON」 ?	Turn 「OFF」 the foot air or foot roller.

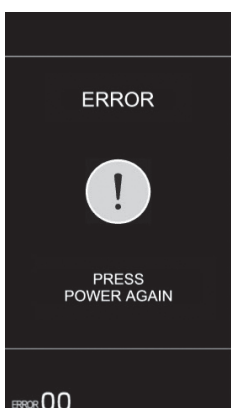

The following message may be displayed on LCD:  
"ERROR: Switch on Power then on/off". In this case, following the instruction, turn the power switch OFF and ON.

- When the operation could not be done normally even if the above counter measure is performed, or the same error occurs repeatedly, switch "OFF" the power switch of main body and disconnect the power cord plug from power receptacle. And then, contact your retailer or our customer care.

## About BLUETOOTH connection

### ■ Unable to pair

- The distance between the massage chair and the BLUETOOTH device should be not more than 1 m.
- Restart the power of the massage chair and try again.
- After resetting pairing information, perform pairing again. (P54)
- Set the specifications of the BLUETOOTH device.  
Please read the instructions of the BLUETOOTH device for the setting method.
- Please confirm the specifications of the BLUETOOTH device. The device must support the BLUETOOTH specification, A2DP and GATT, otherwise cannot be used.

### ■ Unable to connect

- Cannot connect through BLUETOOTH with more than one device at the same time.
  - When the massage chair is already connecting with a device through the BLUETOOTH, it cannot connect with other new devices. Check whether there are other connected devices.
  - The operation of BLUETOOTH devices (smartphone, etc.) varies depending on the device, so please read the instructions of your BLUETOOTH device.
- ※When the BLUETOOTH icon of the remote control is blue, it means that the chair is connecting with a BLUETOOTH of another device. After disconnecting the unused device, please whether the BLUETOOTH icon of the remote control is gray.

### ■ Connection taking a long time / Not automatically connected

- Please connect manually
- ※Smartphones will store connection information of the BLUETOOTH: for iOS go to settings → "My devices" of BLUETOOTH, and for Android go to settings → connected devices → previously connected devices, confirm whether "Massage Chair H22" is displayed and connect (the name may vary depending on the version).
- Please reset pairing information and perform pairing again.
- ※The chair can keep connection information of the BLUETOOTH of up to 5 connected devices.  
It can pair more than 5 devices, but the memory can keep connection information on up to 5 devices only.  
When information on 5 devices has been kept, if you want to keep the information of a new device and allow it to be connected automatically, you must use the pairing information reset function to discard the information that has been kept. (P54)

The operation of the BLUETOOTH (smartphone, etc.) varies depending on the device, so please read the instructions of your BLUETOOTH device.

## About BLUETOOTH connection

### ■ No sound / The sound is too low

- Turn on the power of the massage chair and the remote control. After the course menu selection screen is displayed, turn on the power of the BLUETOOTH device.
- Turn up the volume of the BLUETOOTH device.
- Remove all obstacles between the massage chair and the BLUETOOTH device and shorten the distance between them.
- Switch the voice output of the BLUETOOTH device to the BLUETOOTH connection.

### ■ Sound break / Noise / Sound interruption

- Turn down the volume of the BLUETOOTH device.
- When playing music, if other BLUETOOTH devices are trying to connect or searching, there may be noise and sound interruption.
- Keep microwave oven, wireless LAN and other devices away from the massage chair.
- Keep the TV, radio and devices with built-in tuners away from the massage chair. These devices may affect it.
- Turn off the equalizer setting of the BLUETOOTH device.
- Remove all obstacles between the massage chair and the BLUETOOTH device, and shorten the distance between them.

The operation of the BLUETOOTH (smartphone, etc.) varies depending on the device, so please read the instructions of your BLUETOOTH device.

## Checkpoints

### WARNING

When using the chair after a while, read the user manual once again, check to make sure that it operates normally to use again. Failing which may cause injury or accident.



#### Inspection Important!

Be sure to make inspection for longer use,

Are there these symptoms?

- Chair emits scorching smell
- The power cord or the plug is overheated
- Electricity runs on or off with the power cord moved
- There are some other abnormalities

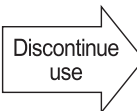

For prevention of accident or trouble, turn "OFF" the power switch of main body, disconnect the power cord plug from power receptacle, and contact your retailer or our customer care.

# MEMO

---

# Specifications

Product name		massage chair	
Model number		JP-3000	
Rating	Power supply (50-60Hz)	AC100-240V	
	Rated time	30 min	
	Power consumption(50-60Hz)	125W (Standby power : 0.3W)	
	Motor power consumption	100W	
	Electric heater power consumption	25W	
Mecha(Knead balls) massage speed adjustment range	Knead	4-step adjustment (approx. 8-30 cycles/min)	
	Tapping	4-step adjustment (approx. 250-650 cycles/min)	
	Up and down	Approx. 1.0-5.4cm/second	
Air pressure for air-massage		Approx. 45kPa	
Mecha(knead balls) massage strength adjustment range	Auto course	7-step adjustment	
	Manual selection	12-step adjustment	
Adjustment range of intensity of foot roller		3-step adjustment	
Rotation speed of foot roller		Approx. 14-21 cycles/minute	
Air massage strength adjustment range		7 levels of adjustment for each part	
Auto-timer		Approx. 7, 18, 30 min	
Reclining angle	Seat back		
	Footrest	When air massage is on	Approx. 56°-84° min
		When air massage is off	Approx. 0°-84° min
Dimensions	Upright position	Approx. W860 x D1410 x H1240 (mm)	
	Reclining position	Approx. W860 x D2120 x H730 (mm)	
Weight		Approx. 96kg	
Upholstery		PVC leather, Polyester	
Country of Origin	Made in Japan		



## Communication specification

Communication mode	comformity with BLUETOOTH standard specification Ver.4.1
Output	BLUETOOTH standard specification Power Class1.5
Maximum communication distance	within 10 m when in good sight
Frequency band used	2.4GHz frequency band (2.402GHz~2.480GHz)
Modulation method	GFSK $\pi/4$ DQPSK 8DPSK
Support BLUETOOTH specification	A2DP 1.3, GATT
Support code	SBC (44.1kHz)
Support content protection	SCMS-T

 **Bluetooth**® The Bluetooth® word mark and logos are registered trademarks owned by Bluetooth SIG, Inc. and any use of such marks by FUJIRYOKI is under license. Other trademarks and trade names are those of their respective owners.

## Functions available in each mode

Function	Guest Mode	User Customized Mode
Customized function	—	○
Reset customized information	—	○
Reset pairing information	○	—
Release course function	—	△ (Execute course only)
Child safety lock function	○	—
Quick mode function	○	—