

Osaki

Instruction Manual

Model No. OS-Pro Soho II

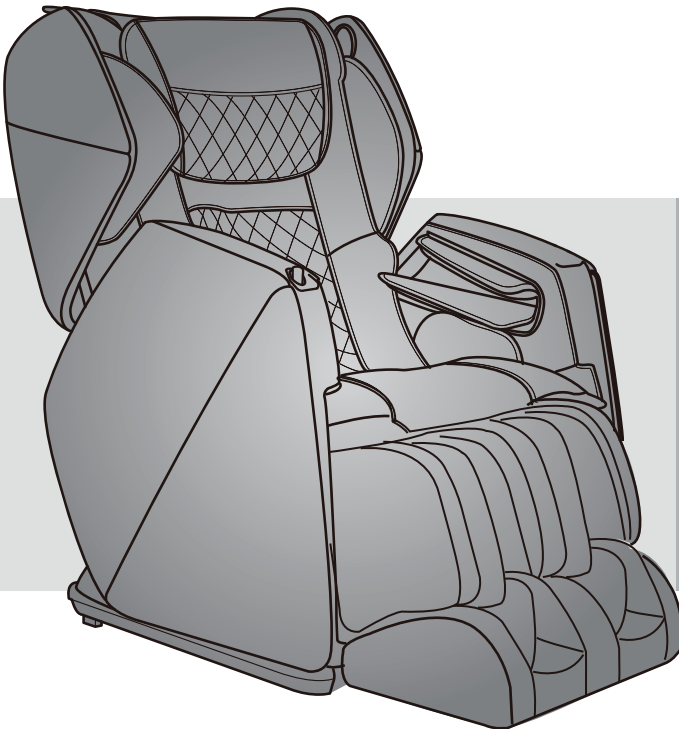

Before operating this unit, please read these instructions completely.

Contents

Before Use

Safety Precautions	1-2
Chair Components	3-5
• Bluetooth Speaker	
Setting up the massage chair	6
Preparation before Use	7-8
Assembly	9

How to Use

Controller	10
How to Use.....	11-15

Q&A / Important

Cleaning and maintenance	16
Troubleshooting	17
Grounding Instructions.....	18
Chair Specifications.....	19

Thank you for purchasing this Massage Chair.
Before using your massage chair, please read the contents of this
instruction manual and refer to it when needed.

Safety Precautions

When using the massage chair, basic precautions should always be followed to reduce the risk of electric shock, burns, fire or injury to persons. Please read the following precautions before using the massage chair.

- Make sure the power plug is securely inserted into a proper electrical outlet to reduce the risk of short-circuit and fire.
- It is highly recommended that a surge protector is used to prevent from damage.
- DO NOT use the massage chair in areas where the humidity is high such as sauna steam rooms, pools, bathrooms, AC or heating vents, etc.
- DO NOT use the massage chair outdoors and avoid areas with direct sunlight.
- If the chair is not being used, turn the power switch to the OFF position and unplug the massage chair from the electrical outlet to prevent any damages to the chair when there are power outages/surges that may cause serious damage.
- Never plug/unplug the power cord plug socket with wet hands.
- Close and continuous supervision is necessary when the massage chair is used by, on or near children or disabled persons.
- No more than one person should use the massage chair at the same time.
- The massage chair is intended for use as described in the Instruction Manual. Do not use any attachments other than those recommended by the manufacturer.
- DO NOT attempt to stand or sit on the backrest, armrest or footrest in order to prevent accident, injury or damage to the chair.
- Avoid falling asleep while using the massage chair.
- Always keep the massage chair clean, and never insert any objects into or around the gaps of the massage chair.
- DO NOT move the massage chair by pulling on the power supply cord.
- Make sure there are no children, pets or other obstacles behind or underneath the massage chair.
- If you find any rips or tears in the fabric of the massage chair, contact the service department and stop using the chair immediately.
- This massage chair is designed for household use and should not be used in non-residential settings.

Safety Precautions

- Please consult your doctor if you are in doubt as to whether or not you should use this massage chair.
- Please consult a doctor before using the massage chair if you are pregnant, undergoing any medical treatment, using a medical electronic device such as a pacemaker, or are experiencing any of the following: malignant tumor, heart disease, back pain, abnormal or curved back bone, osteoporosis or acute illness.
- If you experience pain while using the massage chair, stop using the chair immediately and consult your doctor.
- Never use a massage function on swollen or inflamed parts of the body.
- DO NOT use the massage chair for more than 30 minutes at a time.
- DO NOT use the massage chair where aerosol(spray) products are being used or where oxygen is being administered.
- This massage chair is a non-professional product designed to provide a comfortable massage and should not be substituted for appropriate medical treatment.
- Never operate the appliance with the air hoses that inflate while they are blocked. Keep the air openings free of lint, hair, and any other obstructions.
- Check the skin which is in contact with the heated area of the appliance frequently to reduce the risk of injury. If the heating pad malfunctions and extreme heat is produced it may cause serious burns.
- Burns may result from improper use. If this is the case immediately shut off the chair and unplug from the outlet.
- Remove all sharp objects from the body and pockets such as keys and pens.
- Keep children away from extended foot support (or other similar parts.)
- DO NOT WET-DO NOT USE PINS.
- NEVER REMOVE COVER.



Caution

The user's weight is usually limited to 220 lbs.

For those who are weighing 220 lbs or more, the product operations may make more noise and the fabric cover may wear out faster.

Chair Components

Front

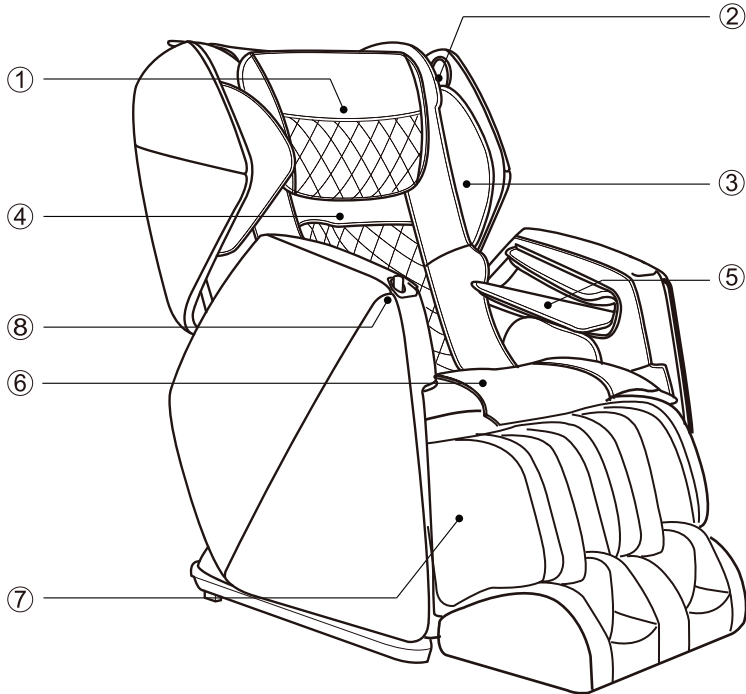

① Pillow Pad

③ Shoulder side massage section

⑤ Hand and arm massage section

⑦ Legrest

② Bluetooth Speaker (See Page 5)

④ Backrest Pad

⑥ Seat

⑧ Controller Storage Compartment

Chair Components

Bluetooth Speaker

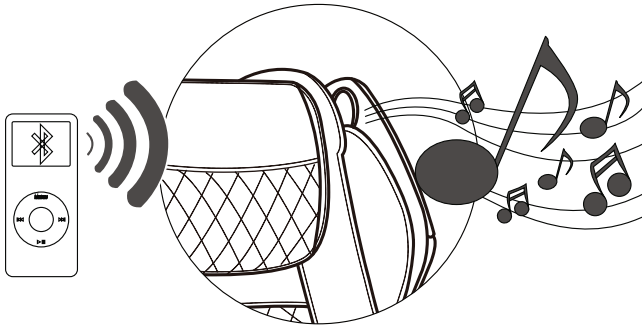

NOTE:

The bluetooth speaker can only connects with one bluetooth device at a time. Please turn off your bluetooth device after using so that other users can enjoy it as well.

Chair Components

Air Massage Area

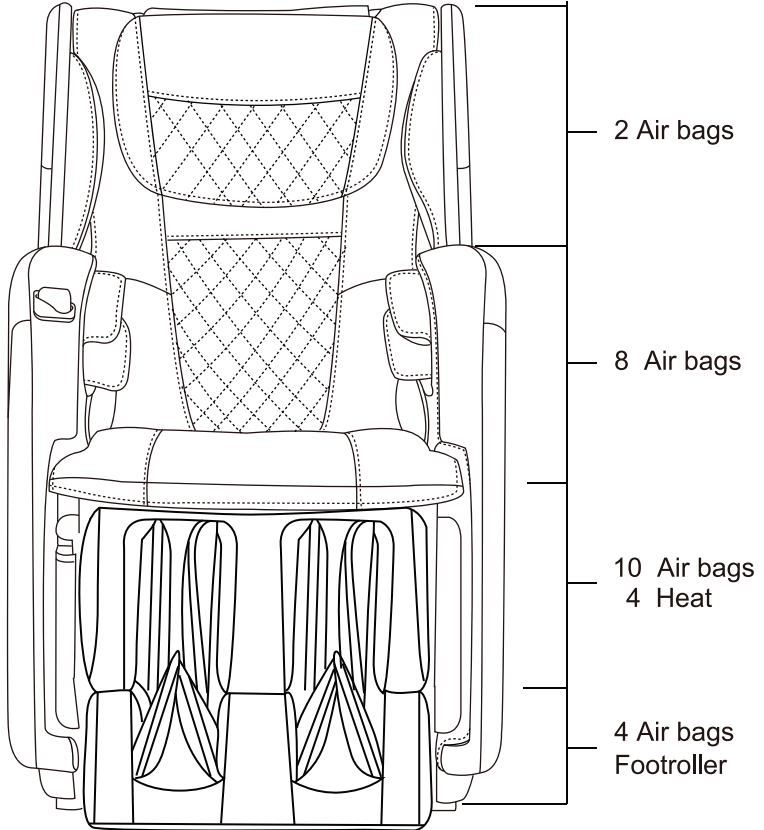

Setting up the massage chair

1. Installation Position.

- Ensure there is adequate space to recline.

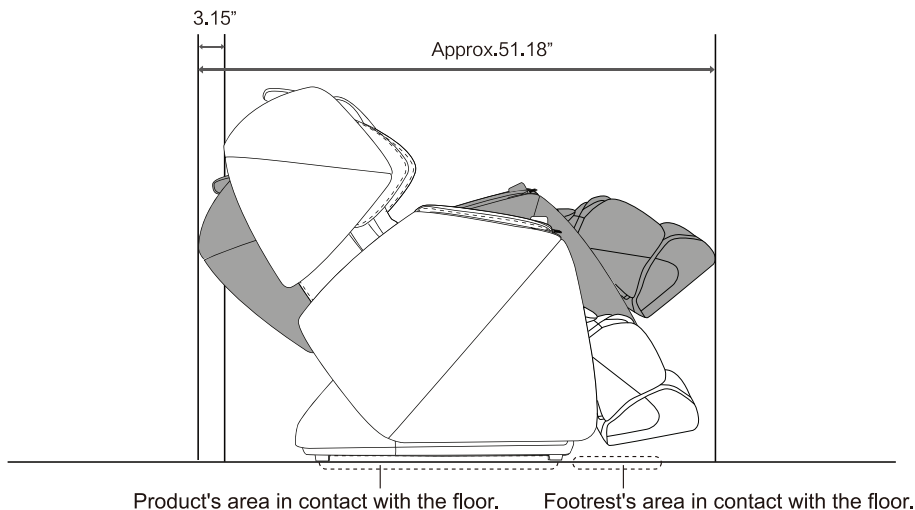

- Do not expose the massage lounger to direct sunlight or high temperatures, such as in front of heating sources, because this can cause discoloration or hardening of the synthetic leather.
- Place the unit on a mat to prevent floor damage.
- When placing a mat under the unit, the size of the mat should be sufficient (at least 71" x 35") to cover the areas where the unit touches and where the legrest could touch the floor, as shown in the diagram on the above.
- Install the unit near a power outlet.

Preparation before Use

1. Check the space around the product.

Make sure there is no person, pet, or other object close to the product.

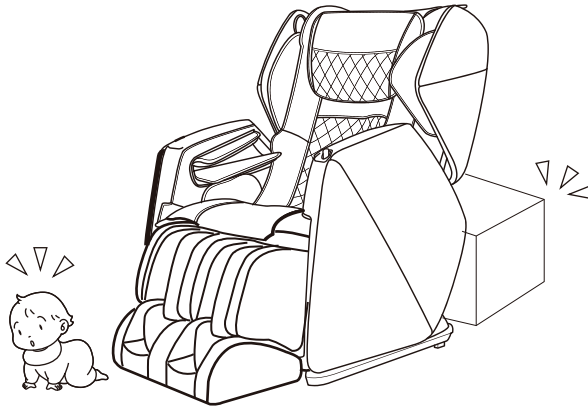

2. Make sure there is no foreign matter in the seams of the product.

- Before sitting on the product, make sure there is no foreign matter between any two parts of it.
- Do not put hands, arms or head between the backrest and the back cover.
- Do not put pets on the product (such as its back cover, backrest and armrests).

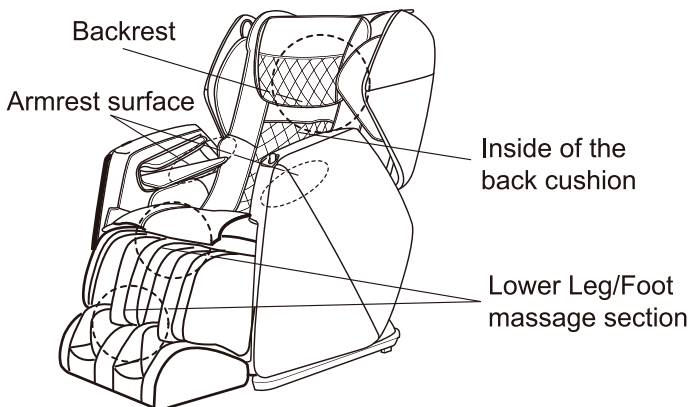

Preparation before Use

3. Power on the product

- ① Push the power connector into the appliance inlet till the end.
- ② Insert the power plug into the power outlet till the end.
- ③ Turn the switch to "I" position

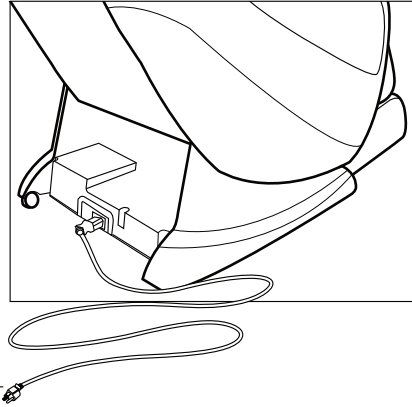
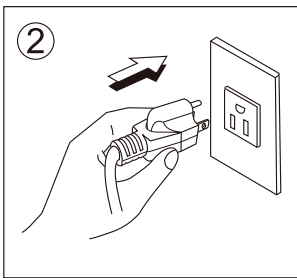
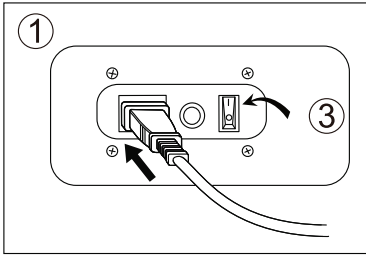

4. Make sure the massage rollers are retracted.

If they are not, press ON button to return them to the retracting position.

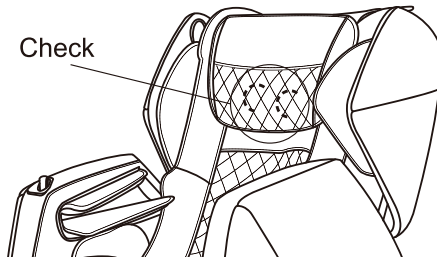

Assembly

- ① Connect all the air hoses and wires (E1 to E2, F1 to F2, G1 to G2)
- ② Align the holes H1 and shaft H2, let H2 pass through H1
- ③ Lock the shafts with the circlips provided.

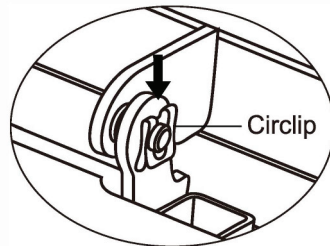
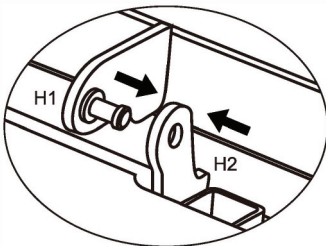
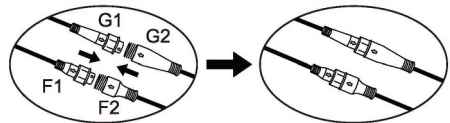
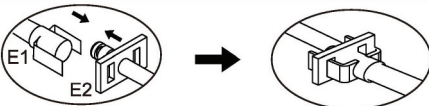
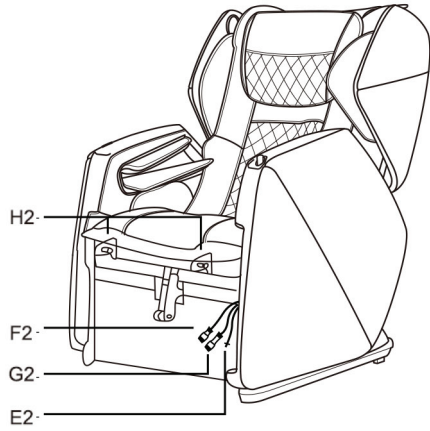
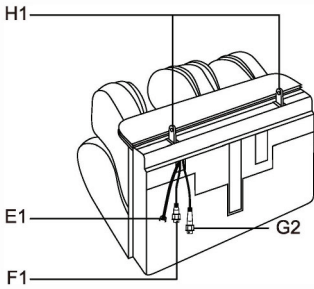

How to Use

Controller

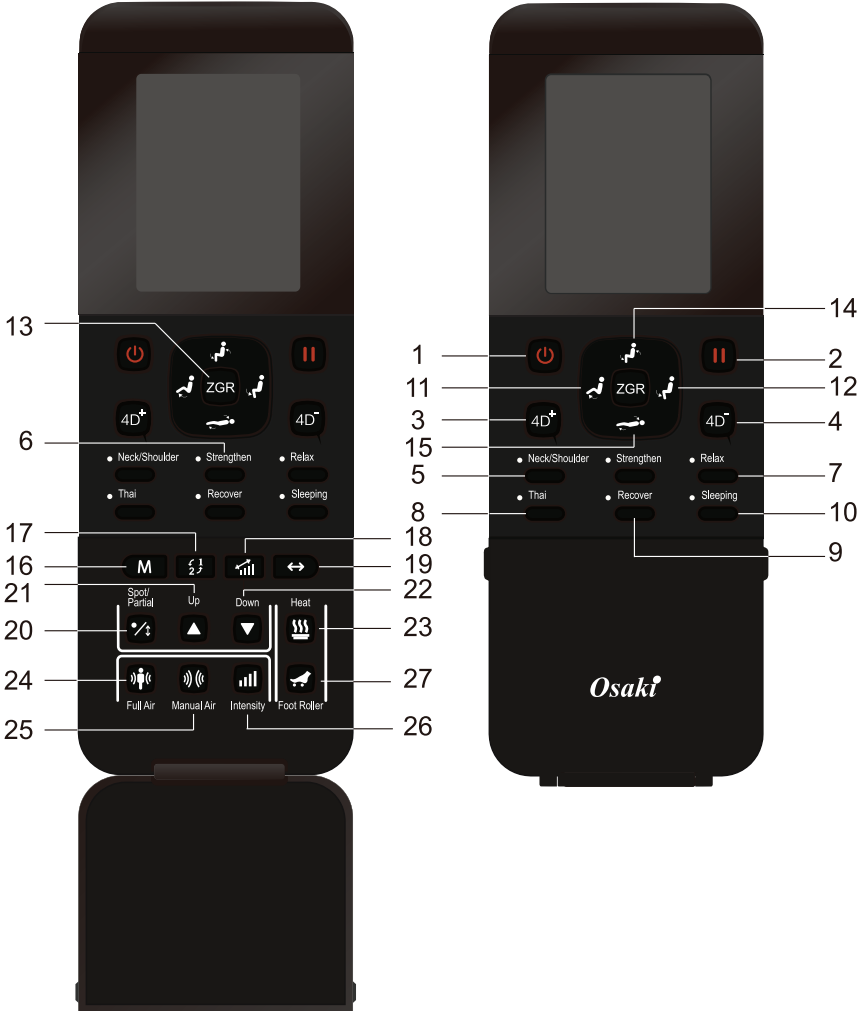

How to Use

Product Operation Guide

Connect to the power supply, then turn the switch to "I" position, thus the chair will be in idle mode, and the backrest angle will reach the highest position as well as the footrest angle will reach the lowest position. During its idle mode, there are only five functions: ON/OFF, Incline, Recline, Incline Leg, Recline Leg that can be operated.

Control Buttons for the Massage Chair

1. ON/OFF

The Start/Stop Control Button

Press once on this button, the LCD backlight and ON/OFF button will be lit. Press any massage function button to start the chair's massage functions. This will also start the timer function. Press this button again to stop all massage functions, and the massage rollers & backrest & leg-rest will return to their position.

2. Pause

The Pause Button

When the chair is in massage mode and the user wants to temporarily pause it, press the Pause Button and all massage functions will stop. The "Pause" button will be blinking and the set time countdown will be paused as well. Press the Pause button again to resume the original massage function, the set time countdown will continue.

3/4. The 4D Adjustment

Press the Left/Right to adjust the 4D massage roller forward/backward respectively.

There are 5 different levels available for adjustments to suit various massage strength requirements.

How to Use

Auto program

If either 1 of the 6 auto program is activated, chair will automatically performing a shoulder height scan. And the theme will go to shoulder adjustment automatically, user can manually adjust the shoulder height position to the desired comfortable position before auto program start.

The following are the auto program available:

5. Neck/Shoulder

6. Strengthen

7. Relax

8. Thai

9. Recover

10. Sleeping

11/12. Incline Leg / recline Leg

Angle Adjustment Control Button for Footrest

These two control buttons can adjust the massage angle on the footrest .

Press once on the Incline Leg or Recline Leg control button, and the Footrest will start to move;

When the Footrest reaches the desired comfortable position, press the button again to stop it.

13. Zero-G

Press this button to activate Zero-G1 function in default, press the button again to activate Zero-G2 function, and press again to return to the idle position.

Note: If this button is pressed while moving to Zero-G1, the massage chair will stop at the latest angle. If Zero-G button is not pressed while moving to Zero-G1, the massage will stop at the preset Zero-G1 angle. Same conditions apply to Zero-G2 function.

How to Use

14/15. Backrest Incline / Recline

Angle Adjustment Control Button for Massage Chair

These two control buttons can adjust the Backrest Inclining/Reclining angle respectively.

Press once on the Inclining or Reclining control button, and the Backrest will start to move. When the Backrest reaches the desired comfortable position, press the button again to stop it.

16. Manual Massage Function

KNEADING, TAPPING, SWEDISH, SHIATSU, CLAPPING, ROLLING

Press this button to activate the rhythmic kneading manual massage function for a full back massage at medium strength. Every time this button is pressed, the manual massage function will change in the sequence of KNEADING> TAPPING>SWEDISH>SHIATSU> CLAPPING> ROLLING>Stop.

17. Direction of Manual Massage Function

When the manual massage function is operating, press this button to change the rhythmic mode of manual massage between 1 and 2.

18. Speed

The Speed Adjustment Button for backrest -5 levels of speed can be adjusted. After activating manual massage function, every time the button is pressed, the speed can be adjusted to from weak to strong.

19. Width Adjustment

Back massage width adjustment button- 3 level available

After activating the tapping, clapping, shiatsu or rolling function, user can touch the button to adjust massage width, total 3 level available (narrow, medium, wide).

How to Use

20. Spot / Partial

The Spot or Partial Back massage

This button allows the user to select spot massage for any part on the back.

Press this button once to activate spot massage at the required location.

Press this again to switch to partial function.

The Partial Back massage

While running spot massage, when this button is pressed again, the massage will change from spot to partial. the massage will take the spot position as the centre to perform partial massage at a distance of approximate 8 cm. Press again to the stop the function.

21/22. Upward / Downward

The massage position adjustment button for spot and partial massage

When the manual or automatic shoulder scanning can't meet individual requirements, you manual fine tune the shoulder height location by pressing up /down button within sound 10 seconds. Once appropriate location found release the key, the final position will be lock.

Note: In the spot or partial massage, you can also use these two buttons to adjust the massage position.

23. Heat

Every time this button is pressed, the heat massage function will change in the sequence of mechanism heating > knee/leg heating > mechanism /knee/leg heating > stop.

24. Full Body Air Pressure Massage

Full Body Air Pressure massage

Press once to activate the air-pressure massage at full body Press again to stop the function.

How to Use

25. Manual Air

Setting Air Squeeze

Every time this button is pressed, the manual air-pressure massage function will change in the sequence of LEGREST>ARMREST>SHOULDER>STOP.

26. Intensity

The Intensity Adjustment Button for Air-pressure- 5 levels of intensity to be adjusted.

After activating the air-pressure function(Auto and Manual), press this button to adjust the intensity in the cycle.

27. Foot Roll

Foot roll function Start/Stop Control Button

Press once to activate the roller on foot, press again to stop the foot roll function.

End Operation

Please press the "ON/OFF"button after use, and the chair will stop its operation, while the massage rollers will return to their original position; then switch the power supply button under the chair to "O"position and unplug the machine from the electrical outlet.

Cleaning and maintenance

1. Cleaning of the synthetic leather

Wipe the synthetic leather with a soft dry cloth.

- Do not clean the product with chemicals such as thinners, gasoline and alcohol.
- When using a leather maintenance product (cleaning cloth) sold on the market, follow its directions for use.
- If the synthetic leather is very dirty, wipe it with the method below.

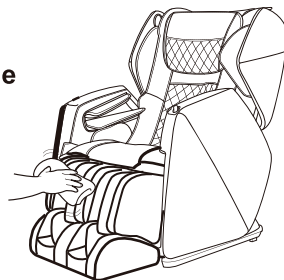
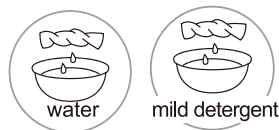

- ① Put a piece of soft cloth into water or 3% to 5% neutral detergent contained hot water and wring it out.
 - ② Wipe surface of the synthetic leather with the soft cloth.
 - ③ Wipe the detergent with a piece of cloth once soaked in clean water and wrung out.
 - ④ Wipe with a piece of wrung soft cloth.
 - ⑤ Have the synthetic leather take natural air drying.
- If it is difficult to remove the stains on the synthetic leather, soak a piece of melamine foam bought from the market into a neutral detergent and use it wipe the product.
 - Do not dry the surface by a hair drier.
 - Surface of the synthetic leather may be dyed by fabric colors; therefore, be careful when wiping the product with denim or colored cloth.
 - Synthetic leather may discolor, so the position in contact with the hair dye used should be covered by a towel.



2. Cleaning of the plastic parts

- 1) Put a piece of soft cloth into water or neutral detergent contained hot water, wring it out and wipe the plastic parts.
- 2) Wipe with a piece of cloth once soaked in clean water and wrung out.
- 3) Have the plastic parts take natural air drying.

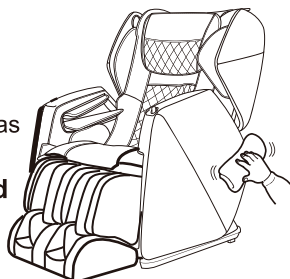

Troubleshooting

This page summarizes the most common problems you could encounter with the product. If you are unable to solve the problem with the information below, contact service center immediately.

If the problem encountered is not listed, please try the following suggestions:

1. Turn off the product and unplug it.
2. Wait for 60 minutes.
3. Plug the product back to the recommended outlet and restart.
4. If the problem persists, contact the authorized service center.

Problem	Possible Cause	Suggestion
The product does not work	The product is not plugged in properly.	Ensure the voltage on the product corresponds to the local mains voltage and then plug in again. Make sure the outlet is properly working.
The product stopped working	The product has just finished its auto timer session and has automatically switched to standby mode.	If you want another session, press the Power button again.
The product stopped working	You may have used the product continuously for 45 minutes where the over heat protection has been activated.	Unplug the product and let it cool down for 60 minutes before you use it again.
The product does not work	An excessive load has been applied on the product.	Reduce the excessive load and start again.
The product is abnormally warm	The product is likely to be overused.	Unplug the product and let it cool down before using it again.
Noise can be heard from the product	Noise is made by the mechanical parts of the product.	This is normal and does not mean that the product is faulty.

Grounding Instructions

This product must be grounded. If it should malfunction or break down, grounding provides a path of least resistance for the electric current to reduce the risk of electric shock. This product is equipped with a cord with an equipment-grounding conductor and a grounding plug. The plug must be plugged into an appropriate outlet that is properly installed and grounded in accordance with all local codes and ordinances.

Danger-Improper connection of the equipment-grounding conductor can result in a risk of electric shock. Check with a qualified electrician or service technician if the product will not fit the outlet, have a proper outlet installed by a qualified electrician.

This product is for use on a nominal 120V circuit and has grounding plug that looks like that plug illustrated below. Make sure that the product is connected to an outlet having the same configuration as the plug. No adapter should be used with this product.

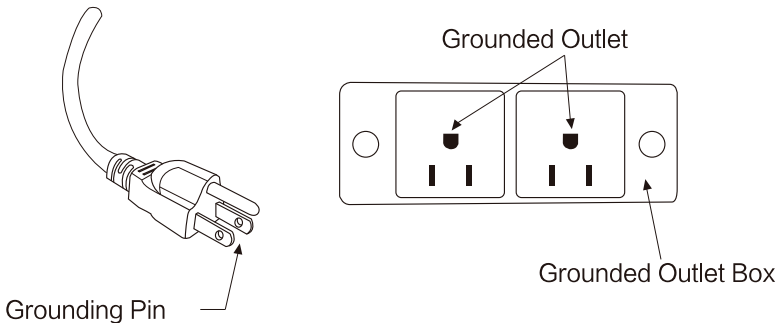

Chair Specifications

Description	Specifications
Model No.	OS-Pro Soho II
Rated Voltage	110V~120V
Rated Frequency	60Hz
Rated Power Consumption	260W
Timer	5/10/15/20/25/30 minutes
Rated Time	15 minutes
Dimensions(L x W x H)	Upright: 57.48"x29.53"x44.88"
	Reclined: 64.96"x29.53"x42.52"
Weight	Gross Weight: Approx. 245.82 lbs
	Net Weight: Approx. 205.03 lbs
Length of Wire	Controller wire: 59.0"
	Power supply wire: 70.9"
Usage Condition	Environment temperature: 32°F~95°F
	Contrasting humidity: 20-80RH
Storage Condition	Storage temperature: 23°F~95°F
	Storage humidity: 20-80RH
Safety Feature	Equipped with overheated and power
Maximum body weight of user	220 lbs

Publish:2021.03
v1.0