

TS 73 V

—

Door Closer

# EASY TO FIT, ECONOMICAL AND WITH ADJUSTABLE CLOSING FORCE

**Simple, easy installation, and guaranteed quality.**

**Tested to EN 1154**

Specially designed for internal doors, including fire doors, the DORMA TS 73 V is a universal solution for doors of differing designs and styles.

The flat and compact format of the TS 73 V means that there are practically no problems with installation; and tried and trusted quality is your assurance of reliability.

Certified to ISO 9001

**Plus points**

**For the trade**

- One model for all applications.
- Really practical solutions for special installation situations, thanks to the wide range of accessories.

**For the installer**

- Quick and simple to fit. Closing force, closing speed, and latching action all set with just a few manual adjustments.
- Only one design for DIN-L and DIN-R doors, and for standard and framefixing.

**For the designers**

- Compact format in timeless design.
- Attractively-priced solution with optimum reliability.
- Wide range of applications.

**For the user**

- Optimum wall and door protection thanks to “thinking” backcheck.
- Constant closing speed virtually unaffected by temperature fluctuations, with adjustable latch action.
- Smooth door action thanks to high mechanical efficiency.

Data and features		TS 73 V
Closing force adjustable	Size	EN 2-4
Standard doors <sup>1)</sup>	≤ 1100 mm	●
External doors, outward opening <sup>1)</sup>		-
Fire and smoke control doors <sup>1)</sup>	≤ 1100 mm	●
Non-handed		●
Arm	Standard	●
	Platform	●
	Slide channel	-
Closing force adjustable by means of setting screw		●
Closing speed adjustable at 2 separate valves	180° – 15°	●
	15° – 0°	●
Backcheck	self-regulating	●
	adjustable at valve	●
Adjustable latching action	by arm	●
Delayed action		-
Hold-open		○
Weight in kg		1.3
Dimensions in mm	Length	225
	Overall depth	40
	Height	60
Door closer tested to EN 1154		●
CE mark for construction products		●

● yes – no ○ optional

<sup>1)</sup> For high and heavy doors, external doors, and for doors required to close against high wind pressure, we recommend DORMA TS 83.



The TS 73 V complies with the requirements and/or recommendations of the following: CERTIFIRE approved for fire doors ITT 120; MM/IMM 240; Ref. CF 117

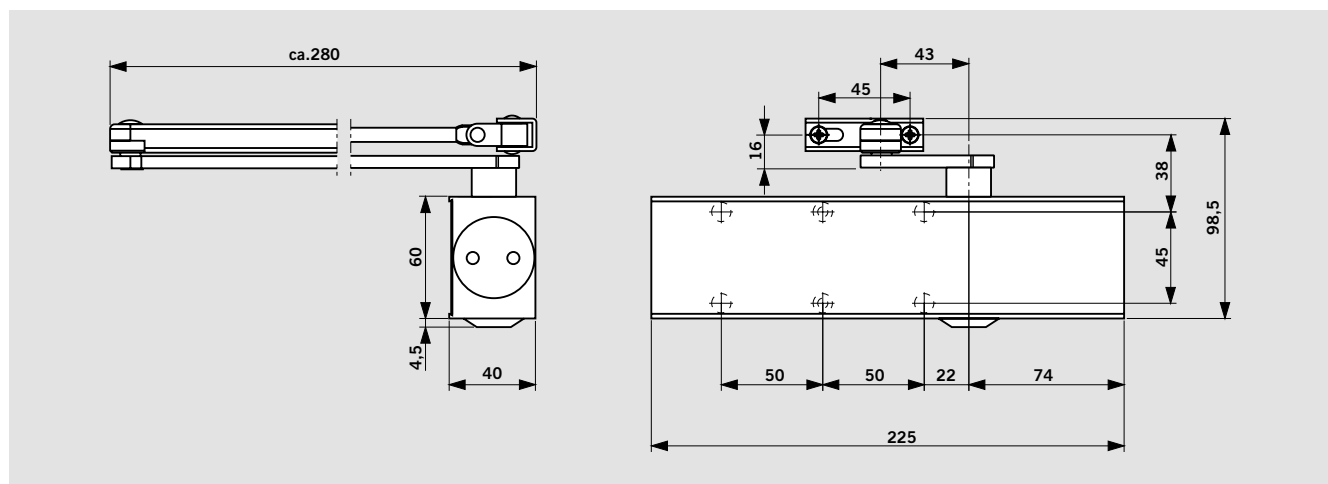

## FEATURES AND OPTIONAL FUNCTIONS

### With “thinking” backcheck (BC/ÖD)

Thanks to an innovative design concept, the resistance developed by this backcheck system as the door is opened beyond approx. 70° is directly proportional to door acceleration. It is almost imperceptible when the door is opened slowly. However, if the door is opened hastily, the backcheck responds in equal measure.

And if the door should be flung open at speed – whether deliberately, thoughtlessly, accidentally or as a result of a gust of wind – the backcheck reacts at full strength, protecting the wall and door from damage.

**If no backcheck function is required, the system can simply be switched off.**

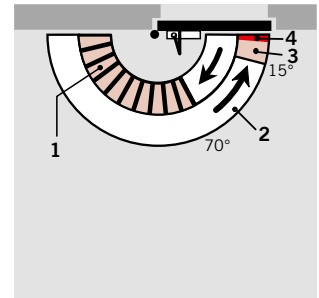

- 1 Self-regulating backcheck
- 2 Infinitely variable closing speed in the range 180° – 15°
- 3 Infinitely variable closing speed in the range 15° – 0°
- 4 Adjustable latch range (by arm)

### With hold-open arm

Combining the TS 73 V with a hold-open arm enables the door to be held open at an appropriate angle (up to approx. 150°).

Hold-open arm with switch: The hold-open function can be switched on and off by the user by simply pressing a switch.

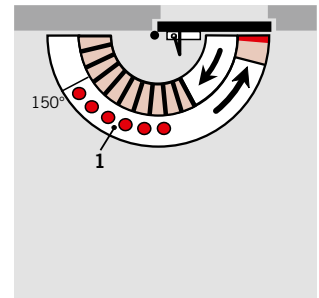

- 1 Hold-open range

**Hold-open arms are not permitted on fire doors**

## DOOR LEAF FIXING, PULL SIDE

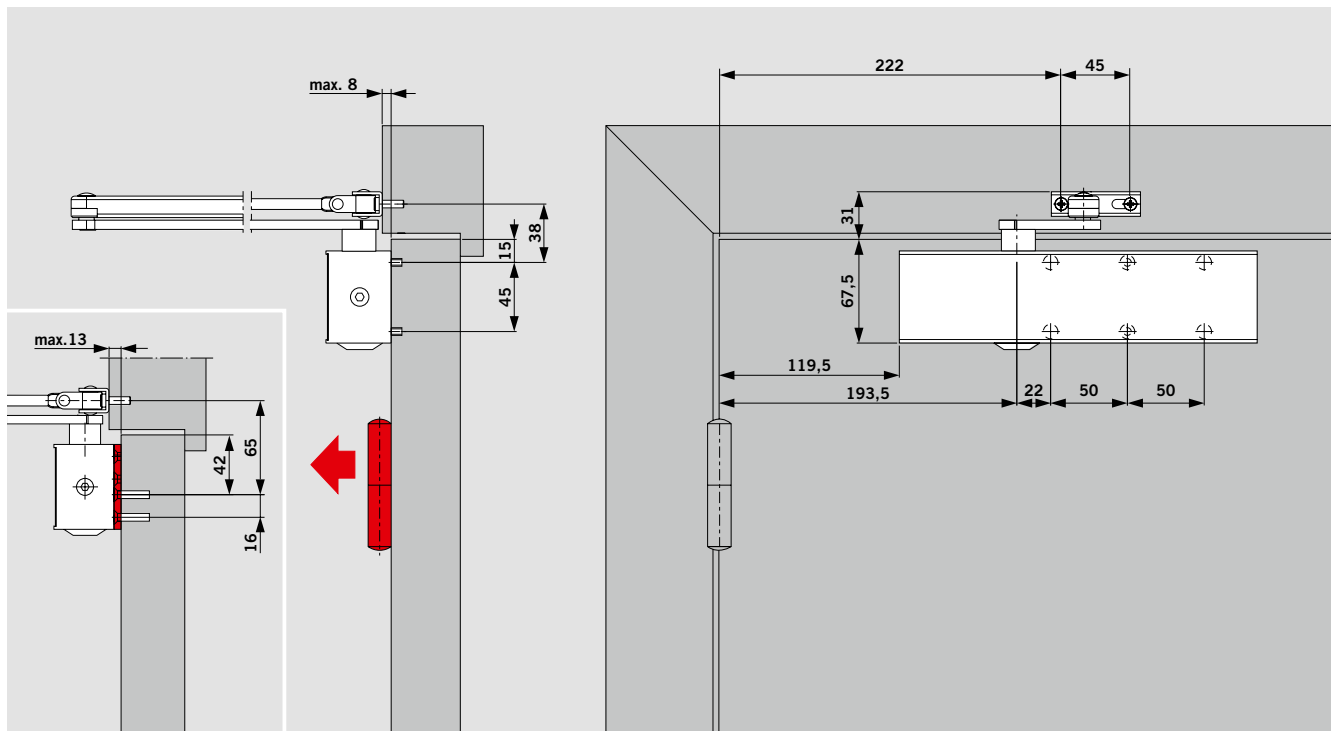

Example shows LH (ISO 6) door; RH (ISO 5) doors mirrored arrangement

## DOOR LEAF FIXING WITH HOLD-OPEN ARM

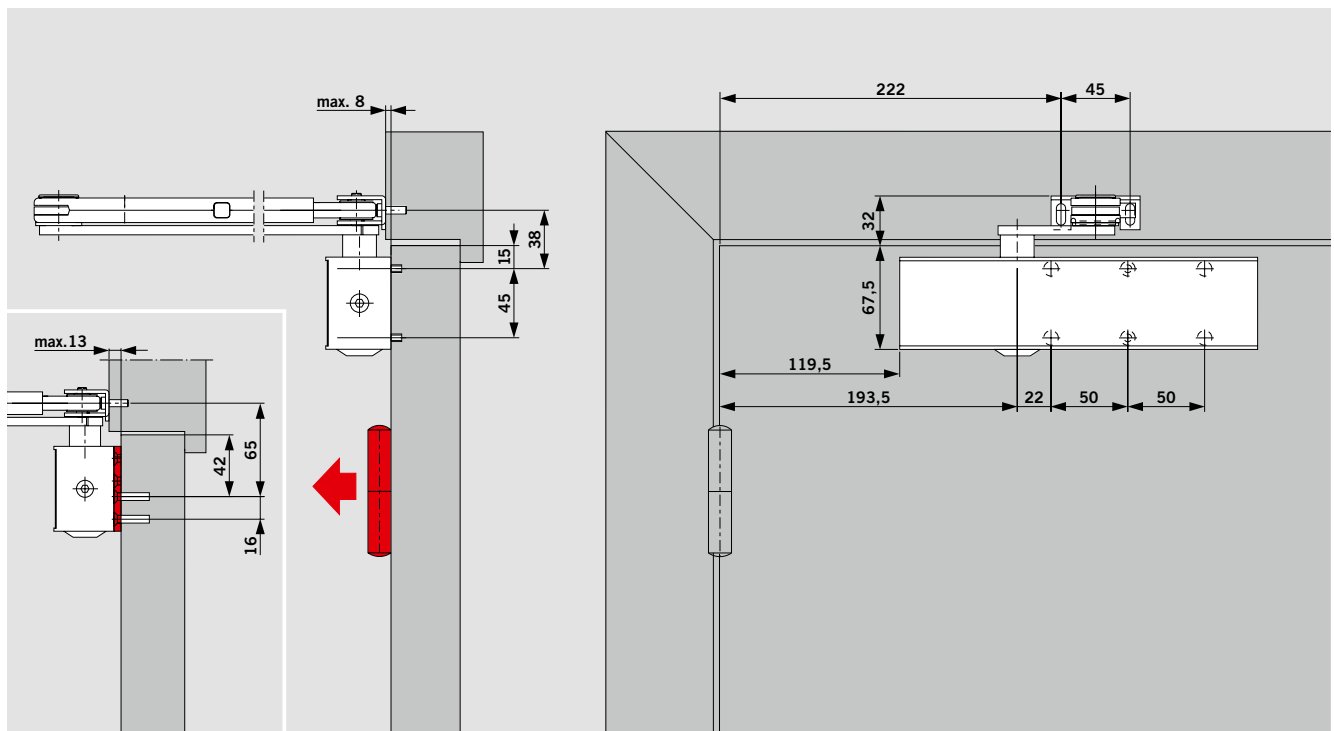

Example shows LH (ISO 6) door; RH (ISO 5) doors mirrored arrangement

## TRANSOM FIXING, PUSH SIDE

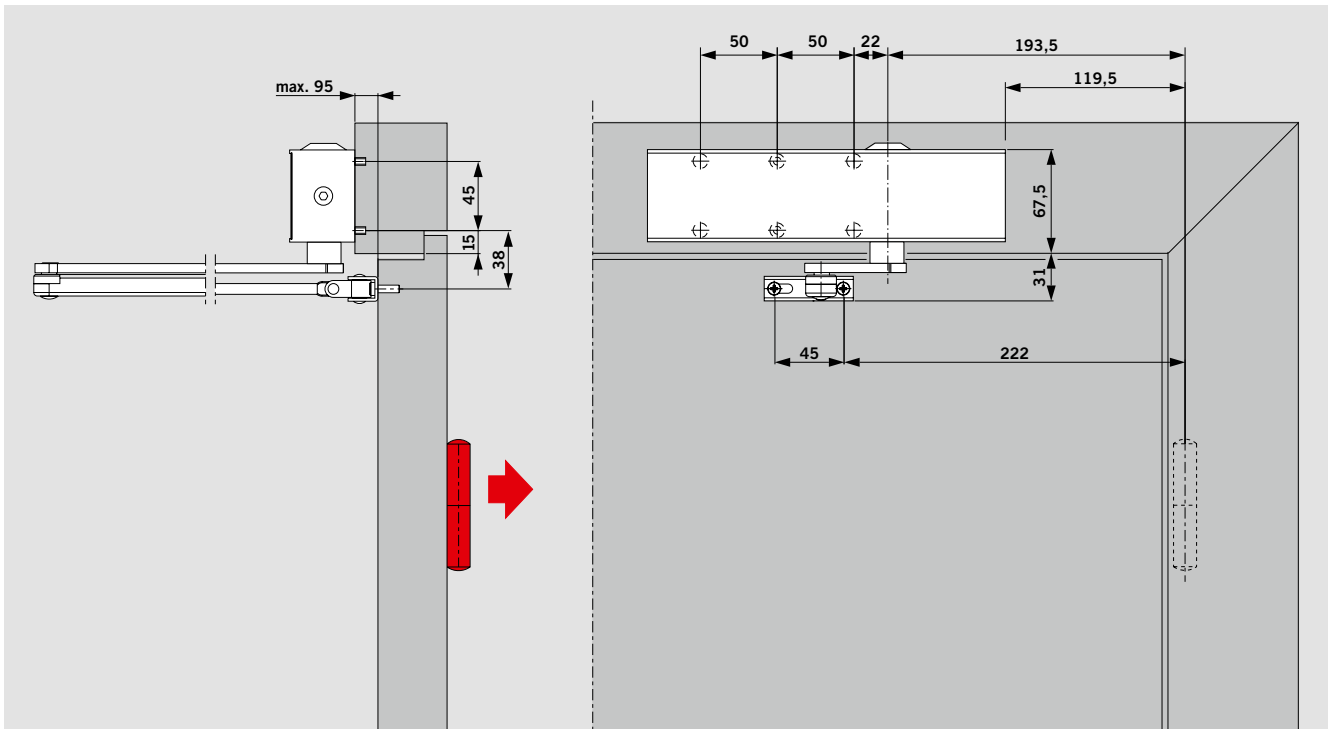

Example shows LH (ISO 6) door; RH (ISO 5) doors mirrored arrangement

Door closers may only be fitted on the frame of fire doors if proved suitable for the individual door by the issue of an approval certificate from a recognised testing institution.

# ACCESSORIES

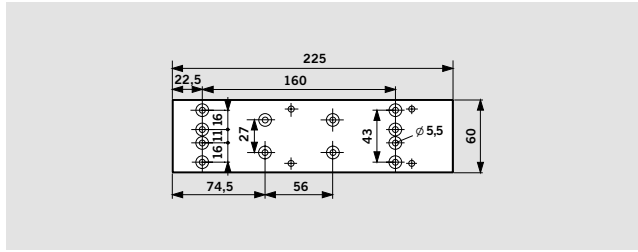
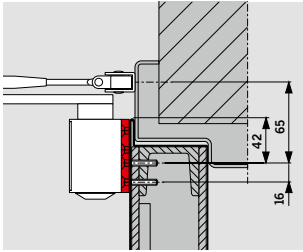

### Mounting plate TS 73 V

For use with fire and smoke check doors and also as an intermediate plate when direct fixing to the door is not possible; with fixing hole pattern to EN 1154, supplement 1.

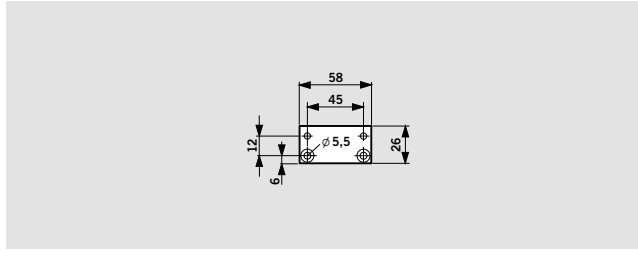
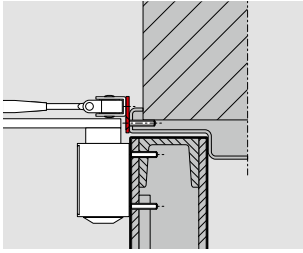

### Hinge plate TS 73 V / TS 83

For fixing the arm bracket to particularly narrow door frames.

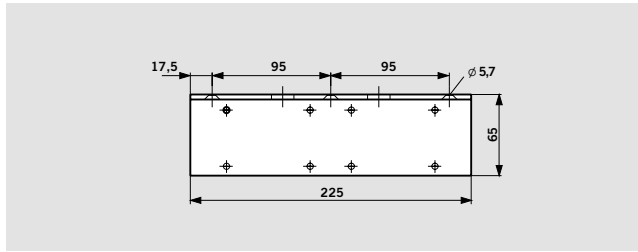
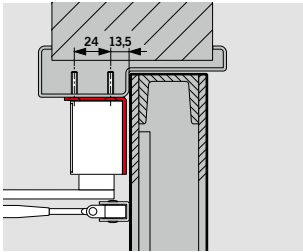

### Angle bracket TS 73 V

For frame/lintel fixing of the closer on the push side of doors with deep reveals.

**On fire and smoke check doors, proof of suitability required in relation to the individual door concerned.**

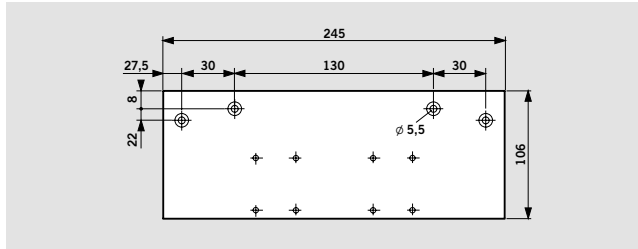
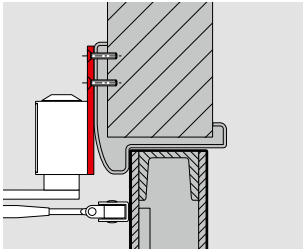

### Drop plate TS 73 V / TS 83

For installation on frame when direct fixing of closer is not possible.

**On fire and smoke check doors, proof of suitability required in relation to the individual door concerned.**

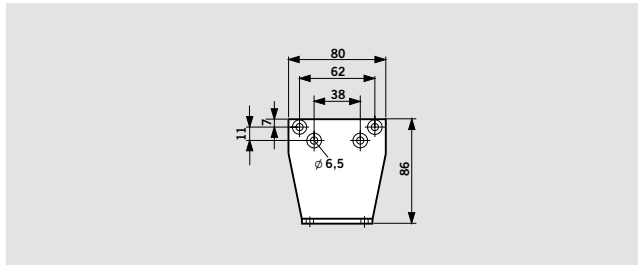
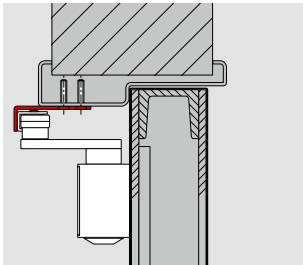

### Parallel arm bracket

#### TS 73 V / TS 83

For parallel arm installation on the push side (see fixing instructions for dimensions).

**On fire and smoke check doors, proof of suitability required in relation to the individual door concerned.**

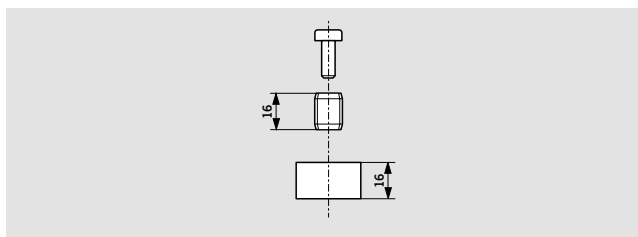
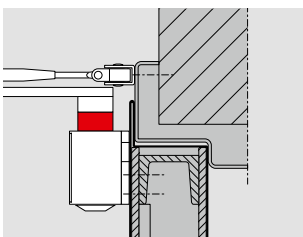







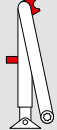

### Spindle extension

#### TS 73 V / TS 83

For increasing the distance between the closer and the arm assembly in the case of doors with a high overlap; 16 mm high.

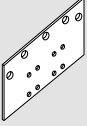
## RANGE OF EQUIPMENT AND OPTIONAL ACCESSORIES

Closer body TS 73 V	Standard arm	Platform arm	Hold-open arm with on/off switch	Mounting backplate	Hinge plate	Angle bracket	Drop plate	Parallel arm bracket	Spindel extension 16 mm
									
	<input type="checkbox"/> 220023xx	<input type="checkbox"/> 830001xx	<input type="checkbox"/> 220030xx	370001xx	830014xx	370003xx	380002xx	280066xx	83003705
Size EN 2-4	<input checked="" type="checkbox"/> <input type="checkbox"/>	<input checked="" type="checkbox"/> <input type="checkbox"/>	<input checked="" type="checkbox"/> <input type="checkbox"/>	<input type="checkbox"/>	<input type="checkbox"/>	<input type="checkbox"/>	<input type="checkbox"/>	<input type="checkbox"/>	<input type="checkbox"/>
<input checked="" type="checkbox"/> 370101xx									

- Body only
- Arm only
- Optional accessory

xx	Colour
01	Silver
11	White (RAL 9016)
09	Special colour

## SPECIFICATION TEXT

Rack and pinion door closer; with adjustable power size EN 2 – 4, according to EN 1154, carries the CE mark, integral self-regulating back-check; closing speed adjustable in two independent ranges and adjustable latch action. Non-handed.

**Model**

- with standard arm
- with platform arm
- with hold-open arm with on/off switch

### Accessories

**Colour**

- silver
- white (sim. to RAL 9016)
- special colour (sim. to RAL)

**Make**  
DORMA TS 73 V



DORMA GmbH+Co. KG  
DORMA Platz 1  
58256 ENNEPITAL  
GERMANY  
Phone +49 2333 793-0  
Fax +49 2333 793-4950  
[www.dorma.com](http://www.dorma.com)