



BATISTA GOMES



PORTÕES DE CORRER / PORTÕES DE ABRIR

CATÁLOGO

FERRAGENS SERRALHARIA
ACESSÓRIOS PARA PORTÕES

	PORTÕES AUTOPORTANTES
	Pág: 3 » 7
	PORTÕES DE CORRER - APOIADOS
	Pág: 8 » 17
	PORTÕES DE CORRER - SUSPENSOS
	Pág: 8 » 17
	PORTÕES DE ABRIR
	Pág: 18 » 25
	FECHADURAS E FECHOS
	Pág: 26 » 30
	PEÇAS DECORATIVAS - PORTÕES/GRADEAMENTOS
	Pág: 31 » 33
	DISCOS - RÍGIDOS / DIAMANTADOS
	Pág: 34 » 39

ACABAMENTOS

- AN - Alumínio Natural (sem anodização)
- ALBr - Alumínio Lacado Branco
- ALPr - Alumínio Lacado Preto
- ALVd - Alumínio Lacado Verde
- ALCt - Alumínio Lacado Castanho
- AL - Alumínio Lacado Outros (indicar)
- FP - Aço Natural (sem tratamento galvânico)
- FZ - Aço Zincado (galvanizado)
- IN (INOX) - Inox Natural 304



Portão de correr



Portão de abrir



Capacidade carga máxima



Com 1 rolamento de esferas

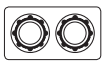

Com 2 rolamentos de esferas



Canal em V



Canal em U



Reversível / Ambidextro



Com mola



Portão de batente



Direita / Esquerda



Largura portão



Rotação até 360º





Norma certificada

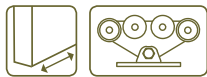

Marcação CE



SISTEMA	 MAX.	
2140	250kg	MAX. 3,5mt
2160	550kg	MAX. 5mt
2170*	600kg	MAX. 8mt
2180*	1000kg	MAX. 12mt

* Por consulta



SISTEMAS DE ACESSÓRIOS PARA PORTÕES AUTOPORTANTES

CANTILEVER



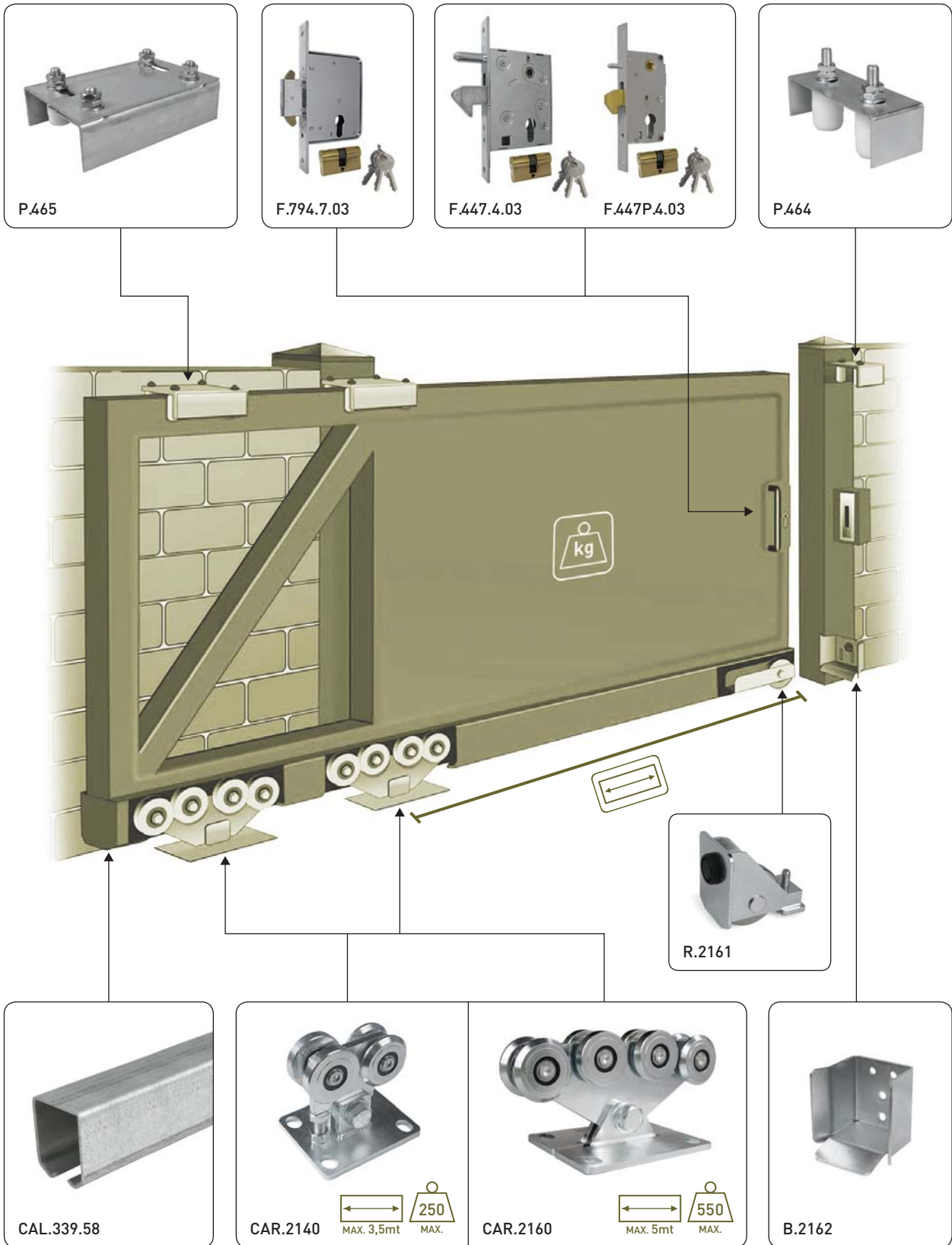
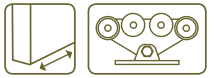

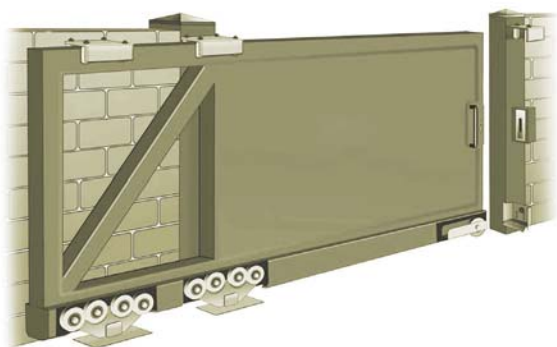

**NEW
NOVO**

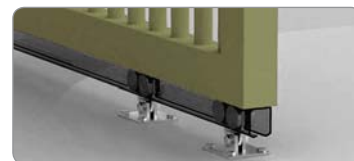

CAL.339

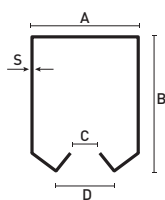

Calha com L=3m

Calha para portões de correr

REF.	ACB	A	B	C	D	S	
CAL.339.58	FZ	57	66	15	31	3.5	3m

REF.	COMPATÍVEL COM
CAL.339.58	CAR.2140 - CAR.2160 - CAR.330.54 - CAR.331.54

CAR.2140

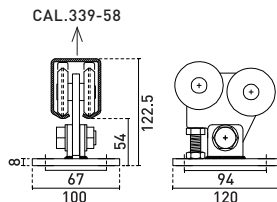
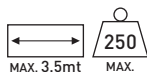

Carro para portões de correr

REF.	ACB	R	Cap.	
CAR.2140	FZ		250kg	1

R = Rolamento esferas
Cap. = Capacidade kg (2 peças)
Abertura máxima: 3,5mt

Compatível com: CAL.339.58



CAR.2160

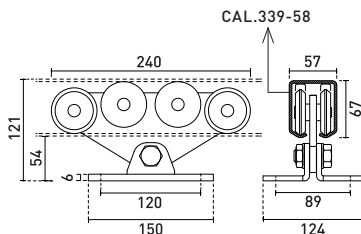
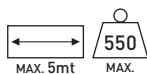

Carro para portões de correr

REF.	ACB	R	Cap.	
CAR.2160	FZ		550kg	1

R = Rolamento esferas
Cap. = Capacidade kg (2 peças)
Abertura máxima: 5mt

Compatível com: CAL.339.58



R.2161

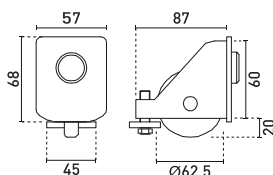

Roda fim curso

REF.	ACB	
R.2161	FZ	1

B.2162

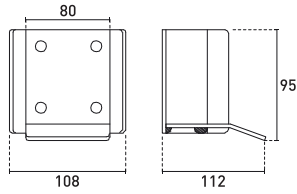

Batente

REF.	ACB	
B.2162	FZ	1

S.2164

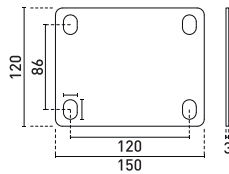

Suporte (base)

REF.	ACB	
S.2164	FZ	1

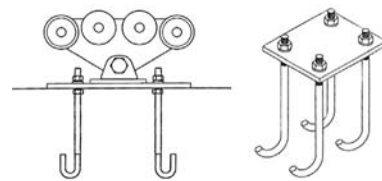

S.2165

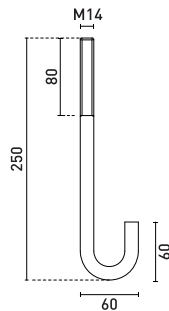

Suporte fixação (para S.2164)

REF.	ACB	
S.2165	FZ	1

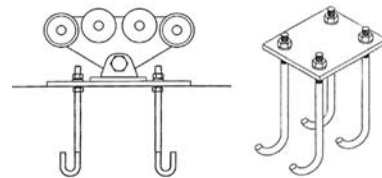

S.2167

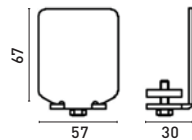

Suporte para batente

REF.	ACB	
S.2167	FZ	1

S.2176

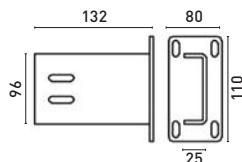

Suporte para batente

REF.	ACB	
S.2176	FZ	1



P.464

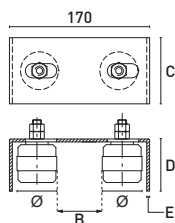

Placa guia com 2 rolamentos em Nylon reguláveis

REF.	ACB	Ø	B	C	D	E	
P.464	FZ	42	30-70	70	65	3	10



P.465
P.965 - INOX

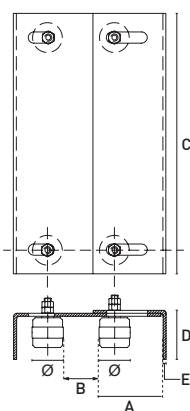

Placa guia com 4 rolamentos em Nylon reguláveis

REF.	ACB	Ø	A	B	C	D	E	
P.465-P	FZ	32	38-70	15-65	220	55	3	5
P.465-G	FZ	42	52-97	45-105	350	65	3	5
P.965-P	INOX	32	38-70	15-65	220	55	4	5



FECHADURAS



Consultar Fechaduras para Portões

Pag: 26/28

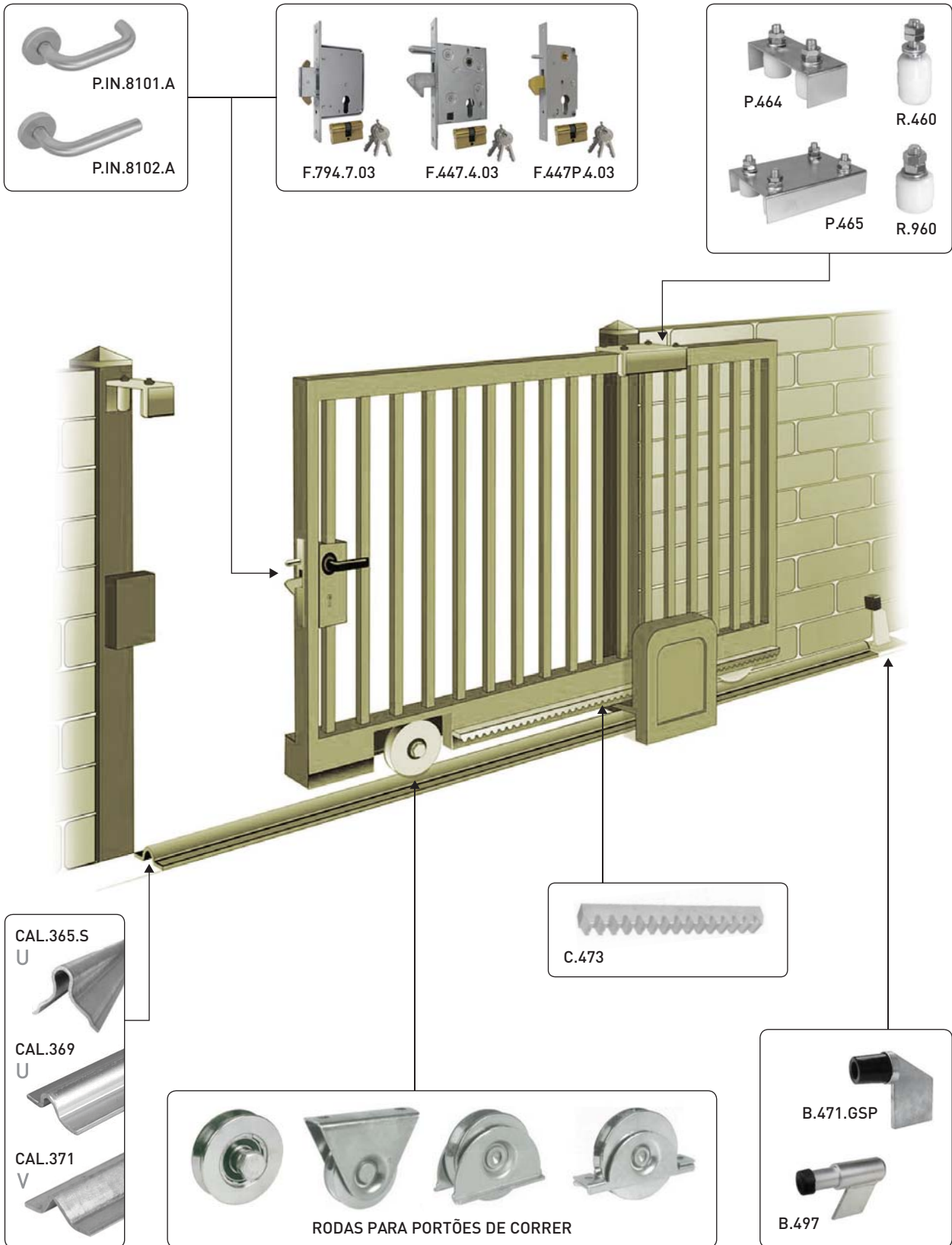



FERRAGENS SERRALHARIA ACESSÓRIOS PARA PORTÕES DE CORRER - SUSPENSOS

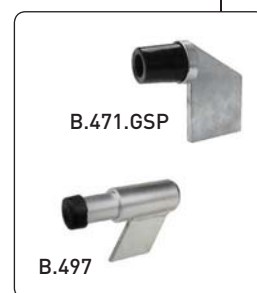
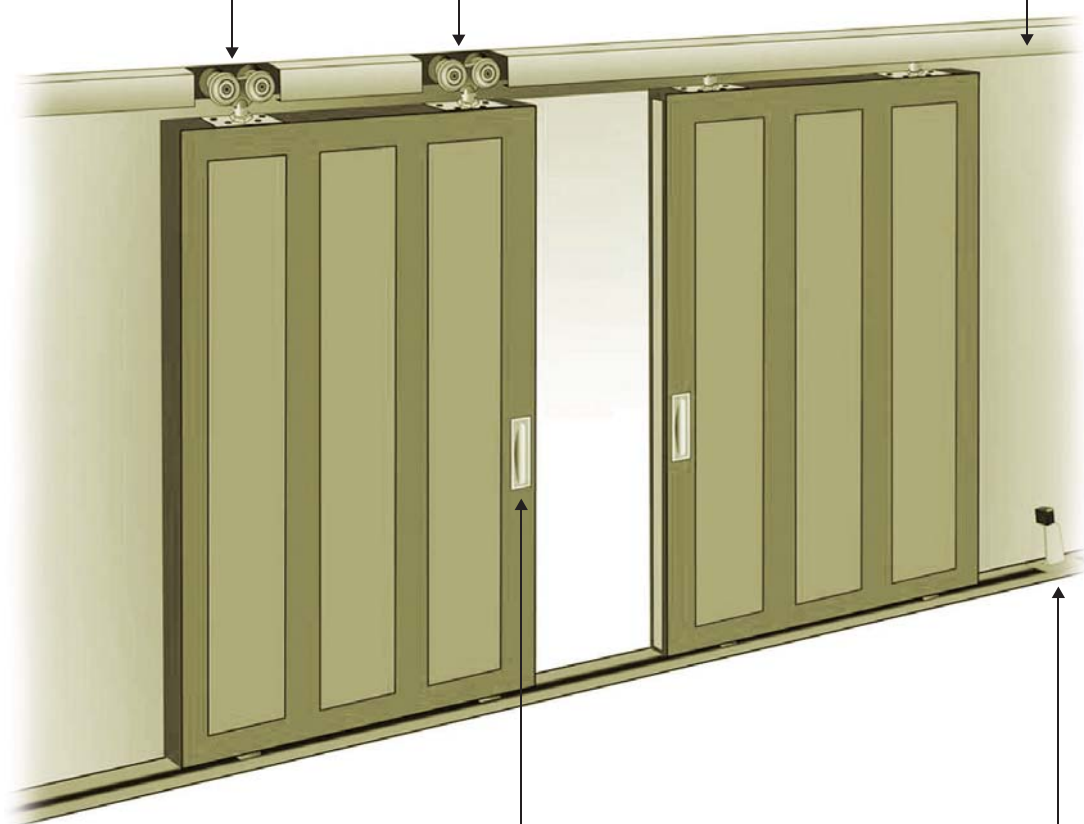

R.360

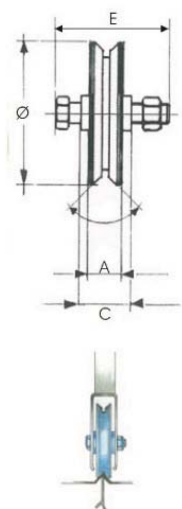

Em Inox ver:
R.962

Roda para portões correr com 1 rolamento - Canal em V

REF.	ACB	Ø	A	C	E	kg	
R.360.50	FZ	50	17	19	10x45	60	48
R.360.60	FZ	60	17	24	10x45	200	48
R.360.80	FZ	80	20	33	14x60	300	24
R.360.100	FZ	100	20	33	14x60	400	10
R.360.120	FZ	120	20	33	14x60	400	10
R.360.140	FZ	140	26	44	16x70	600	10

kg - capacidade carga 2 rodas

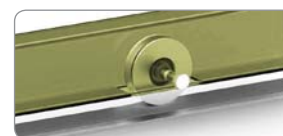

R.361 R.364

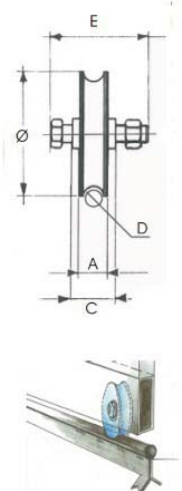

Em Inox ver:
R.961
R.964

Roda para portões correr com 1 rolamento - Canal em U

REF.	ACB	Ø	A	C	D Canal	E	kg	
R.361.60	FZ	60	17	24	12	10x45	200	48
R.361.80	FZ	80	20	33	16	14x60	300	24
R.361.100	FZ	100	20	33	16	14x60	400	10
R.361.120	FZ	120	20	33	16	14x60	400	10
R.364.80	FZ	80	25	33	20	14x60	300	10
R.364.100	FZ	100	25	33	20	14x60	400	10

kg - capacidade carga 2 rodas

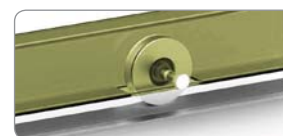

R.362

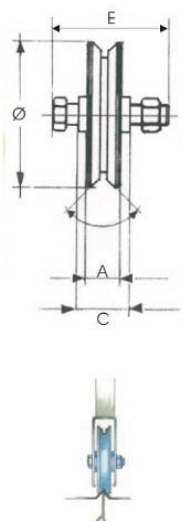
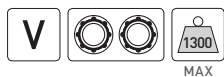

Roda para portões correr com 2 rolamentos - Canal em V

REF.	ACB	Ø	A	C	E	kg	
R.362.80	FZ	80	30	44	14x70	500	20
R.362.100	FZ	100	30	44	14x70	700	6
R.362.120	FZ	120	30	44	14x70	900	6
R.362.140	FZ	140	32	44	16x70	1000	4
R.362.160	FZ	160	32	44	16x70	1200	4
R.362.200	FZ	200	32	44	16x70	1300	2

kg - capacidade carga 2 rodas

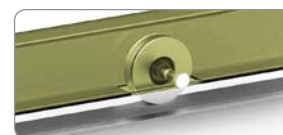



FERRAGENS SERRALHARIA RODAS PARA PORTÕES DE CORRER



R.363

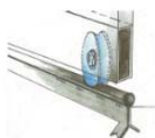
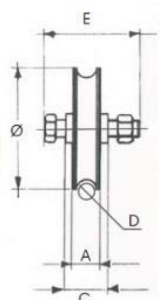
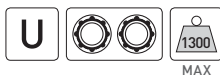

Roda para portões correr com 2 rolamentos - Canal em U

REF.	ACB	Ø	A	C	D Canal	E	kg	
R.363.80	FZ	80	30	44	20	14x70	500	10
R.363.100	FZ	100	30	44	20	14x70	700	6
R.363.120	FZ	120	30	44	20	14x70	900	6
R.363.140	FZ	140	32	44	20	16x70	1000	4
R.363.160	FZ	160	32	44	20	16x70	1200	4
R.363.200	FZ	200	32	44	20	16x70	1300	2

kg - capacidade carga 2 rodas

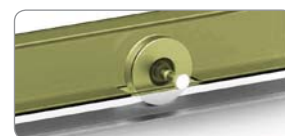

R.962 - INOX

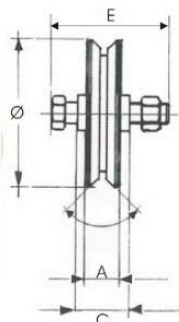

Roda para portões correr com 1 rolamento - Canal em V

REF.	ACB	Ø	A	C	E	kg	
R.962.80	INOX	80	20	33	14x60	300	24
R.962.100	INOX	100	20	33	14x60	400	10
R.962.120	INOX	120	20	33	14x60	400	10

kg - capacidade carga 2 rodas

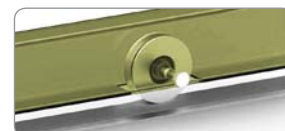

Em Aço Zincado ver:
R.362

R.961 - INOX
R.964 - INOX

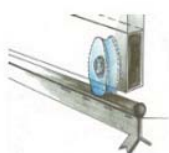
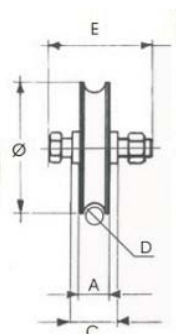

Roda para portões correr com 1 rolamento - Canal em U

REF.	ACB	Ø	A	C	D Canal	E	kg	
R.961.100	INOX	100	20	33	16	14x60	400	10
R.964.80	INOX	80	25	33	20	14x60	300	24
R.964.100	INOX	100	25	33	20	14x60	400	10
R.964.120	INOX	120	25	33	20	14x60	400	10

kg - capacidade carga 2 rodas

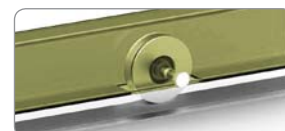

Em Aço Zincado ver:
R.361
R.364

R.385

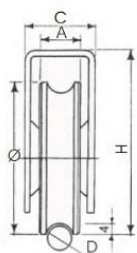

Roda para portões correr com suporte externo com 1 rolamento - Canal em U

REF.	ACB	Ø	A	C	D Canal	H	kg	
R.385.80	FZ	80	20	37	16	95	300	10
R.385.100	FZ	100	20	37	16	105	350	6

kg - capacidade carga 2 rodas



R.386

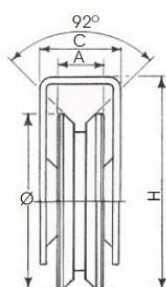

Roda para portões correr com suporte externo com 1 rolamento - Canal em V

REF.	ACB	Ø	A	C	H	kg	
R.386.80	FZ	80	20	37	95	300	10
R.386.100	FZ	100	20	37	105	350	6

kg - capacidade carga 2 rodas

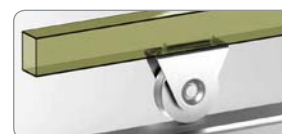

R.387

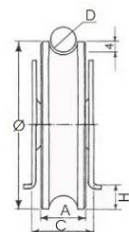

Roda para portões correr com suporte lateral com 1 rolamento - Canal em U

REF.	ACB	Ø	A	C	D Canal	H	kg	
R.387.60	FZ	60	17	33	12	12	150	10
R.387.80	FZ	80	20	33	16	15	300	10
R.387.100	FZ	100	20	33	16	25	350	10
R.387.120	FZ	120	20	33	16	18	400	10

kg - capacidade carga 2 rodas



R.388

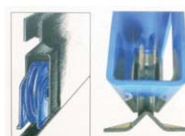
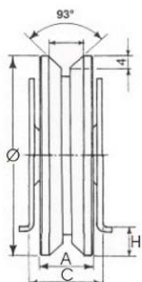

Roda para portões correr com suporte lateral com 1 rolamento - Canal em V

REF.	ACB	Ø	A	C	H	kg	
R.388.60	FZ	60	17	23	11	150	10
R.388.80	FZ	80	20	33	15	300	10
R.388.100	FZ	100	20	33	25	350	10
R.388.120	FZ	120	20	33	18	400	6
R.388.140	FZ	140	25	34	28	600	10

kg - capacidade carga 2 rodas





FERRAGENS SERRALHARIA RODAS PARA PORTÕES DE CORRER



R.392

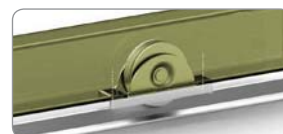
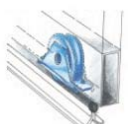
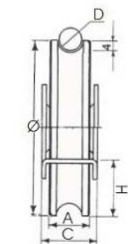

Roda para portões correr com suporte interno com 1 rolamento - Canal em U

REF.	ACB	Ø	A	C	D Canal	H	kg	
R.392.80	FZ	80	22	33	16	25	250	10
R.392.100	FZ	100	11	33	16	35	300	10
R.392.120	FZ	120	22	33	16	39	400	4
R.392L.80	FZ	80	25	34	20	25	250	6
R.392L.100	FZ	100	25	34	20	35	300	6

kg - capacidade carga 2 rodas

R.393

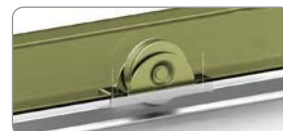
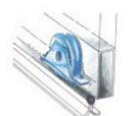
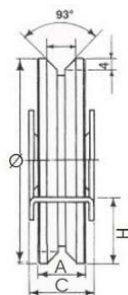

Roda para portões correr com suporte interno com 1 rolamento - Canal em V

REF.	ACB	Ø	A	C	H	kg	
R.393.80	FZ	80	20	33	25	250	10
R.393.100	FZ	100	20	33	35	300	10
R.393.120	FZ	120	20	34	39	400	6
R.393.140	FZ	140	25	34	49	600	

kg - capacidade carga 2 rodas

Em Inox ver:
R.993

R.993 - INOX

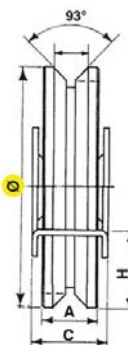

Roda para portões correr com suporte interno com 1 rolamento - Canal em V

REF.	ACB	Ø	A	C	H	kg	
R.993.80	INOX	80	20	33	25	250	4
R.993.100	INOX	100	20	33	35	300	

kg - capacidade carga 2 rodas

Em Aço Zincado ver:
R.393



CAL.365.S



U

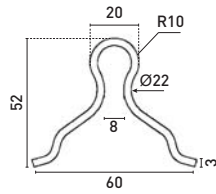

Calha para portões - Perfil em U

REF.	ACB	
CAL.365.S	FZ	3m

Calha com 3m para chumbar
Aplicar em portões de correr
Perno de junção Ref. P.365.A

P.365.A

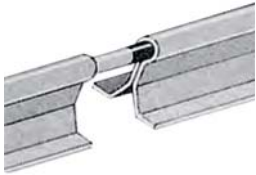

Perno junção para calha CAL.365

REF.	ACB	
P.365.A	FZ	10

CAL.369 - INOX CAL.369 CAL.369.P



U

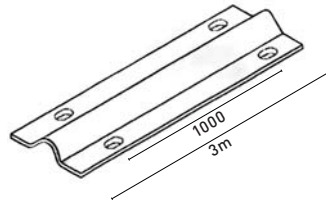
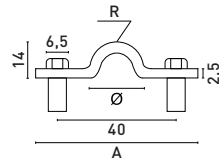

Calha para portões - Perfil em U

REF.	ACB	A	R	Ø	
CAL.369	INOX	55	10	20	3m
CAL.369	FZ	53	10	20	
CAL.369.P	FZ	56	8	16	

Calha com 3m para aparafusar, perfil em U
Aplicar em portões de correr

CAL.371



V

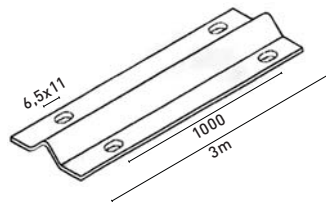
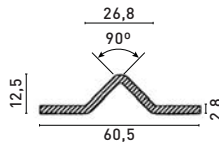

Calha para portões - Perfil em V

REF.	ACB	
CAL.371	FZ	3m

Calha com 3m para aparafusar, perfil em V
Aplicar em portões de correr

C.473 C.973 - INOX S.473.A



C.473
C.973



S.473.A

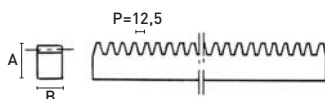

Cremalheira dentada para portões de correr Suporte para Cremalheira

REF.	ACB	A	B	
C.473.22x22	FZ	22	22	1
C.473.30x12	FZ	30	12	1
C.973.22x22	INOX	22	22	1
C.973.30x12	INOX	30	12	1
S.473.A	FZ	-	-	6

Barra com 1m



CAL.339 - INOX
CAL.339

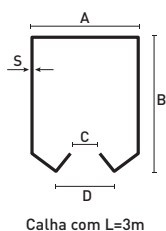

Calha para portões de correr - INOX

REF.	ACB	A	B	C	D	S	
CAL.339.42	INOX	42	54	10	21	2.5	3m
CAL.339.42	FZ	42	54	10	21	2.5	
CAL.339.58	FZ	57	66	15	31	3.5	

REF.	COMPATÍVEL COM
CAL.339.42 - INOX	CAR.330.40 - CAR.331.40 - CAR.331.44 INOX
CAL.339.42	
CAL.339.58	CAR.330.54 - CAR.331.54 - CAR.2140 - CAR.2160

CAR.12

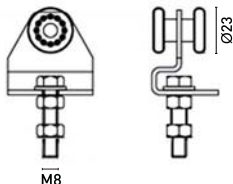

Carro para portões de correr

REF.	ACB	R	M	
CAR.12	FZ	Ø23	M8	25

R = Rolamento esferas
P = Parafuso

CAR.14

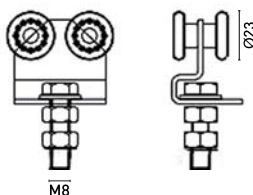

Carro para portões de correr

REF.	ACB	R	M	
CAR.14	FZ	Ø23	M8	25

R = Rolamento esferas
M = Parafuso

CAR.20
CAR.20.PT

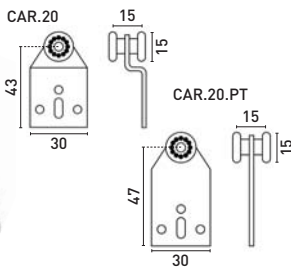

Carro para portões de correr

REF.	ACB	
CAR.20	FZ	50
CAR.20.PT	FZ	

R = Rolamento esferas

CAR.330

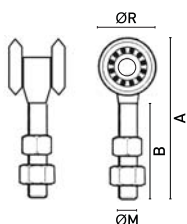

Carro para portões de correr

REF.	ACB	R	M	A	B	Cap.	
CAR.330.24	FZ	Ø24	8	65	35	60kg	40
CAR.330.40	FZ	Ø40	12	110	58	150kg	25
CAR.330.54	FZ	Ø54	20	150	95	400kg	6

Compatível com: CAL.339.xx

CAR.331
CAR.331 - INOX

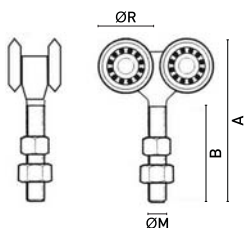

Carro para portões de correr

REF.	ACB	R	M	A	B	Cap.	
CAR.331.24	FZ	Ø24	8	60	35	85kg	20
CAR.331.40	FZ	Ø40	12	125	58	350kg	25
CAR.331.54	FZ	Ø54	20	150	95	750kg	10

REF.	COMPATÍVEL COM
CAR.331.44	INOX
	Ø42
	12
	125
	58
	450kg
	6

REF.	COMPATÍVEL COM
CAR.331.40	CAL.339.42
CAR.331.44 - INOX	CAL.339.42 - INOX
CAR.331.54	CAL.339.58

R = Rolamento esferas
Cap. = Capacidade kg (2 peças)

PL.336

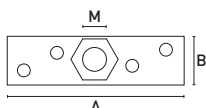

Placa para carros para portões de correr

REF.	ACB	M	A	B	
PL.336-12	FZ	12	155	25	25

M = Parafuso



R.460

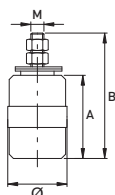

Rolamento em Nylon para portões de correr

REF.	ACB	Ø	A	B	M	
R.460.25	FZ	25	31	72	12	20
R.460.32	FZ	32	34	74	14	10
R.460.42	FZ	42	59	104	14	

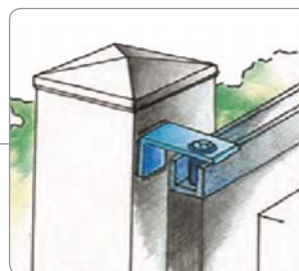

R.960 - INOX

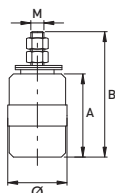

Rolamento em Nylon para portões de correr

REF.	ACB	Ø	A	B	M	
R.960.32	INOX	32	34	74	14	10
R.960.42	INOX	42	40	74	14	

P.464

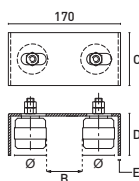

Placa guia com 2 rolamentos em Nylon reguláveis

REF.	ACB	Ø	B	C	D	E	
P.464	FZ	42	30-70	70	65	3	10

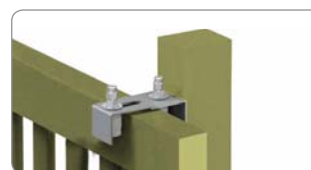

P.465

P.965 - INOX

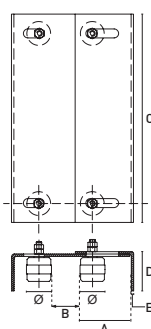

Placa guia com 4 rolamentos em Nylon reguláveis

REF.	ACB	Ø	A	B	C	D	E	
P.465-P	FZ	32	38-70	15-65	220	55	3	5
P.465-G	FZ	42	52-97	45-105	350	65	3	5
P.965-P	INOX	32	38-70	15-65	220	55	4	5



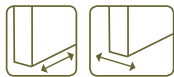

CE.485.P

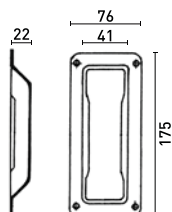

Concha de embutir

REF.	ACB	
CE.485/P	FZ	12

B.471.GSP

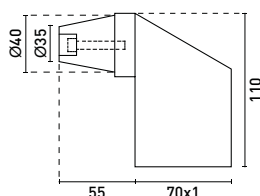

Batente para portões de correr

REF.	ACB	
B.471.GSP	FZ	5

B.497

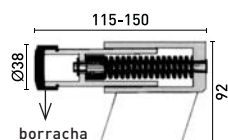

Batente para portões de correr com mola

REF.	ACB	
B.497	FZ	5

B.470

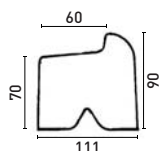

Batente para portões de abrir

REF.	ACB	
B.470	FZ	16

B.470.V

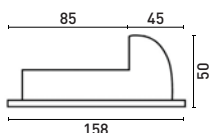

Batente para portões de abrir para sobrepor/ aparafusar

REF.	ACB	
B.470.V	FZ	20

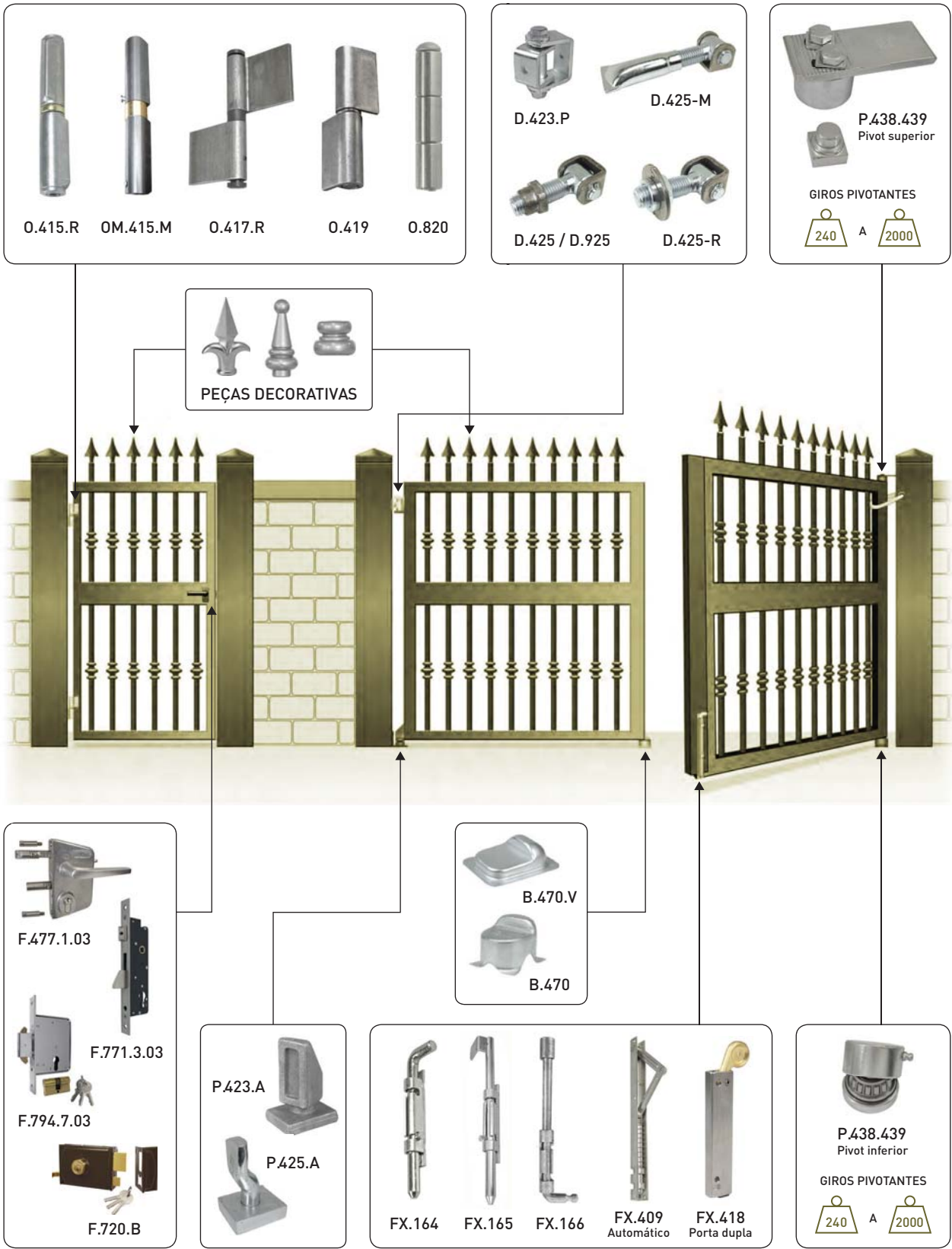



FERRAGENS SERRALHARIA GIROS PIVOTANTES PARA PORTÕES DE ABRIR



Jogo giros pivotantes

(Pivot Superior + Inferior)

Com rolamentos de esferas

Rotação 360° - Ambidextros

Para portões com batente ou vai-vem

Capacidades de carga (kg):
240 / 500 / 1000 e 2000kg

Material / Acabamentos:

Aço Zincado

Aço Inox Aisi 304

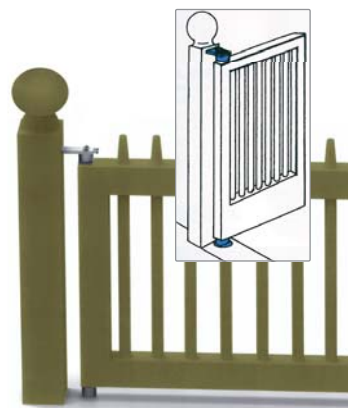
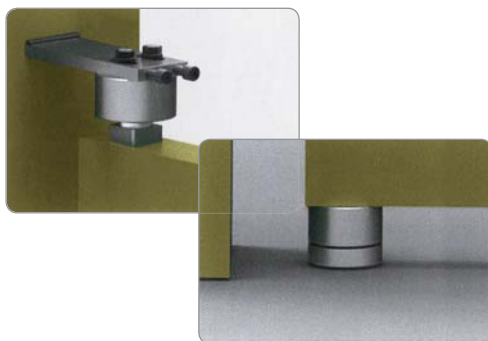

Produto testado conforme norma:
UNI EN13241-1

Marcação:

CE 2006/42/CE

Kg Capacidade carga
Charge capacity

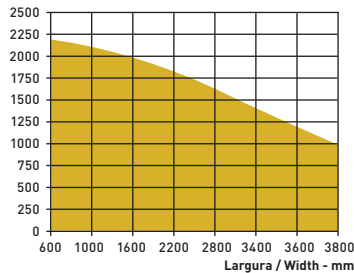

P.448.449 / P.948.949

Kg Capacidade carga
Charge capacity

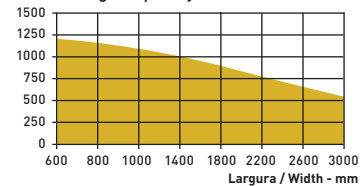

P.438.439 / P.938.939

P.438.439.P

Ø45

240kg

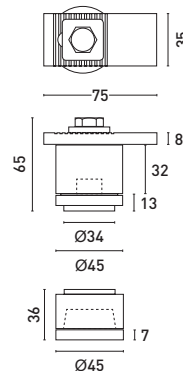
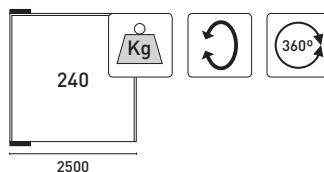

Aço Zincado

1 Jogo

P.438.439

Ø50

500kg

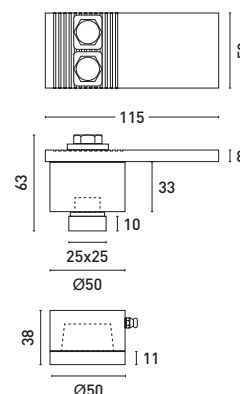
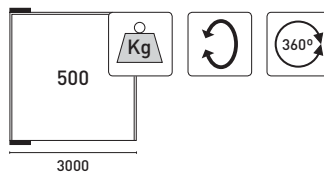

Aço Zincado

1 Jogo



P.448.449
Ø70
1000kg

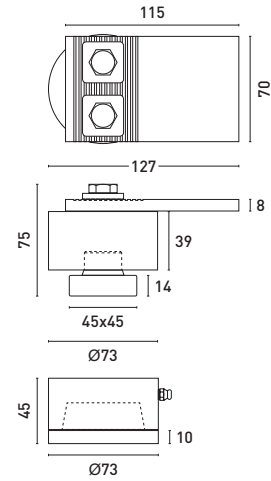
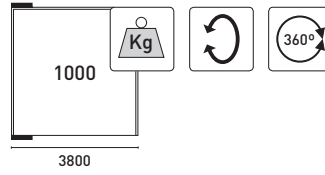

Aço Zincado

1 Jogo

P.448.449.G
Ø118
2000kg

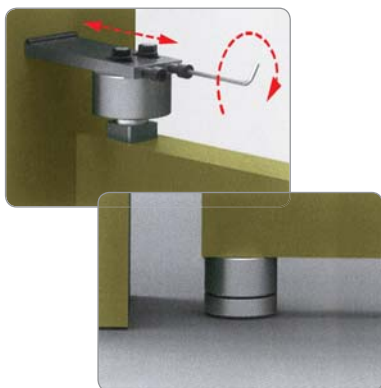
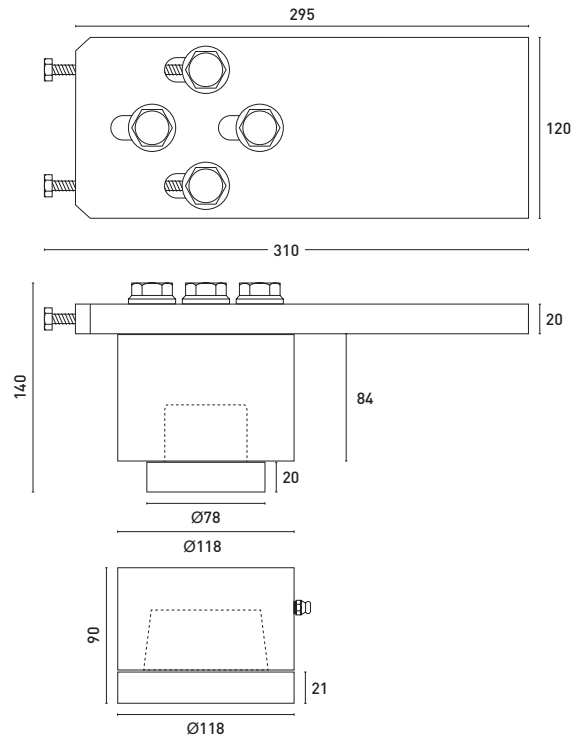
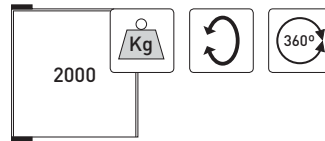

Aço Zincado

1 Jogo



FERRAGENS SERRALHARIA

GIROS PIVOTANTES PARA PORTÕES DE ABRIR



P.938.939
Ø50
500kg

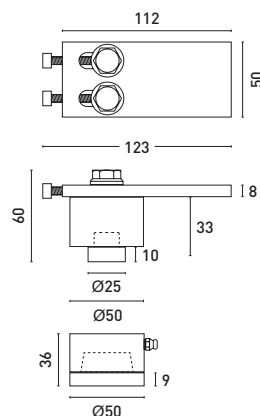
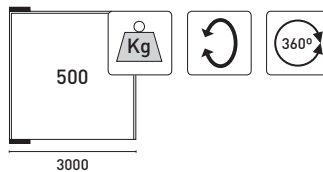

INOX 304
STAINLESS STEEL

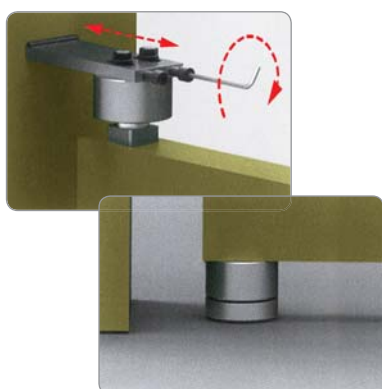

Inox Aisi 304

1 Jogo

P.948.949
Ø70
1000kg

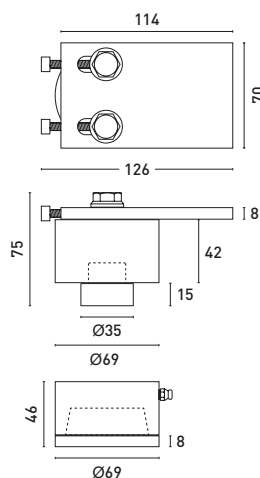
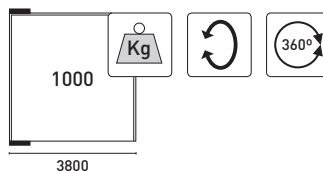

INOX 304
STAINLESS STEEL

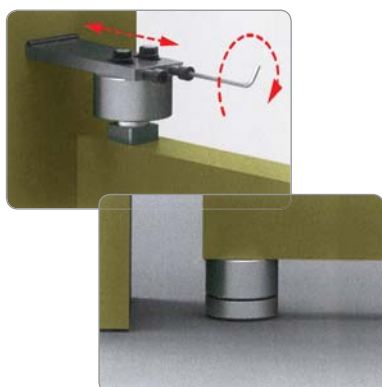

Inox Aisi 304

1 Jogo



P.423.A

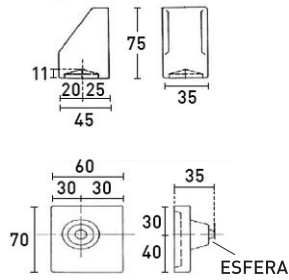
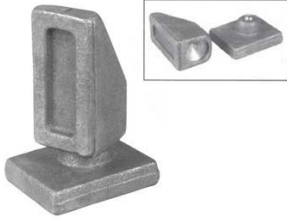

Pivot com placa inferior com esfera

REF.	ACB	
P.423.A	FP	6

P.425.A

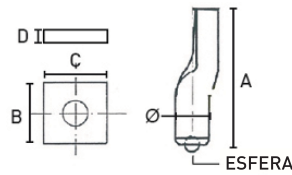

Pivot com esfera e placa inferior

REF.	ACB	Ø	A	B	C	D	
P.425.A.20	FP	20	89	63	60	15	10
P.425.A.24	FP	24	96	60	60	20	6

CH.59.A

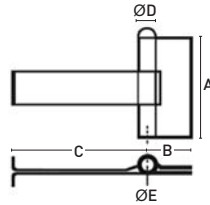

Dobradiça para soldar com chumbadouro

REF.	ACB	A	B	C	D	E	
CH.59.Ax2½	FP	66	42	95	16	10	24
CH.59.Ax3	FP	75	46	115	17	12	
CH.59.Ax3½	FP	90	46	115	17	12	

D.423.P

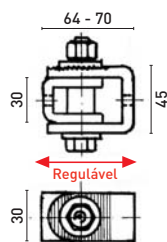
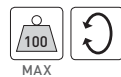

Dobradiça regulável

REF.	ACB	Cap.	
D.423.P	FZ	100kg	10

Cap. = Capacidade kg (2 peças)

D.425
D.925 - INOX

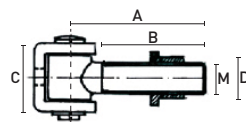
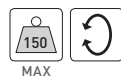

Dobradiça regulável

REF.	ACB	M	A	B	C	D	Cap.	
D.425.16	FZ	16	53	35	43	26	60kg	10
D.425.20	FZ	20	75	50	41	25	100kg	10
D.425.24	FZ	24	72	50	47	30	150kg	5
D.925.20	INOX	20	75	50	41	25	100kg	10

M = Ø Rosca
Cap. = Capacidade kg (2 peças)



D.425-M

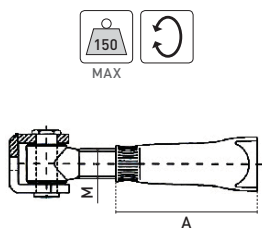

Dobradiça regulável com tubo para chumbar

REF.	ACB	M	A	Cap.	
D.425-M.20	FZ	20	95	100kg	10
D.425-M.24	FZ	24	100	150kg	5

M = Ø Rosca
Cap. = Capacidade kg (2 peças)

D.425-R

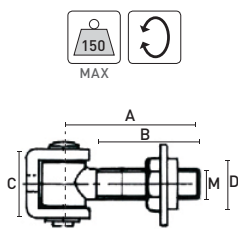

Dobradiça regulável

REF.	ACB	M	A	B	C	D	Cap.	
D.425-R.20	FZ	20	72	52	41	30	100kg	10
D.425-R.24	FZ	24	72	50	47	36	150kg	5

M = Ø Rosca
Cap. = Capacidade kg (2 peças)

D.428

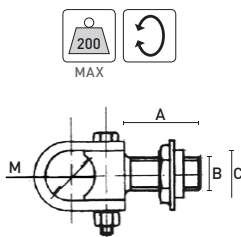

Dobradiça regulável

REF.	ACB	Ø	A	B	C	Cap.	
D.428.30	FZ	30	48	20	48	100kg	6
D.428.35	FZ	35	55	24	55	150kg	6
D.428.40	FZ	40	70	30	70	200kg	6

Cap. = Capacidade kg (2 peças)

D.523

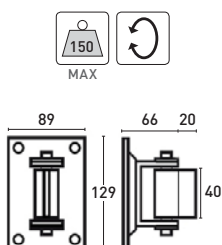

Dobradiça regulável com placa

REF.	ACB	Cap.	
D.523	FZ	150kg	10

Cap. = Capacidade kg (2 peças)

E.428-T

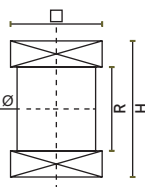

Eixo torneado para dobradiças

REF.	ACB	Ø	H	R	E	
E.428-T.30	FZ	30	52	32	35	10
E.428-T.35	FZ	35	57	37	40	6
E.428-T.40	FZ	40	62	42	50	6

Para aplicar com dobradiça D.428

P.480

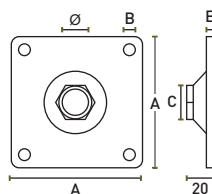

Placa para dobradiças reguláveis

REF.	ACB	Ø	A	B	C	E	
P.480.16	FZ	16	80	9	27	4	10
P.480.20	FZ	20	100	9	30	5	
P.480.24	FZ	24	120	11	36	6	



0.415.R

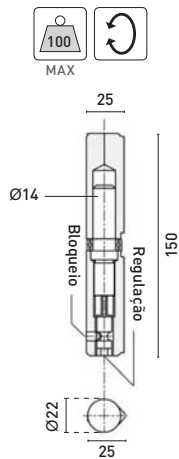

Olhal (dobradiça) para soldar regulável com anilhas de esferas

Olhal Ø22 em aço
Fiel interior fixo Ø14 em aço zincado
Anilha com rolamentos esferas em aço zincado

REF.	ACB	Cap.	
0.415.R	FP	100kg	12

kg - capacidade carga 2 dobradiças

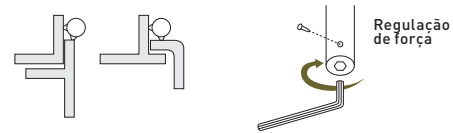

OM.415.M

NEW NOVO

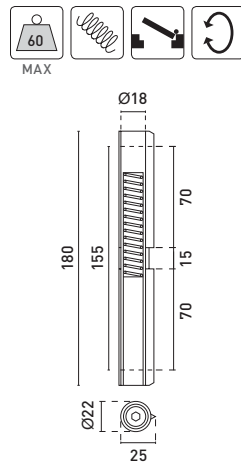

Olhal (dobradiça) para soldar regulável com mola

Olhal em aço + anilha em latão com mola
Fecha a porta automaticamente
Força de fecho regulável

REF.	ACB	Cap.	
OM.415.M	FP	60kg	12

kg - capacidade carga 2 dobradiças

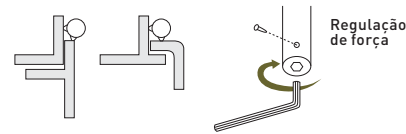

0.417.R

NEW NOVO



Img: Esq.

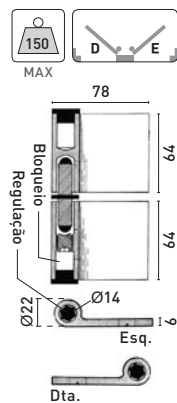

Olhal (dobradiça) com abas para soldar regulável

Anilha em borracha
Topos em nylon

REF.	ACB	Cap.	
0.417.R - Dta.	FP	150kg	6
0.417.R - Esq.	FP		

kg - capacidade carga 2 dobradiças

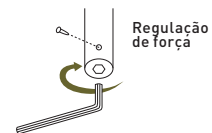

0.419

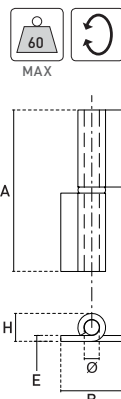

Olhal (dobradiça) com abas para soldar

Fiel amovível
Ambidextra [Dta./Esq.]

REF.	Cap.	A	Ø	B	E	H	
0.419.80	40kg	80	8	34	2	12	10
0.419.120	60kg	120	12	46	4	20	

kg - capacidade carga 2 dobradiças

FP - Aço Natural



0.819
0.819 - INOX

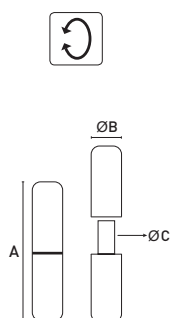

Olhal torneado para soldar

Fiel amovível

REF.	MED. (mm) AxBxC	
0.819-50x11x6	50x11x6	25
0.819-64x11x6	64x11x6	
0.819-76x14x8	76x14x8	
0.819-80x15x8	80x15x8	
0.819-90x18x9	90x18x9	
0.819-100x20x11	100x20x11	

FP - Aço Natural / IN - Inox Natural Aisi 304

0.820
0.820 - INOX

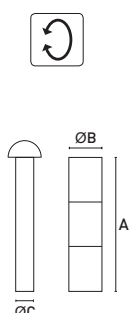

Olhal torneado para soldar

REF.	MED. (mm) AxBxC	
0.820-50x11x6	50x11x6	25
0.820-64x11x6	64x11x6	
0.820-76x14x8	76x14x8	
0.820-80x15x8	80x15x8	
0.820-90x18x9	90x18x9	
0.820-100x20x11	100x20x11	
0.820-120x20x11	120x20x11	16
0.820-125x25x14	125x25x14	
0.820-150x30x16	150x30x16	

FP - Aço Natural / IN - Inox Natural Aisi 304

0.822

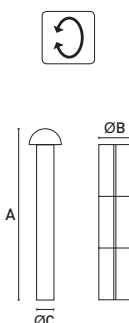

Olhal chapa enrolada para soldar

REF.	MED. (mm) AxBxC	
0.822-1/4	64x12x6.5	50
0.822-5/16	75x14x8	
0.822-3/8	87x17x10	
0.822-4/8	100x19x12.5	
0.822-5/8	120x32x15	25

FP - Aço Natural

R.489

**NEW
NOVO**

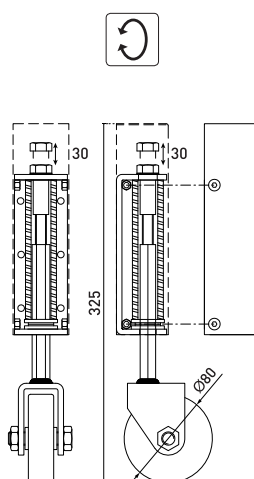

Roda de suporte com regulação

REF.	ACB	Medida (Regulação)	
R.489	FZ	30	2



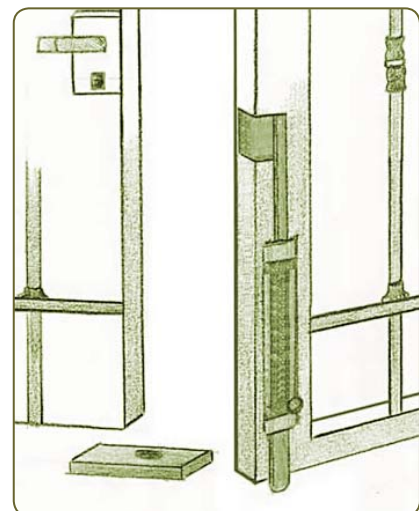
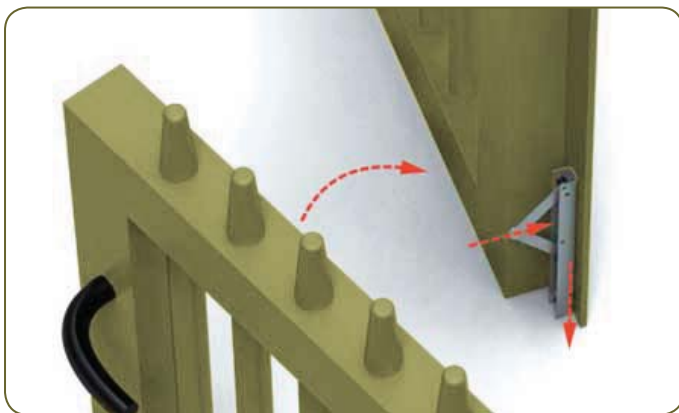
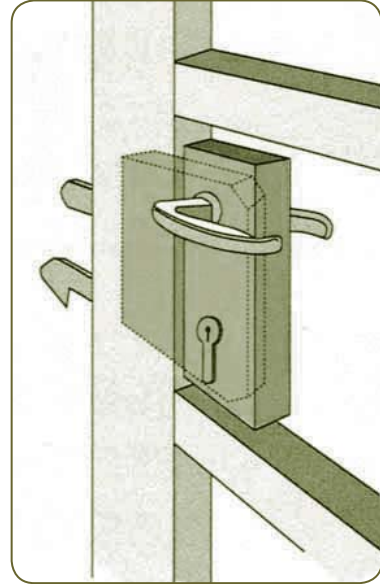



FERRAGENS SERRALHARIA FECHADURAS PARA PORTÕES



F.447.4.03

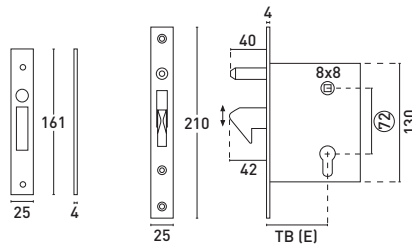
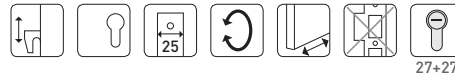

F.CT.447.A

F.447.4.03.50
F.447.4.03.65

F.CX.446.40

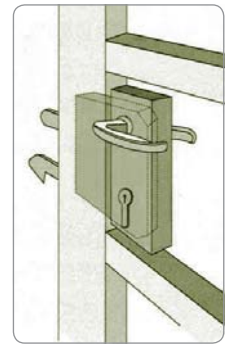

F.447P.4.03

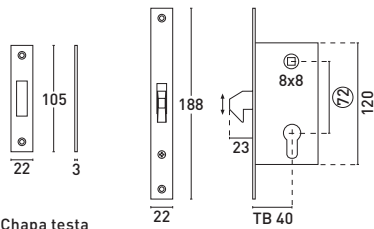
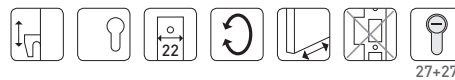

Chapa testa
incluída

F.447P.4.03.40

Fechaduras de gancho
para portões de correr

REF.	ACB	TB (E)	
F.447P.4.03.C1.40	FZ	40	1
F.447.4.03.C1.50	FZ	52	1
F.447.4.03.C1.65	FZ	65	1
F.CT.447.A	FZ	-	1
F.CX.446.40	FZ	-	1

Incluem cilindro perfil europeu

F.477.1.03

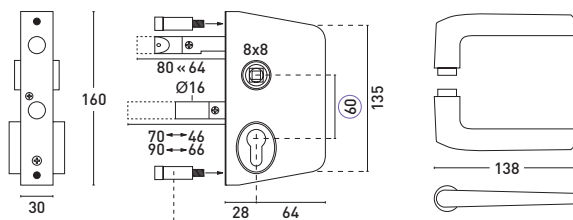

Fechadura trinco e língua O
reguláveis para portões
"Anti-corrosão" - Alumínio e Latão

REF.	ACB	
F.477.1.03	AN	1
F.CT.477.A	FZ	1

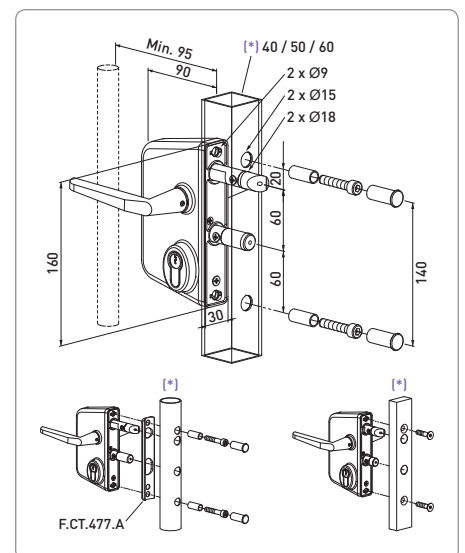
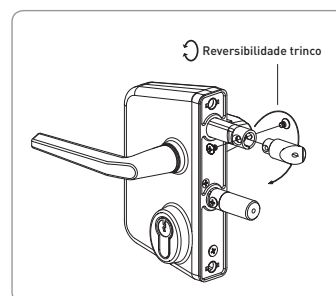



F.794.7.03

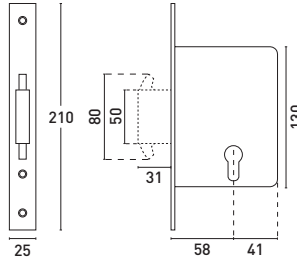
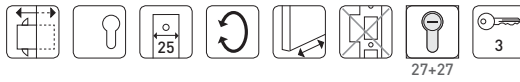

Fechadura com língua de garras

REF.	ACB	
F.794.7.03	FZ	1

Inclui cilindro perfil europeu

F.720.B

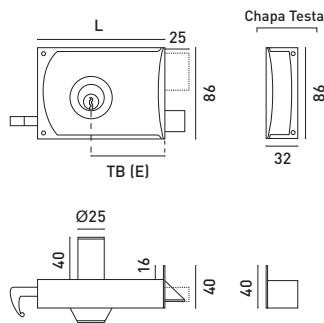

Fechadura sobrepor tipo Yall

REF.	ACB	L	TB	
F.720.Bx10 - Dta. / Esq.	*	100	53	1/30
F.720.Bx12 - Dta. / Esq.	*	120	65	

* Caixa em aço lacado castanho / Metais dourados

Caixa exterior: 30un.

F.771.3.03



22mm Frente: 22mm
15,5mm Espessura caixa: 5,5mm

Testa em INOX satinado



TB (E)	30	35
A	45	50

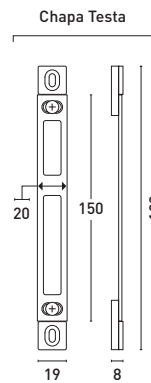

F.CT.1.AF
Chapa testa com afinação.
Não incluída.

Trinco reversível e regulável

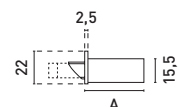
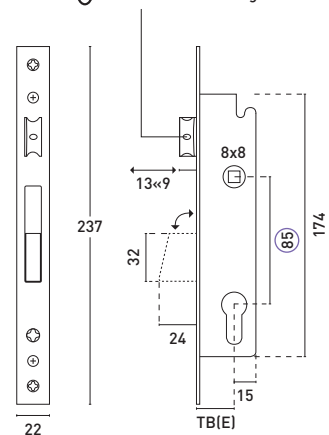

Mais Soluções em Fechaduras, consultar Catálogo FECHADURAS ou www.batista-gomes.pt



FX.164 - INOX

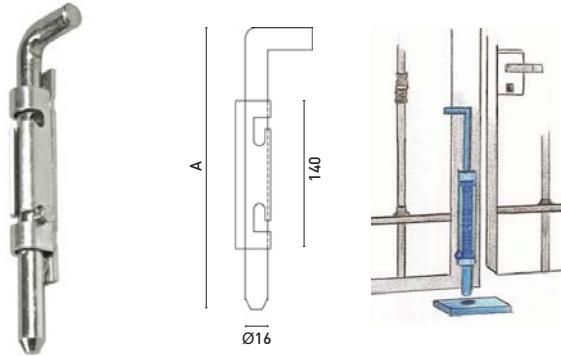

Fecho para portões - INOX

REF.	ACB	A	
FX.164x300	INOX	300	10

FX.165

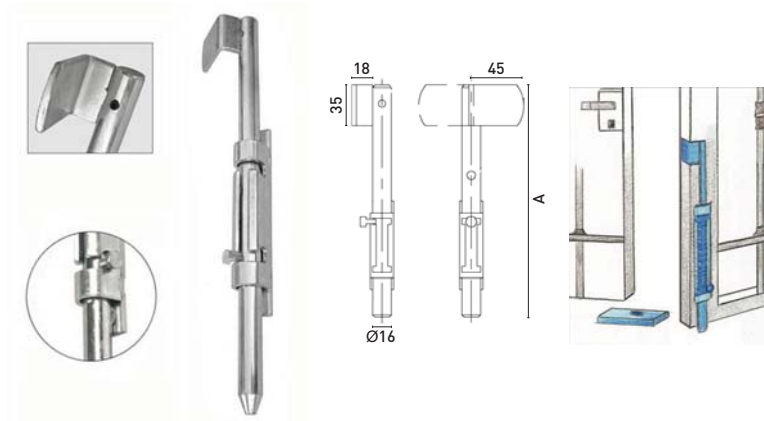

Fecho de segurança para portões

REF.	ACB	A	
FX.165x250	FZ	250	10
FX.165x300	FZ	300	
FX.165x500	FZ	500	

FX.166

FX.166 - INOX

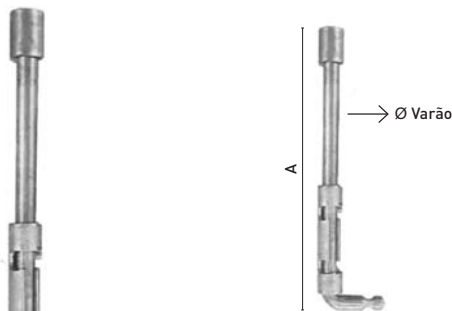

Polegadas = 25.01mm
Palmo = 220mm

As dimensões indicadas são aproximadas.

Fecho serralheiro

REF.	ACB	MED. VARÃO Ø	MED. A palmo/mm	
FX.166 - 5/16x3"	FP	5/16 (8mm)	*3 Pol. - 75	24
FX.166 - 5/16x1/2		5/16 (8mm)	1/2 - 110	
FX.166 - 5/16x3/4		5/16 (8mm)	3/4 - 165	
FX.166 - 5/16x1		5/16 (8mm)	1 - 220	
FX.166 - 3/8x1/2	FP	3/8 (10mm)	1/2 - 110	12
FX.166 - 3/8x3/4		3/8 (10mm)	3/4 - 165	
FX.166 - 3/8x1		3/8 (10mm)	1 - 220	
FX.166 - 3/8x1 1/2		3/8 (10mm)	1 1/2 - 330	
FX.166 - 3/8x2	FP	3/8 (10mm)	2 - 440	12
FX.166 - 4/8x1/2		4/8 (12mm)	1/2 - 110	
FX.166 - 4/8x3/4		4/8 (12mm)	3/4 - 165	
FX.166 - 4/8x1		4/8 (12mm)	1 - 220	
FX.166 - 4/8x1 1/2	FP	4/8 (12mm)	1 1/2 - 330	12
FX.166 - 4/8x2		4/8 (12mm)	2 - 440	
FX.166 - 4/8x3		4/8 (12mm)	3 - 660	
FX.166 - 5/8x1		5/8 (16mm)	1 - 200	
FX.166 - 5/8x1 1/2	FP	5/8 (16mm)	1 1/2 - 330	12
FX.166 - 5/8x2		5/8 (16mm)	2 - 440	
FX.166 - 5/8x3		5/8 (16mm)	3 - 660	
FX.166 - 5/16x3"	INOX	5/16 (8mm)	* 3 Pol. - 75	12
FX.166 - 3/8x3/4		3/8 (10mm)	3/4 - 165	12
FX.166 - 3/8x1		3/8 (10mm)	1 - 220	12
FX.166 - 4/8x1 1/2		4/8 (12mm)	1 1/2 - 330	
FX.166 - 4/8x2		4/8 (12mm)	2 - 440	

* Polegadas

FX.409 - INOX

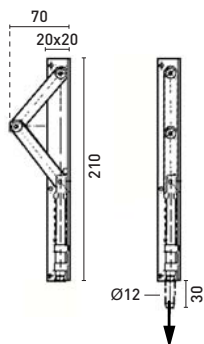

Fecho automático com mola - INOX

REF.	ACB	
FX.409	INOX	6

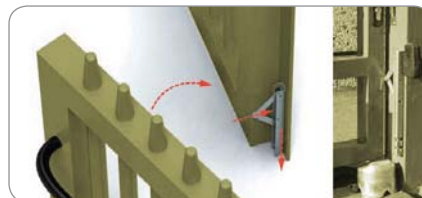

FX.418

**NEW
NOVO**

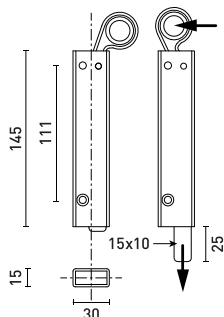





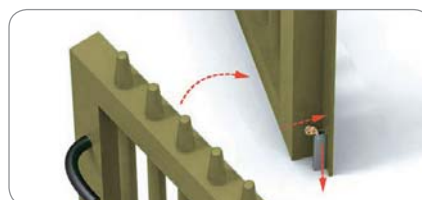

Fecho automático com mola

REF.	ACB	
FX.418	FZ	6







Caixa em aço zincado
Varão em latão ∇ 15x10







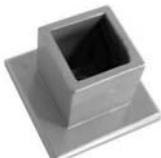



REF.		DIM.	ACB
	PG.6	115x75 Furo Ø16	<p>SEM ANODIZAÇÃO</p> <p>AN - Alumínio Natural (sem anodização)</p> <p>LACADO</p> <p>ALBr - Alumínio Lacado Branco ALPr - Alumínio Lacado Preto ALVd - Alumínio Lacado Verde ALCt - Alumínio Lacado Castanho AL - Alumínio Lacado Outros (indicar)</p>
	PG.9	110x60 Furo Ø16	
	PG.14	115x45 Furo Ø16	
	PG.60	91x41 Furo Ø16	
	PG.102	35x45 Furo Ø16	
	PG.113	25x38 Furo Ø16	
	PG.111	40x50 Furo Ø16	
	PG.114	80x45 Furo Ø20	

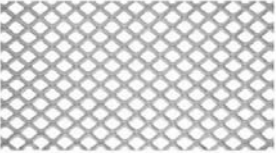

REF.		DIM.	ACB
	PG.115	45x45 Furo \varnothing 20	<p>SEM ANODIZAÇÃO</p> <p>AN - Alumínio Natural (sem anodização)</p> <p>LACADO</p> <p>ALBr - Alumínio Lacado Branco ALPr - Alumínio Lacado Preto ALVd - Alumínio Lacado Verde ALCt - Alumínio Lacado Castanho AL - Alumínio Lacado Outros (indicar)</p>
	PG.123	126x40 Furo \varnothing 16	
	PG.124	70x40 Furo \varnothing 16	
	PG.154	Altura: 60 Para tubo 30x30	
	PG.157	Para tubo 60x60	
	PG.158	Para tubo 65x65	
	PG.172	Para tubo 60x60	
	PG.173	Para tubo 65x65	
	PG.187	Para tubo 60x60	
	PG.188	Para tubo 65x65	



REF.	DIM.	ACB	
	PG.260 200x375	SEM ANODIZAÇÃO AN - Alumínio Natural (sem anodização) LACADO ALBr - Alumínio Lacado Branco ALPr - Alumínio Lacado Preto ALVd - Alumínio Lacado Verde ALCt - Alumínio Lacado Castanho AL - Alumínio Lacado Outros (indicar)	
	PG.260.G 260x465		
	PG.261 130x130		
	PG.303.850 Obs: Outros tamanhos - 370mm - 500mm - 600mm - 700mm Por consulta		850
	PG.403 510x1012		
	PG.411 825x500 Com parafusos		
	PG.411P 505x505 Com parafusos		
	PG.411E 825x235 Com parafusos		



DISCOS RÍGIDOS - Informações Técnicas

Norma Europeia EN 13.236

STANDARD

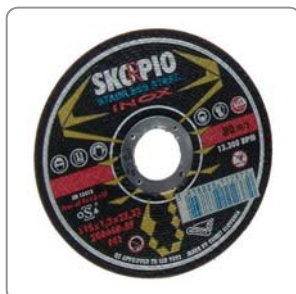

EXTRA



EXTRAPLUS

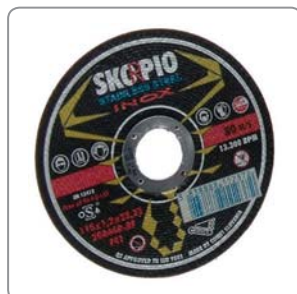

PRESCRIÇÕES DE MARCAÇÃO



- ① Marca
- ② Qualidade
- ③ Materiais a trabalhar
- ④ Velocidade periférica máxima
- ⑤ RPMs Máximo
- ⑥ Pictogramas de segurança
- ⑦ Membro da organização para segurança de abrasivos
- ⑧ Código de barras
- ⑨ Norma Europeia de segurança
- ⑩ Referência
- ⑪ Dimensões

Recomendações



Ter em atenção as recomendações de segurança



Usar máscara contra poeiras



Usar protecção para os ouvidos



Usar protecção para os olhos



Usar luvas

Mais informações: Consultar Catálogo específico



DISCOS DIAMANTADOS - Informações Técnicas

Norma Europeia EN 13.236

ECO + CUT



PROFI + CUT

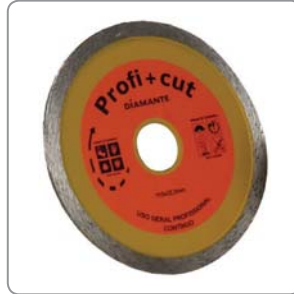

PREMIUM



PRESCRIÇÕES DE MARCAÇÃO



- ① Qualidade
- ② Materiais a trabalhar
- ③ Dimensões
- ④ Pictogramas de segurança

- Corte a húmido
- Corte a seco e a húmido
- Corte a seco

Recomendações



Ter em atenção as recomendações de segurança



Usar máscara contra poeiras



Usar protecção para os ouvidos



Usar protecção para os olhos



Usar luvas

Mais informações: Consultar Catálogo específico



DISCOS DE CORTE AÇO "STANDARD" (SKORPIO)

A 30 T / A 30 S



Aplicações:

- Ligas de aço
- Aços carbono
- Metais

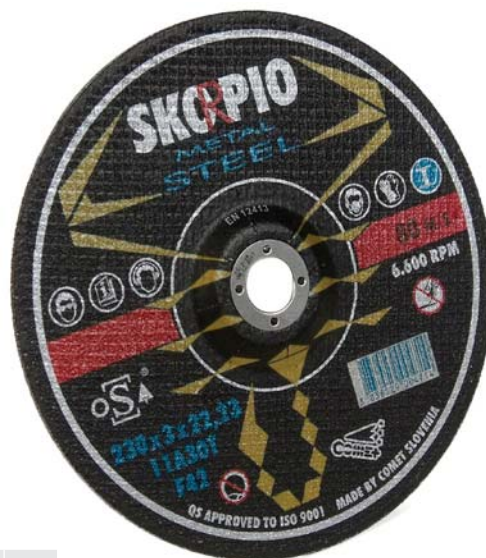

REF.	DIMENSÕES (mm) Ø x E x F	FORMA	R.P.M.	
D.A.30.T	115x2,5x22,23	F42	13.300	25
D.A.30.T	125x2,5x22,23	F42	12.250	
D.A.30.T	178x3,0x22,23	F42	8.500	
D.A.30.T	230x3,0x22,23	F42	6.650	
D.A.30.T	300x3,0x25,40	F41	5.100	
D.A.30.T	350x3,5x25,40	F41	4.400	

Ø - Diâmetro / E - Espessura / F - Furo

DISCOS DE REBARBAR AÇO "STANDARD" (SKORPIO)

A 24 S (A 24 S4)



Aplicações:

- Ligas de aço
- Aços carbono
- Soldaduras
- Metais



REF.	DIMENSÕES (mm) Ø x E x F	FORMA	R.P.M.	
D.A.24.S4	115x6x22,23	F27	13.300	10
D.A.24.S4	125x6x22,23	F27	12.250	
D.A.24.S4	178x6x22,23	F27	8.500	
D.A.24.S4	230x6x22,23	F27	6.650	

Ø - Diâmetro / E - Espessura / F - Furo



DISCOS DE CORTE INOX "STANDARD" (SKORPIO)

20 A 46 R / 20 A 60R



Aplicações:

- Aço Inox
- Ligas de aço
- Aços Carbono
- Soldaduras
- Metais



REF.	DIMENSÕES (mm) Ø x E x F	FORMA	R.P.M.	
D.20.A.46.R	115x1x22,23	F41	13.300	50
D.20.A.46.R	125x1x22,23	F41	12.250	
D.20.A.46.R	178x1,6x22,23	F41	8.500	
D.20.A.46.R	230x1,9x22,23	F41	6.650	
D.20.A.46.R	178x1,6x22,23	F42	8.500	25
D.20.A.46.R	230x1,9x22,23	F42	6.650	

Ø - Diâmetro / E - Espessura / F - Furo

DISCOS DE CORTE PEDRA "STANDARD" (SKORPIO)

C 30 S



Aplicações:

- Pedras naturais
- Pedras artificiais
- Betão
- Cerâmica
- Alvenaria



REF.	DIMENSÕES (mm) Ø x E x F	FORMA	R.P.M.	
D.C.30.S	115x3x22,23	F42	13.300	25
D.C.30.S	125x3x22,23	F42	12.500	
D.C.30.S	178x3x22,23	F42	8.500	
D.C.30.S	230x3x22,23	F42	6.650	

Ø - Diâmetro / E - Espessura / F - Furo





DISCOS DIAMANTADOS MÁQUINAS PORTÁTEIS ECO+cut

🚰+🔪 Corte a seco e a húmido

Aplicações:

- 1 - Universal / Betão (dureza média)
- 2 - Cerâmica
 - Azulejos
 - Telas
 - Mármore



		REF.	DIMENSÕES (mm) Ø x E x F	R.P.M.	📦
 1	SEGMENTADO	D.DE.1S	115x2,0x7,0x22,23	13.300	1
		D.DE.1S	125x2,0x7,0x22,23	12.250	
		D.DE.1S	230x2,6x7,5x22,23	6.650	
 1	TURBO	D.DE.1T	115x2,5x7,0x22,23	13.300	1
		D.DE.1T	125x2,5x7,0x22,23	12.250	
		D.DE.1T	230x3,2x7,0x22,23	6.650	
 2	CONTÍNUO	D.DE.2C	115x2,0x5,0x22,23	13.300	1
		D.DE.2C	125x2,0x5,0x22,23	12.250	
		D.DE.2C	150x2,2x5,0x22,23	10.200	
		D.DE.2C	180x2,2x5,0x22,23	8.500	
		D.DE.2C	230x2,4x5,0x22,23	6.650	

Ø - Diâmetro / E - Espessura / F - Furo



DISCOS DIAMANTADOS MÁQUINAS PORTÁTEIS PREMIUM

🚰+🔪 Corte a seco e a húmido

Aplicações:

- 1 - Universal
 - Materiais duros
- 2 - Granito
 - Pedra natural
 - Materiais duros
- 3 - Betão
 - Granito
 - Pedra natural



		REF.	DIMENSÕES (mm) Ø x E x F	R.P.M.	📦
 1	SEGMENTADO	D.DP.1S	115x2,2x10,0x22,23	13.300	1
		D.DP.1S	230x2,8x10,0x22,23	6.650	
 2	SEGMENTADO	D.DP.2S	115x2,4x10,0x22,23	13.300	1
		D.DP.2S	230x2,6x10,0x22,23	6.650	
 3	TURBO	D.DP.3T	115x2,0x12,0x22,23	13.300	1
		D.DP.3T	230x2,4x12,0x22,23	6.650	

Ø - Diâmetro / E - Espessura / F - Furo



DISCOS DIAMANTADOS EXTRAFINOS

💧 + ✂️ Corte a seco e a húmido

Aplicações:

- 1 - ECO+CUT
- 2 - PROFI+CUT
 - Granito
 - Mármore
 - Cerâmica
 - Azulejos
 - Telha



💧 + ✂️

1



TURBO

REF.	DIMENSÕES (mm) Ø x E x F	R.P.M.	
D.DEF.E1T	115x1,2x7,0x22,23	13.300	1
D.DEF.E1T	125x1,2x7,0x22,23	12.250	
D.DEF.P2T	115x1,2x7,0x22,23	13.300	1
D.DEF.P2T	125x1,2x7,0x22,23	12.250	
D.DEF.P2T	150x1,5x7,0x22,23	10.200	
D.DEF.P2T	180x1,7x7,0x22,23	8.500	
D.DEF.P2T	230x1,9x7,0x22,23	6.650	
D.DEF.P2T	230x1,9x7,0x22,23	6.650	

💧 + ✂️

2



TURBO

Ø - Diâmetro / E - Espessura / F - Furo

soluções em
ferragens
para arquitectura

hardware
solutions
for architecture



Batista Gomes, Lda.
Zona Industrial Sul
Variante Recardães-Barrô, 1541
P.O.Box 55
3754-001 Barrô-Águeda
Portugal

Tel: +351 234 612 520
Fax: +351 234 625 580
E-mail: geral@batista-gomes.pt



BATISTA-GOMES.PT

handlie.com