



# G



---

**PUXADORES DE  
MÓVEL /**  
FURNITURE  
KNOBS /  
POMOS DE  
MUEBLE.

---

## PUXADORES DE MÓVEL / FURNITURE KNOBS / POMOS DE MUEBLE.

### IN.22.130

EN 1.4301-Satinado/Satin/Satin

**Puxador de móvel/**

Furniture knob /  
Pomo de mueble /

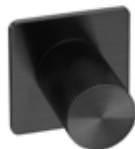
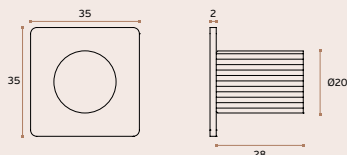

### IN.22.130.TB

Material: EN 1.4301 +  
**TITANIUM - Black**

Satinado / Satin / Satin

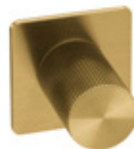

### IN.22.130.TG

Material: EN 1.4301 +  
**TITANIUM - Gold**

Satinado / Satin / Satin

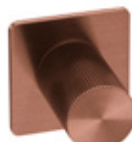

### IN.22.130.TCO

Material: EN 1.4301 +  
**TITANIUM - Copper**

Satinado / Satin / Satin

### IN.22.131

EN 1.4301-Satinado/Satin/Satin

**Puxador de móvel/**

Furniture knob /  
Pomo de mueble /

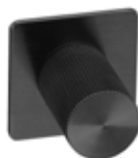
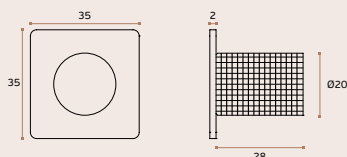
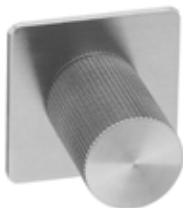

### IN.22.131.TB

Material: EN 1.4301 +  
**TITANIUM - Black**

Satinado / Satin / Satin

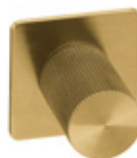

### IN.22.131.TG

Material: EN 1.4301 +  
**TITANIUM - Gold**

Satinado / Satin / Satin

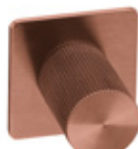

### IN.22.131.TCO

Material: EN 1.4301 +  
**TITANIUM - Copper**

Satinado / Satin / Satin

### IN.22.132

EN 1.4301-Satinado/Satin/Satin  
Puxador de móvel/  
Furniture knob /  
Pomo de mueble /

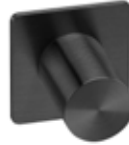
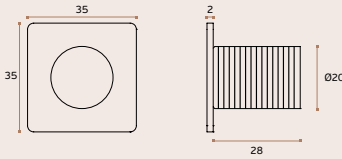

IN.22.132.TB  
Material: EN 1.4301 +  
TITANIUM - Black  
Satinado / Satin / Satin



IN.22.132.TG  
Material: EN 1.4301 +  
TITANIUM - Gold  
Satinado / Satin / Satin



IN.22.132.TCO  
Material: EN 1.4301 +  
TITANIUM - Copper  
Satinado / Satin / Satin

### IN.22.133

EN 1.4301-Satinado/Satin/Satin  
Puxador de móvel/  
Furniture knob /  
Pomo de mueble /

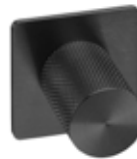
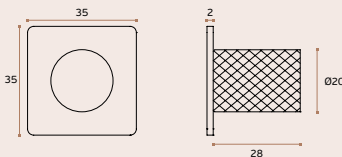

IN.22.133.TB  
Material: EN 1.4301 +  
TITANIUM - Black  
Satinado / Satin / Satin

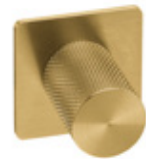

IN.22.133.TG  
Material: EN 1.4301 +  
TITANIUM - Gold  
Satinado / Satin / Satin

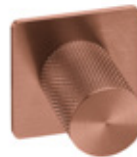

IN.22.133.TCO  
Material: EN 1.4301 +  
TITANIUM - Copper  
Satinado / Satin / Satin

G/1014

Ferragens de Mobiliário /  
Furniture Hardware /  
Herrajes para Mueble.

www.jnf.pt

# PUXADORES DE MÓVEL / FURNITURE KNOBS / POMOS DE MUEBLE.



# PUXADORES DE MÓVEL / FURNITURE KNOBS / POMOS DE MUEBLE.

## IN.22.103

EN 1.4301-Satinado/Satin/Satin  
**Puxador de móvel/**  
Furniture knob /  
Pomo de mueble /

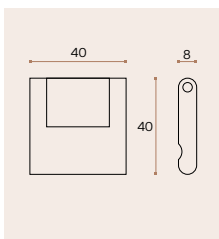

## IN.22.100

EN 1.4301-Satinado/Satin/Satin  
**Puxador de móvel/**  
Furniture knob /  
Pomo de mueble /

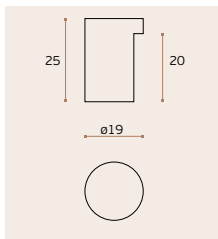

## IN.22.101

EN 1.4301-Satinado/Satin/Satin  
**Puxador de móvel/**  
Furniture knob /  
Pomo de mueble /

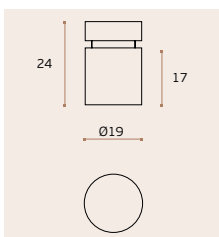

## IN.22.102

EN 1.4301-Satinado/Satin/Satin  
**Puxador de móvel/**  
Furniture knob /  
Pomo de mueble /

	A	B
IN.22.102.10	Ø10	20
IN.22.102.14	Ø14	20
IN.22.102.19	Ø19	25
IN.22.102.25	Ø25	28

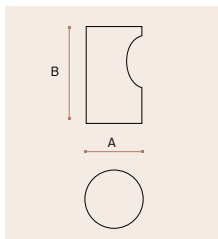

### IN.22.107

EN 1.4301-Satinado/Satin/Satin  
**Puxador de móvel/**  
Furniture knob /  
Pomo de mueble /

	A
IN.22.107.10	Ø10
IN.22.107.14	Ø14

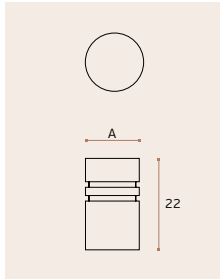

### IN.22.108

EN 1.4301-Satinado/Satin/Satin  
**Puxador de móvel/**  
Furniture knob /  
Pomo de mueble /

	A	B
IN.22.108.15	Ø15	20
IN.22.108.19	Ø19	25

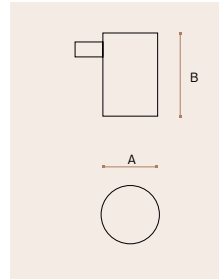

### IN.22.110

EN 1.4301-Satinado/Satin/Satin  
**Puxador de móvel/**  
Furniture knob /  
Pomo de mueble /

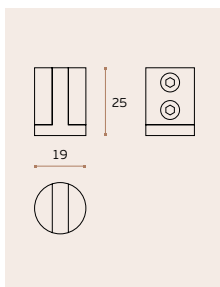

### IN.22.111

EN 1.4301-Satinado/Satin/Satin  
**Puxador de móvel/**  
Furniture knob /  
Pomo de mueble /

	A	B
IN.22.111.15	Ø15	20
IN.22.111.20	Ø20	25
IN.22.111.25	Ø25	33
IN.22.111.30	Ø30	35

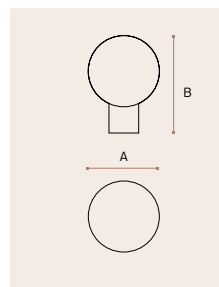



# PUXADORES DE MÓVEL / FURNITURE KNOBS / POMOS DE MUEBLE.

## IN.22.112

EN 1.4301-Satinado/Satin/Satin

**Puxador de móvel/**

Furniture knob /

Pomo de mueble /

	A	B
IN.22.112.15	Ø15	15
IN.22.112.20	Ø20	18
IN.22.112.25	Ø25	22

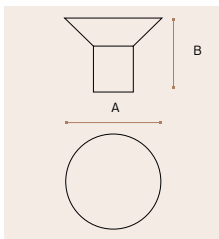

## IN.22.113

EN 1.4301-Satinado/Satin/Satin

**Puxador de móvel/**

Furniture knob /

Pomo de mueble /

	A	B
IN.22.113.12	Ø12	20
IN.22.113.14	Ø14	22
IN.22.113.18	Ø18	24

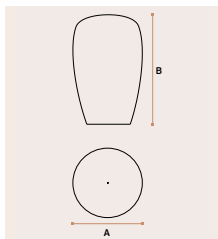

## IN.22.115

EN 1.4301-Satinado/Satin/Satin

**Puxador de móvel/**

Furniture knob /

Pomo de mueble /

	A
IN.22.115.10	Ø10
IN.22.115.14	Ø14

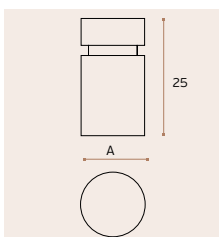

## IN.22.116

EN 1.4301-Satinado/Satin/Satin

**Puxador de móvel/**

Furniture knob /

Pomo de mueble /

	A	B
IN.22.116.12	Ø12	22
IN.22.116.18	Ø18	27

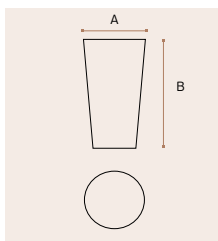

### IN.22.185

EN 1.4301-Satinado/Satin/Satin  
**Puxador de móvel/**  
Furniture knob /  
Pomo de mueble /

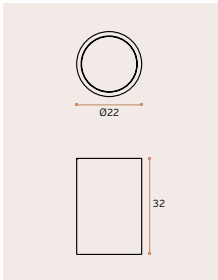

### IN.22.117

EN 1.4301-Satinado/Satin/Satin  
**Puxador de móvel/**  
Furniture knob /  
Pomo de mueble /

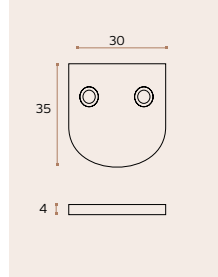

### IN.22.118 QUADRO

EN 1.4301-Satinado/Satin/Satin  
**Puxador de móvel/**  
Furniture knob /  
Pomo de mueble /  
Design: JNF

	A	B
IN.22.118.12	12X12	20
IN.22.118.19	19X19	25

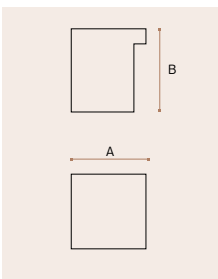

### IN.22.124 ERGOform

EN 1.4301-Satinado/Satin/Satin  
**Puxador de móvel/**  
Furniture knob /  
Pomo de mueble /

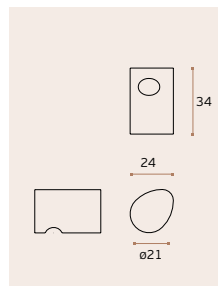

## PUXADORES DE MÓVEL / FURNITURE KNOBS / POMOS DE MUEBLE.

### AM.22.010 Touch It

EN 1.4301-Satinado/Satin/Satin

**Puxador de móvel/**

Furniture knob /

Pomo de mueble /

**Design:** Ana Moreira

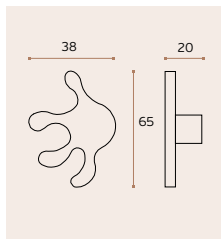

### MV.22.010 Tubyk

EN 1.4301-Satinado/Satin/Satin

**Puxador de móvel/**

Furniture knob /

Pomo de mueble /

**Design:** Miguel Vasconcelos

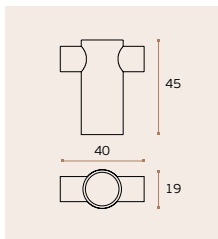

### SR.22.004.N Skin

EN 1.4301-Satinado/Satin/Satin

**Puxador de móvel/**

Furniture knob /

Pomo de mueble /

**Design:** Susana Ribeiro

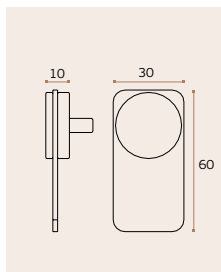

### SR.22.005.N Skin

EN 1.4301-Satinado/Satin/Satin

**Puxador de móvel/**

Furniture knob /

Pomo de mueble /

**Design:** Susana Ribeiro

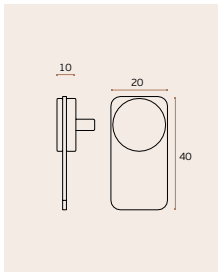

**SR.22.004.C Skin**  
EN 1.4301-Satinado/Satin/Satin  
**Puxador de móvel/**  
Furniture knob /  
Pomo de mueble /  
**Design:** Susana Ribeiro

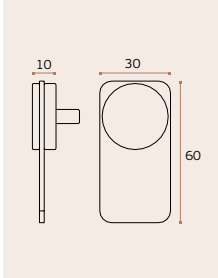

**SR.22.005.C Skin**  
EN 1.4301-Satinado/Satin/Satin  
**Puxador de móvel/**  
Furniture knob /  
Pomo de mueble /  
**Design:** Susana Ribeiro

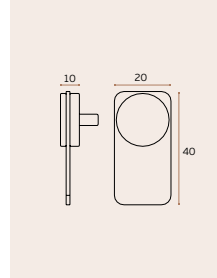

**SR.22.004.B Skin**  
EN 1.4301-Satinado/Satin/Satin  
**Puxador de móvel/**  
Furniture knob /  
Pomo de mueble /  
**Design:** Susana Ribeiro

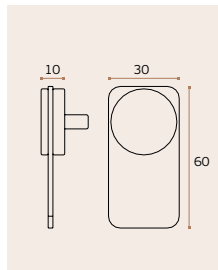

**SR.22.005.B Skin**  
EN 1.4301-Satinado/Satin/Satin  
**Puxador de móvel/**  
Furniture knob /  
Pomo de mueble /  
**Design:** Susana Ribeiro

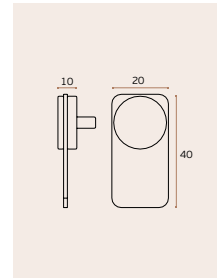

## PUXADORES DE MÓVEL / FURNITURE KNOBS / POMOS DE MUEBLE.

### CF.22.010 Informal

EN 1.4301-Satinado/Satin/Satin

**Puxador de móvel/**

Furniture knob /

Pomo de mueble /

**Design:** Catarina Fernandes

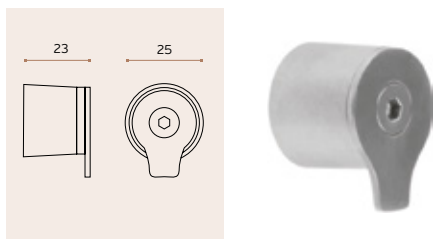

### MM.22.003 Pega

EN 1.4301-Satinado/Satin/Satin

**Puxador de móvel/**

Furniture knob /

Pomo de mueble /

**Design:** Mónica Moreira

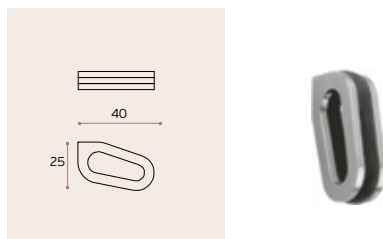

### MM.22.004 Pega

EN 1.4301-Satinado/Satin/Satin

**Puxador de móvel/**

Furniture knob /

Pomo de mueble /

**Design:** Mónica Moreira

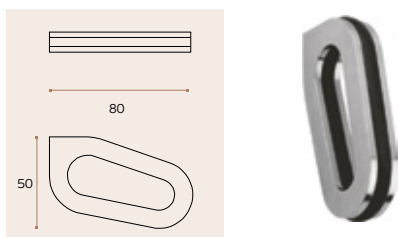

### IN.22.211

EN 1.4301-Satinado/Satin/Satin

**Puxador de móvel/**

Furniture knob /

Pomo de mueble /

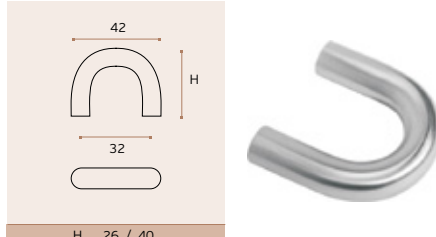

**IN.22.152.14** STOUT

EN 1.4301

Satinado / Satin / Satin

Puxador de móvel / Furniture knob /  
Tirador de mueble

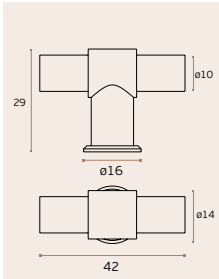

**IN.22.152.16** STOUT

EN 1.4301

Satinado / Satin / Satin

Puxador de móvel / Furniture knob /  
Tirador de mueble

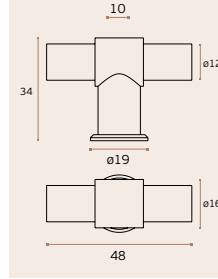

**IN.22.217**

EN 1.4301-Satinado/Satin/Satin

Puxador de móvel/

Furniture knob /  
Pomo de mueble /

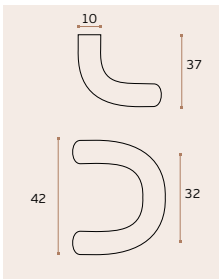

**IN.22.125.18** **IN.22.125.20** Train

EN 1.4301-Satinado/Satin/Satin

Puxador de móvel/

Furniture knob /  
Pomo de mueble /

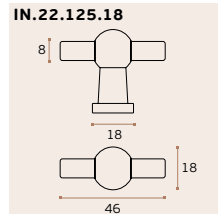
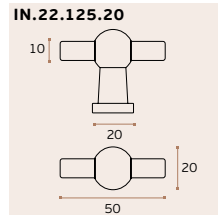

---

# ASAS DE MÓVEL / FURNITURE HANDLES / TIRADORES DE MUEBLE.

---



**IN.07.287.14**

**Material: EN 1.4301**

Satinado / Satin / Satin

**Asa de porta.** / Door handle /  
Manillon de puerta.

A	B
250	264
300	314
600	614

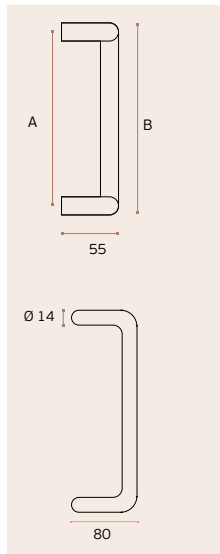

**IN.07.287.14.A**

**Material: EN 1.4301**

Satinado / Satin / Satin

**Asa de porta.** / Door handle /  
Manillon de puerta.

A	B
250	264
300	314
600	614

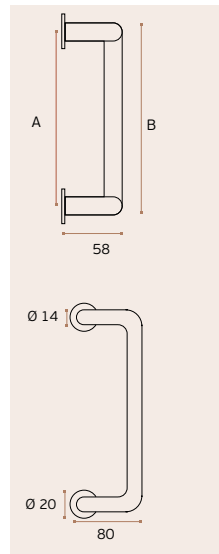



# ASAS DE MÓVEL / FURNITURE HANDLES / TIRADORES DE MUEBLE.

## IN.22.200 Quadro

EN 1.4301-Satinado/Satin/Satin

Asa de móvel/ Furniture handle / Tirador de mueble /

Ø	C.C.	L	H
8x8	96	104	35
8x8	128	136	35
8x8	160	168	35
8x8	192	200	35
8x8	224	232	35
10x10	32	42	35
10x10	96	106	35
10x10	128	138	35
10x10	160	170	35
10x10	224	234	35
10x10	320	330	35
12x12	128	140	35
12x12	160	172	35
12x12	224	236	35
12x12	320	332	35
12x12	480	492	35
12x12	704	716	35
16x16	224	240	40
16x16	384	400	40
16x16	480	496	40
16x16	704	720	40

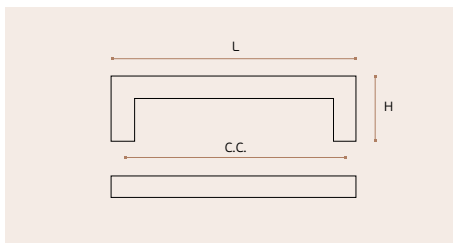

## IN.22.218

EN 1.4301-Satinado/Satin/Satin

Asa de móvel/  
Furniture handle /  
Tirador de mueble /

Ø	C.C.	L	H
20x6	128	134	30
20x6	160	166	30
20x6	192	198	30
20x6	224	230	30
20x6	320	326	30

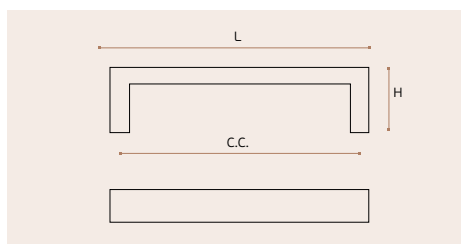



## ASAS DE MÓVEL / FURNITURE HANDLES / TIRADORES DE MUEBLE.

**IN.22.225** Train  
EN 1.4301-Satinado/Satin/Satin  
**Asa de móvel /**  
Furniture handle /  
Tirador de mueble /



Ø	C.C.	L	H
18	96	142	8
18	128	174	8
18	160	206	8
20	96	142	10
20	128	174	10
20	160	206	10

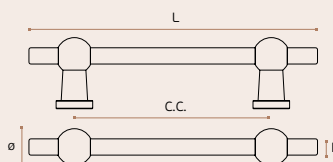

**IN.22.202**  
EN 1.4301-Satinado/Satin/Satin  
**Asa de móvel /**  
Furniture handle /  
Tirador de mueble /



Ø	C.C.	L	H
8	64	72	35
8	96	104	35
8	128	136	35
8	160	168	35
8	224	232	35
10	96	106	35
10	128	138	35
10	224	234	35
10	320	330	35
10	512	522	40

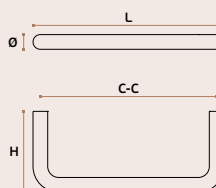

### IN.22.201

EN 1.4301-Satinado/Satin/Satin

Asa de móvel/  
Furniture handle /  
Tirador de mueble /



Ø	C.C.	L	H
10	96	110	30
10	128	150	30
10	224	260	30
10	320	370	30

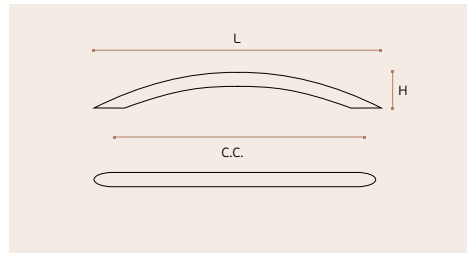

### IN.22.204

EN 1.4301-Satinado/Satin/Satin

Asa de móvel/  
Furniture handle /  
Tirador de mueble /



Ø	C.C.	L	H
10	96	106	35
10	128	138	35
10	224	234	35
10	320	330	35
16	224	240	40
16	320	336	40
16	384	400	40
16	448	464	40

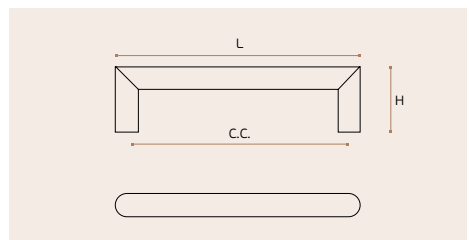

# ASAS DE MÓVEL / FURNITURE HANDLES /TIRADORES DE MUEBLE.

**IN.22.209**

EN 1.4301-Satinado/Satin/Satin

Asa de móvel/  
Furniture handle /  
Tirador de mueble /

Ø	C.C.	L	H
10	96	136	31
10	128	168	31
10	160	200	31
10	192	232	31
10	224	264	31
10	288	328	31
10	320	360	31
10	352	392	31
10	384	424	31
10	448	488	31
10	480	520	31
10	544	584	31
10	640	680	31
10	736	776	31
12	96	156	31
12	128	188	31
12	160	220	31
12	192	252	31
12	224	284	31
12	288	348	31
12	320	380	31
12	352	412	31
12	384	444	31
12	448	508	31
12	480	540	31
12	544	604	31
12	640	700	31
12	736	796	31

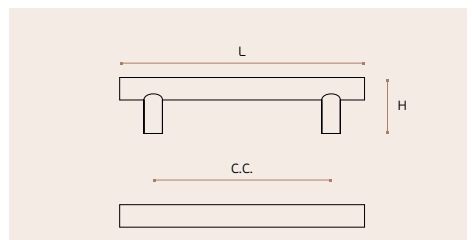

# ASAS DE MÓVEL / FURNITURE HANDLES / TIRADORES DE MUEBLE.

## IN.22.208

EN 1.4301-Satinado/Satin/Satin

Asa de móvel /

Furniture handle /  
Tirador de mueble /

∅	C.C.	L	H
10x10	192	202	30
10x10	224	234	30
10x10	320	330	30
10x10	512	522	30

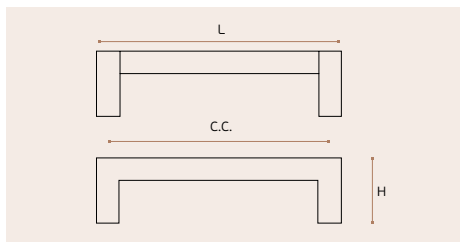

## IN.22.210

EN 1.4301-Satinado/Satin/Satin

Asa de móvel /

Furniture handle /  
Tirador de mueble /

∅	C.C.	L	H
10	96	130	30
10	128	160	30
10	160	180	30

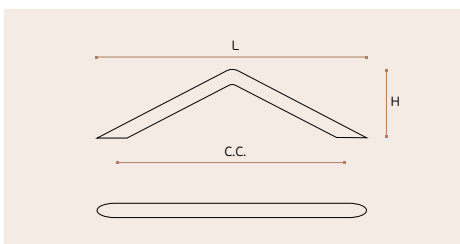

### IN.22.212

EN 1.4301-Satinado/Satin/Satin

**Asa de móvel/**

Furniture handle /  
Tirador de mueble /

Ø	C.C.	L	H
8+12	96	110	32
8+12	128	145	32

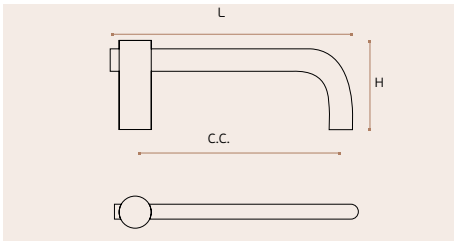

### IN.22.214

EN 1.4301-Satinado/Satin/Satin

**Asa de móvel/**

Furniture handle /  
Tirador de mueble /

Ø	C.C.	L	H
10X10	128	152	30
10X10	160	188	30
10X10	224	261	30
10X10	320	380	30

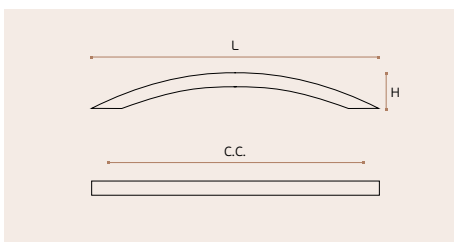



## ASAS DE MÓVEL / FURNITURE HANDLES / TIRADORES DE MUEBLE.

### IN.22.215

EN 1.4301-Satinado/Satin/Satin

Asa de móvel/  
Furniture handle /  
Tirador de mueble /

Furniture handle /  
Tirador de mueble /

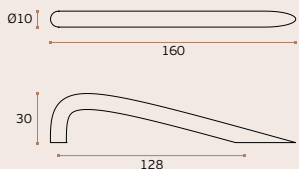

### IN.22.305

EN 1.4301-Satinado/Satin/Satin

Asa de móvel/  
Furniture handle /  
Tirador de mueble /

Furniture handle /  
Tirador de mueble /

C.C.	L
200	224
224	244
288	308
384	404

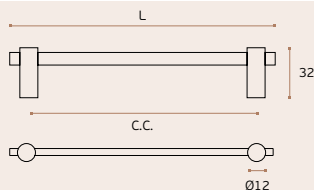

### IN.22.318

EN 1.4301-Satinado/Satin/Satin

Asa de móvel/

Furniture handle /

Tirador de mueble /

C.C.	L	H
224	246	30
288	210	30
384	406	30

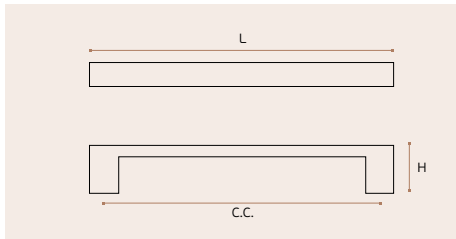

### IN.22.820

EN 1.4301-Satinado/Satin/Satin

Asa de móvel/

Furniture handle /

Tirador de mueble /

C.C.	L	H
128	152	37
160	184	37
192	216	37
224	248	37
320	344	37
400	424	37
448	472	37
592	616	37
688	712	37
800	824	37

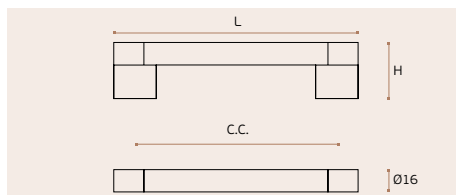

# ASAS DE MÓVEL / FURNITURE HANDLES / TIRADORES DE MUEBLE.

## IN.22.224

EN 1.4301-Satinado/Satin/Satin

Asa de móvel /

Furniture handle /

Tirador de mueble /

∅	C.C.	L	H
20x10	160	170	40
20x10	224	234	40
20x10	320	330	40
20x10	480	490	40
20x10	704	714	40

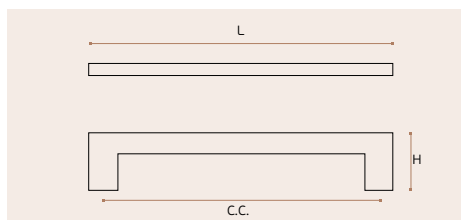

## IN.22.230

EN 1.4301-Satinado/Satin/Satin

Asa de móvel /

Furniture handle /

Tirador de mueble /

∅	C.C.	L	H
10x20	160	170	35
10x20	192	202	35
10x20	224	234	35
10x20	320	330	35
10x20	384	394	35
10x20	608	618	35
10x20	800	810	35

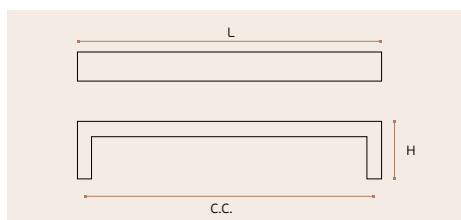



**IN.22.223 ERGOform**  
EN 1.4301-Satinado/Satin/Satin  
**Asa de móvel/**  
Furniture handle /  
Tirador de mueble /

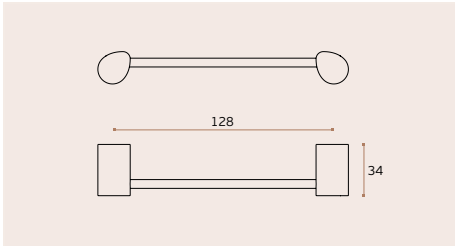

**IN.22.280 Soft**  
EN 1.4301-Satinado/Satin/Satin  
**Asa de móvel/**  
Furniture handle /  
Tirador de mueble /

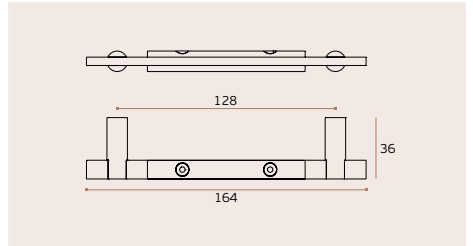

NEW

**IN.22.119**  
EN 1.4301-Satinado/Satin/Satin  
**Asa de móvel/**  
Furniture handle /  
Tirador de mueble.

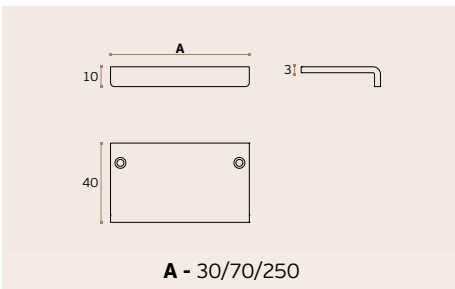

# CONCHAS / FLUSH HANDLES / CAZOLETAS.

## IN.16.317

EN 1.4301

Satinado/Satin/Satin

**Concha com puxador retráctil /**  
Flush Handle with with retractable handle/  
Cazoleta con manilla retráctil.

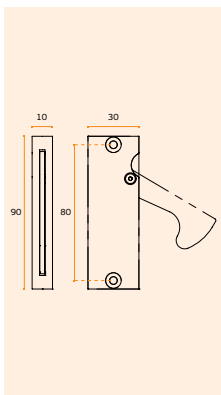

## IN.16.317.R

EN 1.4301

Satinado/Satin/Satin

**Concha com puxador retráctil /**  
Flush Handle with with retractable handle/  
Cazoleta con manilla retráctil.

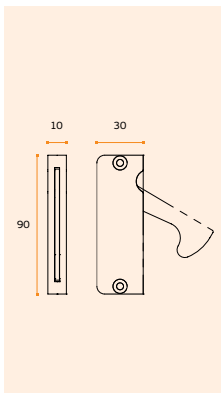



## CONCHAS / FLUSH HANDLES / CAZOLETAS.



### IN.16.103

EN 1.4301-Satinado/Satin/Satin

**Concha de embutir./**

Concealed flush handle./

Cazoleta de embutir. /

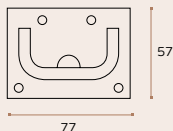

### IN.16.104

EN 1.4301-Satinado/Satin/Satin

**Concha de embutir./**

Concealed flush handle./

Cazoleta de embutir. /

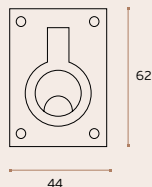

### IN.16.105

EN 1.4301-Satinado/Satin/Satin

**Concha de embutir./**

Concealed flush handle./

Cazoleta de embutir. /

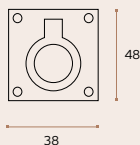

NEW

### IN.16.106

EN 1.4301-Satinado/Satin/Satin

**Concha de embutir./**

Concealed flush handle./

Cazoleta de embutir. /

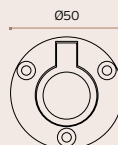



NEW

**IN.16.107**

EN 1.4301-Satinado/Satin/Satin  
**Concha de embutir com mola./**  
Concealed flush handle with spring./  
Cazoleta de embutir con muelle. /

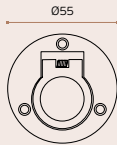

NEW

**IN.16.108**

EN 1.4301-Satinado/Satin/Satin  
**Concha de embutir com mola./**  
Concealed flush handle with spring./  
Cazoleta de embutir con muelle. /

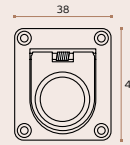

NEW

**IN.16.109**

EN 1.4301-Satinado/Satin/Satin  
**Concha de embutir com mola./**  
Concealed flush handle with spring./  
Cazoleta de embutir con muelle. /

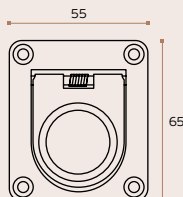

NEW

**IN.16.110**

EN 1.4301-Satinado/Satin/Satin  
**Concha de embutir com mola./**  
Concealed flush handle with spring./  
Cazoleta de embutir con muelle. /

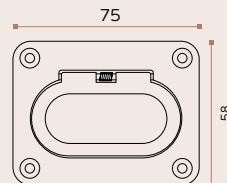



# CONCHAS / FLUSH HANDLES / CAZOLETAS.

## IN.16.223

EN 1.4301-Satinado/Satin/Satin

Concha de embutir./

Concealed flush handle./

Cazoleta de embutir. /

A	B	C	D	E
50X50	26X26	Ø40	10	2
70X70	40X40	Ø60	14	2

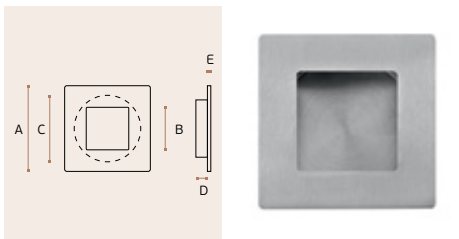

## IN.16.224

EN 1.4301-Satinado/Satin/Satin

Concha de embutir./

Concealed flush handle./

Cazoleta de embutir. /

A	B	C	D	E
70X70	40X25	Ø60	14	2
110X110	68X34	Ø102	14	2

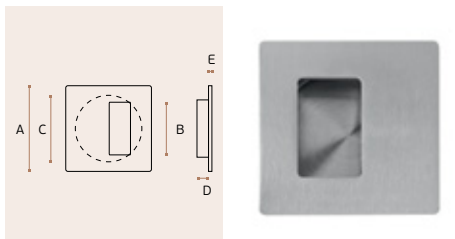

## IN.16.225

EN 1.4301-Satinado/Satin/Satin

Concha de embutir./

Concealed flush handle./

Cazoleta de embutir. /

A	B	C
Ø30	Ø25	10
Ø40	Ø35	10
Ø50	Ø40	10
Ø70	Ø60	14
Ø110	Ø102	14

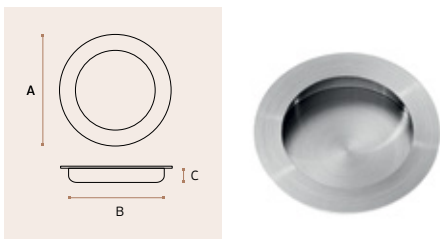

**IN.16.233**

EN 1.4301-Satinado/Satin/Satin  
**Concha de embutir./**  
Concealed flush handle./  
Cazoleta de embutir. /

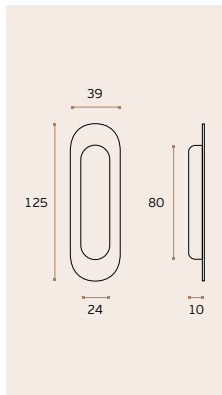

**IN.16.226**

EN 1.4301-Satinado/Satin/Satin  
**Concha de embutir./**  
Concealed flush handle./  
Cazoleta de embutir. /

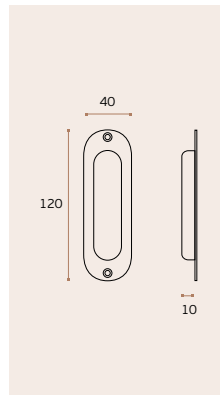

**IN.16.227**

EN 1.4301-Satinado/Satin/Satin  
**Concha de embutir./**  
Concealed flush handle./  
Cazoleta de embutir. /

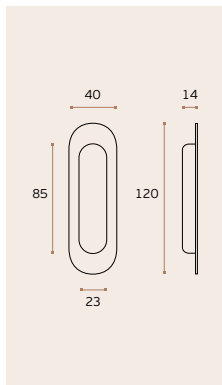

**IN.16.228**

EN 1.4301-Satinado/Satin/Satin  
**Concha de embutir./**  
Concealed flush handle./  
Cazoleta de embutir. /

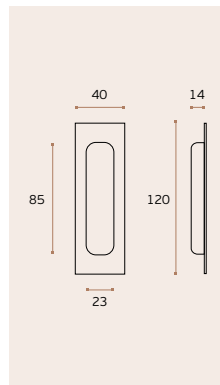

# CONCHAS / FLUSH HANDLES / CAZOLETAS.



### IN.16.404

EN 1.4301-Satinado/Satin/Satin  
**Concha com placa de mola./**  
Flush Handle with spring cover. /  
Cazoleta con cubierta de muelle.

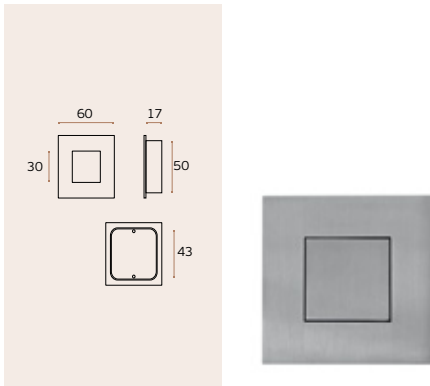

### IN.16.400

EN 1.4301-Satinado/Satin/Satin  
**Concha com placa de mola./**  
Flush Handle with spring cover. /  
Cazoleta con cubierta de muelle.

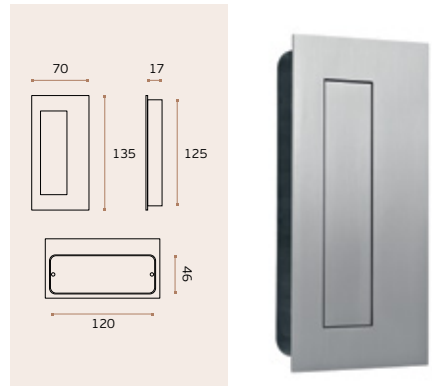

### IN.16.402

EN 1.4301-Satinado/Satin/Satin  
**Concha com placa de mola./**  
Flush Handle with spring cover. /  
Cazoleta con cubierta de muelle.

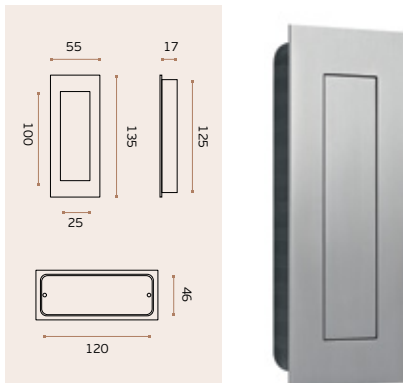

### IN.16.406

EN 1.4301-Satinado/Satin/Satin  
**Concha com placa de mola./**  
Flush Handle with spring cover. /  
Cazoleta con cubierta de muelle.

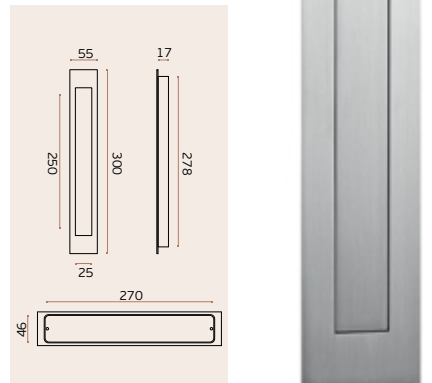

# CONCHAS / FLUSH HANDLES / CAZOLETAS.

## IN.16.414

EN 1.4301 Satinado/Satin/Satin

Concha de embutir/  
Flush Handle / Cazoleta.

## IN.16.414.P

EN 1.4301

Polido/polished/pulido

Concha de embutir/  
Flush Handle / Cazoleta.

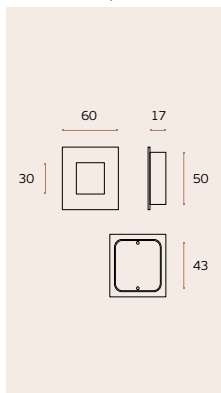

## IN.16.410

EN 1.4301 Satinado/Satin/Satin

Concha de embutir/  
Flush Handle / Cazoleta.

## IN.16.410.P

EN 1.4301

Polido/polished/pulido

Concha de embutir/  
Flush Handle / Cazoleta.

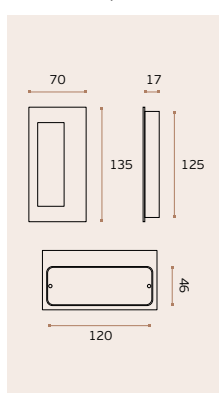

## IN.16.412

EN 1.4301 Satinado/Satin/Satin

Concha de embutir./  
Flush Handle. /Cazoleta.

## IN.16.412.P

EN 1.4301

Polido/polished/pulido

Concha de embutir/  
Flush Handle / Cazoleta.

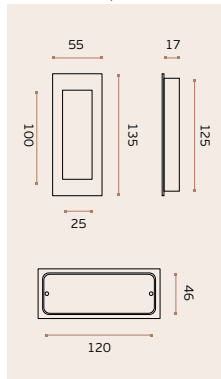

## IN.16.416

EN 1.4301 Satinado/Satin/Satin

Concha de embutir./  
Flush Handle. /Cazoleta.

## IN.16.416.P

EN 1.4301

Polido/polished/pulido

Concha de embutir/  
Flush Handle / Cazoleta.

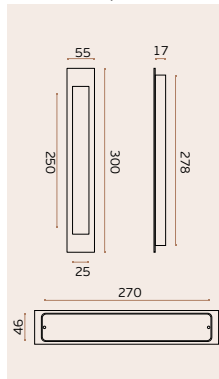



### IN.16.312

EN 1.4301-Satinado/Satin/Satin  
**Concha de embutir./**  
Concealed flush handle./  
Cazoleta de embutir. /

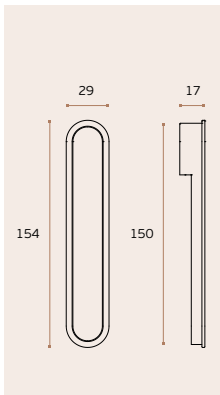

### IN.16.314

EN 1.4301-Satinado/Satin/Satin  
**Concha de embutir./**  
Concealed flush handle./  
Cazoleta de embutir. /

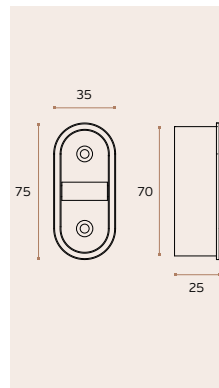

**Conchas para aplicar no topo das portas de correr. Permite recolher a porta totalmente entre duas paredes /**

Flush handles to install on the front of sliding doors. Allows to collect the door fully between two walls. / Cazoleta para instalar en la parte frontal de las puertas correderas. Permite recoger

la puerta por completo entre dos paredes.

### IN.16.310

EN 1.4301-Satinado/Satin/Satin  
**Concha de embutir./**  
Concealed flush handle./  
Cazoleta de embutir. /

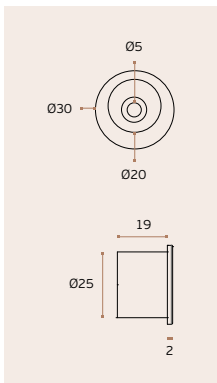

### IN.16.315

EN 1.4301-Satinado/Satin/Satin  
**Concha de embutir./**  
Concealed flush handle./  
Cazoleta de embutir. /

