



D



**FERRAGENS
DIVERSAS /**

GENERAL
HARDWARE /
HERRAJES
DIVERSAS.

BATENTES / DOOR STOPPERS / TOPES DE PUERTA.



IN.13.186

Material: EN 1.4301 - Satinado / Satin / Satin

Retenedor de porta magnético / Magnetic door holder /
Retenedor de puerta magnético.

Design: Christian Magalhães

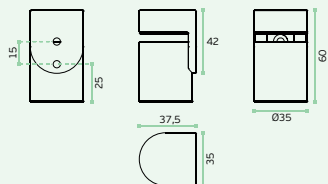

IN.13.187

Material: EN 1.4301 - Satinado / Satin / Satin

Batente de porta com retenção magnética para porta em vidro / Door stopper with magnetic holder for glass door /
Tope de puerta con retenedor magnetico para puerta en cristal.
Espessura de vidro/ Glass thickness/ Espesor del cristal **8-12mm**

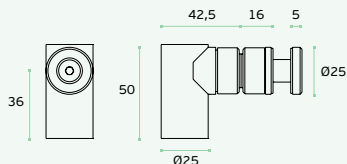

IN.13.189

Material: EN 1.4301 - Satinado / Satin / Satin

Batente de porta com retenção magnética / Door stopper
with magnetic holder / Tope de puerta magnetico.

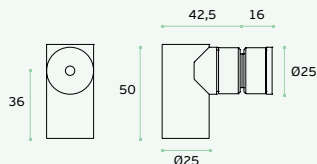

BATENTE DE PAVIMENTO COM RETENTOR MAGNÉTICO / DOOR STOPPER WITH MAGNETIC RETAINER / TOPE DE PUERTA CON RETENEDOR MAGNÉTICO.

Sistema magnético com curso, para ajuste automático a diferentes distâncias da porta ao pavimento e simultaneamente, reduz a precisão na instalação. Ao aproximar a porta do batente, o magnético sobe e reduz a velocidade do fecho da porta até à sua imobilização.

Magnetic system with automatic height adjustment to different distances from the door to the floor and simultaneously, reduces installation accuracy. When approaching the door to the stopper, the magnetic rises and reduces the closing speed of the door until it stops.

Sistema magnético con ajuste automático de la altura a diferentes distancias de la puerta al suelo y al mismo tiempo reduce la precisión en la instalación. Al acercarse la puerta del tope, lo magnético empieza a subir y ralentiza la velocidad de cierre de la puerta hasta sólo retencion.

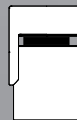
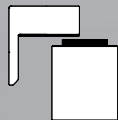
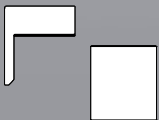
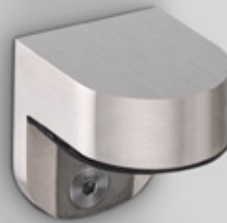
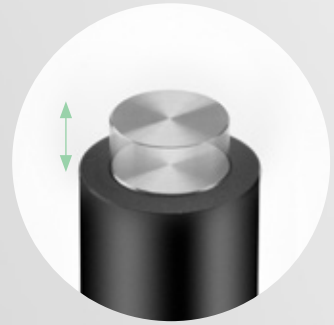

BATENTES / DOOR STOPPERS / TOPES DE PUERTA.



IN.23.009

Material: EN 1.4301 - Satinado / Satin / Satin

Retenedor de Porta /

Door holder / Retenedor de Puerta.

Design: Miguel Vasconcelos

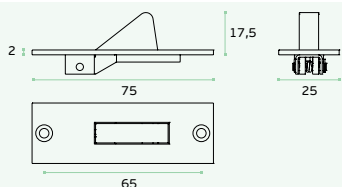

IN.13.010

Material: EN 1.4301 - Satinado / Satin / Satin

Batente de chão para portas pesadas com amortecedor e retentor / Door stopper for heavy doors with shock absorber and retainer / Tope de puerta para puertas pesadas con amortiguador y retenedor.

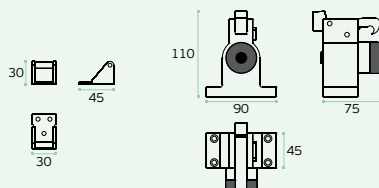

IN.13.011

Material: EN 1.4301 - Satinado / Satin / Satin

Batente de chão para portas pesadas com amortecedor / Door stopper for heavy doors with shock absorber / Tope de puerta para puertas pesadas con amortiguador.

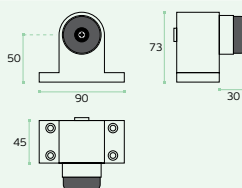



IN.23.125

Material: EN 1.4301 - Satinado /
Satin / Satin
Retenedor de Porta /
Door holder / Retenedor de puerta

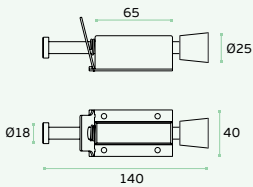

IN.23.126

Material: EN 1.4301 - Satinado /
Satin / Satin
Retenedor de Porta /
Door holder / Retenedor de puerta

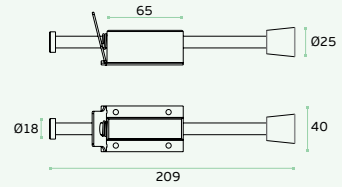

IN.23.127

Material: EN 1.4301 - Satinado /
Satin / Satin
Retenedor de Porta /
Door holder / Retenedor de puerta

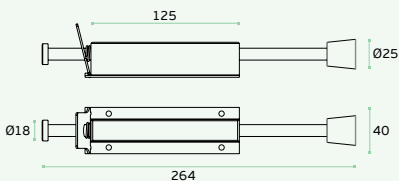

BATENTES / DOOR STOPPERS / TOPES DE PUERTA.



IN.13.106.20

Material: EN 1.4372 - Satinado / Satin / Satin
Batente de chão / Door stopper / Tope de puerta.

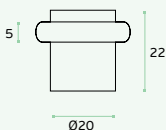

IN.13.106.25

Material: EN 1.4372 - Satinado / Satin / Satin
Batente de chão / Door stopper / Tope de puerta.

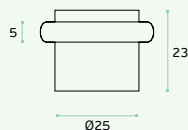

IN.13.120

Material: EN 1.4301 - Satinado / Satin / Satin
Batente de chão / Door stopper / Tope de puerta.

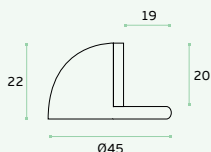

IN.13.121.T.20

Material: EN 1.4301 - Satinado / Satin / Satin
Batente de chão / Door stopper / Tope de puerta.

IN.13.121.T.20.ECO

Material: EN 1.4372 - Satinado / Satin / Satin

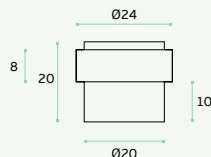

**IN.13.121.20**

Material: EN 1.4301 - Satinado / Satin / Satin
Batente de chão / Door stopper / Tope de puerta.

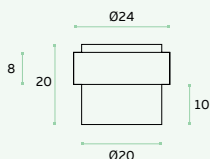
**IN.13.121.30.ECO**

Material: EN 1.4372 - Satinado / Satin / Satin
Batente de chão / Door stopper / Tope de puerta.

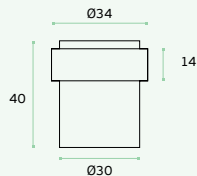
**IN.13.121.20.TB**

Material: EN 1.4301 + TITANIUM - Black
 Satinado / Satin / Satin

**IN.13.121.20.TG**

Material: EN 1.4301 + TITANIUM - Gold
 Satinado / Satin / Satin

**IN.13.121.30.ECO.TB**

Material: EN 1.4372 + TITANIUM - Black
 Satinado / Satin / Satin

**IN.13.121.30.ECO.TG**

Material: EN 1.4372 + TITANIUM - Gold
 Satinado / Satin / Satin

**IN.13.121.20.TCO**

Material: EN 1.4301 + TITANIUM - Copper
 Satinado / Satin / Satin

**IN.13.121.20.TCH**

Material: EN 1.4301 + TITANIUM - Chocolate
 Satinado / Satin / Satin

**IN.13.121.30.ECO.TCO**

Material: EN 1.4372 + TITANIUM - Copper
 Satinado / Satin / Satin

**IN.13.121.30.ECO.TCH**

Material: EN 1.4372 + TITANIUM - Chocolate
 Satinado / Satin / Satin

BATENTES / DOOR STOPPERS / TOPES DE PUERTA.



IN.13.122

Material: EN 1.4301 - Satinado / Satin / Satin
Batente de chão / Door stopper / Tope de puerta.

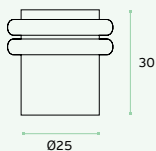

CF.13.020 INFORMAL

Material: EN 1.4301 - Satinado / Satin / Satin
Batente de chão / Door stopper / Tope de puerta.
Design: Catarina Fernandes

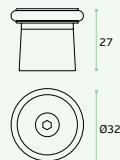



IN.13.123.CB.06

Material: EN 1.4301 - Satinado / Satin / Satin

Batente de porta para fixar na parede /

Door stopper for wall fixing /

Tope de puerta para fijar en la pared.

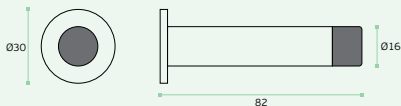

IN.13.123.CB

Material: EN 1.4301 - Satinado / Satin / Satin

Batente de porta para fixar na parede /

Door stopper for wall fixing /

Tope de puerta para fijar en la pared.

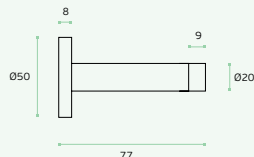

NEW

IN.13.123.SB_

Material: EN 1.4301 - Satinado / Satin / Satin

Batente de porta para fixar na parede /

Door stopper for wall fixing /

Tope de puerta para fijar en la pared.

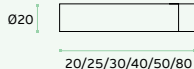

IN.13.112.10 / IN.13.112.20

Material: EN 1.4301 - Satinado / Satin / Satin

Batente de porta para colar no vidro /

Door stopper to glue in the glass /

Tope de puerta para pegar en cristal.

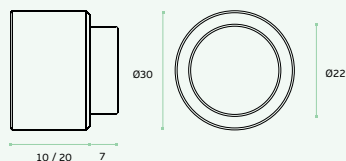

BATENTES / DOOR STOPPERS / TOPES DE PUERTA.



IN.13.111.20

Material: EN 1.4301 - Satinado / Satin / Satin

Batente de porta para fixar na parede /

Door stopper for wall fixing /

Tope de puerta para fijar en la pared.

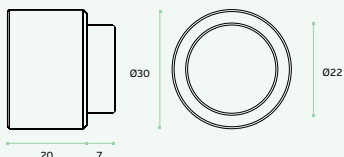

IN.13.111.30

Material: EN 1.4301 - Satinado / Satin / Satin

Batente de porta para fixar na parede /

Door stopper for wall fixing /

Tope de puerta para fijar en la pared.

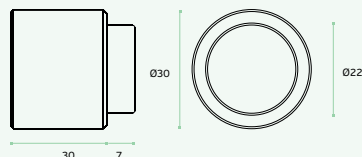

IN.13.111.35

Material: EN 1.4301 - Satinado / Satin / Satin

Batente de porta para fixar na parede /

Door stopper for wall fixing /

Tope de puerta para fijar en la pared.

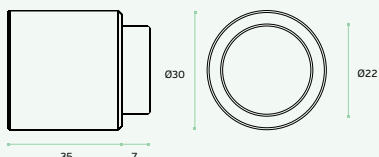

IN.13.111.50

Material: EN 1.4301 - Satinado / Satin / Satin

Batente de porta para fixar na parede /

Door stopper for wall fixing /

Tope de puerta para fijar en la pared.

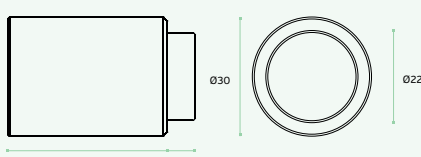

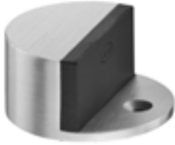

IN.13.004

Material: EN 1.4301 - Satinado / Satin / Satin
Batente de chão / Door stopper / Tope de puerta.
Design: Miguel Vasconcelos

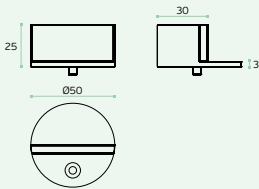

IN.13.005

Material: EN 1.4301 - Satinado / Satin / Satin
Batente de chão / Door stopper / Tope de puerta.
Design: Miguel Vasconcelos

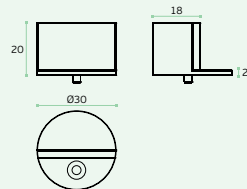

IN.13.125

Material: EN 1.4301 - Satinado / Satin / Satin
Batente de chão / Door stopper / Tope de puerta.

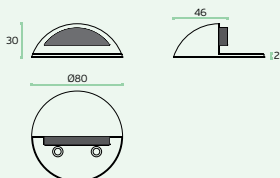

IN.13.240

Material: EN 1.4301 - Satinado / Satin / Satin
Batente de chão / Door stopper / Tope de puerta.

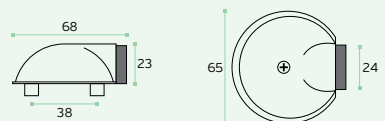

BATENTES / DOOR STOPPERS / TOPES DE PUERTA.



SR.13.006.B SKIN

Material: EN 1.4301 - Satinado / Satin / Satin

Pele Natural Castanho /

Natural Leather Brown / Cuero Natural Marron

Batente de chão / Door stopper / Tope de puerta.

Design: Susana Ribeiro

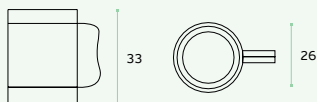

SR.13.006.C SKIN

Material: EN 1.4301 - Satinado / Satin / Satin

Pele Natural Camel /

Natural Leather Camel / Cuero Natural Camel

Batente de chão / Door stopper / Tope de puerta.

Design: Susana Ribeiro

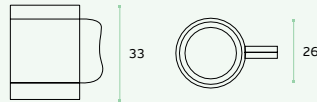

SR.13.006.N SKIN

Material: EN 1.4301 - Satinado / Satin / Satin

Pele Natural Preto /

Natural Leather Black / Cuero Natural Negro

Batente de chão / Door stopper / Tope de puerta.

Design: Susana Ribeiro

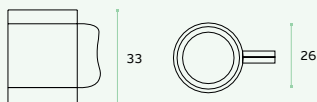

IN.13.006 ERGO FORM

Material: EN 1.4301 - Satinado / Satin / Satin

Batente de chão / Door stopper / Tope de puerta.

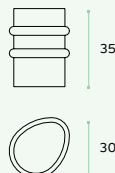



IN.13.185.30 LOFT

Material: EN 1.4301 - Satinado / Satin / Satin
Batente de chão / Door stopper / Tope de puerta.
Design: Christian Magalhães

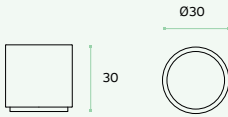

IN.13.185.50 LOFT

Material: EN 1.4301 - Satinado / Satin / Satin
Batente de chão / Door stopper / Tope de puerta.
Design: Christian Magalhães

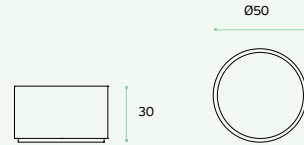

IN.13.BS.25 IN.13.BS.30 IN.13.BS.35

Material: EN 1.4301 - Satinado / Satin / Satin
Base para batente de chão - com adesivo extra forte /
Door stopper base - with special sticker /
Base para tope de puerta - con pegamiento extra fuerte.

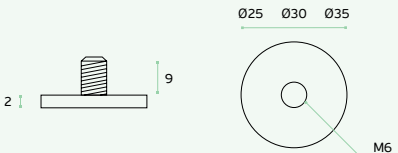

SKIN SR.13.006.B.BS25 LOFT IN.13.185.30.BS30 IN.13.186.BS35

Exemplo / Example / Ejemplo

BATENTES / DOOR STOPPERS / TOPES DE PUERTA.



RR.13.005 SIMPULLPUSH

Material: EN 1.4301 - Satinado / Satin / Satin
Batente de chão / Door stopper / Tope de puerta.
Design: Rita Rodrigues

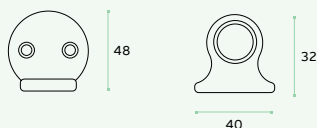

MV.13.020 TUBYK

EN 1.4301 - Satinado / Satin / Satin
Batente de chão / Door stopper / Tope de puerta.
Design: Miguel Vasconcelos

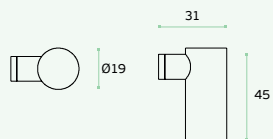

IN.14.601.S

Material: Alumínio / Aluminium / Aluminio
Cor Inox Satinado / Stainless Steel Color / Color inox satin
Cabide / Hook / Percha.
Design: Christian Magalhães

IN.14.601.B Black

Material: Alumínio / Aluminium / Aluminio
Preto escovado Mate / Black Matte Satin / Negro satin mate

IN.14.601.P

Material: Alumínio / Aluminium / Aluminio
Polido / Polished / Pulido

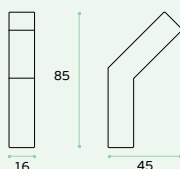



IN.13.119 QUADRO

Material: EN 1.4301 - Satinado / Satin / Satin

IN.13.119.P QUADRO

Material: EN 1.4301 - Polido / Polished / Pulido

Batente de chão / Door stopper / Tope de puerta.

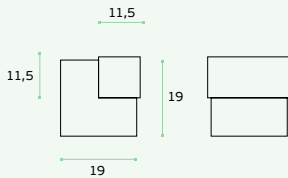

IN.13.355 DUO

Material: EN 1.4301 - Satinado / Satin / Satin

IN.13.355.P DUO

Material: EN 1.4301 - Polido / Polished / Pulido

Batente de chão / Door stopper / Tope de puerta.

Design: Pedro Queirós

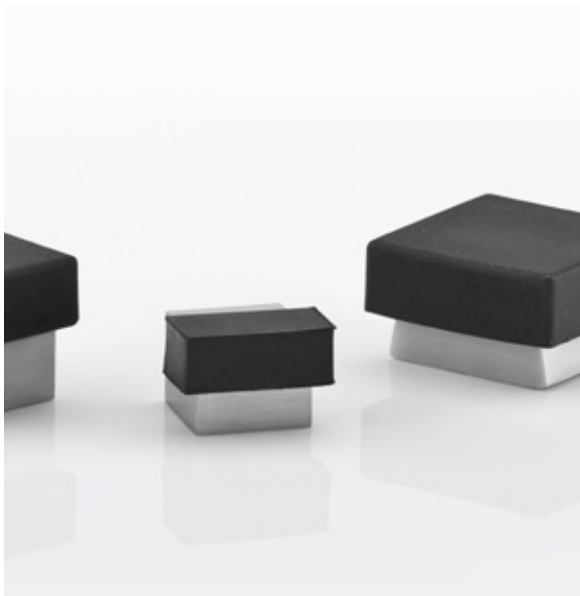
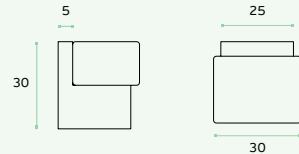

IN.13.356

Material: EN 1.4301 - Satinado / Satin / Satin

IN.13.356.P

Material: EN 1.4301 - Polido / Polished / Pulido

Batente de chão / Door stopper / Tope de puerta.

Design: Pedro Queirós

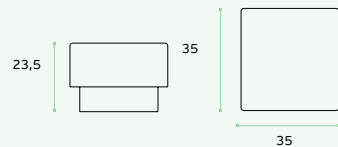

CABIDES / HOOKS / PERCHAS.

IN.14.506

Material: EN 1.4301 - Satinado / Satin / Satin
Cabide / Hook / Percha.

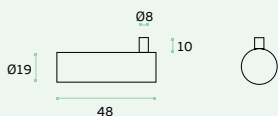

IN.14.501

Material: EN 1.4301 - Satinado / Satin / Satin
Cabide / Hook / Percha.

IN.14.501.6 - Com adesivo / With glue/ Con pegamiento.
Peso Máx./ Max weight / Peso max. - 2Kg

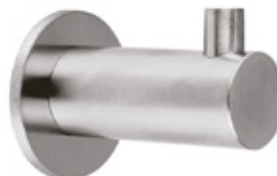
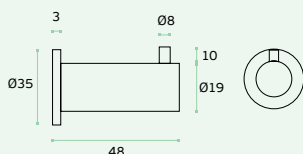

IN.14.501.V

Material: EN 1.4301 - Satinado / Satin / Satin
Cabide para vidro /
Hook for glass / Percha para cristal.

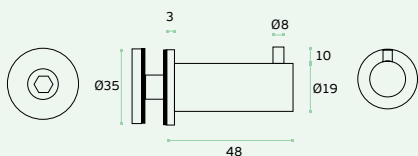

IN.14.515

Material: EN 1.4301 - Satinado / Satin / Satin
Cabide / Hook / Percha.

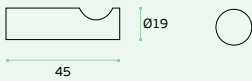

IN.14.510

Material: EN 1.4301 - Satinado / Satin / Satin
Cabide / Hook / Percha.
IN.14.510.G - Com adesivo / With glue / Con pegamiento.
Peso Máx. / Max weight / Peso max. - 2Kg

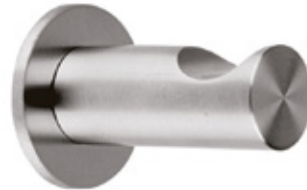
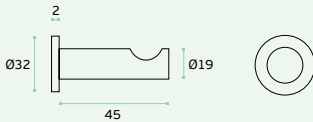

IN.14.510.V

Material: EN 1.4301 - Satinado / Satin / Satin
Cabide para vidro /
Hook for glass / Percha para cristal.

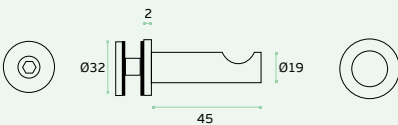

CABIDES / HOOKS / PERCHAS.

IN.14.500

Material: EN 1.4301 - Satinado / Satin / Satin
Cabide / Hook / Percha.

IN.14.500.G - Com adesivo/ With glue/ Con pegamiento.

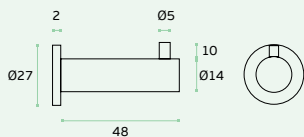

IN.14.505

Material: EN 1.4301 - Satinado / Satin / Satin
Cabide / Hook / Percha.

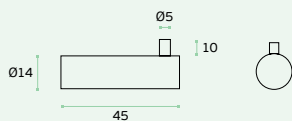

NEW

IN.14.010

Material: EN 1.4301 - Satinado / Satin / Satin
Cabide / Hook / Percha.

Design: Pedro Queirós

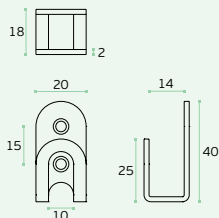

NEW

IN.14.546

Material: EN 1.4301 - Satinado / Satin / Satin
Cabide / Hook / Percha.

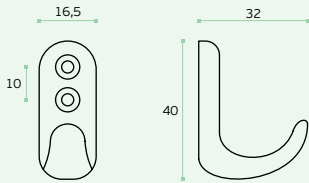

NEW

IN.14.547

Material: EN 1.4401 - Satinado / Satin / Satin
Cabide / Hook / Percha.

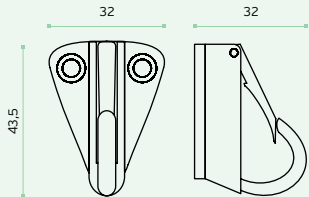

NEW

IN.14.548

Material: EN 1.4401 - Satinado / Satin / Satin
Cabide / Hook / Percha.

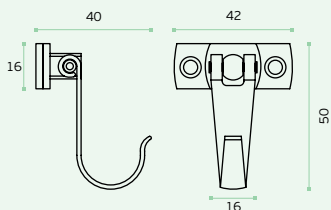

CABIDES / HOOKS / PERCHAS.

IN.14.520

Material: EN 1.4301 - Satinado / Satin / Satin
Cabide / Hook / Percha.

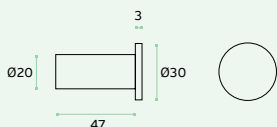

IN.14.525

Material: EN 1.4301 - Satinado / Satin / Satin
Cabide / Hook / Percha.

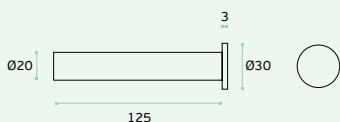

IN.14.418 WENGÉ

Material: EN 1.4301 - Satinado / Satin / Satin
Cabide / Hook / Percha.
Design: Pedro Queirós

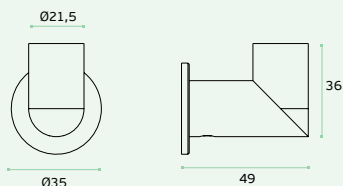

AM.14.011 TOUCH IT

Material: EN 1.4301 - Satinado / Satin / Satin

Cabide / Hook / Percha.

Design: Ana Moreira

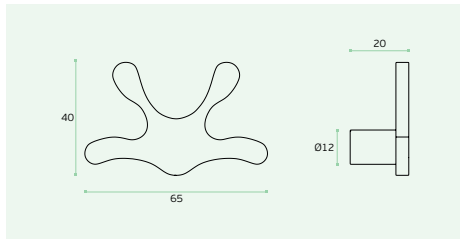

CS.14.004 MIMETIC

Material: EN 1.4301 - Satinado / Satin / Satin

Cabide / Hook / Percha.

Design: Cátia Sul

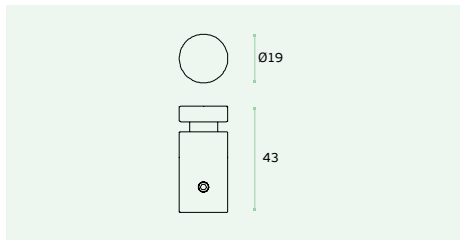

CS.14.004.Q MIMETIC

Material: EN 1.4301 - Satinado / Satin / Satin

Cabide / Hook / Percha.

Design: Cátia Sul

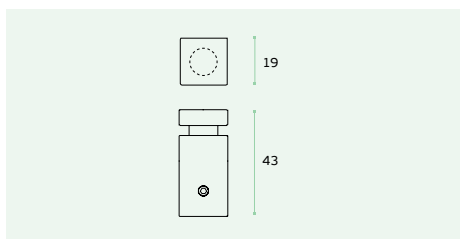

CABIDES / HOOKS / PERCHAS.

IN.14.177 QUADRO

Material: EN 1.4301 - Satinado / Satin / Satin

Cabide / Hook / Percha.

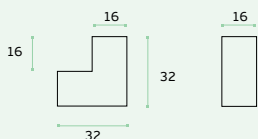

RV.14.002 SUBTIL

Material: EN 1.4301 - Satinado / Satin / Satin

Cabide / Hook / Percha.

Design: Rui Viana

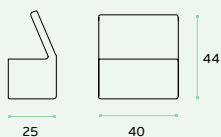

MR.14.006 MERIDIAN

Material: EN 1.4301 - Satinado / Satin / Satin

Cabide / Hook / Percha.

Design: Evol

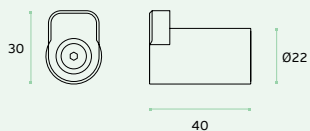

IN.14.300.14 BRANCH

Material: EN 1.4301 - Satinado / Satin / Satin
Cabide / Hook / Percha.

Design: Christian Magalhães

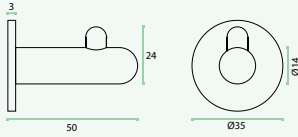

IN.14.300.19 BRANCH

Material: EN 1.4301 - Satinado / Satin / Satin
Cabide / Hook / Percha.

Design: Christian Magalhães

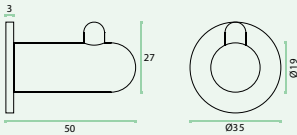

IN.14.535

Material: EN 1.4301 - Satinado / Satin / Satin
Cabide Triplo / Triple Hook / Percha Triple.

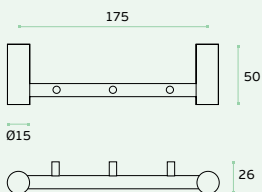

CABIDES / HOOKS / PERCHAS.

IN.14.544

Material: EN 1.4301 - Satinado / Satin / Satin
Cabide / Hook / Percha.

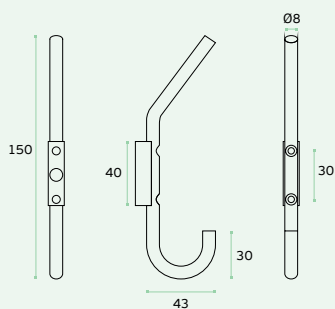

IN.14.545

Material: EN 1.4301 - Satinado / Satin / Satin
Cabide / Hook / Percha.

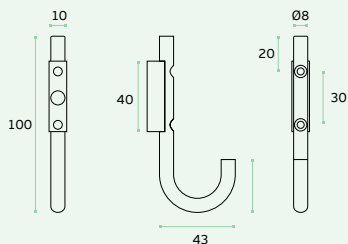

IN.14.540

Material: EN 1.4301 - Satinado / Satin / Satin
Cabide / Hook / Percha.

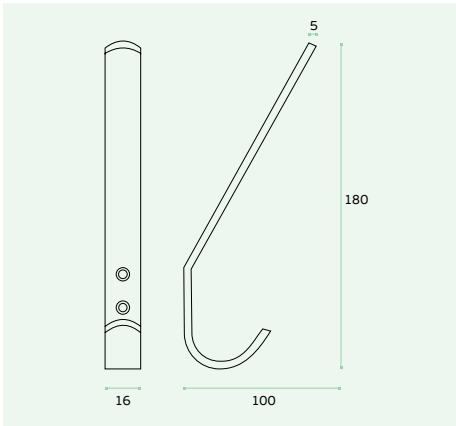

IN.14.541

Material: EN 1.4301 - Satinado / Satin / Satin
Cabide / Hook / Percha.

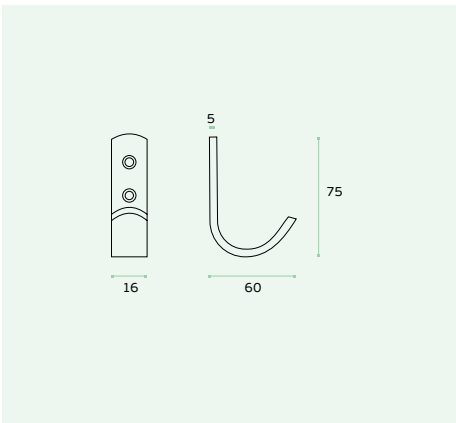

CABIDES / HOOKS / PERCHAS.

IN.14.542

Material: EN 1.4301 - Satinado / Satin / Satin
Cabide / Hook / Percha.

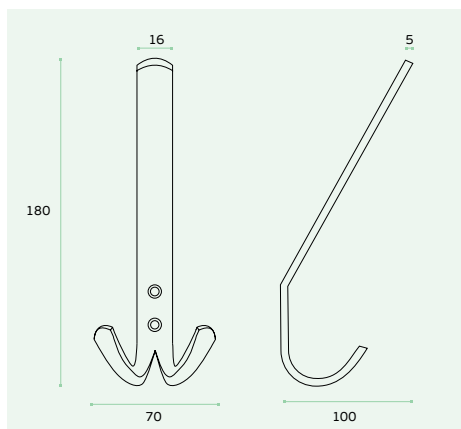

IN.14.543

Material: EN 1.4301 - Satinado / Satin / Satin
Cabide / Hook / Percha.

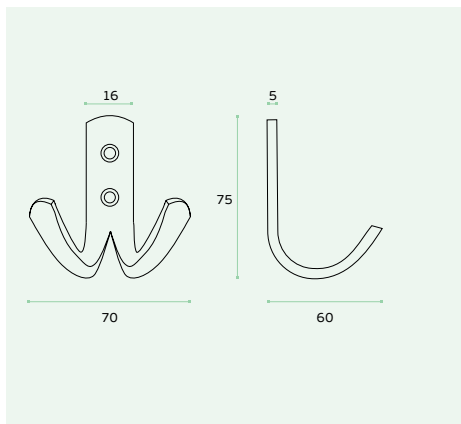

IN.14.536

Material: EN 1.4301 - Satinado / Satin / Satin
Cabide / Hook / Percha.

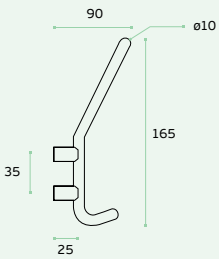

IN.14.537

Material: EN 1.4301 - Satinado / Satin / Satin
Cabide / Hook / Percha.

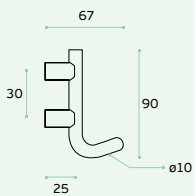

CABIDES / HOOKS / PERCHAS.

IN.14.538

EN 1.4301 Satinado / Satin / Satin
Cabide / Hook / Percha.

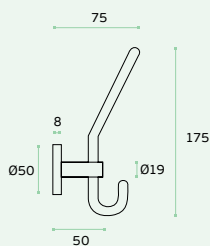

IN.14.539

Material: EN 1.4301 - Satinado / Satin / Satin
Cabide / Hook / Percha.

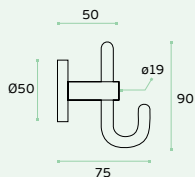

IN.14.528

Material: EN 1.4301 - Satinado / Satin / Satin
Cabide / Hook / Percha.

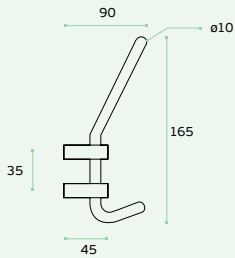

IN.14.509.35

Material: EN 1.4301 - Satinado / Satin / Satin
Cabide / Hook / Percha.

Espessura da porta 35mm /

Door Thickness 35mm / Espesor de puerta 35mm

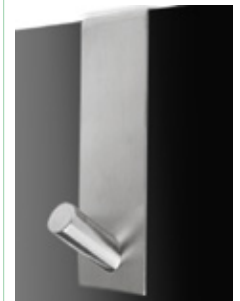
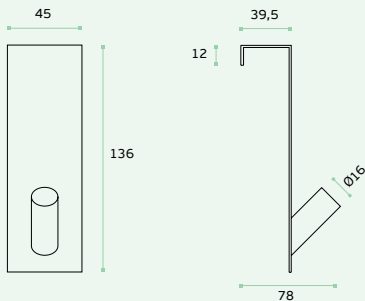

CABIDES / HOOKS / PERCHAS.

IN.14.400

Material: EN 1.4301 Satinado / Satin / Satin
+ Alumínio / Aluminium / Aluminio

Cabide / Hook / Percha.

Design: Christian Magalhães

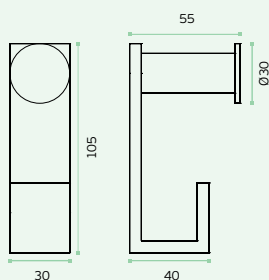

IN.14.502

Material: EN 1.4301 Satinado / Satin / Satin
+ Alumínio / Aluminium / Aluminio

Cabide / Hook / Percha.

Design: Christian Magalhães

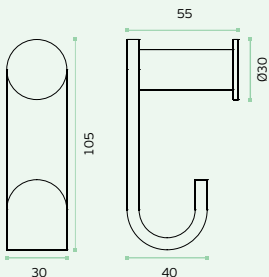



CABIDES / HOOKS / PERCHAS.

IN.14.526

Material: EN 1.4301 - Satinado / Satin / Satin

Cabide Duplo / Double Hook / Percha doble

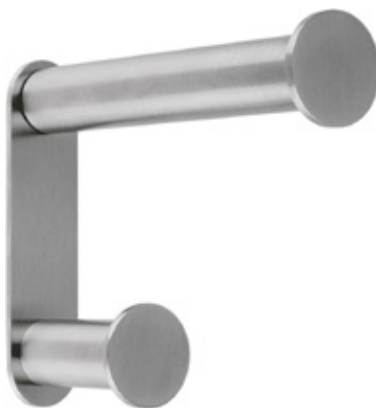
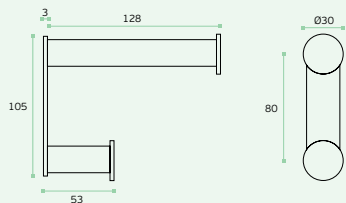

IN.14.527

Material: EN 1.4301 - Satinado / Satin / Satin

Cabide Duplo / Double Hook / Percha doble

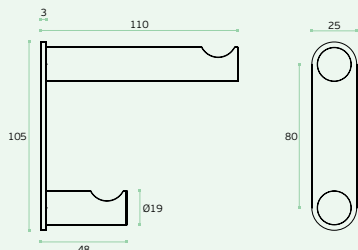

IN.14.300.3.14 BRANCH

Material: EN 1.4301 - Satinado / Satin / Satin

Cabide Triplo / Triple Hook / Percha Triple.

Design: Christian Magalhães

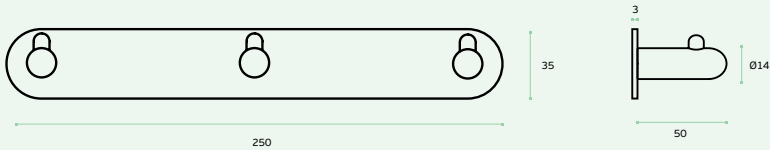

IN.14.300.3.19 BRANCH

Material: EN 1.4301 - Satinado / Satin / Satin

Cabide Triplo / Triple Hook / Percha Triple.

Design: Christian Magalhães

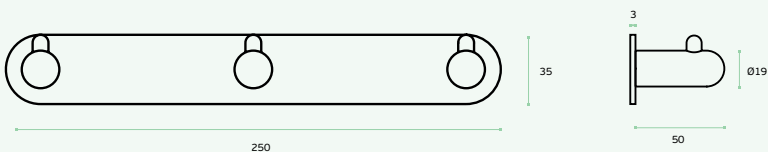

CABIDES / HOOKS / PERCHAS.

IN.14.505.3

Material: EN 1.4301 - Satinado / Satin / Satin

Cabide Triplo / Triple Hook / Percha Triple.

IN.14.505.3.G - Com adesivo/ With glue/ Con pegamiento.

Peso Máx./ Max weight/ Peso max. - 3Kg

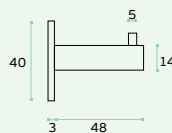
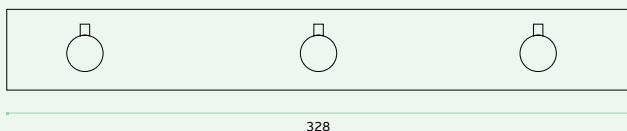

IN.14.506.3

Material: EN 1.4301 - Satinado / Satin / Satin

Cabide Triplo / Triple Hook / Percha Triple.

IN.14.506.3.G - Com adesivo/ With glue/ Con pegamiento.

Peso Máx./ Max weight/ Peso max. - 3Kg

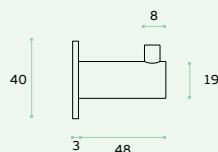
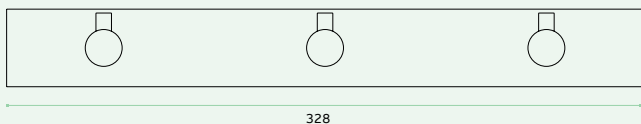

IN.14.520.3

Material: EN 1.4301 - Satinado / Satin / Satin

Cabide Triplo / Triple Hook / Percha Triple.

IN.14.520.3.G - Com adesivo/ With glue/ Con pegamiento.

Peso Máx./ Max weight/ Peso max. - 3Kg

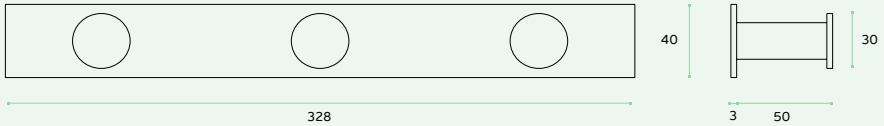

IN.14.177.3

Material: EN 1.4301 - Satinado / Satin / Satin

Cabide Triplo / Triple Hook / Percha Triple.

IN.14.177.3.G - Com adesivo/ With glue/ Con pegamiento.

Peso Máx./ Max weight/ Peso max. - 3Kg



CABIDES / HOOKS / PERCHAS.

AM.14.012 TOUCH IT

Material: EN 1.4301 - Satinado / Satin / Satin

Cabide Triplo / Triple Hook / Percha Triple.

AM.14.012.G - Com adesivo/ With glue/ Con pegamiento.

Peso Máx./ Max weight/ Peso max. - 3Kg

Design: Ana Moreira

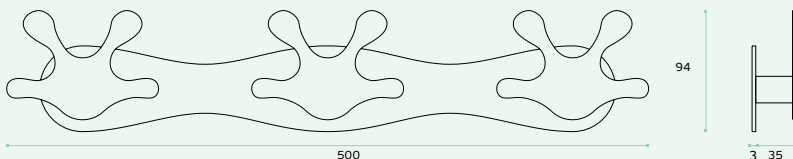

IN.14.600

Material: EN 1.4301 - Satinado / Satin / Satin

Cabide Quádruplo / Quadruple Hook / Percha Quádruplo.

IN.14.600.G - Com adesivo/ With glue/ Con pegamiento.

Peso Máx./ Max weight/ Peso max. - 3Kg

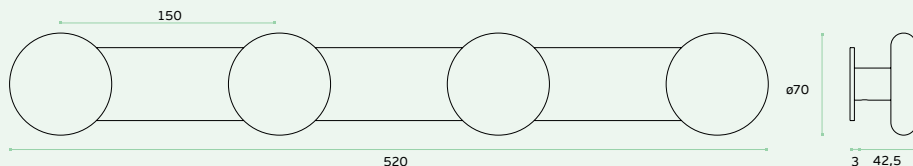

CABIDES / HOOKS / PERCHAS.



D/536

Ferragens diversas /
General hardware /
Herrajes diversas.

Cabides /
Hooks /
Perchas.

www.jnf.pt

CABIDES / HOOKS / PERCHAS.



IN.14.533

Material: EN 1.4301 - Satinado / Satin / Satin
Cabide de Pé / Floor Hook / Percha de Suelo.

Design: Pedro Queirós

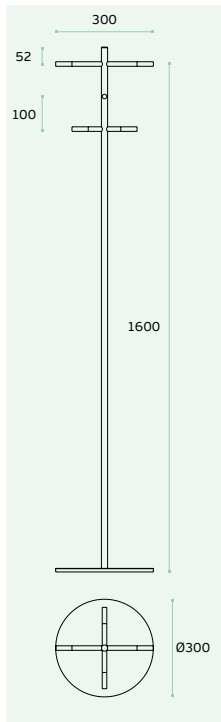

CRUZETA PARA HOTEL / HOTEL CLOTH HANGER / PERCHA PARA HOTEL.

IN.23.410

Material: EN 1.4301 - Satinado / Satin / Satin
Cruzeta para hotel /
Hotel cloth hanger / Percha para hotel.

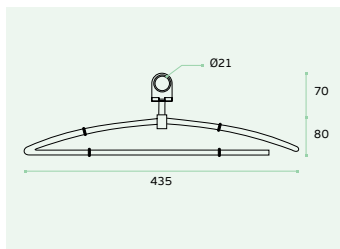

IN.23.411

Material: EN 1.4301 - Satinado / Satin / Satin
Cruzeta para hotel /
Hotel cloth hanger / Percha para hotel.

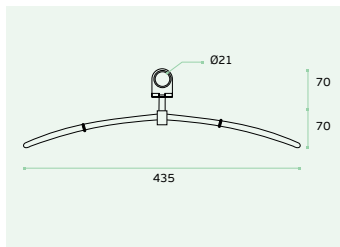

IN.23.412

Material: EN 1.4301 - Satinado / Satin / Satin
Cruzeta / Cloth hanger / Percha.

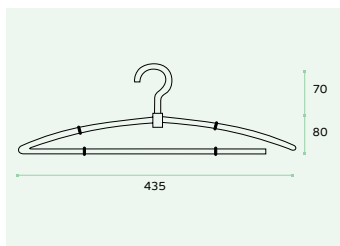

CRUZETA / CLOTH HANGER / PERCHA.

IN.23.413

Material: EN 1.4301 - Satinado / Satin / Satin
Cruzeta / Cloth hanger / Percha.

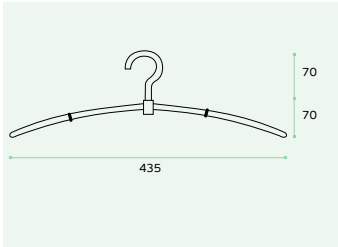

NEW

IN.23.414

Material: EN 1.4301 - Satinado / Satin / Satin
Cabide / Hook / Percha.

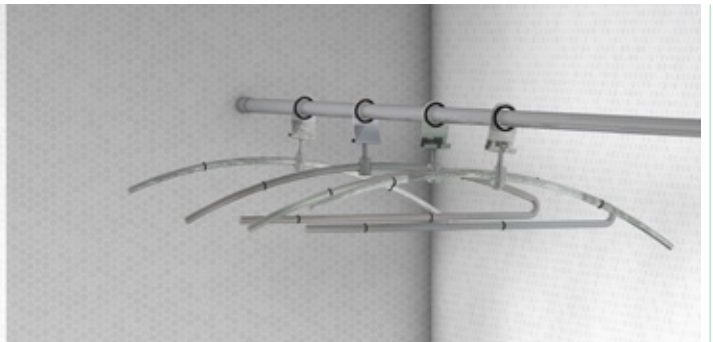
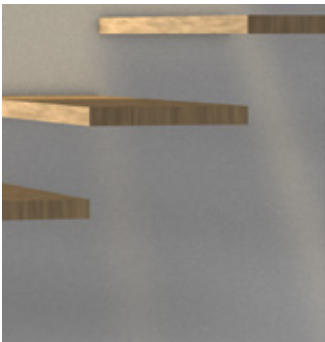
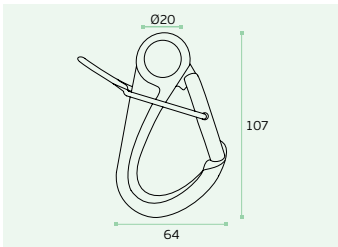

SUportes DE TUBO / TUBE SUPPORTS / SOPORTES DE TUBO.

IN.23.542.16 IN.23.542.19

Material: EN 1.4301 - Satinado / Satin / Satin
Suporte de Tubo /
Tube Support / Soporte de Tubo.

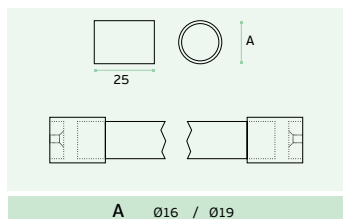

IN.23.543.16 IN.23.543.19

Material: EN 1.4301 - Satinado / Satin / Satin
Suporte de Tubo /
Tube Support / Soporte de Tubo.

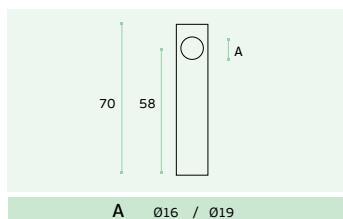

IN.23.545.16 IN.23.545.19

Material: EN 1.4301 - Satinado / Satin / Satin
Suporte de Tubo /
Tube Support / Soporte de Tubo.

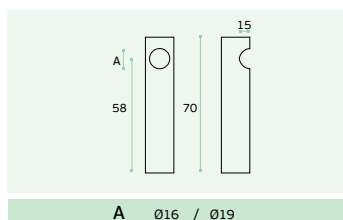

IN.23.600.16 IN.23.600.19 IN.23.600.25

Material: EN 1.4301 - Satinado / Satin / Satin
Tubo / Tube / Tubo.

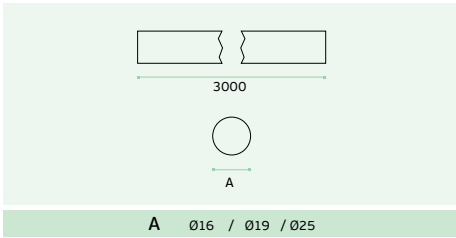

IN.23.544.16 IN.23.544.19 IN.15.016

IN.23.544.16: Ø16 **IN.23.544.19:** Ø19 **IN.15.016:** Ø25

Material: EN 1.4301 - Satinado / Satin / Satin
Terminal para aplicar no tubo IN.23.600.16/19/25

A fixação desta peça é feita por encaixe ///
Terminal to apply in tube IN.23.600.16/19/25

The setting of this part is made by click ///
Terminal a aplicarse en el tubo IN.23.600.16/19/25
El ajuste de esta parte es hecho por click.

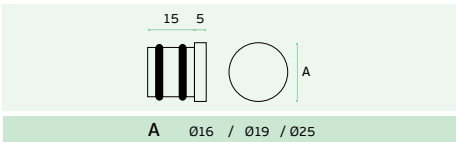

IN.43.590

Material: EN 1.4301 - Satinado / Satin / Satin
Suporte de gravatas /
Tie support / Soporte de corbatas.

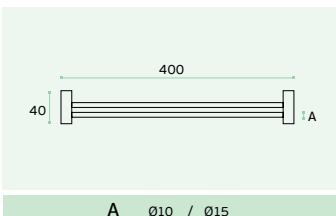

SUPORTES DE TUBO / TUBE SUPPORTS / SOPORTES DE TUBO.

IN.23.550.70 IN.23.550.90 IN.23.550.110

Material: EN 1.4301 - Satinado / Satin / Satin

Suporte de Cortinas /
Curtains Support / Soporte de Cortinas.

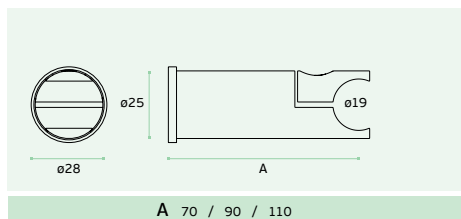

IN.23.551.70 IN.23.551.90 IN.23.551.110

Material: EN 1.4301 - Satinado / Satin / Satin

Suporte de Cortinas /
Curtains Support / Soporte de Cortinas.

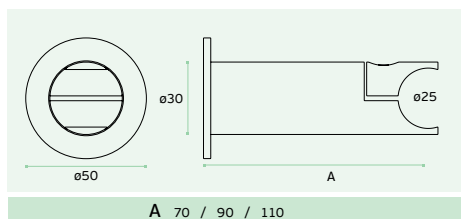

IN.23.552.19 IN.23.552.25

Terminal para aplicar no tubo IN.23.600.19/25

A fixação desta peça é feita por encaixe. ///

Terminal to apply in tube IN.23.600.19/25

The setting of this part is made by click. ///

Terminal a aplicarse en el tubo IN.23.600.19/25

El ajuste de esta parte es hecho por click.

REF	A	B
IN.23.552.19	19	40
IN.23.552.25	25	50



PASSA CABOS / CABLE CAP / PASACABLES.

IN.22.140.60 IN.22.140.80

Material: Níquel Satinado / Satin Níquel / Níquelado Satin
Passa Cabos / Cable Cap / Pasacables.

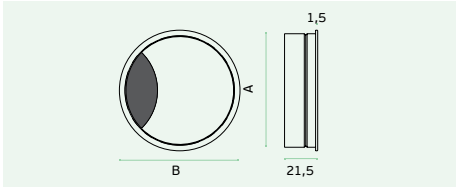

	IN.22.140.60	IN.22.140.80
A	Ø60	Ø80
B	Ø65	Ø85



FECHOS / BOLTS / CIERRES.

IN.17.605

Material: EN 1.4401
Satinado / Satin / Satin
Cremona / Window latch /
Cremona de ventana.

REF.	A	
IN.17.605.10	1000	6
IN.17.605.12	1200	6
IN.17.605.15	1500	6
IN.17.605.20	2000	8
IN.17.605.25	2500	8
IN.17.605.30	3000	9
IN.17.605.35	3500	9
IN.17.605.40	4000	10

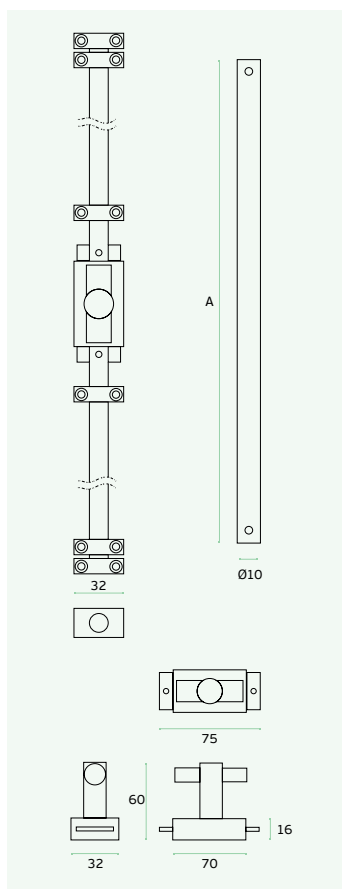

IN.17.607

Material: EN 1.4401
Satinado / Satin / Satin
Cremona / Window latch /
Cremona de ventana.

REF.	A	
IN.17.607.10	1000	6
IN.17.607.12	1200	6
IN.17.607.15	1500	6
IN.17.607.20	2000	8
IN.17.607.25	2500	8
IN.17.607.30	3000	9
IN.17.607.35	3500	9

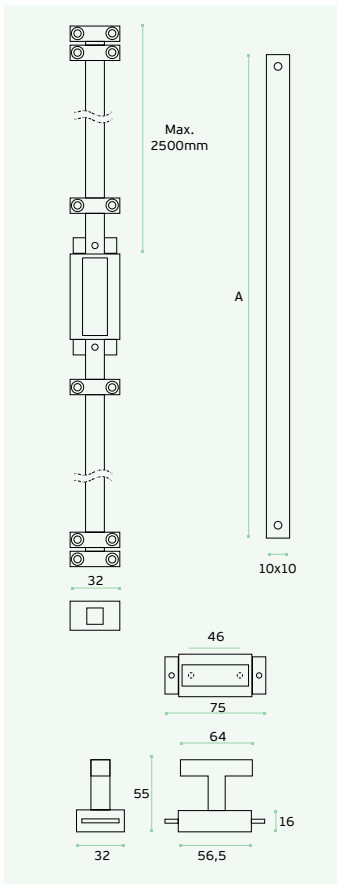

FECHOS / BOLTS / CIERRES.

IN.17.608

Material: EN 1.4401

Satinado / Satin / Satin

Cremona / Window latch /
Cremona de ventana.

REF.	A	
IN.17.608.10	1000	6
IN.17.608.12	1200	6
IN.17.608.15	1500	6
IN.17.608.20	2000	8
IN.17.608.25	2500	8
IN.17.608.30	3000	9
IN.17.608.35	3500	9

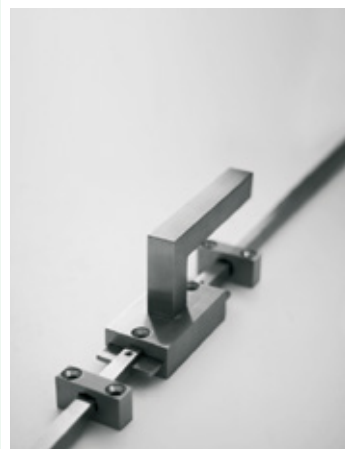
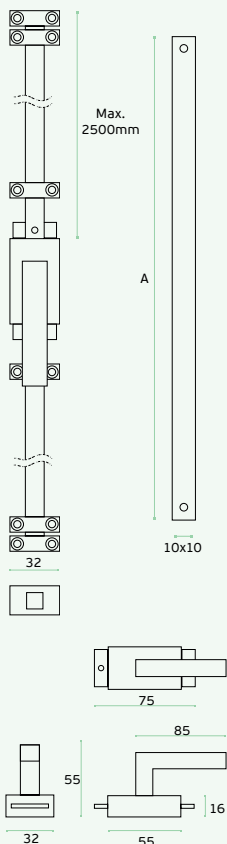

IN.17.601

Material: EN 1.4301
Satinado / Satin / Satin
Fecho / Bolt / Pasador.

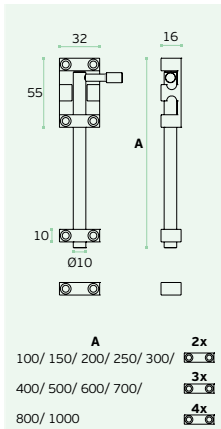

IN.17.602

Material: EN 1.4301
Satinado / Satin / Satin
Fecho / Bolt / Pasador.

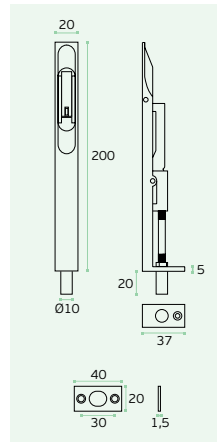

IN.17.603

Material: EN 1.4301
Satinado / Satin / Satin
Fecho / Bolt / Pasador.

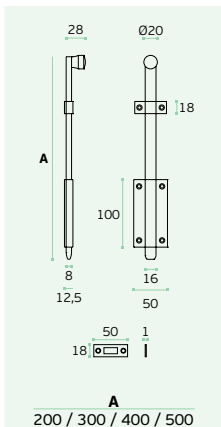

NEW

IN.17.604 HEAVY DUTY

Material: EN 1.4301
Satinado / Satin / Satin
Fecho / Bolt / Pasador.

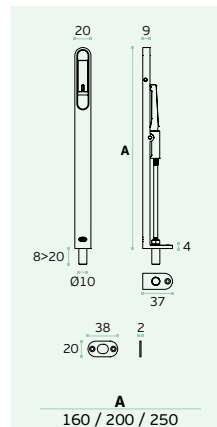

FECHOS / BOLTS / CIERRES.

NEW

IN.17.606

Material: EN 1.4301
Satinado / Satin / Satin
Fecho / Bolt / Pasador.

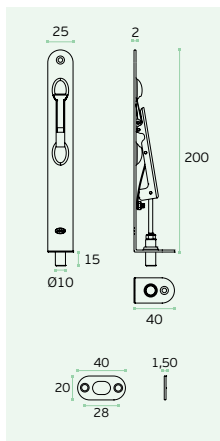

NEW

IN.17.609

Material: EN 1.4301
Satinado / Satin / Satin
Fecho / Bolt / Pasador.

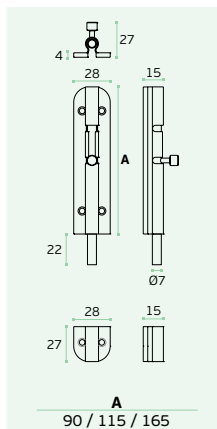

NEW

IN.17.610

Material: EN 1.4301
Satinado / Satin / Satin
Fecho / Bolt / Pasador.

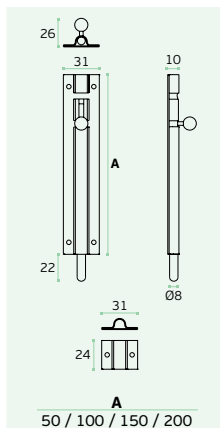

NEW

IN.17.611

Material: EN 1.4301
Satinado / Satin / Satin
Fecho / Bolt / Pasador.

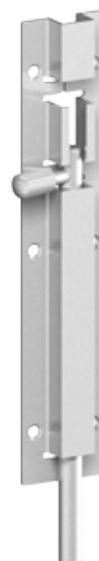
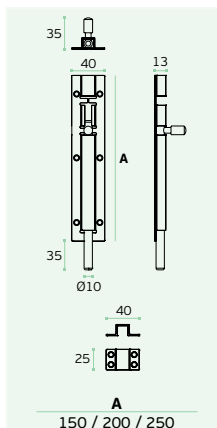

IN.17.612

Material: EN 1.4301
Satinado / Satin / Satin
Fecho / Bolt / Pasador.

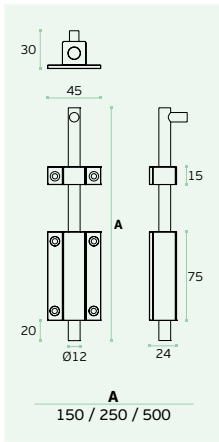

IN.17.613

Material: EN 1.4301 - Satinado / Satin / Satin
Castanha para Fecho IN.17.612 /
Strike for Bolt IN.17.612 /
Encontro para Pasador IN.17.612.

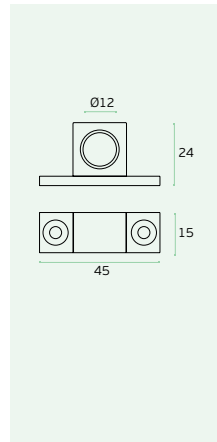

IN.17.614

Material: EN 1.4301
Satinado / Satin / Satin
Fecho / Bolt / Pasador.

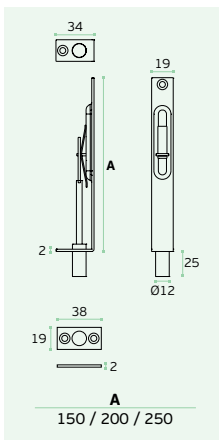

IN.17.615

Material: EN 1.4301
Satinado / Satin / Satin
Fecho / Bolt / Pasador.

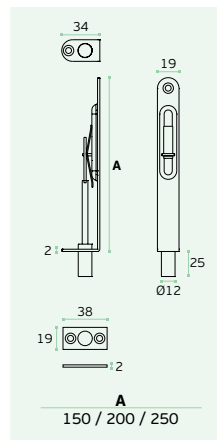

FECHOS / BOLTS / CIERRES.



NEW

IN.17.616

Material: EN 1.4301
Satinado / Satin / Satin
Fecho com indicador de cor /
Slide bolt with color indicator /
Cierre con indicador de color

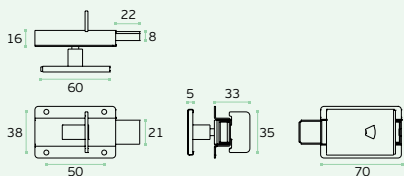

NEW

IN.17.617

Material: EN 1.4301
Satinado / Satin / Satin
Fecho /
Slide bolt /
Cierre.

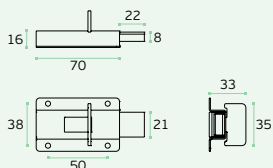

NEW

IN.17.618

Material: EN 1.4301
Satinado / Satin / Satin
Fecho / Bolt / Pasador.

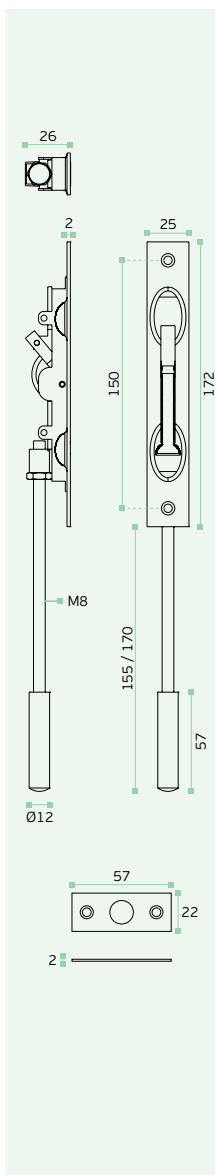



NEW

IN.17.619

Material: EN 1.4301 - Satinado / Satin / Satin
Fecho para porta de correr /
Sliding door latch / Cierre para puertas correderas.

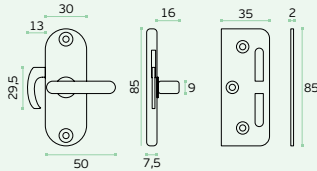

NEW

IN.17.621

Material: EN 1.4301 - Satinado / Satin / Satin
Fecho para cadeado /
Hasp for lock / Cierre para candado.

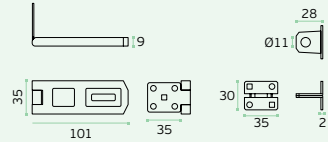

SM.035

Material: EN 1.4301
Satinado / Satin / Satin
Fecho / Bolt / Pasador.

SM.035.P

Polido / Polished / Pulido

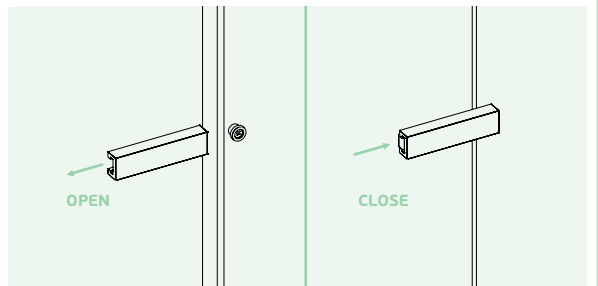
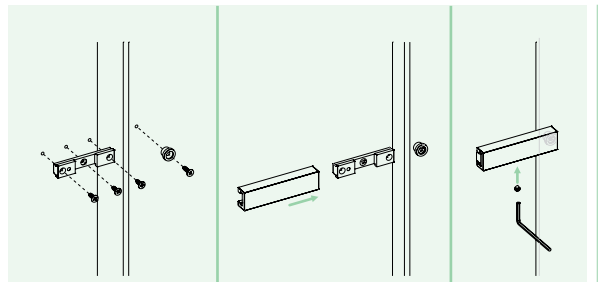
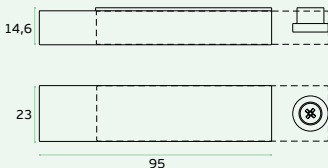

FECHOS / BOLTS / PERCHAS.



IN.17.010

Fecho magnético /

Concealed magnetic latch / Cierre magnetico.

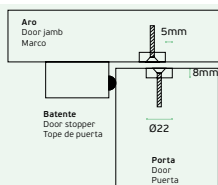

NEW

IN.17.011

Material: EN 1.4301 - Satinado / Satin / Satin

Retentor de porta /

Ball catcher / Retenedor de puerta.

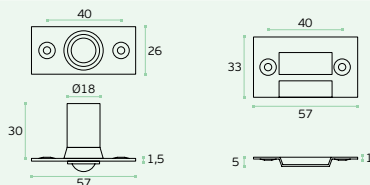

IN.17.400

Material: EN 1.4301 - Satinado / Satin / Satin

Remate para fecho com mola /

Bolt strike with spring /

Cerradero de pasador con muelle.

Aplicável com / Suitable with / Aplicable con:

IN.17.601 / 604 / 605 / 606 / 607 / 609 / 610 / 611

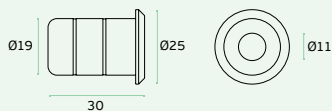

IN.17.401

Material: EN 1.4301 - Satinado / Satin / Satin

Remate para fecho com mola /

Bolt strike with spring /

Cerradero de pasador con muelle.

Aplicável com / Suitable with / Aplicable con:

IN.17.602 / 612 / 614 / 615 / 618

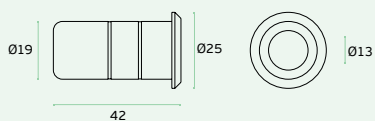



NEW

IN.17.200
Fecho de segurança /
Security latch / Cierre de seguridad.

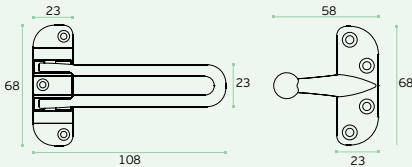

NEW

IN.17.200
Corrente de segurança /
Security chain / Cadena de seguridad.

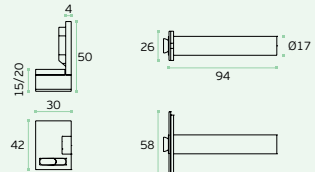

NEW

IN.17.020
Fecho tic tac magnético ajustável /
Adjustable magnetic push open /
Cierre tic tac magnetico ajustable.

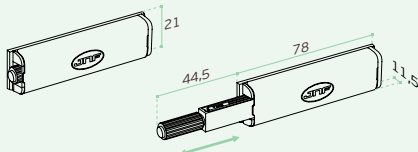

NEW

IN.17.021
Fecho tic tac ajustável /
Adjustable push open /
Cierre tic tac ajustable.

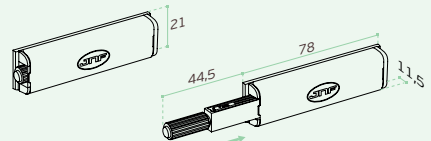

D/554

Ferragens diversas /
General hardware /
Herrajes diversas.

Batente de Porta /
Door Knockers /
Llamadores de Puerta.

www.jnf.pt

BATENTE DE PORTA / DOOR KNOCKERS / LLAMADORES DE PUERTA



IN.24.128

Material: EN 1.4301 - Satinado / Satin / Satin
Batente de porta /
Door knocker / Llamador de puerta.

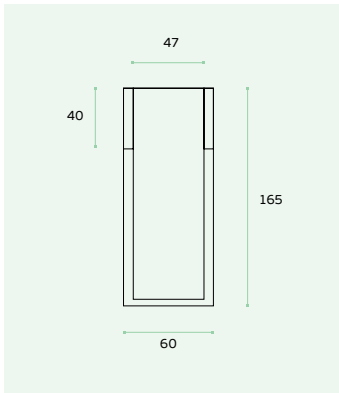

IN.24.129

Material: EN 1.4301 - Satinado / Satin / Satin
Batente de porta /
Door knocker / Llamador de puerta.

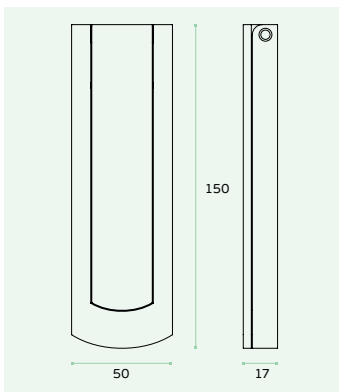

BATENTE DE PORTA / DOOR KNOCKERS / LLAMADORES DE PUERTA

IN.24.126

Material: EN 1.4301 - Satinado / Satin / Satin

Batente de porta /

Door knocker / Llamador de puerta.

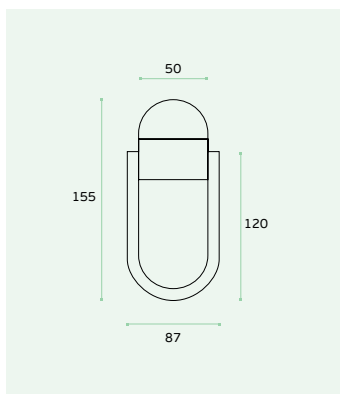

IN.24.127

Material: EN 1.4301 - Satinado / Satin / Satin

Batente de porta /

Door Knockers / Llamador de puerta.

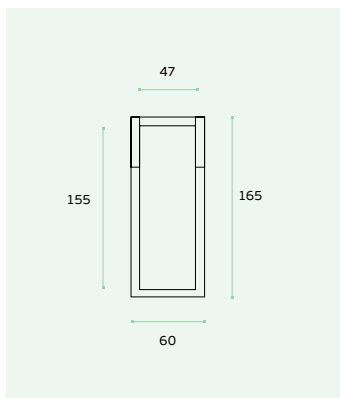

VISOR DE PORTA / DOOR VIEWER / MIRILLA DE PUERTAS.

IN.23.010 LOOK SAFE

Material: EN 1.4301 - Satinado / Satin / Satin
Visor de porta. Lentes de cristal, corpo em aço inox / Door viewer. Cristal lens, stainless steel body / Mirilla de puertas. Lentes en cristal, cuerpo en acero inox.
35 - 50 mm.

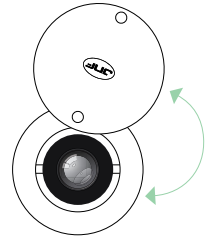
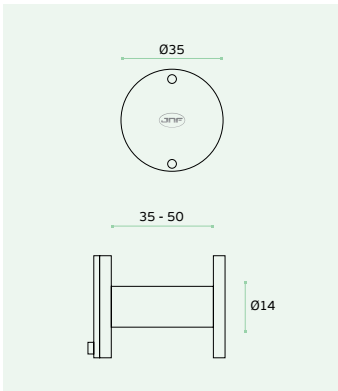

IN.23.010.B LOOK SAFE

Material: EN 1.4301 - Satinado / Satin / Satin
Visor de porta. Lentes de cristal, corpo em aço inox / Door viewer. Cristal lens, stainless steel body / Mirilla de puerta. Lentes en cristal, cuerpo en acero inox.
51 - 80 mm.

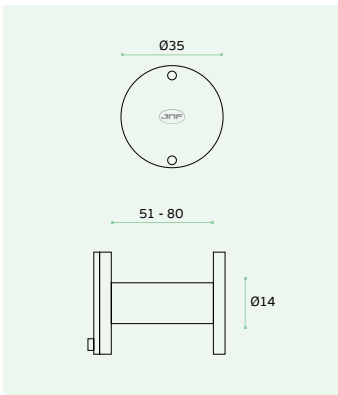

INTERRUPTORES / SWITCHES / INTERRUPTORES.

IN.24.201

Material: EN 1.4301 - Satinado / Satin / Satin
Interruptor / Switch / Interruptor.
12 volt max.

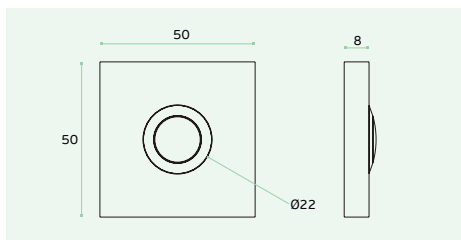

IN.24.202

Material: EN 1.4301 - Satinado / Satin / Satin
Interruptor / Switch / Interruptor.
12 volt max.

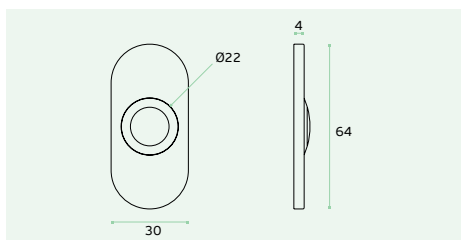

IN.24.203

EN 1.4301 Satinado / Satin / Satin
Interruptor / Switch / Interruptor.
12 volt max.

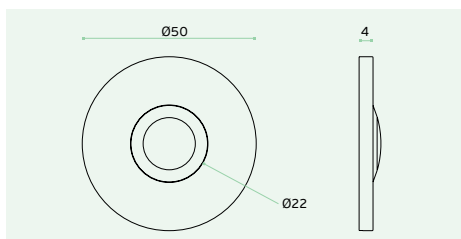

IN.24.204

Material: EN 1.4301 - Satinado / Satin / Satin
Interruptor / Switch / Interruptor.
12 volt max.

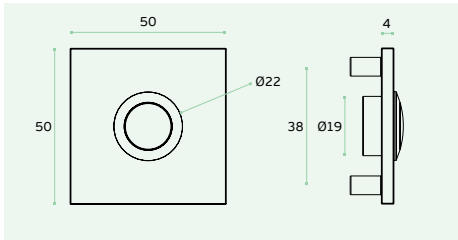

IN.24.205

Material: EN 1.4301 - Satinado / Satin / Satin
Interruptor / Switch / Interruptor.
12 volt max.

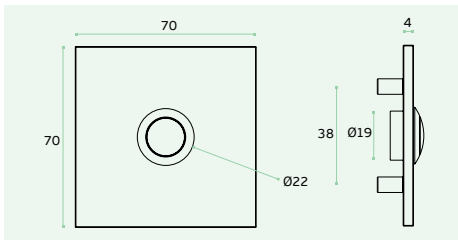

IN.24.206

Material: EN 1.4301 - Satinado / Satin / Satin
Interruptor / Switch / Interruptor.
12 volt max.

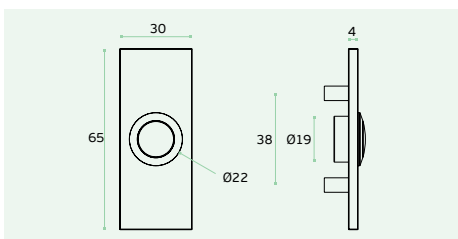

INTERRUPTORES / SWITCHES / INTERRUPTORES.

IN.24.207

Material: EN 1.4301 - Satinado / Satin / Satin
Interruptor / Switch / Interruptor.
12 volt max.

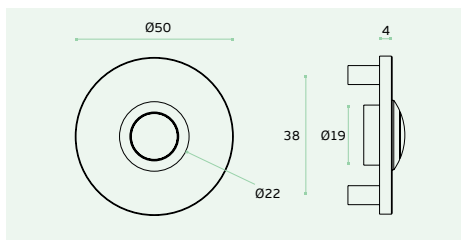

IN.24.208

Material: EN 1.4301 - Satinado / Satin / Satin
Interruptor / Switch / Interruptor.
12 volt max.

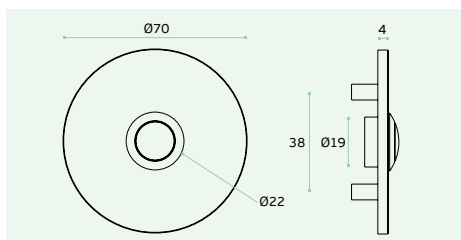

IN.24.209

Material: EN 1.4301 - Satinado / Satin / Satin
Interruptor / Switch / Interruptor.
12 volt max.

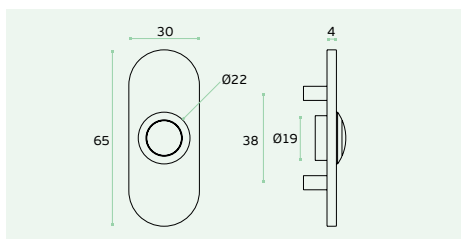

SUPTES DE CORRIMÃO / HAND RAIL SUPPORTS / SOPORTES PASAMANOS.



SUportes de Corrimão / HAND RAIL SUPPORTS / SOPORTES PASAMANOS.

IN.18.130

Material: EN 1.4301 - Satinado / Satin / Satin
Suporte de corrimão /
Hand rail support / Soporte pasamanos.

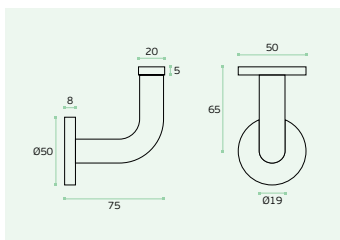

IN.18.131

Material: EN 1.4301 - Satinado / Satin / Satin
Suporte de corrimão /
Hand rail support / Soporte pasamanos.

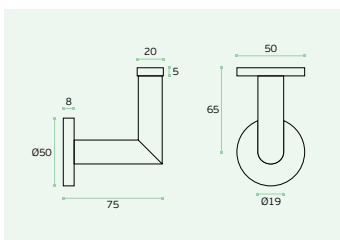

IN.18.133

Material: EN 1.4301 - Satinado / Satin / Satin
Suporte de corrimão /
Hand rail support / Soporte pasamanos.

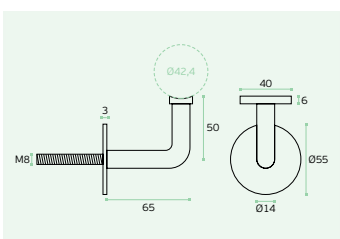

IN.18.134

Material: EN 1.4301 - Satinado / Satin / Satin
Suporte de corrimão com parafuso M8 /
Hand rail support with M8 screw /
Soporte pasamanos con tornillo M8.

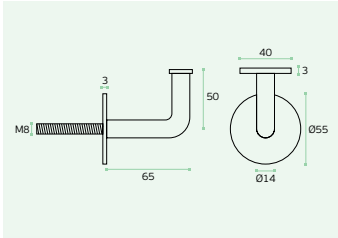

IN.18.135

Material: EN 1.4301 - Satinado / Satin / Satin
Suporte de corrimão para vidro /
Hand rail support for glass /
Soporte pasamanos para cristal.

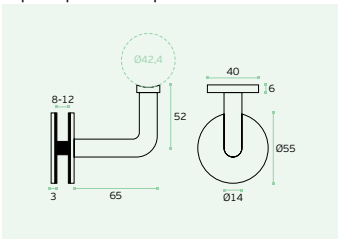

IN.18.136

Material: EN 1.4301 - Satinado / Satin / Satin
Suporte de corrimão para vidro /
Hand rail support for glass /
Soporte pasamanos para cristal.

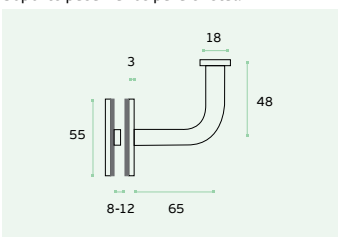

CAIXAS DE CORREIO / MAILBOX / BUZÓN DE CORREO.

IN.24.544

Material: EN 1.4301 - Satinado / Satin / Satin

Caixa de correio em conformidade com a norma europeia EN13724.

Fixação de parede. Pode ser instalada no exterior. Abertura frontal para entrada de correio com tampa de protecção de chuva.

Porta frontal para saída do correio com fechadura.

Fornecido com 2 chaves //

Mailbox designed in accordance with European standard EN13724. Wall fixing. Possible to apply outside. Front opening for incoming mail with a protective cap for rain. Front door with lock to take out the mail. Supplied with 2 keys //

Buzón de correo diseñado de acuerdo con la norma europea EN13724. Sujeción de pared. Posible aplicar en el exterior. Apertura frontal para el correo con una tapa protectora de la lluvia. Puerta de salida de correo con cerradura. Se suministra con 2 llaves.

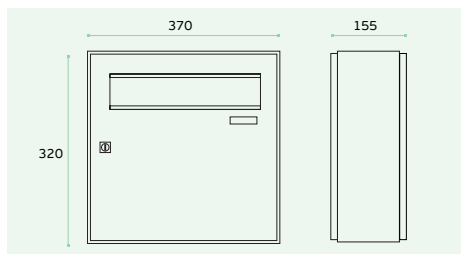
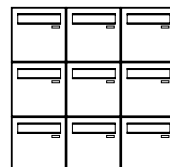

EN13724 1 3 4 1

IN.24.545

Material: EN 1.4301 - Satinado / Satin / Satin

Caixa de correio em conformidade com a norma europeia EN13724.

Possível aplicar no exterior. Abertura frontal para entrada de correio com tampa de protecção de chuva. Porta traseira para saída do correio com fechadura. Fornecido com 2 chaves //

Mailbox designed in accordance with European standard EN13724. Possible to apply outside. Front opening for incoming mail with rain proof. Back door with lock to take out the mail. Supplied with 2 keys //

Buzón de correo diseñado de acuerdo con la norma europea EN13724. Posible aplicar en el exterior. Abertura frontal para el correo con una tapa protectora de la lluvia. Puerta de correo con cerradura. Se suministra con 2 llaves.

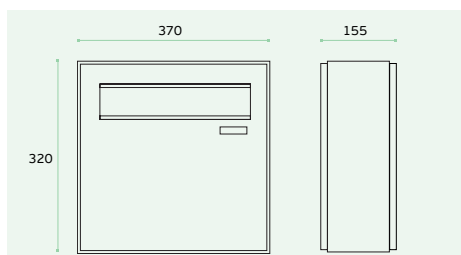
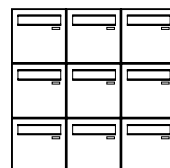



Caixas de Correio /
Mailbox /
Buzón de Correo.

D/565



FRENTE DE CORREIO / LETTER PLATE / FRENTE DE CORREIO.

IN.24.540

Material: EN 1.4301 - Satinado / Satin / Satin

Frente de correio com mola /

Letter plate with spring /

Frente de correio con resorte.

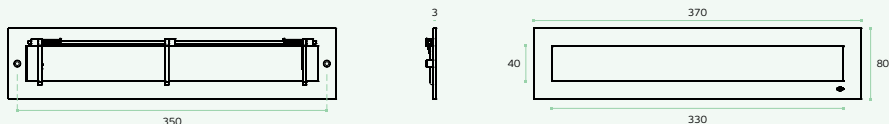
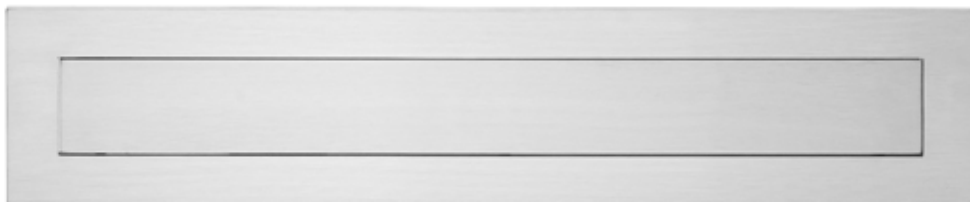

EN13724 41311

IN.24.541

Material: EN 1.4301 - Satinado / Satin / Satin

Frente de correio /

Letter plate / Frente de correio.

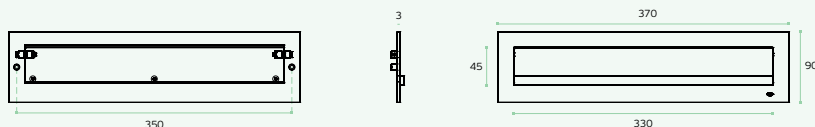

IN.24.542

Material: EN 1.4301 - Satinado / Satin / Satin
Frente de correio /
 Letter plate / Frente de correo.

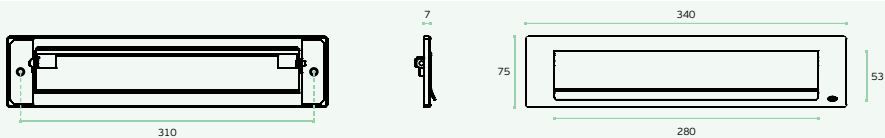

EN13724 **4 2 3 1**

IN.24.547

Material: EN 1.4301 - Satinado / Satin / Satin
Frente de correio com mola /
 Letter plate with spring /
 Frente de correo con resorte.

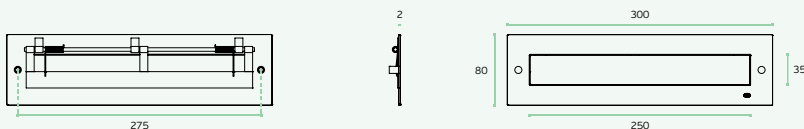
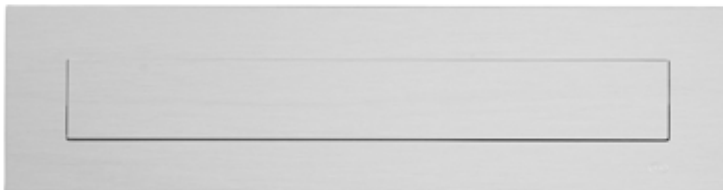

EN13724 **4 2 3 1**

VENTILADORES / VENTILATORS / REJILLAS.

IN.23.033.A

Material: EN 1.4301 - Satinado / Satin / Satin

Ventilador com fixação oculta /

Ventilator with concealed fixing /

Rejilla con sujeción oculta.

IN.23.033.P

Com parafusos/ With screws/ Con tornillos.

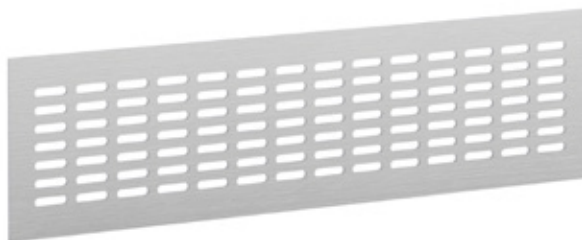
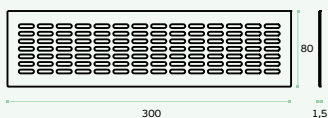

IN.23.034.A

Material: EN 1.4301 - Satinado / Satin / Satin

Ventilador com fixação oculta /

Ventilator with concealed fixing /

Rejilla con sujeción oculta.

IN.23.034.P

Com parafusos/ With screws/ Con tornillos.

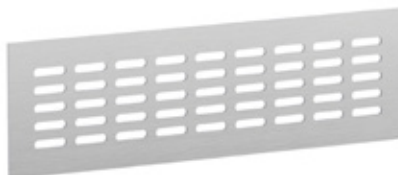
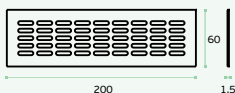

IN.23.035.A

Material: EN 1.4301 - Satinado / Satin / Satin

Ventilador com fixação oculta /

Ventilator with concealed fixing /

Rejilla con sujeción oculta.

IN.23.035.P

Com parafusos/ With screws/ Con tornillos.

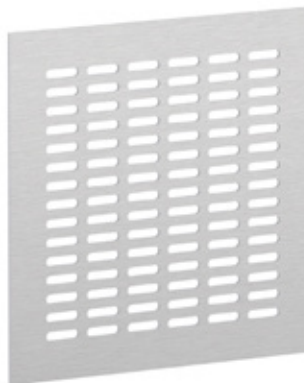
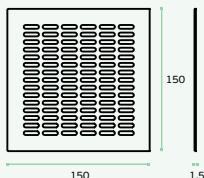

IN.23.033.Q HEAVY DUTY

Material: EN 1.4301 - Satinado / Satin / Satin
Ventilador reforçado com fixação por parafuso. Pode ser aplicado no pavimento /
Reinforced ventilation grid with fixing screws. It can be installed on the floor /
Rejilla reforzada con tornillo de sujeción. Se puede aplicar en el pavimento.

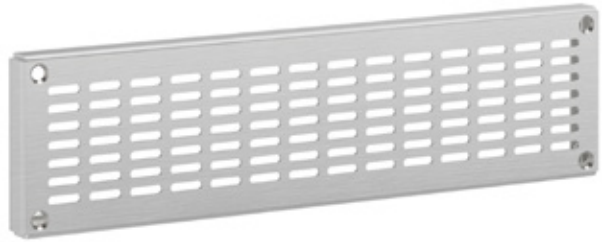
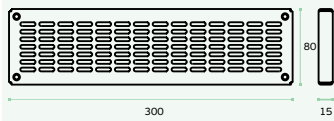

IN.23.034.Q HEAVY DUTY

Material: EN 1.4301 - Satinado / Satin / Satin
Ventilador reforçado com fixação por parafuso. Pode ser aplicado no pavimento /
Reinforced ventilation grid with fixing screws. It can be installed on the floor /
Rejilla reforzada con tornillo de sujeción. Se puede aplicar en el pavimento.

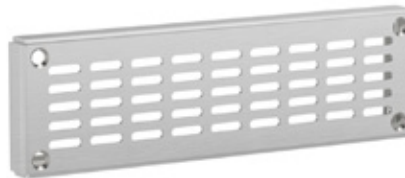
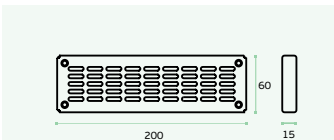

IN.23.035.Q HEAVY DUTY

Material: EN 1.4301 - Satinado / Satin / Satin
Ventilador reforçado com fixação por parafuso. Pode ser aplicado no pavimento /
Reinforced ventilation grid with fixing screws. It can be installed on the floor /
Rejilla reforzada con tornillo de sujeción. Se puede aplicar en el pavimento.

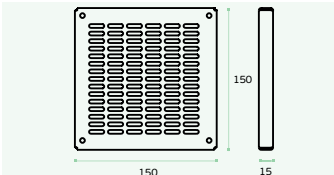

VENTILADORES / VENTILATORS / REJILLAS.

IN.23.028

Material: EN 1.4301 - Satinado / Satin / Satin
Ventilador com fixação por parafuso /
Ventilator with fixing screw /
Rejilla con tornillo de sujeción.

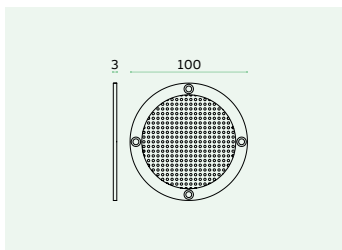

IN.23.029

Material: EN 1.4301 - Satinado / Satin / Satin
Ventilador com fixação por parafuso /
Ventilator with fixing screw /
Rejilla con tornillo de sujeción.

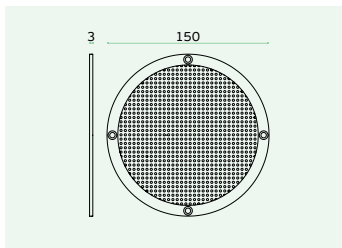

IN.23.030.A

Material: EN 1.4301 - Satinado / Satin / Satin
Ventilador com fixação oculta /
Ventilator with concealed fixing /
Rejilla con sujeción oculta.

IN.23.030.P

Com parafusos/ With screws/ Con tornillos.

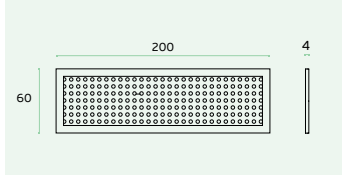

IN.23.031.A

Material: EN 1.4301 - Satinado / Satin / Satin
Ventilador com fixação oculta /
Ventilator with concealed fixing /
Rejilla con sujeción oculta.

IN.23.031.P

Com parafusos/ With screws/ Con tornillos.

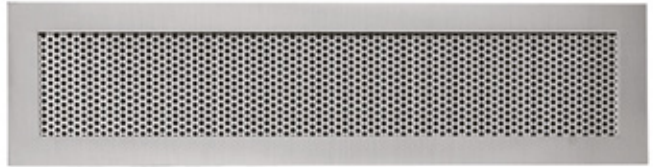
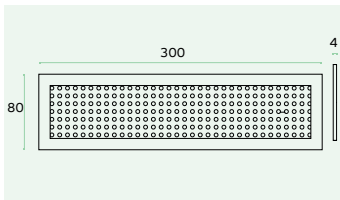

IN.23.032.A

Material: EN 1.4301 - Satinado / Satin / Satin
Ventilador com fixação oculta /
Ventilator with concealed fixing /
Rejilla con sujeción oculta.

IN.23.032.P

Com parafusos/ With screws/ Con tornillos.

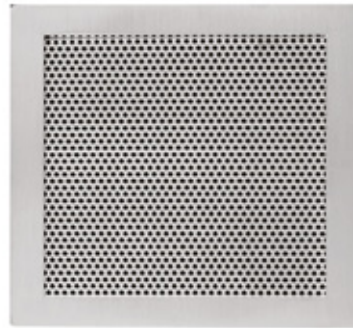
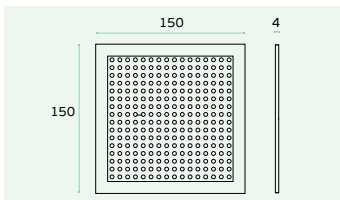

NEW

IN.23.027.40/ IN.23.027.63

Material: EN 1.4301 - Satinado / Satin / Satin
Ventilador com fixação oculta /
Ventilator with concealed fixing /
Rejilla con sujeción oculta.

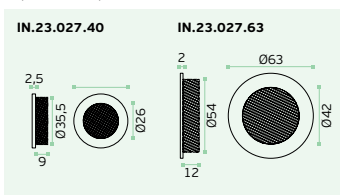

SUORTES PARA PRATELEIRA / SHELF SUPPORTS / SOPORTES PARA BANDEJA.

IN.70.001.200 IN.70.001.250

Material: EN 1.4301 - Satinado / Satin / Satin

Cantoneira reforçada /

Reinforced shelf support / Soporte de bandeja reforzado.

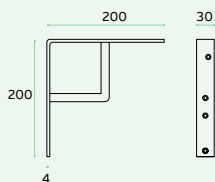

IN.70.001.200

MAX: 20Kg/UNIT

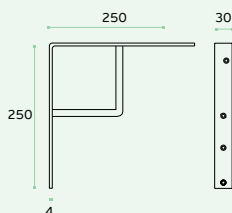

IN.70.001.250

MAX: 20Kg/UNIT

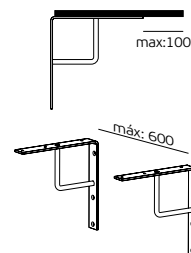

IN.70.001.300 IN.70.001.400

Material: EN 1.4301 - Satinado / Satin / Satin

Cantoneira reforçada /

Reinforced shelf support / Soporte de bandeja reforzado.

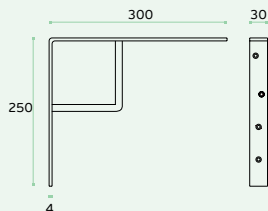

IN.70.001.300

MAX: 20Kg/UNIT

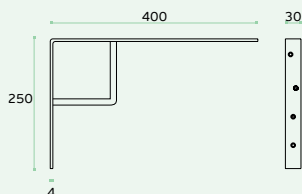

IN.70.001.400

MAX: 20Kg/UNIT

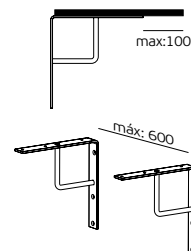

IN.70.100.

Material: EN 1.4301 - Satinado / Satin / Satin
Suportes para prateleira /
Shelf supports / Soportes para bandeja.

REF.	A
IN.70.100.150	150
IN.70.100.200	200
IN.70.100.250	250
IN.70.100.300	300

