

The background of the image is a dark, industrial scene. It features a large, circular grinding wheel in the upper left quadrant, which is in motion, as evidenced by a blurred, glowing orange and white trail of sparks extending from its contact point towards the right. The overall lighting is dim, with the primary light source being the sparks, creating a dramatic, high-contrast effect. The scene suggests a manufacturing or metalworking environment.

A NOX[®]

STAINLESS

PRESTIGE

A close-up photograph of a metal component. The top part shows a large circular hole in a dark metal plate. Below this, a vertical rod or shaft passes through the hole. The bottom part of the image shows a perforated metal surface with several circular holes. The background is dark and out of focus.

ACABAMENTOS DISPONÍVEIS
FINITIONS/FINISHING/ACABADOS

P1 - ANOX

P2 - CHAMPAGNE

P3 - GOLD

P4 - BRONZE

P5 - INOX COLOUR

F0 - EPOXY WHITE

F5 - EPOXY BLACK

P1 - ANOX



5270/405



5260/405



5380/5095



5370/5235



5280/461



5320/5235



976



M1



M5

P2 - CHAMPAGNE



5280/345



5340/405



5380/5095



5350/5095



M11



M14



M12



M18



M4



4



M3



1730/345



5310/405



1700/5095



1710/5235



5270/585



M14



976



M4



5



M2



5290/345



5360/405



1660-18/5095

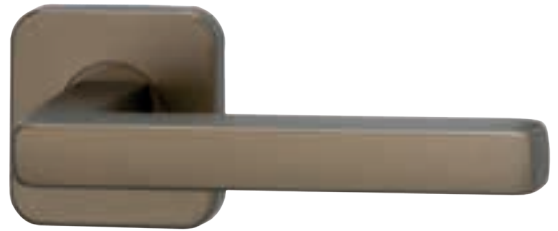

5360/5235



5290/585



5320/5096



3



639



631



5360/405



5300/5095



5360/5235



5320/5095



628



5290/585



M7



M17



5340/345



5290/345



5280/5095



5360/5235



5280/461



643



630



980



110





A NOX[®]
STAINLESS

PRESTIGE

PROGRAMA DISPONÍVEL
RANGE OF PRODUCTS
ARTICULOS DISPONIBLES
ARTICLES DISPONIBLES

urfic®

A♦NOX®
STAINLESS

♦
PRESTIGE



A URFIC® desenvolveu um novo material, tecnologicamente mais avançado, que permite produzir artigos de melhor qualidade e a preços competitivos, cuja resistência é superior a todos os outros materiais.

1. O acabamento de superfície **A♦NOX®** não risca e permite uma protecção com mais de 20 microns, dando uma garantia de superfície totalmente inalterável, mesmo quando aplicado em zonas marítimas, com uma duração mínima entre 30 e 50 anos.
2. O contacto com as mãos no **A♦NOX®** é "quente", por apresentar uma superfície aveludada, muito macia e uniforme, onde se sente o prazer de tocar. Não mancha, mesmo quando aplicado em zonas húmidas.



URFIC® ha desarrollado un nuevo material, tecnologicamente más avanzado, que permite producir artículos de mejor calidad y a precios competitivos, y cuya existencia es superior a todos los demás materiales.

1. El acabado de superficie **A♦NOX®** no marca y ofrece una protección de más de 20 micras, con una garantía de superficie totalmente inalterable, incluso si se aplica en zonas marítimas, y con una duración mínima entre 30 y 50 años.
2. El contacto con las manos en **A♦NOX®** es "caliente", ya que presenta una superficie aterciopelada, suave e uniforme, y cuyo tocar es un placer. No mancha, incluso siendo aplicado en zonas húmedas.



URFIC® a mis au point un nouveaux matériau, technologiquement plus performant, qui permet de fabriquer des articles de meilleure qualité et à des prix compétitifs, dont la résistance est supérieur aux autres matériaux.

1. La finition de surface **A♦NOX®** évite les rayures grâce a une protection de plus de 20 microns, garantissant ainsi une surface totalement inaltérable, même en cas d'utilisation dans des zones maritimes, et une longévité minimale de 30 a 50 ans.
2. **A♦NOX®** dans la main, le contact est chaud, grâce à une surface qui évoque le velours, très douce et uniforme, procurant un réel plaisir au toucher. Cet alliage ne tache pas, même en cas d'utilisation dans des zones humides.



URFIC® have developed a new more advanced technological material. This new material makes it possible to produce items to a higher quality with the added benefit of being able to offer competitive prices.

1. This new A♦NOX® velvet uniform finish is applied to the surface making it warm and smooth to the touch and a pleasure to handle.
2. A♦NOX® as well as looking good it is totally durable with a protection of more than 20 microns. It will not stain or scratch and will keep its excellent finish even in damp and extreme environments such marine and sea areas for a minimum of 30 years and up to 50 years.



URFIC® heeft een nieuw, technologisch zeer geavanceerd productiemateriaal ontwikkeld. Dit nieuwe productiemateriaal maakt het mogelijk om onze producten met een nog hogere kwaliteit dan ooit te produceren, tegen zeer concurrerende prijzen.

1. Neemt u een product uit dit geheel nieuwe A♦NOX® materiaal in de hand, dan voelt het prettig en "warm"aan. Het materiaal ziet er prachtig uit en is tevens bijzonder sterk en krast niet.
2. A♦NOX® ziet er niet alleen goed uit, het is ook bijzonder duurzaam. Met een bescherming van meer dan 20 microns kan het daarom niet krassen en is vlek vrij. Het behoudt zijn excellente finishing, zelfs in vochtige ruimtes en in ons kustgebied.
Wij garanderen onze producten uit A♦NOX® dan ook voor periode van minimaal 30 tot 50 jaar.



URFIC® hat ein neues technisch höher entwickeltes Material hergestellt, das die Produktion von Artikeln in optimaler Qualität zu einem konkurrenzfähigerem Preis ermöglicht. A♦NOX® verfügt über eine höhere Festigkeit als alle anderen bisher verwendeten Materialien.

1. A♦NOX® bietet nicht nur Vorteile im Design. Seine spezielle Oberflächenbeschichtung mit einer Tiefe von 20 Mikron gibt Sicherheit gegen Verkratzen. Dies garantiert eine unveränderliche Oberfläche, selbst bei Einsatz in Meeresnähe und in Regionen mit hoher Schadstoffbelastung der Luft (z. B. Industriezonen).
2. Durch seine samtige und gleichmässige Oberfläche vermittelt A♦NOX® beim Berühren ein angenehmes, weiches Griffgefühl. Das Material ist resistent gegen jegliche Art von Flecken. Selbst beim Einsatz in Feuchträumen und im Aussenbereich tritt bei der Oberfläche auch nach Jahrzehnten **garantiert keine Veränderung** auf.



1650/5265



48/1650/5215



1650/5225



1650/5215



1650/5095



1650/5235



1620/5265



48-1620/5215



1620/5225



1620/5215



1620/5095



1620/5235



1660/5265



48/1660/5215



1660/5225



1660/5215



1660/5095



1660/5235



1670/5265



48/1670/5215



1670/5225



1670/5215



1670/5095



1670/5235



1700/5265



48/1700/5215



1700/5225



1700/5215



1700/5095



1700/5235



1710/5265



48/1710/5215



1710/5225



1710/5215



1710/5095



1710/5235



1720/5265



48/1720/5215



1720/5225



1720/5215



1720/5095



1720/5235



1730/5265



48/1730/5215



1730/5225



1730/5215



1730/5095



1730/5235



5260/5265



48/5260/5215



5260/5225



5260/5215



5260/5095



5260/5235



5270/5265



48/5270/5215



5270/5225



5270/5215



5270/5095



5270/5235



5280/5265



48/5280/5215



5280/5225



5280/5215



5280/5095



5280/5235



5290/5265



48/5290/5215



5290/5225



5290/5215



5290/5095



5290/5235



5300/5265



48/5300/5215



5300/5225



5300/5215



5300/5095



5300/5235



5310/5265



48/5310/5215



5310/5225



5310/5215



5310/5095



5310/5235



5330/5265



48/5330/5215



5330/5225



5330/5215



5330/5095



5330/5235



5340/5265



48/5340/5215



5340/5225



5340/5215



5340/5095



5340/5235



5350/5265



48/5350/5215



5350/5225



5350/5215



5350/5095



5350/5235



5360/5265



48/5360/5215



5360/5225



5360/5215



5360/5095



5360/5235



5370/5265



48/5370/5215



5370/5225



5370/5215



5370/5095



5370/5235



5380/5265



48/5380/5215



5380/5225



5380/5215



5380/5095



5380/5235



1660

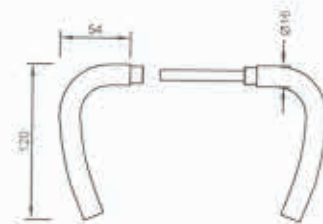

1620

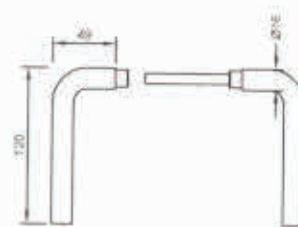

1670

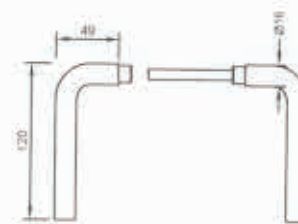

1650

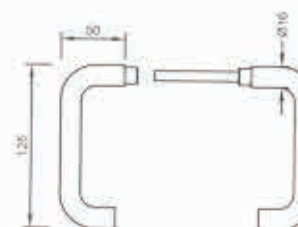



1720

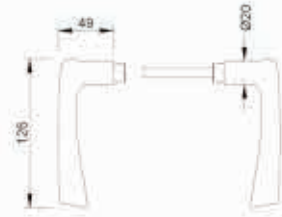

5340

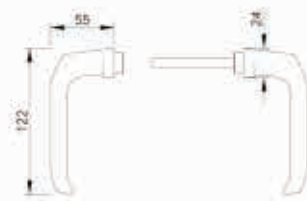

5290

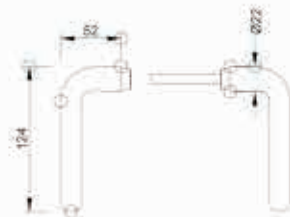

5260

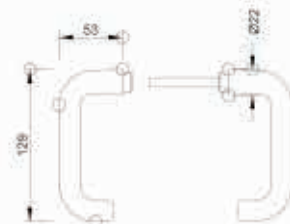



5310

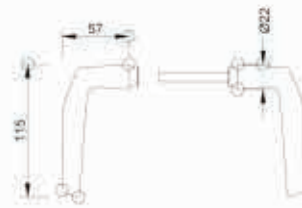

5270

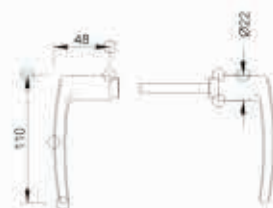

1710

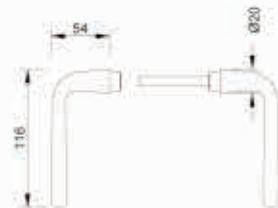

1730

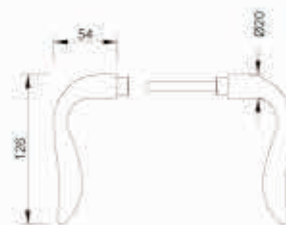



1700

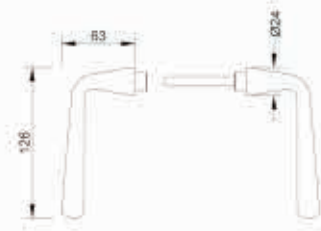

5330

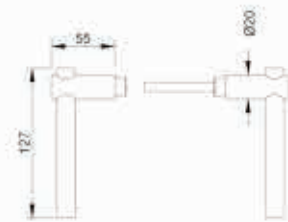

5300

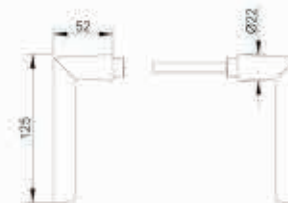

5280

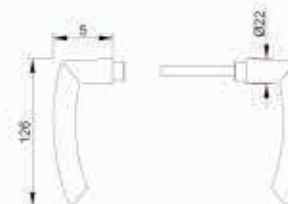



5380

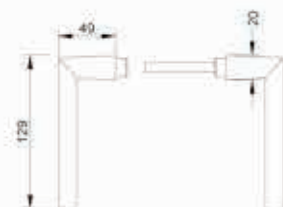

5370

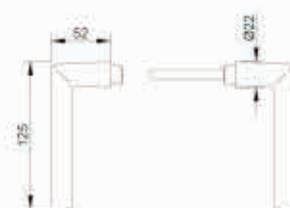

5350

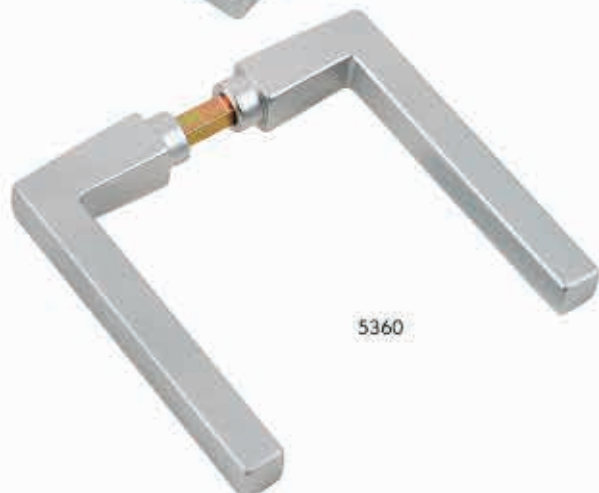
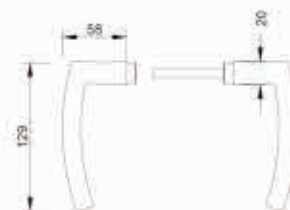

5360

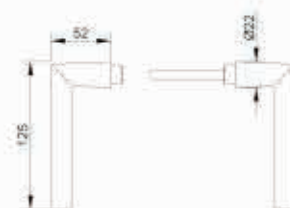



5215-SE



5215-CH



5215-PZ



48/5215



5215-22,3



5215-SF-22,3



5215-SF-CH



5215-SF-PZ



5215-SF-SE



5225-SE



5225-CH



5225-PZ



48/5225



5225-22,3



5225-SF-22,3



5225-SF-CH



5225-SF-PZ



5225-SF-SE



48/5265



5265-22,3



5265-PZ



5265-CH



5265-SE



Holanda (NL)

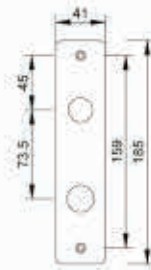
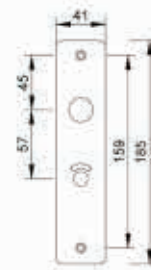
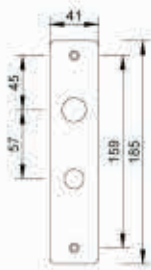
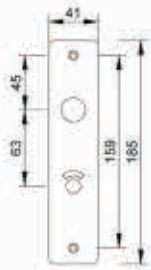
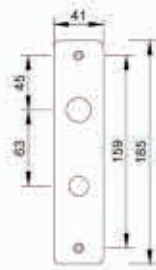
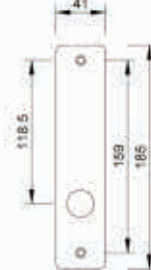
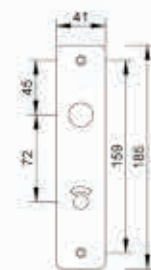
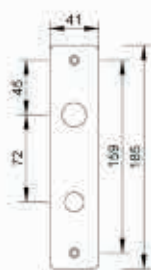
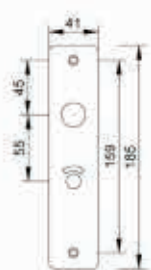
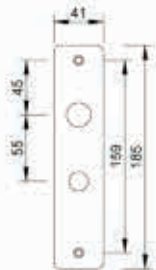
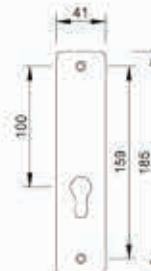
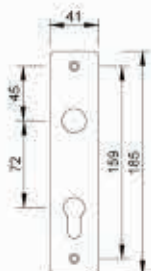
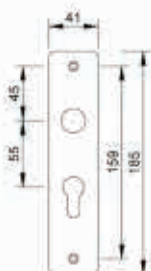
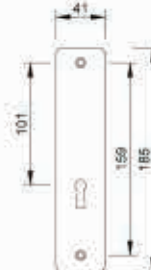
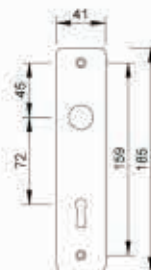
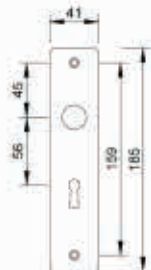
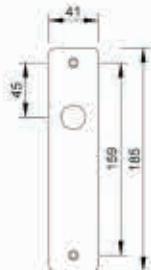

França (F)

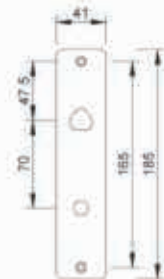
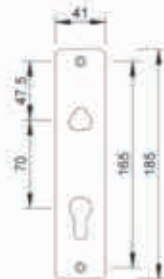
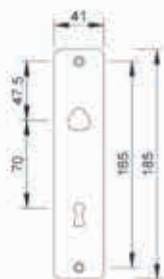

Alemanha (D)

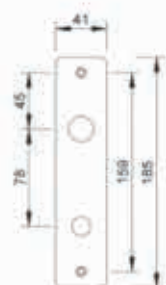
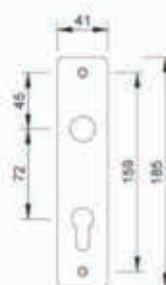

Inglaterra (UK)

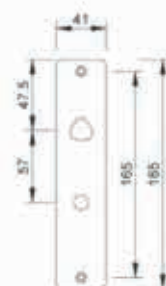
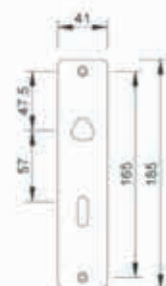

Portugal (PT)

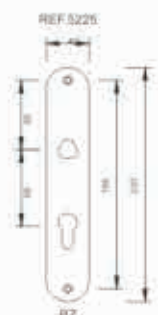
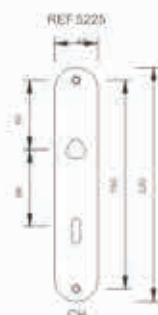



5095-TP



5125



5115



5095



5095-22,3



5235-TP



5245



5255



5235



5235-22,3



61/5095-J



61-5235-J



61/5095



61/5235





5320/5265



5320/5225



5320/5215



5320



5320/5095



5320/5235





555

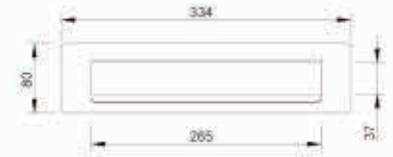

110

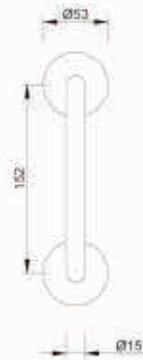
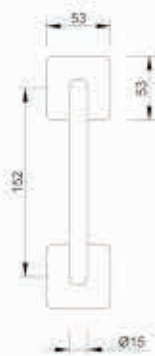
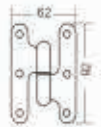
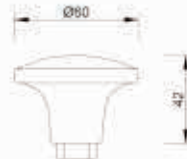

5180/5235



5180/5095



5180/5015



5180/5025



M5/26



M5/22



M5/18

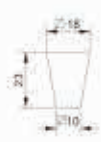

M4/26



M4/22



M4/18



M3/26



M3/22



M3/18



M2/26



M2/22



M2/18



M1/35



M1/30



M1/25



M1/20



M1/15

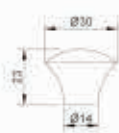



M10/26



M10/22



M10/18



M9/26



M9/22



M9/18



M8/26



M8/22



M8/18



M7/40



M7/35



M7/30

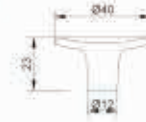

M6/35



M6/30

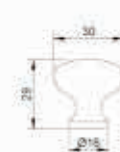



683



682



681

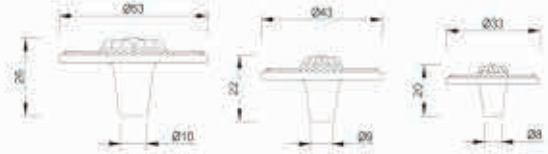

2/35



2/30



2/25



4/35



4/30



4/25



3/35



3/30



3/25



5/35



5/30



5/25





M 11 128-96

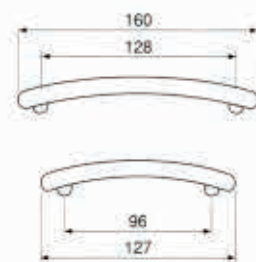

M 12 128-96

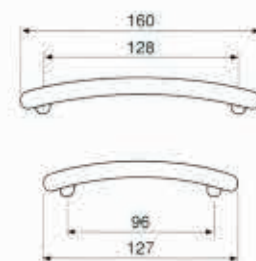

M 13 128-96

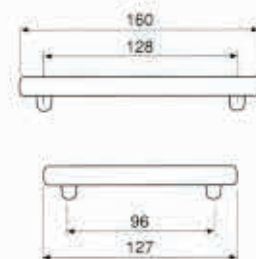

M 14 128-96

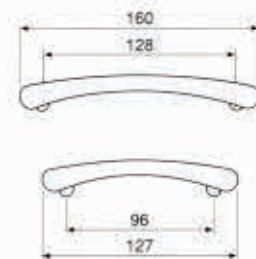



M 15 128-96

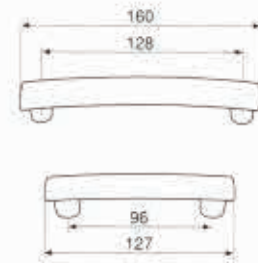

M 16 128-96

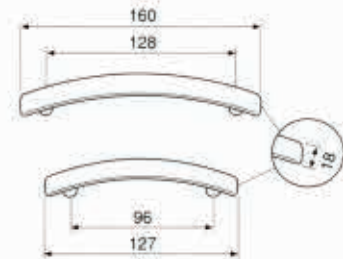

M 17 128-96

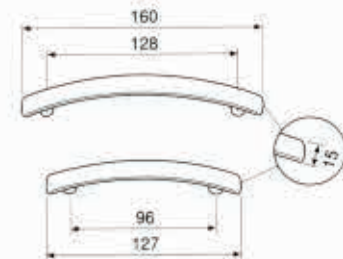

M 18 128-96

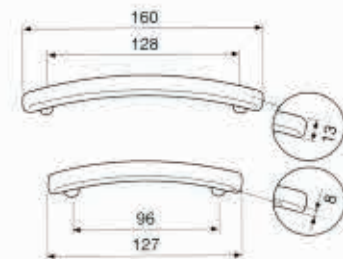



M 19 128-96

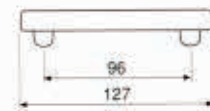
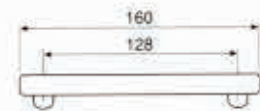

M 20 128-96

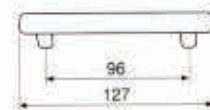
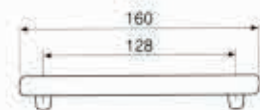

M 21 128-96

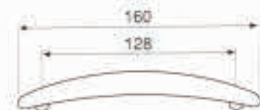

M 22 128-96

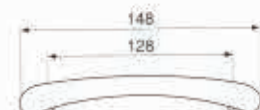



M23/110

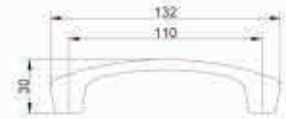

M23/88



M23/73

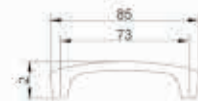

M24/89



M24/76

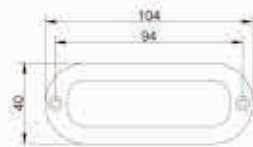
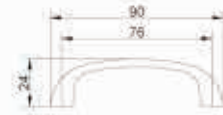

981

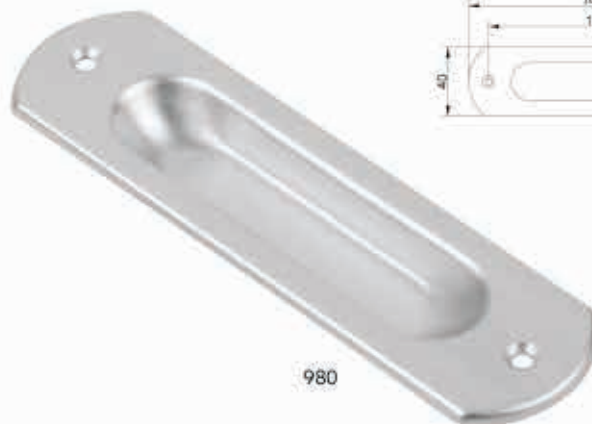

980

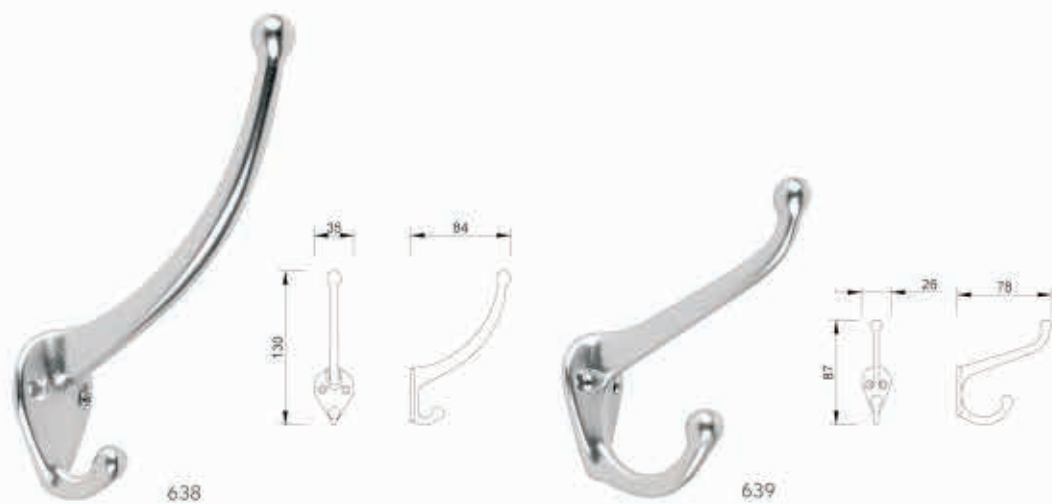
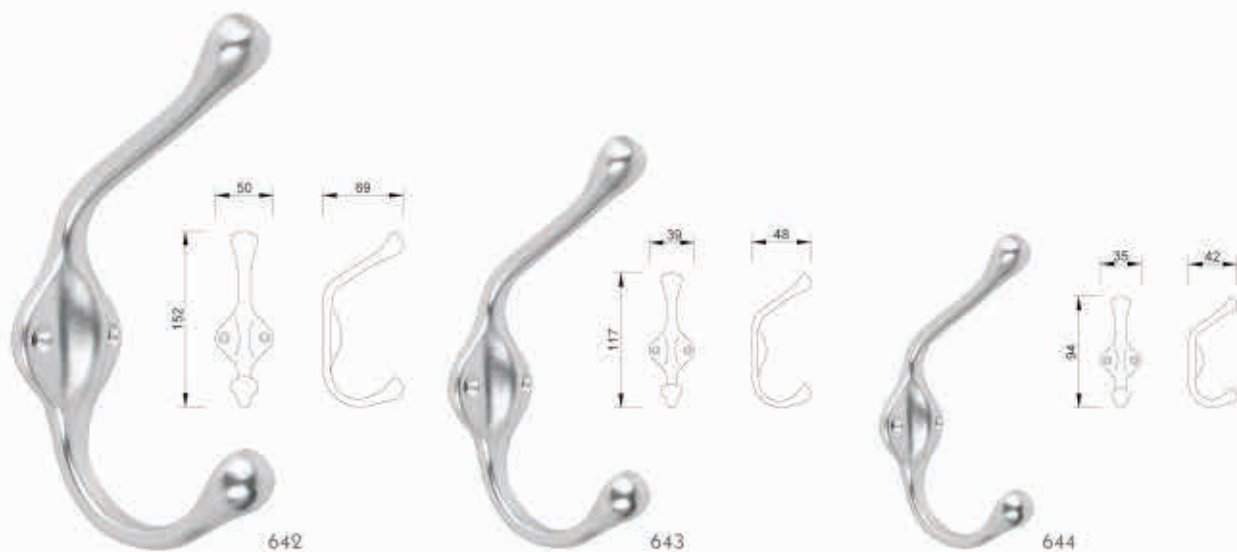

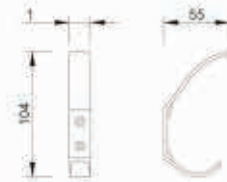
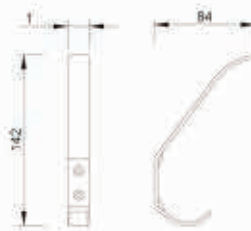
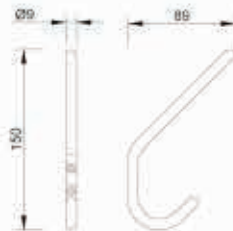
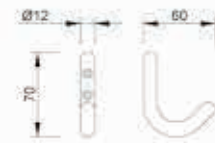



831



832



833



834



835



836



837



838



839



840

urfic[®]

Sede: Rua Eduardo António Coimbra, 319•3460-591 Tondela
Telef. +351 232 814 300•Fax. +351 232 814 301
email:urfic.comercial@sapo.pt
www.urfic.pt

Filial:Rua Ciriaco Cardoso, 489•4150-214 Porto
Telef. +351 226 197 910•Fax. +351 226 106 167
email:urfic@sapo.pt