

KATALOG^{HMT}



HMT Heim + Möbel
Technik GmbH

Möbelschlösser

Möbelschlösser

Design by Stefan Berke, Jasella UG (haftungsbeschränkt) & Co. KG, Schlädchen 6, 51570 Windeck
Druck: DRUCKMÜLLER GmbH, Malsfeldstraße 18, 57539 Roth

Unsere PIKTOGRAMME:



Die Piktogramme:

Bei der Erstellung des vorliegenden Kataloges haben wir den einzelnen Produktgruppen eindeutige Piktogramme zugeordnet.

Diese sollen Ihnen in Verbindung mit der Griffleiste beim Handling helfen, schnell und unkompliziert die gesuchten Artikel zu finden.

Die Bemaßung:

Maßangaben (in Millimetern) an Abbildungen und technische Zeichnungen sind so genau wie möglich, jedoch unverbindlich.

Im Rahmen der Weiterentwicklung unseres Programmes behalten wir uns Änderungen von den Abmessungen, Lochabständen, Ausführungen, Materialien usw. sowie den Fortfall einzelner Artikel ohne besondere Ankündigungen vor.

Wie nehme ich Kontakt auf?

Während der Geschäftszeiten sind unsere Vertriebsmitarbeiter über Telefon, Fax oder E-Mail erreichbar.

HMT Heim + Möbel Technik GmbH
Wecostraße 7
D-53783 Eitorf

Telefon: +49-2243 900 740
Telefax: +49-2243 900 7410

Internet:

www.huwil.com
info@huwil.de



Zylinder und Schlüssel



Stangenschlösser



Hinterlegeschlösser



Einsteck-, Einlass-, Klappen- und Schiebetürschlösser



Spezialschlösser

SUDHAUS®



Zentralverschlüsse



Glasschlösser



Zubehör Schlösser



Elektronikschlösser





Zylinder und Schlüssel

Seite:17

- Wechselzylinder VCS18
- Wechselzylinder TriKey
- Wechselzylinder Z23



Stangenschlösser

Seite:29

- Drehstangenschlösser für Zylinder
- Drehstangenschlösser für Drehknöpfe
- Drehknöpfe für / ohne Zylinder
- Drehstangenschlösser für Bartschlüssel
- Schubstangenschlösser
- Schubstangen / Drehstangen und Zubehör



Hinterlegeschlösser

Seite:63

- Hinterlegeschlösser für Zylinder
- Hinterlegeschlösser für Bartschlüssel



Einsteck-, Einlass-, Klappen- und Schiebetürschlösser

Seite:75

- Einsteck-, Einlassschlösser
- Klappenschlösser
- Schiebetürschlösser



Spezialschlösser

Seite:87

- Hebelriegelschlösser
- Rolljalousieschlösser
- Stahlschlösser
- Zahlenkombinationsschlösser



Zentralverschlüsse

Seite:121

- Zentralverschlüsse
- Zubehör Zentralverschlüsse

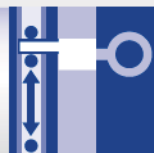

Glasschlösser

Seite:137

- Glasschlösser für Drehtüren
- Glasschlösser mit Drehriegel
- Glasschlösser für Schiebetüren



Zubehör Schlösser

Seite:155

- Rosetten
- Schließbleche und -winkel
- Schlüsselbuchsen und -schilder
- Bartschlüssel



Elektronikschlösser

Seite:177

- Elektronikschlösser
- Sender Elektronikschlösser



Artikel-Nr. Verzeichnis

Ein Verzeichnis der **ehemaligen** Artikelnummern finden Sie auf Seite 12

Artikel-Nr.	Seite	Artikel-Nr.	Seite	Artikel-Nr.	Seite	Artikel-Nr.	Seite
11.0060.VNS.0123	19	12.0248.KNU.0000	32	12.0700.KNU.0030	46	12.1237.ZNE.0800	60
11.0060.VNS.0999	19	12.0248.KNU.0015	32	12.0710.ZBL.0468	47	12.1237.ZNE.0800	133
11.0060.VNS.3131	19	12.0248.KNU.0020	32	12.0710.ZBR.0467	47	12.1237.ZNE.1000	60
11.0065.VNS.0123	19	12.0248.KNU.0025	32	12.0710.ZNL.0468	47	12.1237.ZNE.1500	60
11.0065.VNS.0999	19	12.0248.KNU.0030	32	12.0710.ZNR.0467	47	12.1262.ZBL.0142	49
11.0065.VNS.3131	19	12.0292.PND.0007	59	12.0710.ZSO.0464	50	12.1262.ZBL.0284	49
11.0077.VNG.0504	23	12.0292.PND.0007	132	12.0719.ZBL.0468	48	12.1262.ZBR.0141	49
11.0171.PNG.1800	28	12.0292.PNL.0006	59	12.0719.ZBR.0467	48	12.1262.ZBR.0283	49
11.0171.PNH.1800	27	12.0292.PNR.0005	59	12.0719.ZNL.0468	48	12.1262.ZNL.0084	49
11.0171.PNH.1850	27	12.0292.VND.0007	59	12.0719.ZNR.0467	48	12.1262.ZNL.0264	49
11.0500.VNO.0010	24	12.0292.VND.0007	132	12.0722.ZUO.0000	46	12.1262.ZNL.0402	49
11.1550.VNZ.0018	19	12.0292.VNL.0006	59	12.0724.ZSL.0053	55	12.1262.ZNR.0083	49
11.1550.VNZ.0019	21	12.0292.VNR.0005	59	12.0724.ZUR.0002	55	12.1262.ZNR.0263	49
11.1550.VNZ.0999	19	12.0292.ZNO.0370	61	12.0740.ZBL.1623	48	12.1262.ZNR.0401	49
11.1551.VNH.0001	23	12.0292.ZNO.0410	60	12.0740.ZBO.0652	51	12.1264.ZBL.0004	50
11.1555.VNC.0103	21	12.0441.PNL.0006	34	12.0740.ZBR.1613	48	12.1264.ZBL.0014	50
11.1555.VNF.0027	21	12.0441.PNR.0005	34	12.0740.ZNL.1623	48	12.1264.ZBR.0003	50
11.1577.VNZ.0001	23	12.0442.PNN.1900	39	12.0740.ZNO.0652	51	12.1264.ZBR.0013	50
11.1587.VNH.0001	23	12.0444.FNO.0000	40	12.0740.ZNR.1613	48	12.1264.ZNL.0012	50
11.1588.VNG.0001	24	12.0471.PNL.0006	34	12.0740.ZWO.7110	46	12.1264.ZNL.0052	50
11.1590.FNZ.0018	24	12.0471.PNR.0005	34	12.0749.ZBL.1621	48	12.1264.ZNR.0011	50
11.1823.PNF.0123	26	12.0472.PNN.1900	39	12.0749.ZBO.0710	51	12.1264.ZNR.0051	50
11.1823.PNF.5123	26	12.0474.FNO.0000	40	12.0749.ZBR.1611	48	12.1337.ZNO.0001	53
11.1823.PNZ.0123	26	12.0500.PIO.0000	34	12.0749.ZNL.1621	48	12.1338.ZNO.0004	53
11.1823.PNZ.1111	26	12.0568.FNO.8871	39	12.0749.ZNO.0710	51	12.1338.ZNO.0023	54
11.1823.PNZ.5123	26	12.0568.KNU.0401	36	12.0749.ZNR.1611	48	12.1339.ZBO.0009	54
11.5002.PNC.0123	27	12.0568.VNL.0002	35	12.0750.PNU.0000	31	12.1339.ZZO.0001	54
11.5002.PNC.5123	27	12.0568.VNR.0001	35	12.0750.PNU.0015	31	12.1357.ZNO.0001	54
11.5289.PNF.0123	27	12.0568.VNU.0601	35	12.0750.PNU.0020	31	12.2211.ZNO.0430	62
11.5289.PNF.5123	27	12.0571.FNO.8902	39	12.0750.PNU.0025	31	12.2618.ZKO.0003	56
11.9219.PNZ.4000	26	12.0571.KNU.0401	36	12.0750.PNU.0030	31	12.6516.ZZO.0019	41
11.9289.PNZ.0123	26	12.0571.VNL.0002	35	12.0750.VNU.0000	31	12.8871.ZNO.0001	36
11.9289.PNZ.5123	26	12.0571.VNR.0001	35	12.0750.VNU.0015	31	12.8871.ZNO.0100	37
11.9299.PNA.1800	28	12.0571.VNU.0601	36	12.0750.VNU.0020	31	12.9018.ZNO.0071	41
12.0204.PNL.0002	58	12.0700.BBL.0000	44	12.0750.VNU.0025	31	12.9080.ZNO.0001	41
12.0204.PNR.0001	58	12.0700.BBL.0015	44	12.0750.VNU.0030	31	12.9081.ZNO.0001	40
12.0204.VNL.0002	58	12.0700.BBL.0020	44	12.0750.ZBO.0570	53	13.0192.VNO.0501	68
12.0204.VNR.0501	58	12.0700.BBL.0025	44	12.0750.ZKO.0520	54	13.0391.PND.0020	64
12.0204.VNR.0511	58	12.0700.BBL.0030	44	12.0750.ZNO.0510	52	13.0391.PNL.0020	64
12.0205.VNR.0501	58	12.0700.BBR.0000	44	12.0750.ZNO.0540	52	13.0391.PNR.0020	64
12.0207.VNO.0501	59	12.0700.BBR.0015	44	12.0750.ZNO.0550	52	13.0405.BBU.0015	69
12.0207.VNO.0551	59	12.0700.BBR.0020	44	12.0750.ZNO.0570	53	13.0405.BBU.0020	69
12.0210.KNU.0551	37	12.0700.BBR.0025	44	12.0750.ZNO.0580	53	13.0405.BBU.0025	69
12.0213.KNL.0502	37	12.0700.BBR.0030	44	12.0863.ZSO.0003	61	13.0405.BBU.0030	69
12.0213.KNR.0501	37	12.0700.BNL.0000	45	12.1176.ZSO.0003	62	13.0405.BBU.0035	69
12.0235.KNU.0015	45	12.0700.BNL.0015	45	12.1176.ZSO.0003	159	13.0405.BBU.0040	69
12.0236.BBU.0000	43	12.0700.BNL.0020	45	12.1211.ZNO.0001	61	13.0405.BBU.0040	69
12.0236.BBU.0015	43	12.0700.BNL.0025	45	12.1224.ZBO.0014	51	13.0405.BBU.0040	69
12.0236.BBU.0020	43	12.0700.BNL.0030	45	12.1224.ZNO.0011	51	13.0405.BBU.0040	69
12.0236.BBU.0025	43	12.0700.BNR.0000	44	12.1225.ZBO.0014	52	13.0405.BBU.0040	69
12.0236.BBU.0030	43	12.0700.BNR.0015	44	12.1225.ZNO.0011	52	13.0405.BBU.0040	69
12.0236.BBU.0030	43	12.0700.BNR.0020	44	12.1232.ZBO.1000	47	13.0405.BBU.0040	69
12.0236.BBU.0030	43	12.0700.BNR.0025	44	12.1232.ZBO.1200	47	13.0425.FNL.0009	64
12.0236.BBU.0030	43	12.0700.BNR.0030	44	12.1232.ZBO.2000	47	13.0425.FNR.0009	64
12.0236.BNU.0000	43	12.0700.BNR.0030	44	12.1232.ZNO.1000	47	13.0425.VND.0020	64
12.0236.BNU.0015	43	12.0700.KBU.0000	45	12.1232.ZNO.1200	47	13.0425.VNL.0020	64
12.0236.BNU.0020	43	12.0700.KBU.0015	45	12.1232.ZNO.2000	47	13.0425.VNR.0020	64
12.0236.BNU.0025	43	12.0700.KBU.0020	45	12.1233.ZNO.1200	47	13.0426.BBL.0015	70
12.0236.BNU.0030	43	12.0700.KBU.0025	45	12.1233.ZNO.2000	47	13.0426.BBL.0030	70
12.0238.ZSU.3001	55	12.0700.KBU.0030	45	12.1237.ZNB.0600	60	13.0426.BBR.0015	70
12.0238.ZUU.4001	55	12.0700.KNU.0000	46	12.1237.ZNB.1000	60	13.0426.BBR.0030	70
12.0247.VNU.0000	31	12.0700.KNU.0015	46	12.1237.ZNE.0600	60	13.0426.BNL.0015	70
12.0247.VNU.0015	31	12.0700.KNU.0020	46	12.1237.ZNE.0600	133	13.0426.BNL.0020	70
12.0247.VNU.0020	31	12.0700.KNU.0025	46				
12.0247.VNU.0025	31						
12.0247.VNU.0030	31						

Artikel-Nr. Verzeichnis

Ein Verzeichnis der **ehemaligen** Artikelnummern finden Sie auf Seite 12

Artikel-Nr.	Seite	Artikel-Nr.	Seite	Artikel-Nr.	Seite	Artikel-Nr.	Seite
13.0426.BNL.0025	70	14.0490.BML.0030	77	15.0315.PNR.0020	114	15.0829.FNO.0555	89
13.0426.BNL.0030	70	14.0490.BML.0035	77	15.0315.PNR.0025	114	15.0829.ZNO.0003	90
13.0426.BNR.0015	70	14.0490.BML.0040	77	15.0316.PNR.0015	114	15.0829.ZNO.0003	147
13.0426.BNR.0020	70	14.0490.BMR.0015	76	15.0316.PNR.0020	114	15.0829.ZNO.2001	90
13.0426.BNR.0025	70	14.0490.BMR.0020	76	15.0316.PNR.0025	114	15.0829.ZZO.0004	90
13.0426.BNR.0030	70	14.0490.BMR.0025	76	15.0358.VNL.0015	102	15.0849.VSL.0504	109
13.0429.BBL.0012	69	14.0490.BMR.0030	76	15.0358.VNR.0015	102	15.0849.VSR.0501	109
13.0429.BBR.0012	69	14.0490.BMR.0035	76	15.0358.ZNL.1146	102	15.0849.VSR.0502	109
13.0431.PND.0010	65	14.0490.BMR.0040	76	15.0358.ZNO.1147	102	15.0849.VSR.0532	109
13.0431.PNL.0010	65	14.0490.ZMO.8012	77	15.0358.ZNO.1149	103	15.0868.VNO.3423	89
13.0431.PNR.0010	65	14.0501.PNO.2005	80	15.0358.ZNR.1146	102	15.0868.ZZO.1021	90
13.0489.VNR.0036	68	14.0514.PNO.2005	84	15.0359.VNL.0015	102	15.0869.ZNG.0037	98
13.0489.VNR.0069	68	14.0514.ZNO.3014	84	15.0359.VNR.0015	102	15.0869.ZNG.0037	148
13.0530.BBL.0012	71	14.0514.ZNO.3014	161	15.0371.ZNG.0037	96	15.0869.ZNG.0049	98
13.0530.BBL.0015	71	14.0515.PNO.2005	85	15.0371.ZNG.0037	117	15.0869.ZNG.0049	148
13.0530.BBL.0020	71	14.0515.VNO.7001	85	15.0371.ZNG.4720	95	15.0869.ZNK.0032	97
13.0530.BBL.0025	71	14.0521.PNO.2005	80	15.0371.ZNK.0030	94	15.0869.ZNK.0037	97
13.0530.BBL.0030	71	14.0521.ZNO.0022	81	15.0371.ZNK.0037	95	15.0869.ZNK.0052	97
13.0530.BBR.0012	71	14.0521.ZNO.0022	157	15.0371.ZNK.0037	117	15.0869.ZNK.0052	147
13.0530.BBR.0015	71	14.0792.VNO.0501	80	15.0371.ZNK.0041	95	15.0869.ZNK.0057	97
13.0530.BBR.0020	71	14.0792.VNO.0601	80	15.0371.ZNK.0042	94	15.0869.ZNK.0057	148
13.0530.BBR.0025	71	14.0793.VNO.0501	83	15.0371.ZNK.0047	94	15.0873.VNO.0520	111
13.0530.BBR.0030	71	14.0793.VNO.0502	83	15.0371.ZNK.4150	95	15.0873.VNR.0514	111
13.0530.BNL.0012	71	14.0793.VNO.0503	83	15.0375.PNL.4025	91	15.0873.VNR.0551	111
13.0530.BNL.0015	71	14.0796.VNO.0551	84	15.0375.PNR.4025	91	15.0873.ZFO.1000	111
13.0530.BNL.0020	71	14.0797.VNO.0531	85	15.0416.PNL.0015	105	15.0873.ZNO.1011	111
13.0530.BNL.0025	71	14.0797.VNO.0531	109	15.0416.PNL.0022	105	15.0875.VNR.0501	111
13.0530.BNL.0030	71	14.1288.ZNO.0001	83	15.0416.PNL.1015	105	15.0880.VNO.0501	113
13.0530.BNR.0012	70	14.1288.ZNO.0001	156	15.0416.PNL.1022	105	15.1147.KSL.0001	118
13.0530.BNR.0015	70	15.0057.KSL.2401	117	15.0416.PNR.0015	105	15.1147.KSR.0001	118
13.0530.BNR.0020	70	15.0057.KSL.2434	117	15.0416.PNR.0022	105	15.1153.KSL.0001	119
13.0530.BNR.0025	70	15.0057.KSL.3401	117	15.0416.PNR.1015	105	15.1153.KSL.0002	119
13.0530.BNR.0030	70	15.0057.KSL.3434	117	15.0416.PNR.1022	105	15.1153.KSR.0001	119
13.0550.PNU.0015	65	15.0057.KSR.2401	116	15.0416.PNL.0015	105	15.1153.KSR.0002	119
13.0550.PNU.0020	65	15.0057.KSR.2434	116	15.0416.VNL.0022	105	15.1157.KSL.0001	119
13.0550.PNU.0025	65	15.0057.KSR.3401	116	15.0416.VNL.1015	106	15.1157.KSR.0001	119
13.0550.PNU.0030	65	15.0057.KSR.3434	116	15.0416.VNL.1022	106	15.1157.ZSO.0802	119
13.0550.VNU.0015	65	15.0057.ZIO.0504	118	15.0416.VNR.0015	105	15.1157.ZSO.0802	119
13.0550.VNU.0020	65	15.0057.ZNO.0001	118	15.0416.VNR.0022	105	15.1157.ZSO.0802	119
13.0550.VNU.0025	65	15.0057.ZNO.0034	118	15.0416.VNR.1015	106	15.1157.ZSO.0815	119
13.0550.VNU.0030	65	15.0133.VNO.0000	98	15.0416.VNR.1022	106	15.1157.ZSO.0815	119
13.0584.PNL.0025	67	15.0133.VNR.0015	98	15.0416.ZNO.4161	106	15.1157.ZSO.0815	119
13.0584.PNR.0025	67	15.0133.ZNO.1181	99	15.0416.ZNO.4165	106	15.1168.KGR.0001	120
13.0584.VNL.0025	67	15.0170.VNO.0000	99	15.0512.PNR.2005	109	15.1168.KGR.0002	120
13.0584.VNR.0025	67	15.0170.VNR.0022	99	15.0827.VNO.0601	89	15.1168.KSR.0001	120
13.0587.KNU.0025	73	15.0171.VNR.0022	101	15.0827.ZNG.0025	91	15.1168.KSR.0002	120
13.0660.PNU.1540	67	15.0171.ZNO.1070	101	15.0827.ZNG.0030	96	15.1844.KGL.0001	120
13.0660.VNU.1540	67	15.0171.ZNO.1180	101	15.0827.ZNG.0032	91	15.1844.KGR.0001	120
13.1182.ZNO.0001	68	15.0171.ZNO.1181	101	15.0827.ZNG.0033	91	15.1844.KNL.0001	120
13.5107.KNO.0032	73	15.0301.PNR.0015	113	15.0827.ZNG.0036	94	15.1844.KNR.0001	120
14.0355.BBD.0183	77	15.0301.PNR.0020	113	15.0827.ZNG.0037	92	15.1844.ZSO.0802	120
14.0355.BBL.0182	77	15.0302.PNR.0015	113	15.0827.ZNG.0042	93	15.1844.ZSO.0815	120
14.0355.BBR.0181	77	15.0302.PNR.0020	113	15.0827.ZNG.0051	92	16.0042.ZUA.0462	126
14.0393.VND.5007	79	15.0310.ZGO.1902	115	15.0827.ZNG.0052	92	16.0042.ZUI.0462	126
14.0393.VND.5042	79	15.0310.ZKO.1904	114	15.0827.ZNG.2052	93	16.0292.ZSO.0411	133
14.0393.VND.5227	79	15.0310.ZUO.3028	115	15.0827.ZNK.0033	92	16.0429.PNR.0038	129
14.0393.VND.5235	79	15.0311.PNR.0015	114	15.0827.ZNK.0034	93	16.0430.PNR.0000	130
14.0393.VND.5257	79	15.0311.PNR.0020	114	15.0827.ZNK.0043	93	16.0430.VNR.0000	132
14.0394.VNO.0501	79	15.0311.PNR.0025	114	15.0827.ZNK.0046	96	16.0471.PNR.2035	127
14.0394.VNO.0502	79	15.0312.PNR.0015	114	15.0827.ZNL.0037	96	16.0906.ZUO.0010	135
14.0490.BML.0015	77	15.0312.PNR.0020	114	15.0827.ZNR.0037	96	16.0906.ZUO.0012	135
14.0490.BML.0020	77	15.0312.PNR.0025	114	15.0827.ZNR.0037	118	16.0906.ZUO.0013	135
14.0490.BML.0025	77	15.0315.PNR.0015	114	15.0829.FNO.0123	89	16.0906.ZUO.0016	135

Artikel-Nr. Verzeichnis

Ein Verzeichnis der **ehemaligen** Artikelnummern finden Sie auf Seite 12

Artikel-Nr.	Seite	Artikel-Nr.	Seite	Artikel-Nr.	Seite	Artikel-Nr.	Seite
16.0906.ZUO.0025	135	17.0320.VND.0036	140	17.0687.VNU.5452	150	18.1354.ZKB.0001	159
16.0906.ZUO.0031	135	17.0320.VNK.0016	140	17.0689.VNL.0123	138	18.1354.ZKW.0002	159
16.0912.ZUO.0008	135	17.0320.VNK.0036	140	17.0689.VNL.0555	138	18.1360.ZMO.0002	160
16.0912.ZUO.0012	135	17.0320.VNL.1020	140	17.0689.VNR.0123	138	18.1360.ZNO.0003	160
16.0912.ZUO.0016	135	17.0320.VNR.0016	140	17.0689.VNR.0555	138	18.1408.BNM.0035	167
16.0912.ZUO.0020	135	17.0320.VNR.0036	140	17.0690.VNL.0123	138	18.1409.BBD.0025	167
16.0912.ZUO.0025	135	17.0320.VNR.1020	140	17.0690.VNL.0555	138	18.1409.BBD.0035	167
16.0912.ZUO.0031	135	17.0320.ZNO.0120	146	17.0690.VNR.0123	138	18.1410.BMO.0045	168
16.0916.ZZC.0600	127	17.0321.PND.0016	142	17.0690.VNR.0555	138	18.1410.BMO.0055	168
16.0916.ZZC.1000	127	17.0321.PND.0036	142	17.0691.VNL.3123	138	18.1410.BNM.0040	168
16.0922.VNB.0025	123	17.0321.PNK.0016	142	17.0691.VNL.3555	138	18.1410.BNM.0045	168
16.0922.VNB.0032	123	17.0321.PNK.0036	142	17.0691.VNL.4123	138	18.1410.BNM.0055	168
16.0922.VNB.0040	123	17.0321.PNL.1020	142	17.0691.VNL.4555	138	18.1413.BNM.0035	168
16.0922.VNB.0045	123	17.0321.PNR.0016	142	17.0691.VNR.1123	138	18.1425.BNM.0040	168
16.0922.VNB.0050	123	17.0321.PNR.0036	142	17.0691.VNR.1555	138	18.1427.BBO.0045	169
16.0922.ZAM.4060	124	17.0321.PNR.1020	142	17.0691.VNR.2123	138	18.1429.ZNM.0300	162
16.0922.ZAM.4100	124	17.0321.VND.0016	143	17.0691.VNR.2555	138	18.1430.BBO.0035	169
16.0922.ZAM.4150	124	17.0321.VND.0036	143	17.0691.VNR.5123	139	18.1434.BBD.0035	169
16.0922.ZUM.3060	124	17.0321.VNK.0016	143	17.0691.VNR.5155	139	18.1434.BBD.0055	169
16.0922.ZUO.0012	136	17.0321.VNK.0036	143	17.0691.VNR.5223	139	18.1434.BBO.0035	169
16.0922.ZUO.0014	136	17.0321.VNL.1020	142	17.0691.VNR.5255	139	18.1434.BBO.0055	169
16.0922.ZZC.3060	124	17.0321.VNR.0016	143	17.0750.ZNO.0585	146	18.1434.BMM.0035	169
16.0922.ZZC.3100	124	17.0321.VNR.0036	143	17.0797.VNU.0516	152	18.1434.BMM.0045	169
16.0922.ZZC.7080	126	17.0321.VNR.1020	142	17.0797.VNU.0517	152	18.1434.BMM.0055	169
16.0923.VNR.0511	127	17.0322.PND.0016	145	17.0869.VNU.0000	89	18.1434.BMO.0045	169
16.0923.ZUO.1004	127	17.0322.PND.0036	145	17.0869.VNU.0123	147	18.1434.BNM.0055	169
16.0926.VNC.0037	123	17.0322.PNK.0016	145	17.0869.VNU.0555	147	18.1436.BMO.0038	170
16.0926.VNR.0029	123	17.0322.PNK.0036	145	17.0869.ZUO.0101	147	18.1436.BNM.0038	170
16.0926.VNR.0040	123	17.0322.PNL.1020	143	17.1085.ZNO.0001	139	18.1462.BNM.0038	170
16.0926.VNR.0053	123	17.0322.PNR.0016	145	18.0003.BMO.0038	166	18.1484.BBO.0040	170
16.0926.VNR.0526	123	17.0322.PNR.0036	145	18.0003.BNO.0038	166	18.1484.BMM.0050	170
16.0926.ZUO.8392	124	17.0322.PNR.1020	143	18.0008.BMO.0040	166	18.1484.BMO.0040	170
16.0927.VNU.0000	126	17.0322.VND.0016	145	18.0008.BNM.0040	166	18.1484.BSO.0040	170
16.0940.ZKO.0071	134	17.0322.VND.0036	145	18.0009.BBO.0040	166	18.1485.BNM.0040	171
16.0940.ZSL.1004	134	17.0322.VNK.0016	145	18.0009.BNO.0040	166	18.1601.BMO.0035	171
16.0940.ZSR.1003	134	17.0322.VNK.0036	145	18.0012.BBO.0036	167	18.1604.BNM.0035	171
16.0940.ZWO.0007	133	17.0322.VNL.1020	143	18.0012.BMO.0036	167	18.1604.BNM.0045	171
16.0952.VNE.0031	129	17.0322.VNR.0016	145	18.0013.BBO.0040	167	18.1622.BNM.0040	172
16.0952.VNE.0036	129	17.0322.VNR.0036	145	18.0016.BBO.0031	171	18.1624.BNO.0040	172
16.0952.VNE.0039	129	17.0322.VNR.1020	143	18.0018.BBO.0037	174	18.1638.BBD.0030	172
16.0952.VNE.0042	129	17.0322.ZNO.7321	145	18.0018.BMO.0037	174	18.1646.BMO.0035	172
16.0952.VNR.0040	129	17.0322.ZNO.7322	146	18.0021.BNM.0040	174	18.1651.BMO.0035	173
16.0952.ZSO.1504	130	17.0326.PNR.2005	152	18.0021.BNO.0040	174	18.1651.BMO.0038	173
16.0952.ZUL.0488	133	17.0326.VNR.0001	152	18.0025.BNM.0040	174	18.1651.BNO.0035	173
16.0952.ZUO.0485	129	17.0503.ZWO.000	146	18.1089.ZKB.0001	157	18.1651.BNO.0038	173
16.0952.ZUO.0486	132	17.0622.SNO.0014	153	18.1089.ZKW.0002	157	18.1652.BMO.0035	173
16.0952.ZUO.1403	130	17.0622.SNO.0015	153	18.1090.ZNO.0001	158	18.1652.BMO.0036	173
16.0952.ZUR.0488	133	17.0622.SNO.0018	153	18.1093.ZKB.0002	158	18.1652.BNM.0035	173
16.0952.ZUS.0485	130	17.0622.SNO.4123	153	18.1093.ZKW.0001	158	18.1652.BNM.0036	173
16.1218.ZZO.0001	134	17.0622.ZCO.2003	153	18.1103.ZMO.0001	158	18.1652.BNO.0035	173
16.1219.ZZO.0002	134	17.0625.SNO.6123	153	18.1103.ZNO.0008	158	18.1652.BNO.0036	173
16.1266.ZWO.0001	135	17.0676.VNU.6317	149	18.1108.ZBO.0005	158	18.1666.BNM.0035	173
17.0282.PNR.4215	152	17.0676.VNU.6340	149	18.1108.ZMO.0001	158	18.1800.ZNO.0400	157
17.0311.PNR.0020	148	17.0677.VNL.0123	149	18.1109.ZNO.0001	159	18.1807.ZNO.0100	160
17.0320.PND.0016	140	17.0677.VNL.0555	149	18.1117.ZBO.0003	159	18.2175.ZMO.0300	162
17.0320.PND.0036	140	17.0677.VNR.0123	149	18.1117.ZMO.0002	159	18.2175.ZNM.0300	162
17.0320.PNK.0016	140	17.0677.VNR.0555	149	18.1117.ZNO.0001	159	18.2575.ZBO.0300	162
17.0320.PNK.0036	140	17.0677.ZCO.6303	149	18.1244.ZNO.0002	156	18.2575.ZMO.0300	162
17.0320.PNL.1020	139	17.0680.VNU.0123	150	18.1278.ZNO.0011	156	18.2575.ZNM.0300	162
17.0320.PNR.0016	140	17.0680.VNU.0555	150	18.1290.ZNO.0001	156	18.2575.ZNO.0300	162
17.0320.PNR.0036	140	17.0681.VCU.0123	150	18.1291.ZNK.0101	157	18.2619.ZKO.0003	175
17.0320.PNR.1020	139	17.0681.VCU.0555	150	18.1291.ZNO.0001	157	18.3011.ZNO.0100	160
17.0320.VND.0016	140	17.0681.ZCO.6303	150	18.1329.ZNM.0300	161	18.4005.ZNO.0010	160

Artikel-Nr. Verzeichnis

Ein Verzeichnis der **ehemaligen** Artikelnummern finden Sie auf Seite 12

Artikel-Nr.	Seite
18.4516.ZNO.0110	161
18.6516.ZNO.0019	175
18.7510.ZNO.0200	161
18.8238.ZZO.0033	56
18.8238.ZZO.0041	99
18.9210.ZBO.0052	163
18.9210.ZMO.0050	163
18.9210.ZNM.0051	163
18.9227.ZMM.0003	163
18.9227.ZMO.0002	163
18.9227.ZNM.0001	163
18.9230.ZMO.0013	163
18.9240.ZNM.0011	164
18.9264.ZMM.0002	164
18.9264.ZMN.0001	164
18.9265.ZBO.0023	164
18.9267.ZNM.0001	164
18.9268.ZBD.0014	165
18.9268.ZBO.0039	165
18.9268.ZMM.0017	165
18.9268.ZNM.0005	165
18.9272.ZNM.0001	165
18.9932.ZBO.0002	165

Verzeichnis der ehemaligen Artikelnummern

Ein Verzeichnis der **aktuellen** Artikelnummern finden Sie auf Seite 8

Artikel-Nr.	Seite	Artikel-Nr.	Seite	Artikel-Nr.	Seite	Artikel-Nr.	Seite
(0060.501.123)	19	(0425.501.001.0020)	64	(0792.501.001)	80	(0906.003.033)	135
(0060.501.555)	19	(0425.502.001.0020)	64	(0792.601.001)	80	(0912.003.001)	135
(0060.501.999)	19	(0425.507.001.0020)	64	(0793.501.001)	83	(0912.003.002)	135
(0065.501.123)	19	(0426.001.000.0015)	70	(0793.502.001)	83	(0912.003.003)	135
(0065.501.555)	19	(0426.002.000.0015)	70	(0793.503.001)	83	(0912.003.004)	135
(0065.501.999)	19	(0426.005.000.0025)	70	(0796.551.001)	84	(0912.003.005)	135
(0077.504.000)	23	(0426.006.000.0025)	70	(0797.516.001)	152	(0912.003.007)	135
(0133.051.000.0015)	98	(0426.009.000.0030)	70	(0797.517.001)	152	(0916.620.802.0600)	127
(0133.080.000)	98	(0426.010.000.0030)	70	(0797.531.001)	85	(0916.620.802.1000)	127
(0170.212.000)	99	(0426.013.000.0015)	70	(0797.531.001)	109	(0922.101.002)	136
(0170.511.001)	99	(0426.014.000.0015)	70	(0827.002.001)	91	(0922.101.003)	136
(0171.501.001)	101	(0426.017.000.0020)	70	(0827.002.003)	91	(0922.250.803.0600)	124
(0192.501.001)	68	(0426.018.000.0020)	70	(0827.002.005)	91	(0922.450.804.0600)	124
(0204.501.001)	58	(0426.022.000.0030)	70	(0827.002.007)	92	(0922.450.804.1000)	124
(0204.511.001)	58	(0426.023.000.0030)	70	(0827.002.016)	92	(0922.450.804.1500)	124
(0205.501.001)	58	(0429.005.000.0012)	69	(0827.002.017)	92	(0922.501.001)	123
(0207.501.001)	59	(0429.006.000.0012)	69	(0827.002.021)	92	(0922.506.001)	123
(0207.551.001)	59	(0489.501.001)	68	(0827.002.022)	93	(0922.514.001)	123
(0210.551.001)	37	(0489.540.001)	68	(0827.002.052)	93	(0922.515.001)	123
(0213.501.001)	37	(0500.010.000)	24	(0827.002.074)	93	(0922.529.001)	123
(0213.502.001)	37	(0568.401.001)	36	(0827.002.075)	93	(0922.650.803.0600)	124
(0235.101.000.0015)	45	(0568.601.001)	35	(0827.002.091)	94	(0922.650.803.1000)	124
(0236.601.000.0015)	43	(0571.401.001)	36	(0827.601.001)	89	(0922.670.001.0800)	126
(0236.602.000.0020)	43	(0571.601.001)	36	(0829.002.001)	90	(0923.100.004)	127
(0236.603.000.0025)	43	(0622.001.014)	153	(0829.003.001)	90	(0923.511.001)	127
(0236.604.000.0030)	43	(0622.001.015)	153	(0829.003.001)	147	(0926.517.001)	123
(0236.605.000.0015)	43	(0622.001.018)	153	(0829.004.001)	90	(0926.519.001)	123
(0236.611.000.0015)	43	(0622.001.400)	153	(0829.101.123)	89	(0926.522.001)	123
(0236.612.000.0020)	43	(0624.002.003)	153	(0829.101.555)	89	(0926.526.001)	123
(0236.613.000.0025)	43	(0625.006.123)	153	(0839.102.000)	124	(0927.501.001)	126
(0236.614.000.0030)	43	(0676.502.001)	149	(0849.501.001)	109	(0940.007.000)	133
(0236.615.000.0015)	43	(0676.552.001)	149	(0849.502.001)	109	(0940.071.001)	134
(0238.300.001)	55	(0677.501.123)	149	(0849.504.001)	109	(0940.100.003)	134
(0238.400.001)	55	(0677.501.555)	149	(0849.532.001)	109	(0940.100.004)	134
(0247.501.001.0015)	31	(0677.502.123)	149	(0863.003.000)	61	(0952.501.001)	129
(0247.502.001.0020)	31	(0677.502.555)	149	(0868.102.001)	90	(0952.503.001)	129
(0247.503.001.0015)	31	(0680.501.123)	150	(0868.534.123)	89	(0952.509.001)	129
(0247.551.001.0025)	31	(0680.501.555)	150	(0869.002.001)	97	(0952.515.001)	129
(0247.552.001.0030)	31	(0681.500.123)	150	(0869.002.006)	97	(1070.001.000)	101
(0248.501.001.0015)	32	(0681.500.555)	150	(0869.002.017)	97	(1085.001.000)	139
(0248.502.001.0020)	32	(0687.501.000)	150	(0869.002.017)	147	(1089.001.000)	157
(0248.503.001.0015)	32	(0689.503.123)	138	(0869.002.020)	97	(1089.002.000)	157
(0248.551.001.0025)	32	(0689.503.555)	138	(0869.002.020)	148	(1090.001.000)	158
(0248.552.001.0030)	32	(0689.511.123)	138	(0869.002.025)	98	(1093.001.000)	158
(0358.601.001)	102	(0689.511.555)	138	(0869.002.025)	148	(1093.002.000)	158
(0358.602.001)	102	(0690.501.123)	138	(0869.002.028)	98	(1103.001.000)	158
(0359.501.001)	102	(0690.501.555)	138	(0869.002.028)	148	(1103.008.000)	158
(0359.502.001)	102	(0690.502.123)	138	(0869.101.001)	147	(1108.001.000)	158
(0393.500.001)	79	(0690.502.555)	138	(0869.544.000)	89	(1108.005.000)	158
(0393.504.001)	79	(0691.501.123)	138	(0869.544.123)	147	(1109.001.000)	159
(0393.522.001)	79	(0691.501.555)	138	(0869.544.555)	147	(1117.001.000)	159
(0393.523.001)	79	(0691.502.123)	138	(0873.100.000)	111	(1117.002.000)	159
(0393.525.001)	79	(0691.502.555)	138	(0873.101.001)	111	(1117.003.000)	159
(0394.501.001)	79	(0691.503.123)	138	(0873.514.001)	111	(1146.001.000)	102
(0394.502.001)	79	(0691.503.555)	138	(0873.520.001)	111	(1146.003.000)	102
(0405.017.000.0020)	69	(0691.504.123)	138	(0873.551.001)	111	(1147.001.000)	102
(0405.018.000.0030)	69	(0691.504.555)	138	(0875.501.001)	111	(1149.001.000)	103
(0405.022.000.0025)	69	(0691.551.123)	139	(0880.501.001)	113	(1176.003.000)	62
(0405.023.000.0035)	69	(0691.551.555)	139	(0906.003.017)	135	(1176.003.000)	159
(0405.024.000.0040)	69	(0691.552.123)	139	(0906.003.020)	135	(1180.001.000)	101
(0405.045.000.0015)	69	(0691.552.555)	139	(0906.003.021)	135	(1180.101.000)	101
(0425.201.000.0009)	64	(0724.002.002)	55	(0906.003.023)	135	(1181.001.000)	99
(0425.202.000.0009)	64	(0724.002.053)	55	(0906.003.024)	135	(1182.001.000)	68

Verzeichnis der ehemaligen Artikelnummern

Ein Verzeichnis der **aktuellen** Artikelnummern finden Sie auf Seite 8

Artikel-Nr.	Seite	Artikel-Nr.	Seite	Artikel-Nr.	Seite	Artikel-Nr.	Seite
(1211.001.000)	61	(1434.002.000)	169	(9240.011.000)	164	(143021215)	113
(1218.001.000)	134	(1434.004.000)	169	(9264.001.000)	164	(143022215)	113
(1219.002.000)	134	(1434.012.000)	169	(9264.002.000)	164	(143111215)	114
(1224.011.000)	51	(1434.020.000)	169	(9265.023.000)	164	(143112215)	114
(1224.014.000)	51	(1434.029.000)	169	(9267.001.000)	164	(143115215)	114
(1225.011.000)	52	(1434.030.000)	169	(9268.005.000)	165	(143121215)	114
(1225.020.000)	52	(1434.031.000)	169	(9268.014.000)	165	(143122215)	114
(1232.802.000.1000)	47	(1434.039.000)	169	(9268.017.000)	165	(143125215)	114
(1232.802.000.1200)	47	(1434.040.000)	169	(9268.039.000)	165	(143151215)	114
(1232.802.000.2000)	47	(1436.001.000)	170	(9272.001.000)	165	(143152215)	114
(1232.817.000.1000)	47	(1436.002.000)	170	(9932.002.000)	165	(143155215)	114
(1232.817.000.1200)	47	(1462.001.000)	170	(040014132)	178	(143161215)	114
(1232.817.000.2000)	47	(1484.005.000)	170	(040083060)	179	(143162215)	114
(1233.802.000.1200)	47	(1484.007.000)	170	(040083060)	180	(143165215)	114
(1233.802.000.2000)	47	(1484.009.000)	170	(040154130)	179	(143204165)	140
(1237.805.000.1000)	60	(1484.012.000)	170	(040154130)	180	(143204167)	140
(1237.805.000.1500)	60	(1485.020.000)	171	(124900151)	76	(143204168)	140
(1244.002.000)	156	(1550.001.019)	21	(124900152)	77	(143204365)	140
(1262.083.000)	49	(1550.018.000)	19	(124900201)	76	(143204367)	140
(1262.084.000)	49	(1550.018.999)	19	(124900202)	77	(143204368)	140
(1262.141.000)	49	(1550.101.000)	21	(124900251)	76	(143214165)	142
(1262.142.000)	49	(1551.001.001)	23	(124900252)	77	(143214167)	142
(1262.263.000)	49	(1555.027.000)	21	(124900301)	76	(143214168)	142
(1262.264.000)	49	(1555.103.000)	21	(124900302)	77	(143214365)	142
(1262.283.000)	49	(1577.001.000)	23	(124900351)	76	(143214367)	142
(1262.284.000)	49	(1587.001.000)	23	(124900352)	77	(143214368)	142
(1262.401.000)	49	(1588.001.000)	24	(124900401)	76	(143224165)	145
(1262.402.000)	49	(1590.018.000)	24	(124900402)	77	(143224167)	145
(1264.003.000)	50	(1601.016.000)	171	(132824215)	152	(143224168)	145
(1264.004.000)	50	(1604.024.000)	171	(133500181)	77	(143224365)	145
(1264.011.000)	50	(1622.007.000)	172	(133500182)	77	(143224367)	145
(1264.012.000)	50	(1624.030.000)	172	(133500183)	77	(143224368)	145
(1264.013.000)	50	(1638.004.000)	172	(135300121)	71	(143262005)	152
(1264.014.000)	50	(1646.049.000)	172	(135300122)	71	(143754025)	91
(1264.051.000)	50	(1651.007.000)	173	(135300151)	71	(143764025)	91
(1264.052.000)	50	(1651.010.000)	173	(135300152)	71	(143972005)	64
(1266.001.000)	135	(1652.010.000)	173	(135300201)	71	(143972006)	64
(1278.011.000)	156	(1652.025.000)	173	(135300202)	71	(143972007)	64
(1288.001.000)	83	(1652.039.000)	173	(135300251)	71	(144161155)	105
(1288.001.000)	156	(1666.053.000)	173	(135300252)	71	(144161156)	105
(1290.001.000)	156	(1844CCV Silber L.)	120	(135300301)	71	(144161225)	105
(1291.001.000)	157	(1844CCV Silber R.)	120	(135300302)	71	(144161226)	105
(1291.101.000)	157	(2618.003.001)	56	(137000001)	44	(144162155)	105
(1337.001.002)	53	(2619.003.001)	175	(137000002)	44	(144162156)	105
(1338.004.000)	53	(6303.022.001)	150	(137000151)	44	(144162225)	105
(1338.023.000)	54	(6303.022.050)	149	(137000152)	44	(144162226)	105
(1339.001.000)	54	(6516.019.001)	175	(137000201)	44	(144292095)	129
(1339.009.000)	54	(6516.019.015)	41	(137000202)	44	(144372005)	65
(1354.001.000)	159	(8238.033.000)	56	(137000251)	44	(144372006)	65
(1354.002.000)	159	(8238.041.000)	99	(137000252)	44	(144372007)	65
(1357.001.000)	54	(8871.001.001)	39	(137000301)	44	(144712035)	127
(1360.002.000)	160	(8871.100.001)	37	(137000302)	44	(145012005)	80
(1360.003.000)	160	(8902.001.001)	39	(137007008)	45	(145122005)	109
(1408.015.000)	167	(9018.071.000)	41	(137007158)	45	(145142005)	84
(1409.005.000)	167	(9080.001.000)	41	(137007208)	45	(145152005)	85
(1409.006.000)	167	(9081.001.000)	40	(137007258)	45	(145212005)	80
(1410.001.000)	168	(9210.050.000)	163	(137007308)	45	(145300121)	70
(1410.016.000)	168	(9210.051.000)	163	(142972005)	59	(145300122)	71
(1410.017.000)	168	(9210.052.000)	163	(142972006)	59	(145300151)	70
(1413.008.000)	168	(9227.001.000)	163	(142972007)	59	(145300152)	71
(1425.026.000)	168	(9227.002.000)	163	(142972007)	132	(145300201)	70
(1427.009.000)	169	(9227.003.000)	163	(143011215)	113	(145300202)	71
(1430.011.000)	169	(9230.013.000)	163	(143012215)	113	(145300251)	70

Verzeichnis der ehemaligen Artikelnummern

Ein Verzeichnis der *aktuellen* Artikelnummern finden Sie auf Seite 8

Artikel-Nr.	Seite	Artikel-Nr.	Seite	Artikel-Nr.	Seite	Artikel-Nr.	Seite
(145300252)	71	(443714600)	117	(584440000)	40	(1429767003)	132
(145300301)	70	(443714720)	95	(584721900)	39	(1431128001)	148
(145300302)	71	(443714770)	96	(584740000)	40	(1432021201)	139
(145807250)	73	(443714770)	117	(585107321)	73	(1432021202)	139
(145842255)	67	(444161000)	106	(588871001)	36	(1432060161)	140
(145842256)	67	(444165000)	106	(620300600)	166	(1432060163)	140
(146602405)	67	(444516110)	161	(620300600)	173	(1432060164)	140
(147000001)	44	(447510200)	161	(621200800)	167	(1432060361)	140
(147000002)	45	(448270027)	96	(640171000)	28	(1432060363)	140
(147000151)	44	(448270027)	118	(640171310)	27	(1432060364)	140
(147000152)	45	(448270044)	96	(640171330)	27	(1432061201)	140
(147000201)	44	(448270045)	96	(640300600)	166	(1432061202)	140
(147000202)	45	(448270046)	96	(640300600)	173	(1432121201)	142
(147000251)	44	(458012200)	77	(640900700)	166	(1432121202)	142
(147000252)	45	(461902000)	115	(642000650)	173	(1432160161)	143
(147000301)	44	(472575300)	162	(642100700)	174	(1432160163)	143
(147000302)	45	(481329300)	161	(645289959)	27	(1432160164)	143
(147007008)	46	(481429300)	162	(645289960)	27	(1432160361)	143
(147007158)	46	(482175300)	162	(649219988)	26	(1432160363)	143
(147007208)	46	(482575300)	162	(649289988)	26	(1432160364)	143
(147007258)	46	(500000500)	34	(649289989)	26	(1432161201)	142
(147007308)	46	(500000504)	118	(649299992)	28	(1432161202)	142
(160405015)	69	(507220000)	46	(650800750)	166	(1432221201)	143
(160405020)	69	(507500520)	54	(651800700)	174	(1432221202)	143
(160405025)	69	(510000503)	146	(670900700)	166	(1432260161)	145
(160405030)	69	(537104670)	47	(671200800)	167	(1432260163)	145
(160405035)	69	(537104680)	47	(671300700)	167	(1432260164)	145
(160405040)	69	(537194670)	48	(671600700)	171	(1432260361)	145
(164302005)	130	(537194680)	48	(671800700)	174	(1432260363)	145
(184410005)	34	(537400652)	51	(672000650)	173	(1432260364)	145
(184410006)	34	(537401613)	48	(680800750)	166	(1432261201)	143
(184710005)	34	(537401623)	48	(681410700)	168	(1432261202)	143
(184710006)	34	(537490710)	51	(681410800)	168	(1432660001)	152
(241823027)	26	(537491611)	48	(681604750)	171	(1441660151)	105
(241823028)	26	(537491621)	48	(682000650)	173	(1441660152)	105
(241823029)	26	(537500570)	53	(682100700)	174	(1441660221)	105
(241823030)	26	(540600430)	60	(682500700)	174	(1441660222)	105
(241823036)	26	(540600431)	60	(0952014003)	130	(1441661151)	106
(401904000)	114	(540800430)	60	(0952015004)	130	(1441661152)	106
(404246840)	126	(540800430)	133	(1147530170)	118	(1441661221)	106
(404246850)	126	(541000431)	60	(1147530180)	118	(1441661222)	106
(422175300)	162	(542920410)	60	(1153908106)	119	(1451567001)	85
(422575300)	162	(543200120)	146	(1153908206)	119	(1455722150)	65
(440060010)	160	(547104670)	47	(1153908600)	119	(1455722200)	65
(441800400)	157	(547104680)	47	(1153908601)	119	(1455722250)	65
(441807100)	160	(547194670)	48	(1157529120)	119	(1455722300)	65
(442200400)	81	(547194680)	48	(1157529120)	119	(1455763150)	65
(442200400)	157	(547400652)	51	(1157529120)	119	(1455763200)	65
(442211430)	62	(547401613)	48	(1157532470)	119	(1455763250)	65
(442575300)	162	(547401623)	48	(1157532480)	119	(1455763300)	65
(442920370)	61	(547490710)	51	(1157622650)	119	(1458467251)	67
(443011100)	160	(547491611)	48	(1157622650)	119	(1458467252)	67
(443014101)	84	(547491621)	48	(1157622650)	119	(1466067400)	67
(443014101)	161	(547500510)	52	(1168098731)	120	(1475722000)	31
(443130280)	115	(547500540)	52	(1168099731)	120	(1475722150)	31
(443247321)	145	(547500550)	52	(1168730098)	120	(1475722200)	31
(443247322)	146	(547500570)	53	(1168730099)	120	(1475722250)	31
(443710230)	94	(547500580)	53	(1420422001)	58	(1475722300)	31
(443711610)	94	(547500585)	146	(1420422002)	58	(1475763000)	31
(443711660)	94	(562920411)	133	(1420463002)	58	(1475763150)	31
(443713290)	95	(567104640)	50	(1429767001)	59	(1475763200)	31
(443714150)	95	(577407110)	46	(1429767002)	59	(1475763250)	31
(443714600)	95	(584421900)	39	(1429767003)	59	(1475763300)	31

Verzeichnis der **ehemaligen** Artikelnummern

Ein Verzeichnis der **aktuellen** Artikelnummern finden Sie auf Seite 8

Artikel-Nr.	Seite
(1492660001)	123
(1495263031)	129
(1643067001)	132
(1844000032)	120
(1844000042)	120
(1844152004)	120
(1844152005)	120
(1856860001)	35
(1856860002)	35
(1857160001)	35
(1857160002)	35
(4383118201)	129
(4383118211)	130
(4383118251)	132
(4383118251)	133
(4383118861)	133
(4383118862)	133
(64500210000)	27
(64500220000)	27
(640571000001)	118
(640571000034)	118
(3657124001001)	116
(3657124001034)	116
(3657124002001)	117
(3657124002034)	117
(3657134001001)	116
(3657134001034)	116
(3657134002001)	117
(3657134002034)	117



Zylinder und Schlüssel

Inhalt

Wechselzylinder VCS18

Wechselzylinder TriKey

Wechselzylinder Z23

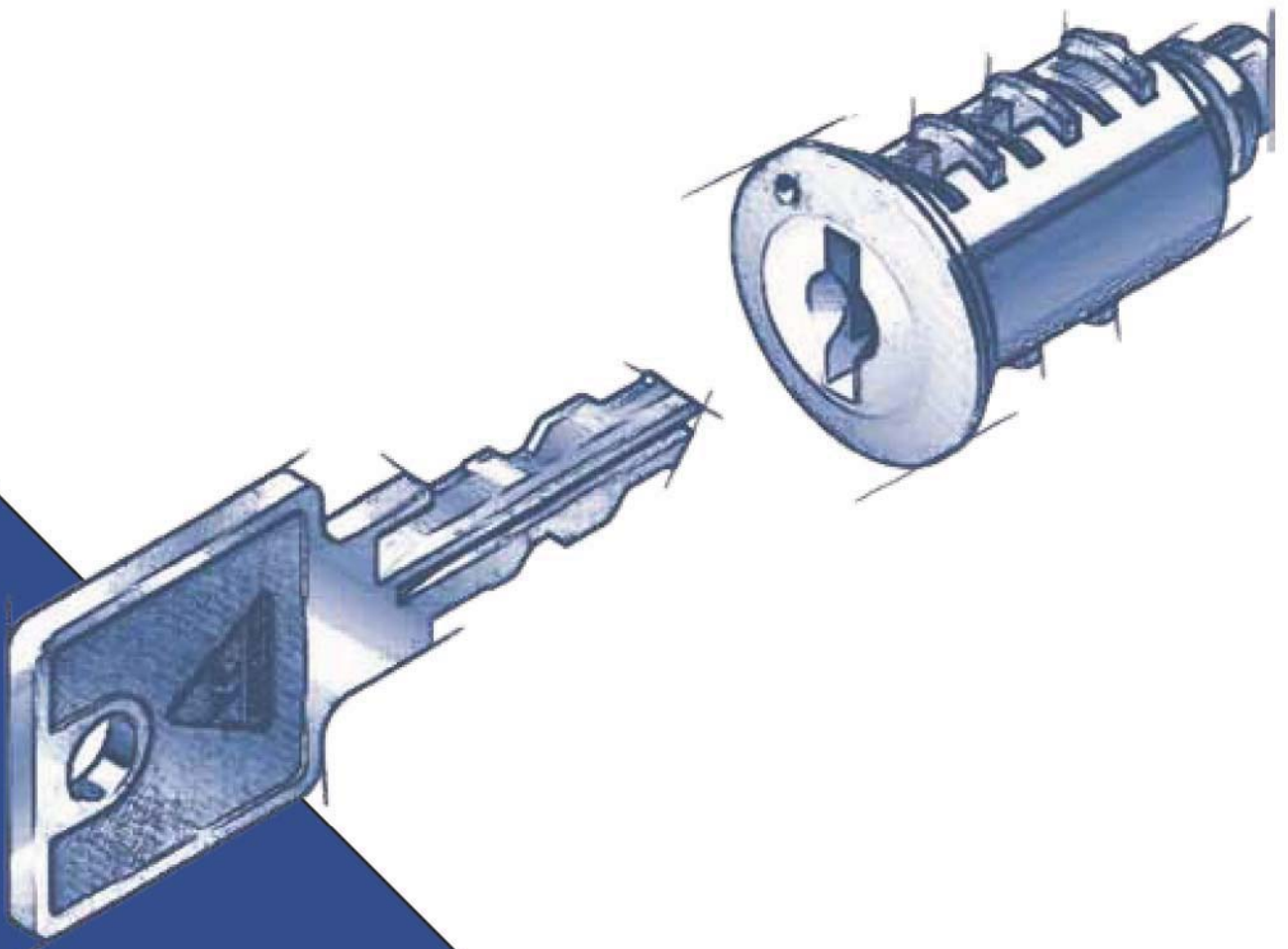



Der HUWIL Wechselzylinder VCS18

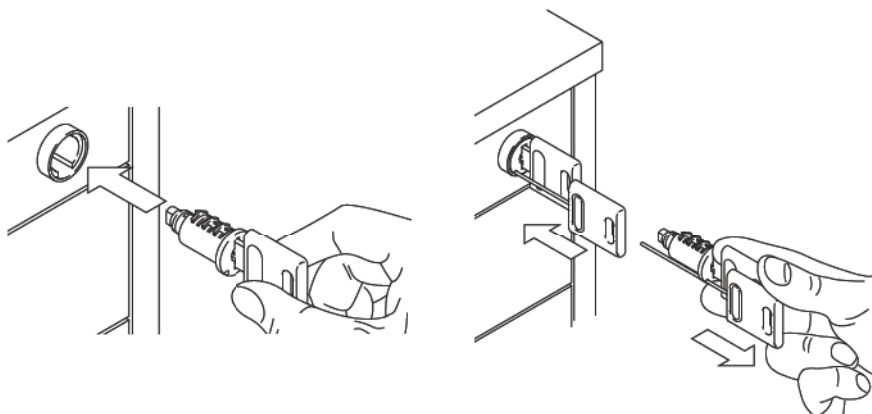
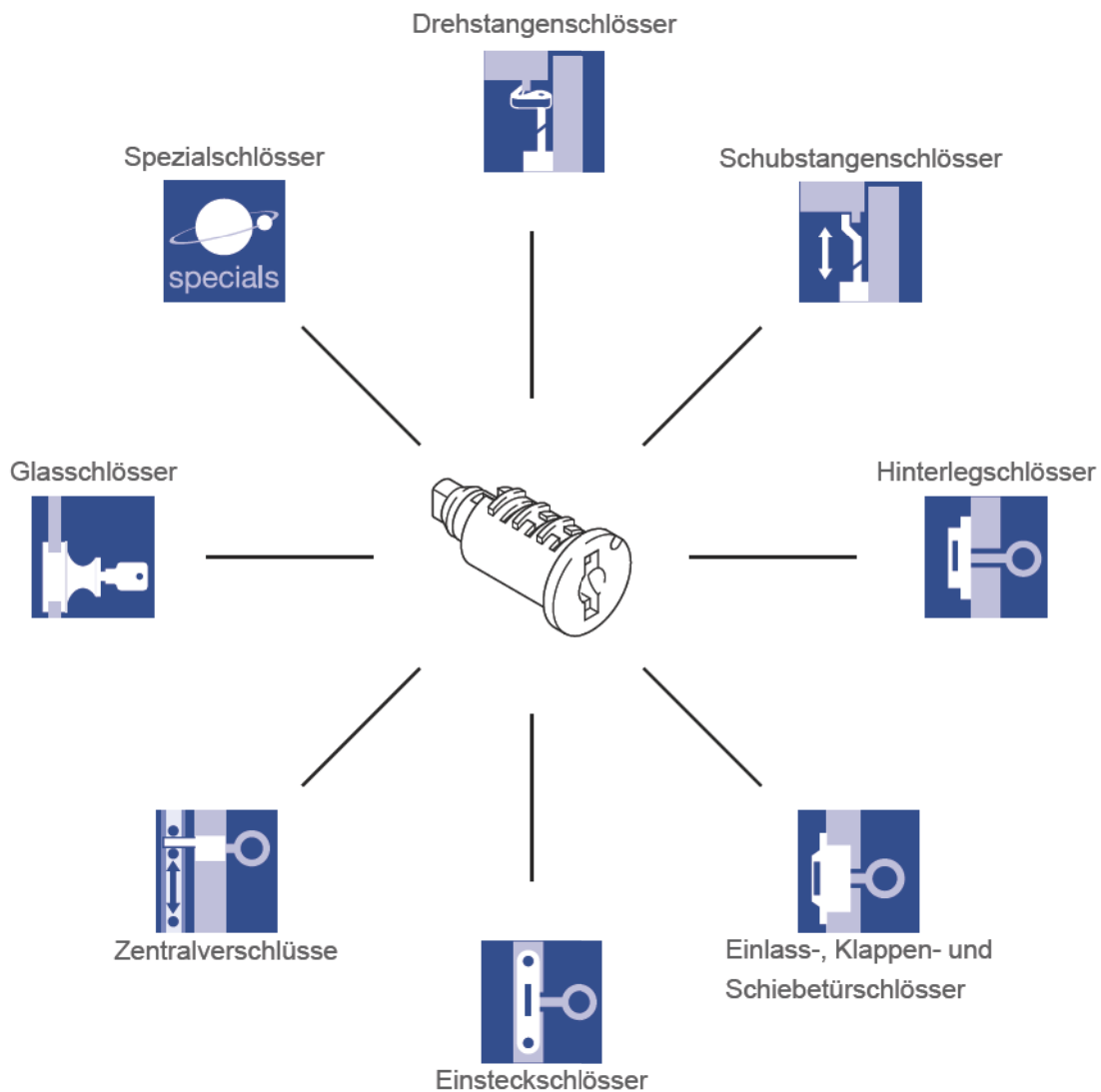



Wechselzylinder VCS18 Typ 0060

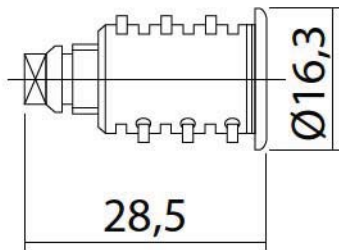

inkl. 2 Schlüssel
Metallguss
matt vernickelt
VPE 50



Artikelnummer	ehemals	Schließung
11.0060.VNS.0123	(0060.501.123)	verschiedenschließend
11.0060.VNS.3131	(0060.501.555)	gleichschließend
11.0060.VNS.0999	(0060.501.999)	mit HS-Funktion

Wechselzylinder VCS18 bombiert Typ 0065

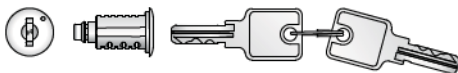

inkl. 2 Schlüssel
Metallguss
matt vernickelt
VPE 50



Artikelnummer	ehemals	Schließung
11.0065.VNS.0123	(0065.501.123)	verschiedenschließend
11.0065.VNS.3131	(0065.501.555)	gleichschließend
11.0065.VNS.0999	(0065.501.999)	mit HS-Funktion

Ersatz-Zylinderschlüssel Typ 1550

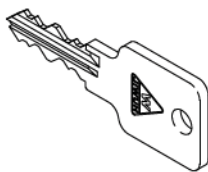

für Zylinder VCS18
(nur paarweise lieferbar)
Stahl
vernickelt
VPE 10



Artikelnummer	ehemals	Schließung
11.1550.VNZ.0018	(1550.018.000)	Schließkreise 3000 und 5000
11.1550.VNZ.0999	(1550.018.999)	HS-Anlagen (nur mit Sicherungsschein)



Der HUWIL Wechselzylinder VCS 18

Hauptschließanlage mit Sicherungsschein

Hauptschlüssel



9001AA - 9999ZZ



Schließungsschlüssel

Wendeschlüssel mit Flachbahnprofil



9001AA - 9999ZZ



Schließungsschlüssel

Wendekippschlüssel mit Flachbahnprofil



9001AA - 9999ZZ



Schlüssel und Zylinder sind numeriert



Zylinderschlüssel Typ 1550 mit Huwil-Kappe

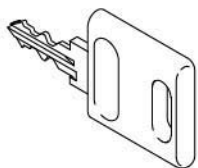

für Zylinder VCS18
Stahl vernickelt
Kunststoff schwarz
VPE 10



Artikelnummer	ehemals
11.1550.VNZ.0019	(1550.001.019)

Zylinderschlüssel Typ 1550 mit Huwil-Kappe, klappbar

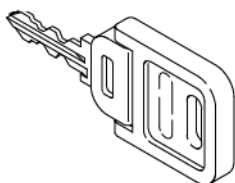

für Zylinder VCS18
Stahl vernickelt
Kunststoff schwarz
VPE 10



Artikelnummer	ehemals
11.1550.VNC.0101	(1550.101.000)

Flachbahnschlüssel Typ 1555



für Zylinder VCS18
(nur paarweise lieferbar)
Messing
vernickelt
VPE 10



Artikelnummer	ehemals
11.1555.VNF.0027	(1555.027.000)

Zylinderflachbahnschlüssel Typ 1555 mit Kappe neutral eckig, klappbar



für Zylinder VCS18
Stahl Kunststoff
vernickelt schwarz
VPE 10



Artikelnummer	ehemals
11.1555.VNC.0103	(1555.103.000)



Der HUWIL Wechselzylinder VCS18 TriKey Gruppenhauptschließanlage mit Zertifikat

Gruppenhauptschlüssel



Gruppenschlüssel

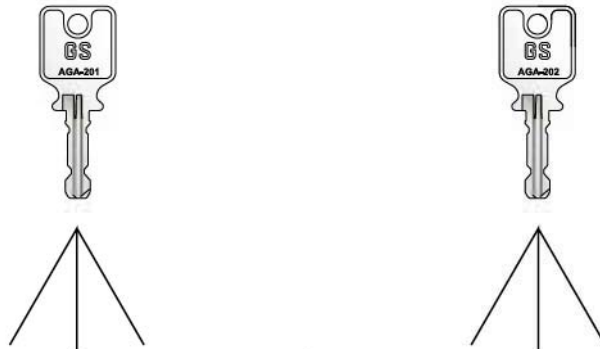

Schließungs-
schlüssel

Wendeschlüssel

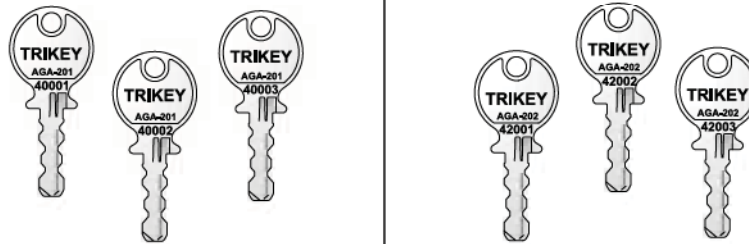

Schließplan

Übersicht Anlage **AGA**

(ebenfalls erhältlich Anlage AGB / AGC / AGD / AGE)

Gruppen	AGA																			
Anlage AGA	AGA-201	AGA-202	AGA-203	AGA-204	AGA-205	AGA-206	AGA-207	AGA-208	AGA-209	AGA-210	AGA-211	AGA-212	AGA-213	AGA-214	AGA-215	AGA-216	AGA-217	AGA-218	AGA-219	AGA-220
je Gruppe 1900 Einzelschließungen	41900	43900	45900	47900	49900	51900	53900	55900	57900	59900	61900	63900	65900	67900	69900	71900	73900	75900	77900	79900
	40001	42001	44001	46001	48001	50001	52001	54001	56001	58001	60001	62001	64001	66001	68001	70001	72001	74001	76001	78001



Hauptschlüssel Typ 1551



für Zylinder VCS18
Stahl
vernickelt
VPE 1



Artikelnummer ehemals

11.1551.VNH.0001 (1551.001.001) für HS-fähige Wechselzylinder VCS18

Wechselzylinder VCS18 TriKey Typ 0077

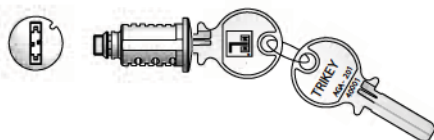

inkl. 2 Schlüssel
Metallguss / Messing
vernickelt
VPE 50



Artikelnummer ehemals

11.0077.VNG.0504 (0077.504.000)

Zylinderschlüssel Typ 1577 für VCS18 TriKey



Messing
vernickelt
VPE 10



Artikelnummer ehemals

11.1577.VNZ.0001 (1577.001.000)

Gruppenschlüssel Typ 1587 für VCS18 TriKey



Messing
vernickelt
VPE 10



Artikelnummer ehemals

11.1587.VNH.0001 (1587.001.000)



Zylinder und Schlüssel

Generalschlüssel Typ 1588 für VCS18 TriKey



Messing
vernickelt
VPE 1



Artikelnummer	ehemals
11.1588.VNG.0001	(1588.001.000)

Auslösenadel Typ 0500



für Wechselzylinder VCS18
Stahl
VPE 50

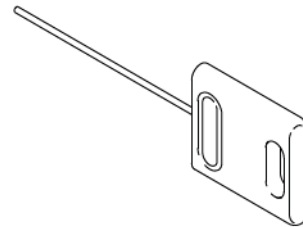

Artikelnummer	ehemals
11.0500.VNO.0010	(0500.010.000)

Ersatz-Zylinderschlüssel Typ 1590



für Zylinder 16,5 mm Durchmesser
(nur paarweise lieferbar)
Stahl
vernickelt
VPE 10

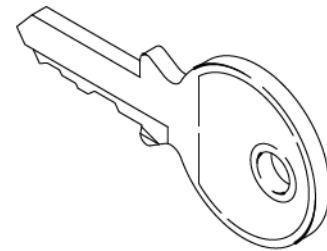

Artikelnummer	ehemals
11.1590.FNZ.0018	(1590.018.000)



Der LEHMANN Wechselzylinder Z23

Zylinder + Schlüssel

Schließkreis:

18001 - 19000

A 18001 - 18500

B 18501 - 19000



Gruppenhauptschlüssel

Betätigt die Schließungen der Gruppen HSA und HSB

GHS 12



18001 - 19000

HSA 12



18001 - 18500

HSB 12



18501 - 19000

Hauptschlüssel

Betätigt die Schließungen der Gruppen HSA oder HSB

Standard B1



18001 - 18500

Standard B1



18501 - 19000

Schließungsschlüssel

Wendeschlüssel

Flachbahn B5



18001 - 18500

Flachbahn B5



18501 - 19000

Schließungsschlüssel

Wendeschlüssel mit Flachbahnprofil

MAB 00



18001 - 19000

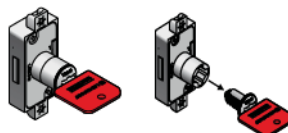

Demontageschlüssel

Demontagefunktion bei geöffnetem Schloss

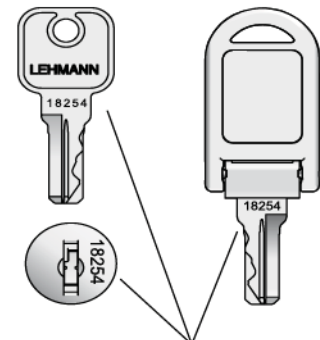

Schlüssel und Zylinder sind numeriert



Zylinder und Schlüssel

Zylinder Typ Z23 Durchmesser 18mm



mit Schlüsselsatz B1
vernickelt
VPE 25

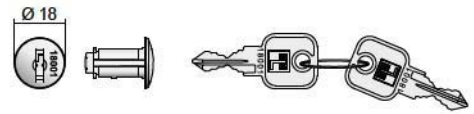

Artikelnummer	ehemals	Schließung
11.1823.PNZ.0123	(241823029)	SK 18001-18500
11.1823.PNZ.5123	(241823030)	SK 18501-19000
11.1823.PNZ.1111	(241823036)	SK 18001-18020

Zylinder Typ Z23 Durchmesser 18mm



mit Flachbahnschlüsselsatz B5
vernickelt
VPE 25



Artikelnummer	ehemals	Schließung
11.1823.PNF.0123	(241823027)	SK 18001-18500
11.1823.PNF.5123	(241823028)	SK 18501-19000

Ersatzschlüssel - Standardschlüssel B1



je 1 St. im Beutel nach Schließplan
vernickelt
VPE 1



Artikelnummer	ehemals	Schließung
11.9289.PNZ.0123	(649289988)	SK 18001-18500
11.9289.PNZ.5123	(649289989)	SK 18501-19000
11.9219.PNZ.4000	(649219988)	SK 4000 / 7000



Ersatzschlüssel - Flachbahnschlüssel B5



je 1 St. im Beutel nach Schließplan
vernickelt
VPE 1



Artikelnummer	ehemals	Schließung
11.5289.PNF.0123	(645289960)	SK 18001-18500
11.5289.PNF.5123	(645289959)	SK 18501-19000

Ersatzschlüssel - Flachbahnkippschlüssel C5



je 1 St. im Beutel nach Schließplan
vernickelt
VPE 1



Artikelnummer	ehemals	Schließung
11.5002.PNC.0123	(64500210000)	SK 18001-18500
11.5002.PNC.5123	(64500220000)	SK 18501-19000

Hauptschlüssel HSA 12 und HSB 12



für Zylinder Z23
Messing blank
VPE 1



Artikelnummer	ehemals	Schließung
11.0171.PNH.1800	(640171310)	SK 18001-18500 HSA 12
11.0171.PNH.1850	(640171330)	SK 18501-19000 HSB 12



Zylinder und Schlüssel

Generalhauptschlüssel GS 12



für Zylinder Z23
Messing blank
VPE 1



Artikelnummer	ehemals	Schließung
11.0171.PNG.1800	(640171000)	SK 18001-19000

Demontageschlüssel



für Zylinder Z23
Messing blank
VPE 10



Artikelnummer	ehemals	Schließung
11.9299.PNA.1800	(649299992)	SK 18001-19000



Stangenschlösser

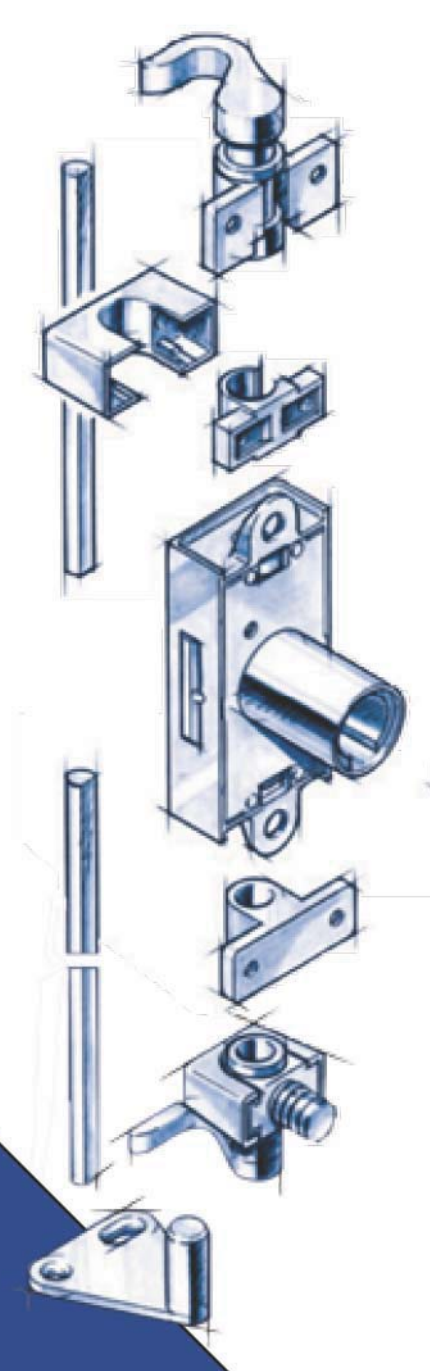

Inhalt

- Drehstangenschlösser für Zylinder
- Drehstangenschlösser für Drehknöpfe
- Drehknöpfe für Zylinder
- Drehknöpfe ohne Zylinder
- Drehstangenschlösser für Bartschlüssel
- Drehstangen und Zubehör

Inhalt

- Schubstangenschlösser
- Schubstangen und Zubehör

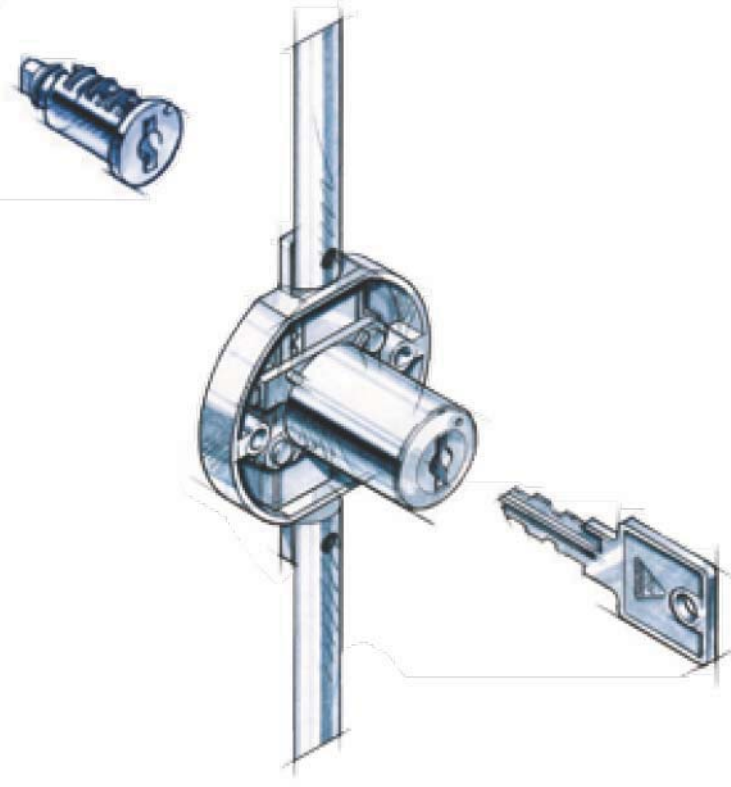

Typ 750/759

Einstellen 550 /750 rechts / links

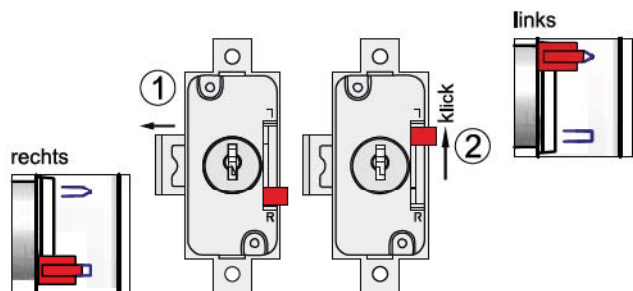

Einstellen Schlüsselabzugssperre 550 / 750

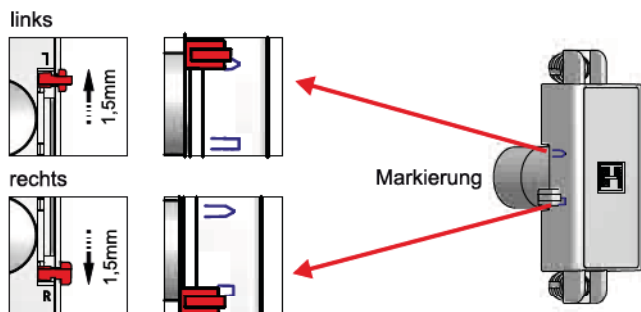

Stangenlängenberechnung

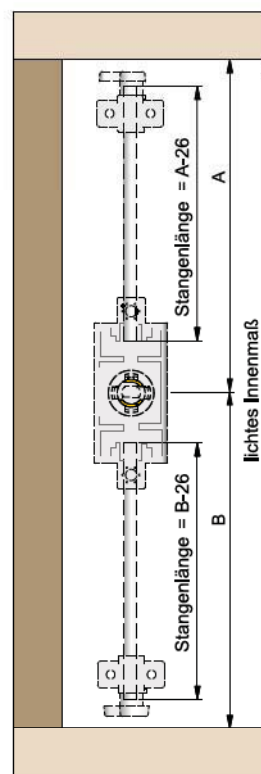

Drehstangenschloss
- schraubbar

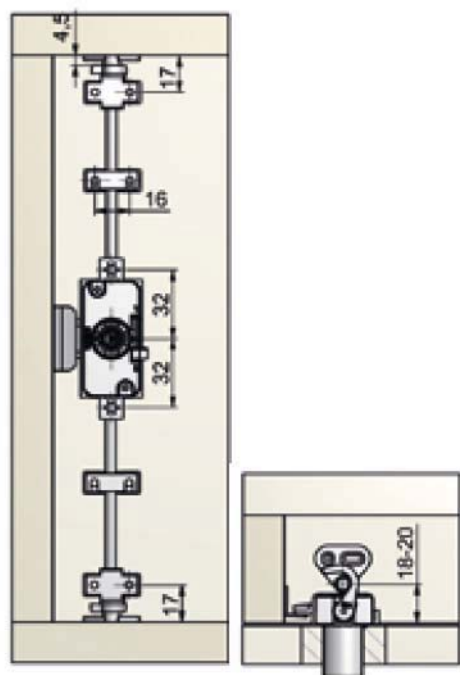

Drehstangenschloss
- dübelbar

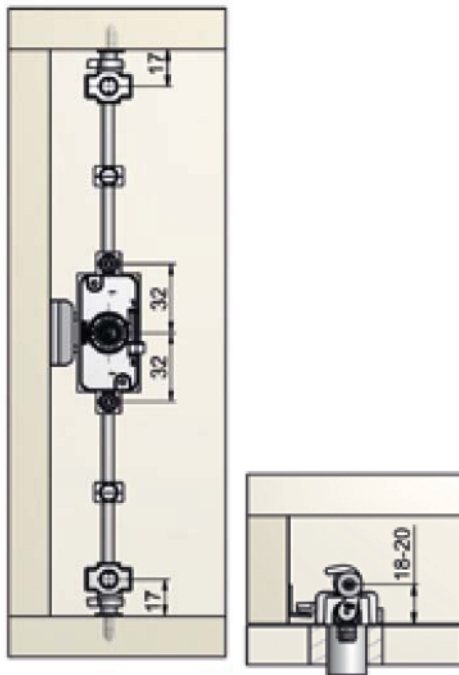

Bohrbild dübelbares
Drehstangenschloss

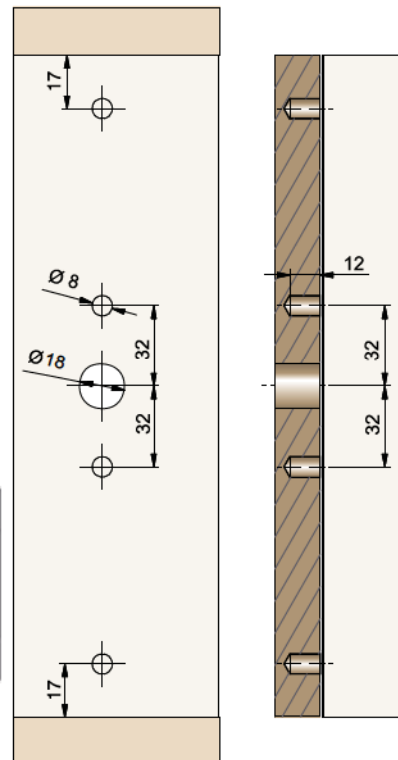



Drehstangenschloss Typ 750 P2

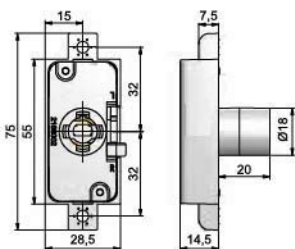

für Zylinder Z23
Durchmesser 18 mm
zum Aufschrauben
vernickelt
VPE 50



Artikelnummer	ehemals	Schließrichtung	Dornmaß
12.0750.PNU.0000	(1475722000)	R/L	00 mm ohne Mittelschluss
12.0750.PNU.0015	(1475722150)	R/L	15 mm
12.0750.PNU.0020	(1475722200)	R/L	20 mm
12.0750.PNU.0025	(1475722250)	R/L	25 mm
12.0750.PNU.0030	(1475722300)	R/L	30 mm

Drehstangenschloss Typ 750 VCS18.2

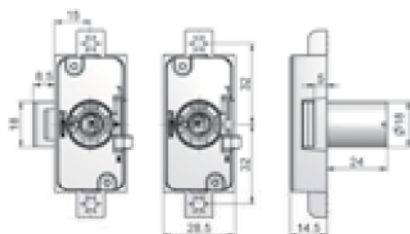

für Wechselzylinder VCS18
zum Aufschrauben
vernickelt
VPE 50



Artikelnummer	ehemals	Schließrichtung	Dornmaß
12.0750.VNU.0000	(1475763000)	R/L	00 mm ohne Mittelschluss
12.0750.VNU.0015	(1475763150)	R/L	15 mm
12.0750.VNU.0020	(1475763200)	R/L	20 mm
12.0750.VNU.0025	(1475763250)	R/L	25 mm
12.0750.VNU.0030	(1475763300)	R/L	30 mm

Drehstangenschloss Typ 0247

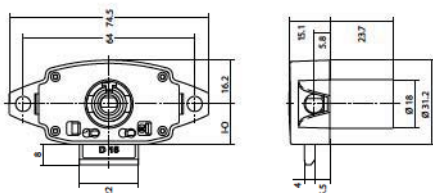

für Wechselzylinder VCS18
und Drehknöpfe 601
bei 19 mm Materialstärke
zum Aufschrauben
Metallguss
vernickelt
VPE 100



Artikelnummer	ehemals	Schließrichtung	Dornmaß
12.0247.VNU.0000	(0247.503.001.0015)	R/L	00 mm ohne Mittelschluss
12.0247.VNU.0015	(0247.501.001.0015)	R/L	15 mm
12.0247.VNU.0020	(0247.502.001.0020)	R/L	20 mm
12.0247.VNU.0025	(0247.551.001.0025)	R/L	25 mm
12.0247.VNU.0030	(0247.552.001.0030)	R/L	30 mm



Berechnung der Stangenlänge

Drehstangenschlösser 0236, 0247, 0248 mit Schließhaken

1262

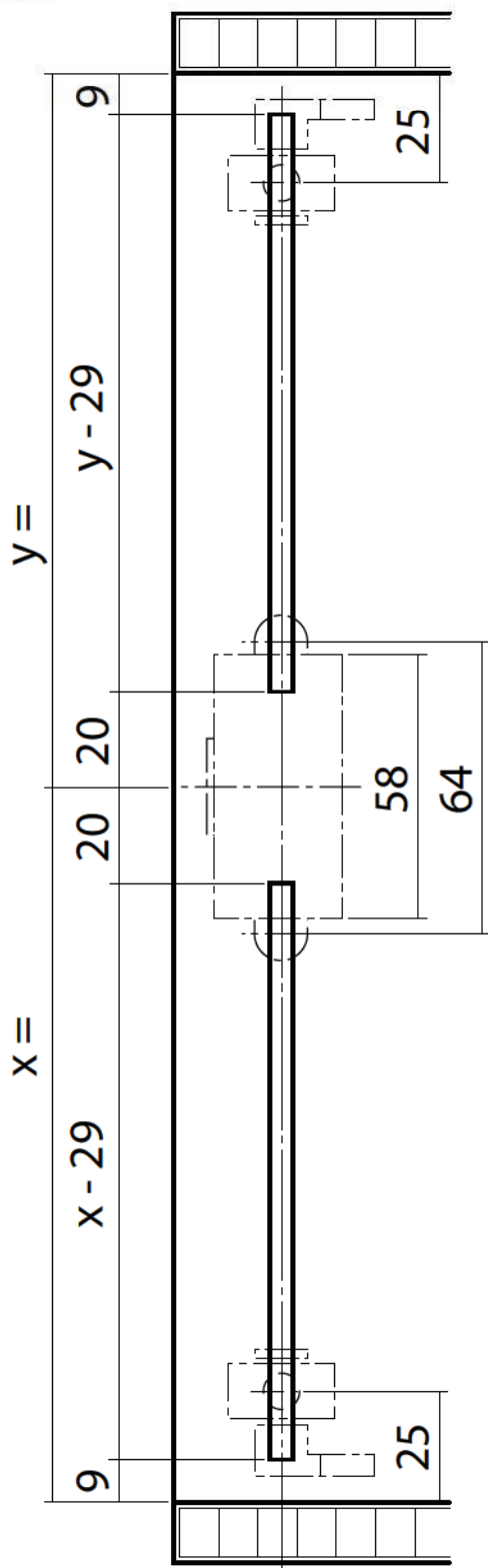

1262 mit Abdeckrand

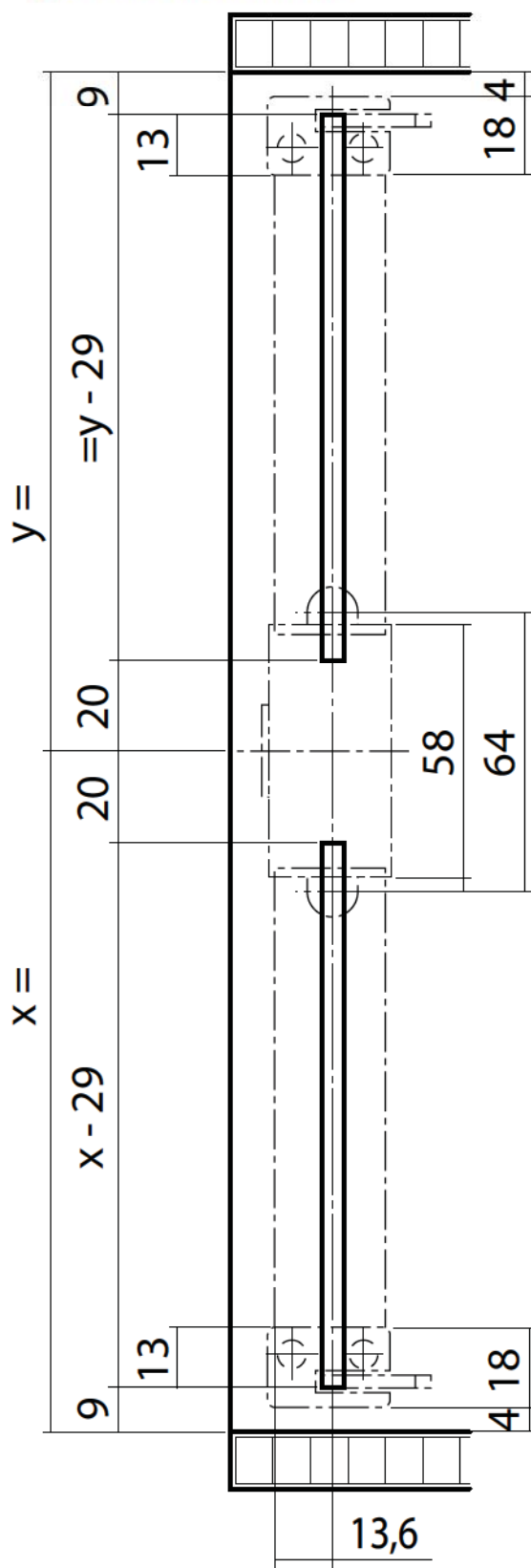

Drehgriff Typ 44.1 P2



für Zylinder Z23
Durchmesser 18 mm
matt vernickelt
VPE 50

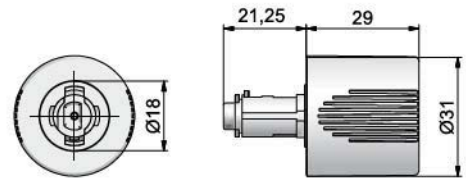

Artikelnummer	ehemals	Schließrichtung
12.0441.PNR.0005	(184410005)	R
12.0441.PNL.0006	(184410006)	L

Drehgriff Typ 47.1 P2



für Zylinder Z23
Durchmesser 18 mm
matt vernickelt
VPE 50

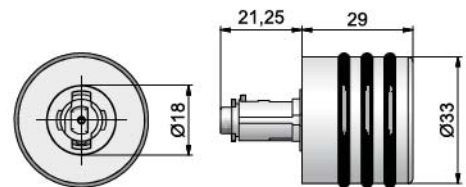

Artikelnummer	ehemals	Schließrichtung
12.0471.PNR.0005	(184710005)	R
12.0471.PNL.0006	(184710006)	L

Demontagestift 500



Stahl
VPE 500

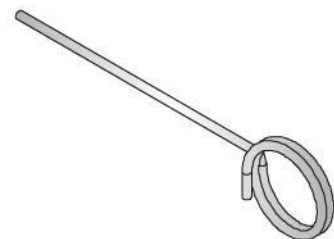

Artikelnummer	ehemals
12.0500.PIO.0000	(500000500)



Drehknopf Typ 0568 VCS18.2

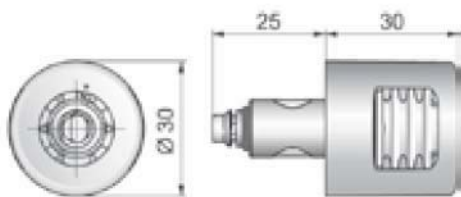

für Wechselzylinder VCS18
für Schlösser VCS18.2
Metallguss
matt vernickelt
VPE 100



Artikelnummer	ehemals	Schließrichtung
12.0568.VNR.0001	(1856860001)	R
12.0568.VNL.0002	(1856860002)	L

Drehknopf Typ 0571 VCS18.2

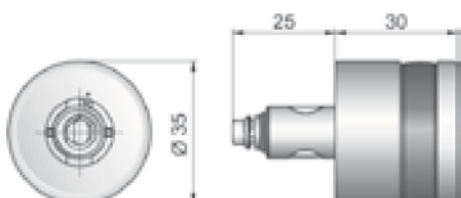

für Wechselzylinder VCS18
für Schlösser VCS18.2
Metallguss
matt vernickelt
VPE 100



Artikelnummer	ehemals	Schließrichtung
12.0571.VNR.0001	(1857160001)	R
12.0571.VNL.0002	(1857160002)	L

Drehknopf Typ 0568 bei Materialstärke 19 mm

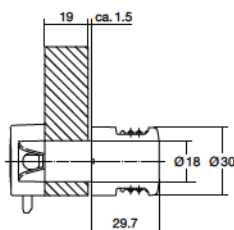

für Wechselzylinder VCS18
für Drehstangenschloss 0247
Metallguss
matt vernickelt
VPE 100



Artikelnummer	ehemals	Schließrichtung
12.0568.VNU.0601	(0568.601.001)	R/L

Drehknopf Typ 0571 bei Materialstärke 19 mm



für Wechselzylinder VCS18
für Drehstangenschloss 0247
Metallguss
matt vernickelt
VPE 100

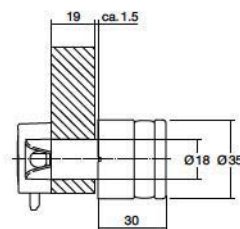

Artikelnummer	ehemals	Schließrichtung
12.0571.VNU.0601	(0571.601.001)	R/L

Drehknopf Typ 0568 bei Materialstärke 16-22 mm



für Wechselzylinder VCS18
für Drehstangenschloss 0248
Metallguss
vernickelt
VPE 100

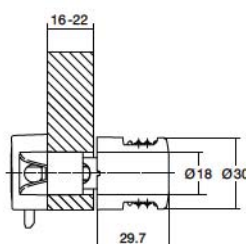

Artikelnummer	ehemals	Schließrichtung
12.0568.KNU.0401	(0568.401.001)	R/L

Drehknopf Typ 0571 bei Materialstärke 16-22 mm



für Wechselzylinder VCS18
für Drehstangenschloss 0248
Metallguss
vernickelt
VPE 100

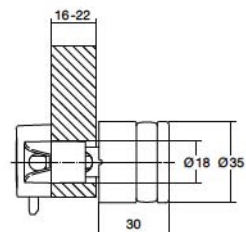

Artikelnummer	ehemals	Schließrichtung
12.0571.KNU.0401	(0571.401.001)	R/L

Abdeckkappe für Zylinderaufnahme



Kunststoff
matt vernickelt
VPE 100

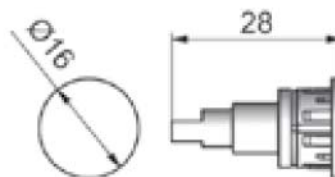

Artikelnummer	ehemals
12.8871.ZNO.0001	(588871001)



Abdeckkappe für Zylinderaufnahme

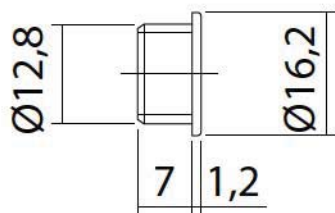

Kunststoff
matt vernickelt
VPE 100



Artikelnummer	ehemals
12.8871.ZNO.0100	(8871.100.001)

Aufbauzylinder Tribolt 22 mm Ø

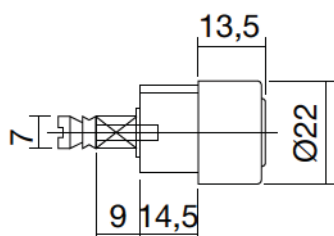

für Wechselzylinder VCS18
Metallguss
matt vernickelt
VPE 100



Artikelnummer	ehemals	Schließrichtung
12.0210.KNU.0551	(0210.551.001)	R/L

Drehknopf Tribolt Typ 0568

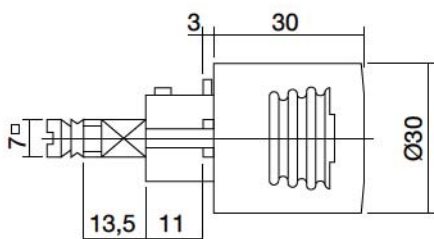

für Wechselzylinder VCS18
Ø 30 mm
Metallguss
matt vernickelt
VPE 50



Artikelnummer	ehemals	Schließrichtung
12.0213.KNR.0501	(0213.501.001)	R
12.0213.KNL.0502	(0213.502.001)	L

Typ 44.1 - 47.1

Zylinderüberstand

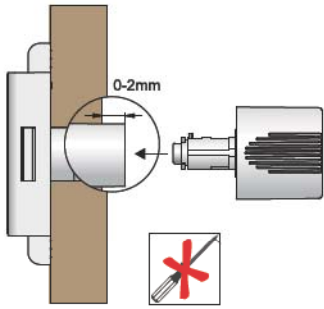

Montage Prestige Drehgriff

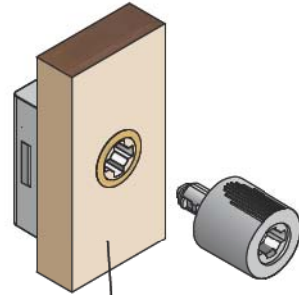

Mit oder ohne Rosette

Demontage Prestige Drehgriff

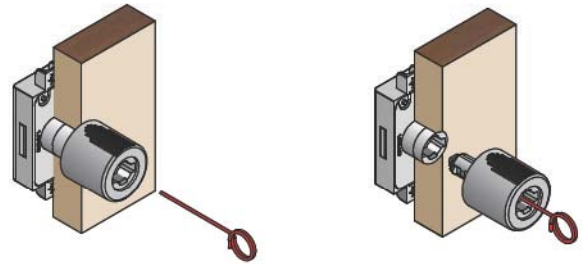

Typ 0568 - 0571

Zylinderüberstand

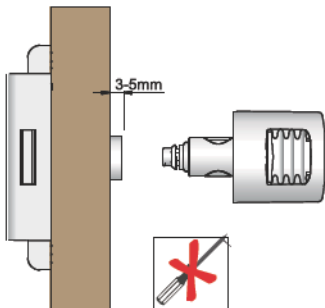

Demontage Drehgriff Typ 0568 / 0571

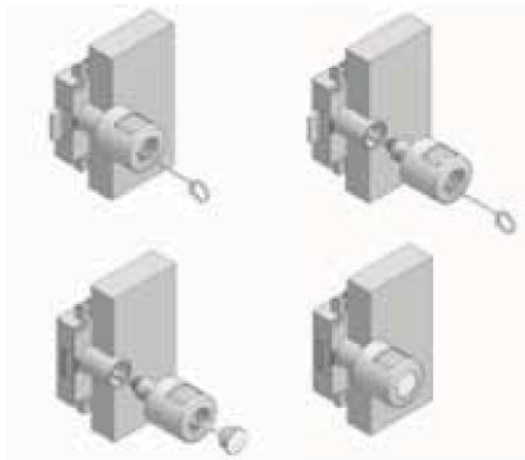

Typ 442.19 - 472.19

Zylinderüberstand

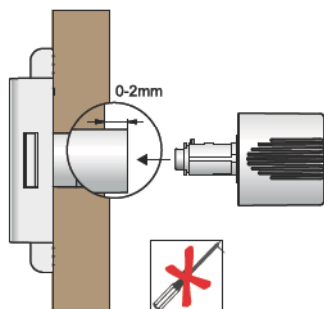

Montage Prestige Drehgriff

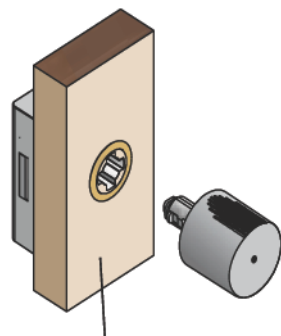

Mit oder ohne Rosette

Demontage Prestige Drehgriff

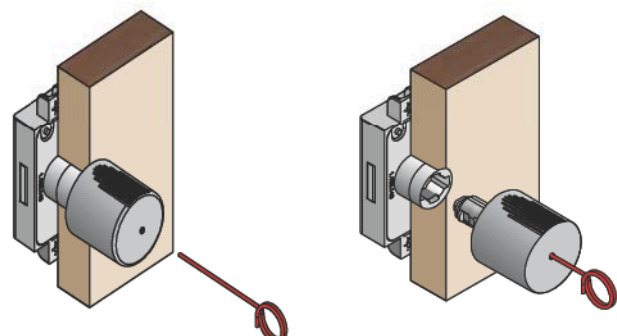



Drehgriff Typ 442.19 P2

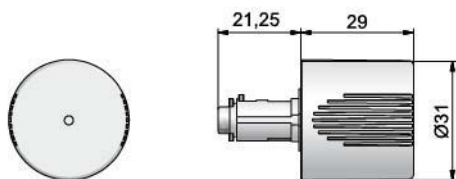

nicht abschließbar (ohne Zylinder)
matt vernickelt
VPE 50



Artikelnummer ehemals
12.0442.PNN.1900 (584421900)

Drehgriff Typ 472.19 P2

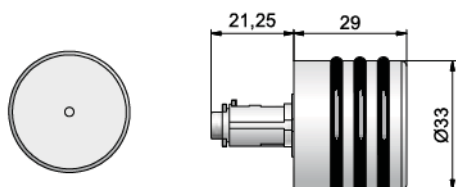

nicht abschließbar (ohne Zylinder)
matt vernickelt
VPE 50



Artikelnummer ehemals
12.0472.PNN.1900 (584721900)

Zierknopf Typ 0568

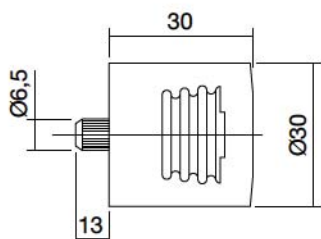

Ø 30 mm
Metallguss
matt vernickelt
VPE 100



Artikelnummer ehemals
12.0568.FNO.8871 (8871.001.001)

Zierknopf Typ 0571

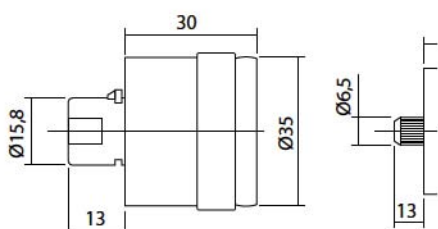

mit schwarzem Ring
Ø 35 mm
Metallguss
matt vernickelt
VPE 100



Artikelnummer ehemals
12.0571.FNO.8902 (8902.001.001)

Zierknopf Typ 444



matt vernickelt
VPE 50

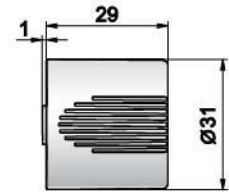
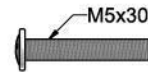

Artikelnummer ehemals
12.0444.FNO.0000 (584440000)

Zierknopf Typ 474

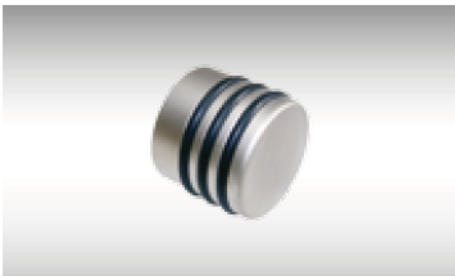

matt vernickelt
VPE 50

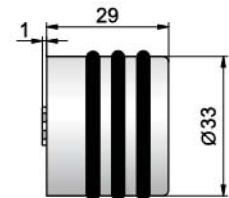
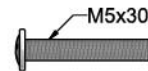

Artikelnummer ehemals
12.0474.FNO.0000 (584740000)

Befestigungsscheibe



zur Zierknopfbefestigung
Bohrung 19 mm
vernickelt
VPE 100

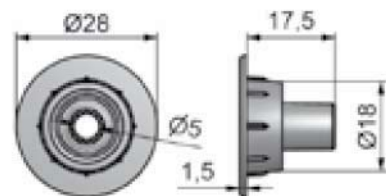

Artikelnummer ehemals
12.9081.ZNO.0001 (9081.001.000)



Rückplatte

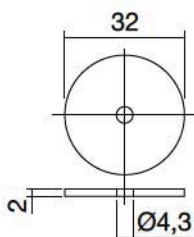

für Zierknopfbefestigung
Metallguss
vernickelt
VPE 100



Artikelnummer ehemals
12.9018.ZNO.0071 (9018.071.000)

Adapter

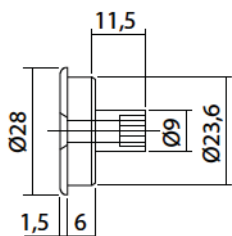

zur Zierknopfbefestigung
Bohrung 24 mm
Metallguss
matt vernickelt
VPE 100



Artikelnummer ehemals
12.9080.ZNO.0001 (9080.001.000)

Senkkopfschraube M4 x 20 mm

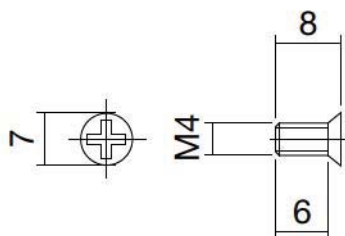

zur Befestigung des Adapters
9080.001.000
Stahl
verzinkt
VPE 100



Artikelnummer ehemals
12.6516.ZZO.0019 (6516.019.015)



Montageanleitung Drehstangenschlösser

mit HUWIL-Schließung

Schloss ist werkseitig in ein DIN Rechts-Schloss eingestellt.
Umstellung des Drehstangenschlosses 0236 in ein DIN Links-Schloss



Bild 1
Bartschlüssel 1 um 180° gegen den Uhrzeigersinn drehen.
Riegel wird rausgeschossen.



Bild 2
Bartschlüssel 1 herausziehen.
Kreuzschlitzschraubendreher 2 auf Einstellschraubenkopf 3 führen.

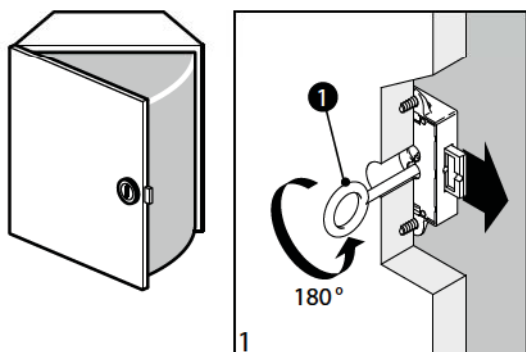

Bild 3
Kreuzschlitzschraubendreher 2 um 180° im Uhrzeigersinn drehen.
Sichtkontrolle 4, Führungsbolzen 5 steht oben.

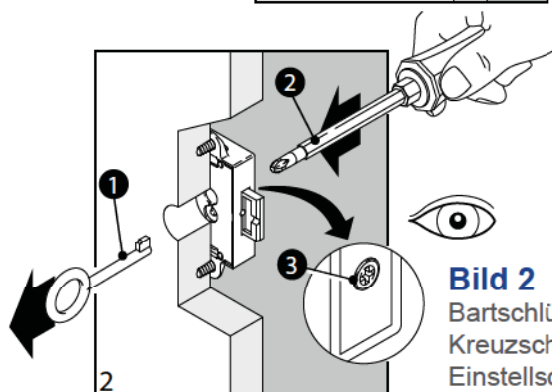

Bild 4
Bartschlüssel 1 ins Schloss stecken, gegen Uhrzeigersinn drehen.
Riegel schließt rein.

DIN Links-Schloss ist eingestellt!

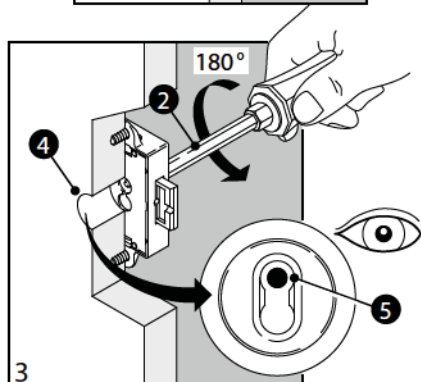

Drehstangenschloss Typ 0236

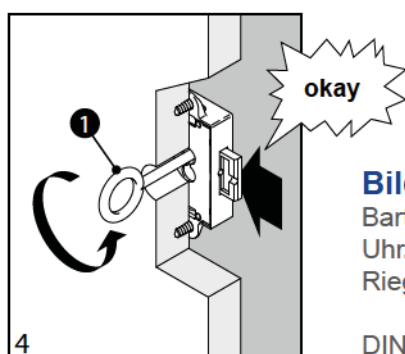
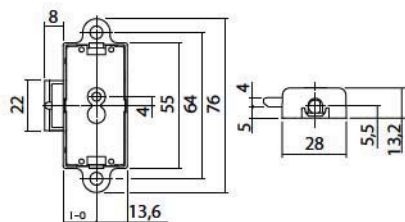

für Bartschlüssel
zum Aufschrauben
Metallguss
brüniert
VPE 100



Artikelnummer	ehemals	Schließrichtung	Dornmaß
12.0236.BBU.0000	(0236.615.000.0015)	R/L	00 mm ohne Mittelschluss
12.0236.BBU.0015	(0236.611.000.0015)	R/L	15 mm
12.0236.BBU.0020	(0236.612.000.0020)	R/L	20 mm
12.0236.BBU.0025	(0236.613.000.0025)	R/L	25 mm
12.0236.BBU.0030	(0236.614.000.0030)	R/L	30 mm

Drehstangenschloss Typ 0236

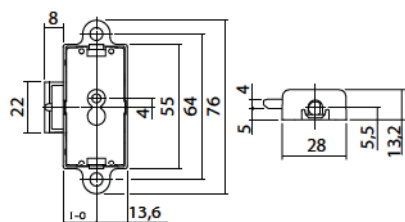

für Bartschlüssel
zum Aufschrauben
Metallguss
vernickelt
VPE 100



Artikelnummer	ehemals	Schließrichtung	Dornmaß
12.0236.BNU.0000	(0236.605.000.0015)	R/L	00 mm ohne Mittelschluss
12.0236.BNU.0015	(0236.601.000.0015)	R/L	15 mm
12.0236.BNU.0020	(0236.602.000.0020)	R/L	20 mm
12.0236.BNU.0025	(0236.603.000.0025)	R/L	25 mm
12.0236.BNU.0030	(0236.604.000.0030)	R/L	30 mm

Drehstangenschloss Typ 700



für Bartschlüssel
zum Aufschrauben
Metallguss
hellbrüniert
VPE 50

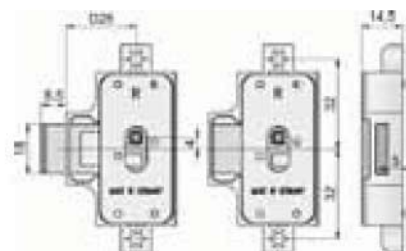

Artikelnummer	ehemals	Schließrichtung	Dornmaß
12.0700.BBR.0000	(137000001)	R	00 mm ohne Mittelschluss
12.0700.BBR.0015	(137000151)	R	15 mm
12.0700.BBR.0020	(137000201)	R	20 mm
12.0700.BBR.0025	(137000251)	R	25 mm
12.0700.BBR.0030	(137000301)	R	30 mm

Drehstangenschloss Typ 700



für Bartschlüssel
zum Aufschrauben
Metallguss
hellbrüniert
VPE 50

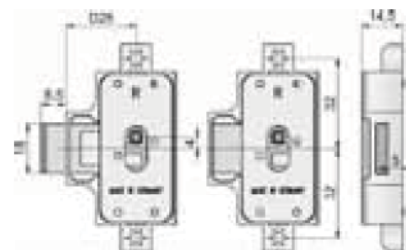

Artikelnummer	ehemals	Schließrichtung	Dornmaß
12.0700.BBL.0000	(137000002)	L	00 mm ohne Mittelschluss
12.0700.BBL.0015	(137000152)	L	15 mm
12.0700.BBL.0020	(137000202)	L	20 mm
12.0700.BBL.0025	(137000252)	L	25 mm
12.0700.BBL.0030	(137000302)	L	30 mm

Drehstangenschloss Typ 700



für Bartschlüssel
zum Aufschrauben
Metallguss
vernickelt
VPE 50

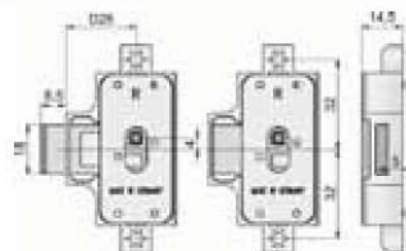

Artikelnummer	ehemals	Schließrichtung	Dornmaß
12.0700.BNR.0000	(147000001)	R	00 mm ohne Mittelschluss
12.0700.BNR.0015	(147000151)	R	15 mm
12.0700.BNR.0020	(147000201)	R	20 mm
12.0700.BNR.0025	(147000251)	R	25 mm
12.0700.BNR.0030	(147000301)	R	30 mm

Befestigungsmaterial wie Muffen und Schrauben bitte separat bestellen.



Drehstangenschloss Typ 700

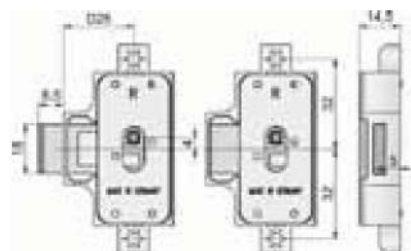

für Bartschlüssel
zum Aufschrauben
Metallguss
vernickelt
VPE 50



Artikelnummer	ehemals	Schließrichtung	Dornmaß
12.0700.BNL.0000	(147000002)	L	00 mm ohne Mittelschluss
12.0700.BNL.0015	(147000152)	L	15 mm
12.0700.BNL.0020	(147000202)	L	20 mm
12.0700.BNL.0025	(147000252)	L	25 mm
12.0700.BNL.0030	(147000302)	L	30 mm

Drehstangenschloss Typ 0235

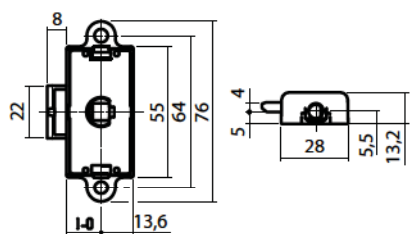

mit Vierkantaufnahme
zum Aufschrauben
Metallguss
vernickelt
VPE 100



Artikelnummer	ehemals	Schließrichtung	Dornmaß
12.0235.KNU.0015	(0235.101.000.0015)	R/L	15 mm

Drehstangenschloss Typ 707.8

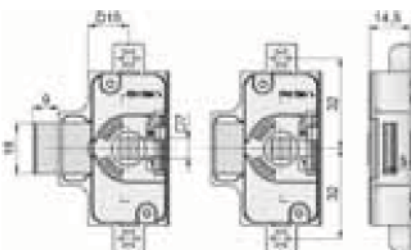

mit Vierkantaufnahme
zum Aufschrauben
Metallguss
hellbrüniert
VPE 50



Artikelnummer	ehemals	Schließrichtung	Dornmaß
12.0700.KBU.0000	(137007008)	R/L	00 mm ohne Mittelschluss
12.0700.KBU.0015	(137007158)	R/L	15 mm
12.0700.KBU.0020	(137007208)	R/L	20 mm
12.0700.KBU.0025	(137007258)	R/L	25 mm
12.0700.KBU.0030	(137007308)	R/L	30 mm

Befestigungsmaterial wie Muffen und Schrauben bitte separat bestellen.

Drehstangenschloss Typ 707.8



mit Vierkantaufnahme
zum Aufschrauben
Metallguss
vernickelt
VPE 50

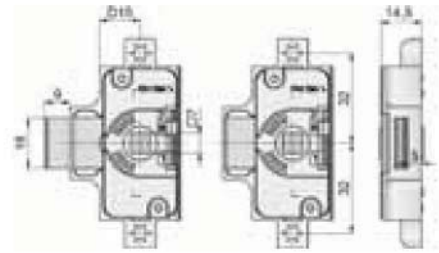

Artikelnummer	ehemals	Schließrichtung	Dornmaß
12.0700.KNU.0000	(147007008)	R/L	00 mm ohne Mittelschluss
12.0700.KNU.0015	(147007158)	R/L	15 mm
12.0700.KNU.0020	(147007208)	R/L	20 mm
12.0700.KNU.0025	(147007258)	R/L	25 mm
12.0700.KNU.0030	(147007308)	R/L	30 mm

Einleimdrehgriff 722



VPE 250

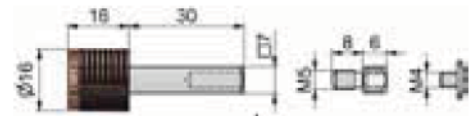

Artikelnummer	ehemals
12.0722.ZUO.0000	(507220000)

Laufbuchse 711



weiß
VPE 250

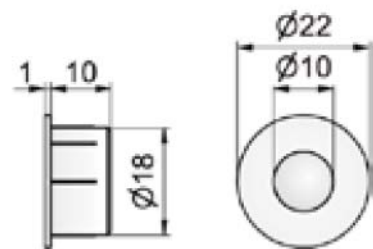

Artikelnummer	ehemals
12.0740.ZWO.7110	(577407110)



Drehstange Typ 1232, 6 x 5 mm



für Drehstangenschlösser
Stahl
VPE 50



Artikelnummer	ehemals	Oberfläche	Gesamtlänge
12.1232.ZBO.1000	(1232.817.000.1000)	hellbrüniert	1000 mm
12.1232.ZBO.1200	(1232.817.000.1200)	hellbrüniert	1200 mm
12.1232.ZBO.2000	(1232.817.000.2000)	hellbrüniert	2000 mm
12.1232.ZNO.1000	(1232.802.000.1000)	vernickelt	1000 mm
12.1232.ZNO.1200	(1232.802.000.1200)	vernickelt	1200 mm
12.1232.ZNO.2000	(1232.802.000.2000)	vernickelt	2000 mm

Drehstange Typ 1233, 8 x 7 mm



für Drehstangenschlösser
Stahl
vernickelt
VPE 25



Artikelnummer	ehemals	Gesamtlänge
12.1233.ZNO.1200	(1233.802.000.1200)	1200 mm
12.1233.ZNO.2000	(1233.802.000.2000)	2000 mm

Schließhaken 467 & 468

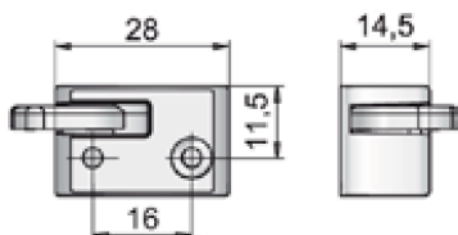

mit Rand für Abdeckleiste
zum Anschrauben
VPE 50



Artikelnummer	ehemals	Schließrichtung	Oberfläche
12.0710.ZBR.0467	(537104670)	R oben/L unten	hellbrüniert
12.0710.ZBL.0468	(537104680)	L oben/R unten	hellbrüniert
12.0710.ZNR.0467	(547104670)	R oben/L unten	vernickelt
12.0710.ZNL.0468	(547104680)	L oben/R unten	vernickelt

Schließhaken dübelbar 467.9 & 468.9



mit Rand für Abdeckleiste
zum Einpressen
VPE 50

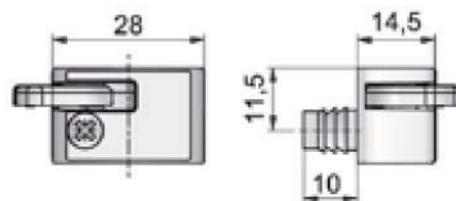

Artikelnummer	ehemals	Schließrichtung	Oberfläche
12.0719.ZBR.0467	(537194670)	R oben/L unten	hellbrüniert
12.0719.ZBL.0468	(537194680)	L oben/R unten	hellbrüniert
12.0719.ZNR.0467	(547194670)	R oben/L unten	vernickelt
12.0719.ZNL.0468	(547194680)	L oben/R unten	vernickelt

Schließhaken 161.3 & 162.3



zum Anschrauben
VPE 500

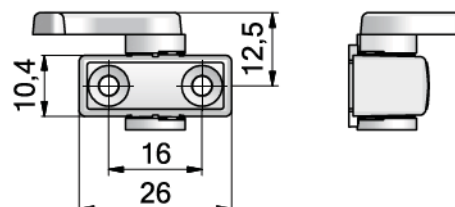

Artikelnummer	ehemals	Schließrichtung	Oberfläche
12.0740.ZBR.1613	(537401613)	R oben/L unten	hellbrüniert
12.0740.ZBL.1623	(537401623)	L oben/R unten	hellbrüniert
12.0740.ZNR.1613	(547401613)	R oben/L unten	vernickelt
12.0740.ZNL.1623	(547401623)	L oben/R unten	vernickelt

Schließhaken dübelbar 161.1 & 162.1



zum Einpressen
VPE 500

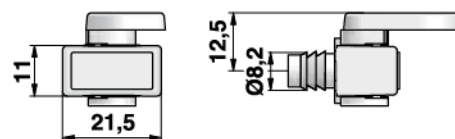

Artikelnummer	ehemals	Schließrichtung	Oberfläche
12.0749.ZBR.1611	(537491611)	R oben/L unten	hellbrüniert
12.0749.ZBL.1621	(537491621)	L oben/R unten	hellbrüniert
12.0749.ZNR.1611	(547491611)	R oben/L unten	vernickelt
12.0749.ZNL.1621	(547491621)	L oben/R unten	vernickelt



Schließhaken Typ 1262 mit Endschleife und Kappe

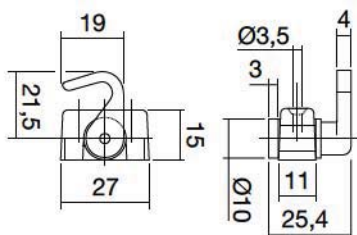

für Drehstangenschlösser
ohne Abdeckleiste
zum Aufschrauben
Metallguss
VPE 100



Artikelnummer	ehemals	Schließrichtung	Oberfläche
12.1262.ZBR.0141	(1262.141.000)	R oben/L unten	brüniert
12.1262.ZBL.0142	(1262.142.000)	L oben/R unten	brüniert
12.1262.ZNR.0083	(1262.083.000)	R oben/L unten	vernickelt
12.1262.ZNL.0084	(1262.084.000)	L oben/R unten	vernickelt

Schließhaken Typ 1262 mit Endschleife und Kappe

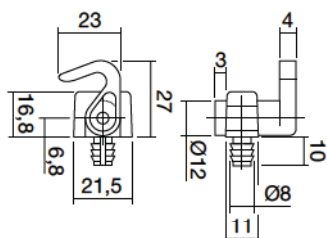

für Drehstangenschlösser
ohne Abdeckleiste
zum Einpressen
Metallguss
VPE 100



Artikelnummer	ehemals	Schließrichtung	Oberfläche
12.1262.ZBR.0283	(1262.283.000)	R oben/L unten	brüniert
12.1262.ZBL.0284	(1262.284.000)	L oben/R unten	brüniert
12.1262.ZNR.0263	(1262.263.000)	R oben/L unten	vernickelt
12.1262.ZNL.0264	(1262.264.000)	L oben/R unten	vernickelt

Schließhaken Typ 1262 mit Endschleife und Kappe

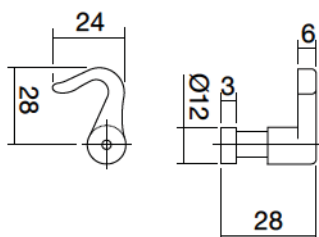

für Drehstangen 8 mm
zum Aufschrauben
Metallguss vernickelt
Kunststoff schwarz
VPE 100



Artikelnummer	ehemals	Schließrichtung
12.1262.ZNR.0401	(1262.401.000)	R oben/L unten
12.1262.ZNL.0402	(1262.402.000)	L oben/R unten

Schließhaken Typ 1264 mit Endschleufe



für Drehstangenschlösser
mit Abdeckleiste
zum Aufschrauben
Metallguss
VPE 100

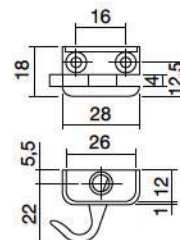

Artikelnummer	ehemals	Schließrichtung	Oberfläche
12.1264.ZBR.0003	(1264.003.000)	R oben/L unten	brüniert
12.1264.ZBL.0004	(1264.004.000)	L oben/R unten	brüniert
12.1264.ZNR.0051	(1264.051.000)	R oben/L unten	vernickelt
12.1264.ZNL.0052	(1264.052.000)	L oben/R unten	vernickelt

Schließhaken Typ 1264 mit Endschleufe



für Drehstangenschlösser
mit Abdeckleiste
zum Einpressen
Metallguss
VPE 100

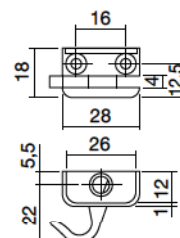

Artikelnummer	ehemals	Schließrichtung	Oberfläche
12.1264.ZNR.0011	(1264.011.000)	R oben/L unten	vernickelt
12.1264.ZNL.0012	(1264.012.000)	L oben/R unten	vernickelt
12.1264.ZBR.0013	(1264.013.000)	R oben/L unten	brüniert
12.1264.ZBL.0014	(1264.014.000)	L oben/R unten	brüniert

Leistenklammer 464



für Abdeckleiste
zum Einpressen
Kunststoff
schwarz
VPE 50

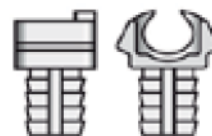

Artikelnummer	ehemals
12.0710.ZSO.0464	(567104640)



Stangenführung 065.2

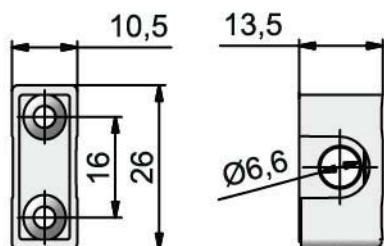

zum Anschrauben
VPE 1000



Artikelnummer	ehemals	Oberfläche
12.0740.ZBO.0652	(537400652)	hellbrüniert
12.0740.ZNO.0652	(547400652)	vernickelt

Stangenführung dübelbar 071

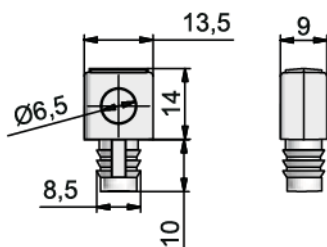

zum Einpressen
VPE 1000



Artikelnummer	ehemals	Oberfläche
12.0749.ZBO.0710	(537490710)	hellbrüniert
12.0749.ZNO.0710	(547490710)	vernickelt

Mittelschleife mit Abdeckkappe

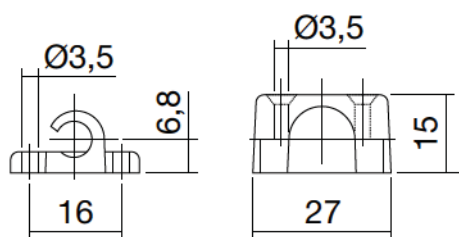

für Drehstangenschlösser
ohne Abdeckleiste
zum Aufschrauben
Metallguss
VPE 100



Artikelnummer	ehemals	Oberfläche
12.1224.ZBO.0014	(1224.014.000)	brüniert
12.1224.ZNO.0011	(1224.011.000)	vernickelt

Endschlaufe mit Abdeckkappe für Drehstangen 6 mm



auch Mittelschlaufe
für Drehstangen 8 mm
zum Aufschrauben
Metallguss / Kunststoff
VPE 100

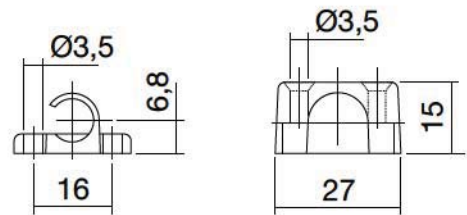

Artikelnummer	ehemals	Oberfläche
12.1225.ZBO.0014	(1225.020.000)	brüniert / Brüniert
12.1225.ZNO.0011	(1225.011.000)	vernickelt / weiß

Anschlagstift 051



vernickelt
VPE 500

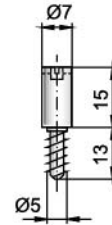

Artikelnummer	ehemals
12.0750.ZNO.0510	(547500510)

Anschlagstift 054



vernickelt
VPE 500

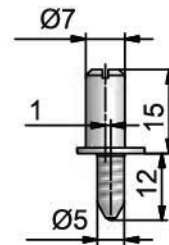

Artikelnummer	ehemals
12.0750.ZNO.0540	(547500540)

Anschlagstift 055



vernickelt
VPE 500

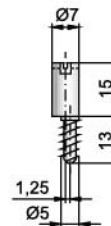

Artikelnummer	ehemals
12.0750.ZNO.0550	(547500550)



Anschlagstift 057

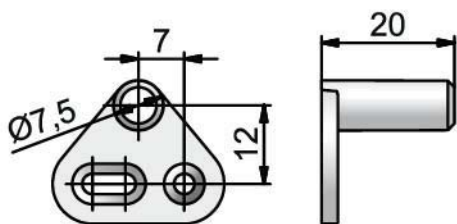

zum Anschrauben
VPE 250



Artikelnummer	ehemals	Oberfläche
12.0750.ZBO.0570	(537500570)	hellbrüniert
12.0750.ZNO.0570	(547500570)	vernickelt

Anschlagstift 058

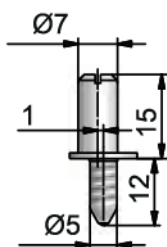

vernickelt
VPE 500



Artikelnummer	ehemals
12.0750.ZNO.0580	(547500580)

Stahl-Anschlag mit M6 Gewinde

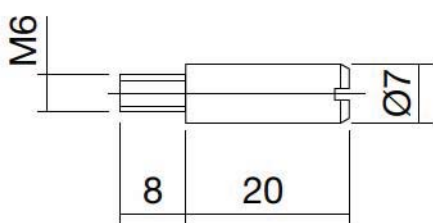

zentrisch
Stahl
vernickelt
VPE 100



Artikelnummer	ehemals
12.1337.ZNO.0001	(1337.001.002)

Stahl-Anschlag mit M6 Gewinde

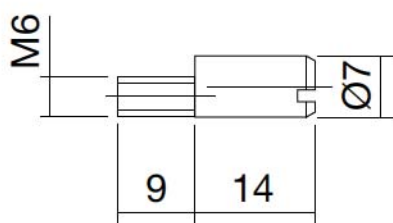

exzentrisch
Stahl
vernickelt
VPE 100



Artikelnummer	ehemals
12.1338.ZNO.0004	(1338.004.000)

Stahl-Anschlag mit Spanplattengewinde



exzentrisch
Stahl
vernickelt
VPE 100

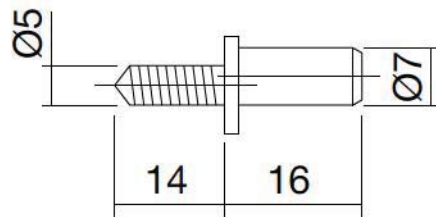

Artikelnummer	ehemals
12.1338.ZNO.0023	(1338.023.000)

Metallguss-Anschlag



Metallguss
VPE 100

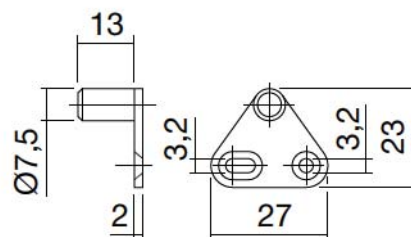

Artikelnummer	ehemals	Oberfläche
12.1339.ZBO.0009	(1339.009.000)	brüniert
12.1339.ZZO.0001	(1339.001.000)	verzinkt

Metallguss-Anschlag mit Wendeanschlag für 15 und 25 mm Dornmaß



Metallguss
vernickelt
VPE 100

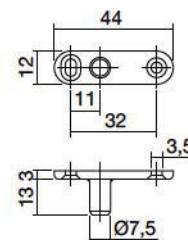

Artikelnummer	ehemals
12.1357.ZNO.0001	(1357.001.000)

Muffe M6 052



Kunststoff
naturfarben
VPE 500

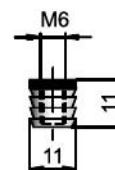

Artikelnummer	ehemals
12.0750.ZKO.0520	(507500520)



Verbindungsplatte für Drehstangenschloss Typ 0238

zum Anschrauben
Metallguss
unveredelt
VPE 100



Artikelnummer	ehemals	Schließrichtung
12.0238.ZUU.4001	(0238.400.001)	R/L

Verbindungsplatte für Drehstangenschloss Typ 0275

(früher Kunststoff weiß)
zum Anschrauben
Metallguss
unveredelt
VPE 100



Artikelnummer	ehemals	Schließrichtung
12.0724.ZUR.0002	(0724.002.002)	R

Verbindungsplatte für Drehstangenschloss Typ 0275

zum Anschrauben
Kunststoff
schwarz
VPE 100



Artikelnummer	ehemals	Schließrichtung
12.0724.ZSL.0053	(0724.002.053)	L

Verbindungsplatte für Drehstangenschloss Typ 0238, 1. Generation

zum Clipsen
Kunststoff
schwarz
VPE 100



Artikelnummer	ehemals	Schließrichtung
12.0238.ZSU.3001	(0238.300.001)	R/L



Drehstangenschlösser

Senkkopfschraube Gewinde M2, 5 x 14 mm, mit Kreuzschlitz

Stahl
verzinkt
VPE 500



Artikelnummer	ehemals
18.8238.ZZO.0033	(8238.033.000)

Muffe M6 Innengewinde

für Drehstangenschlösser
naturfarben
VPE 100

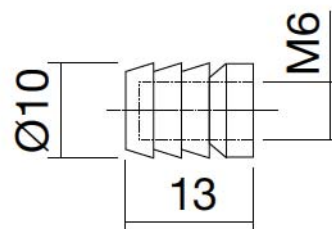
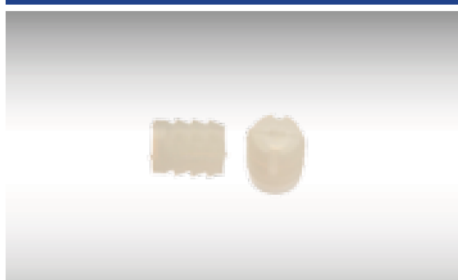

Artikelnummer	ehemals
12.2618.ZKO.0003	(2618.003.001)



Typ 204

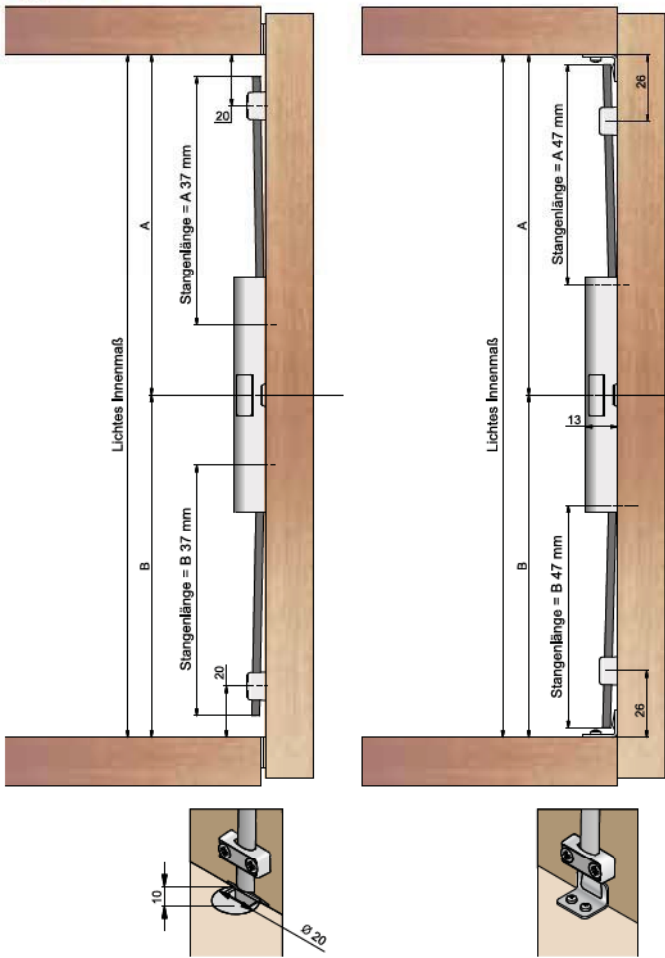

Typ 292

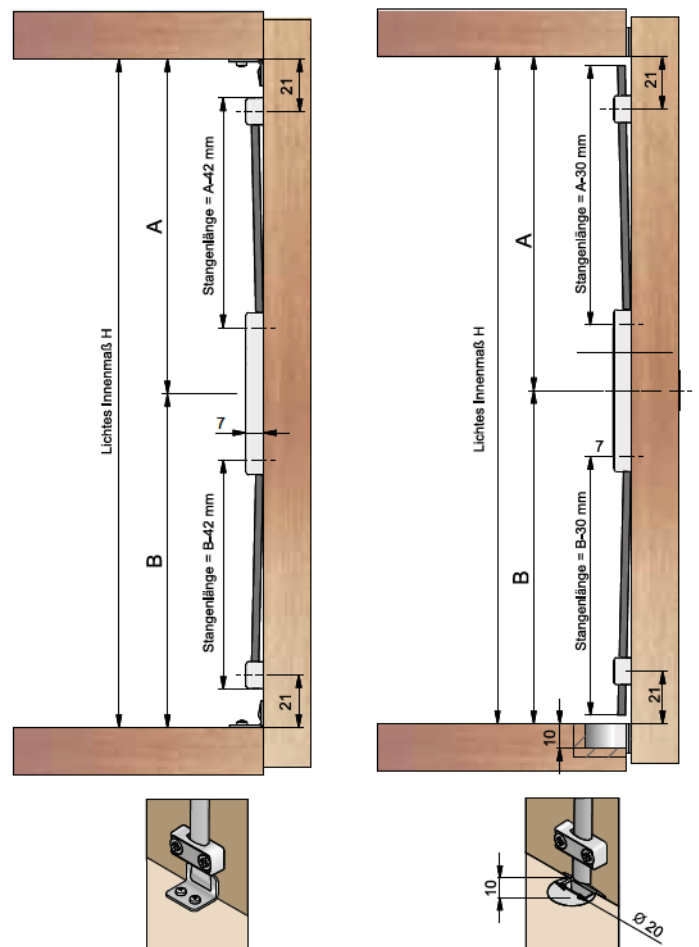

Schubstangenschloss Typ 204 P2



für Zylinder Z23
mit Mittelschluss
zum Aufschrauben
Metallguss
vernickelt
VPE 100

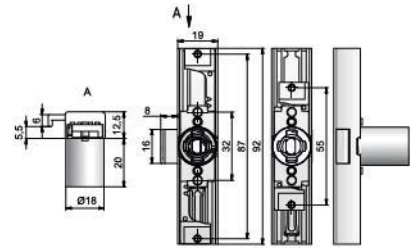

Artikelnummer	ehemals	Schließrichtung
12.0204.PNR.0001	(1420422001)	R
12.0204.PNL.0002	(1420422002)	L

Schubstangenschloss Typ 0204 VCS18.2



für Wechselzylinder VCS18
zum Aufschrauben
Metallguss
vernickelt
VPE 100

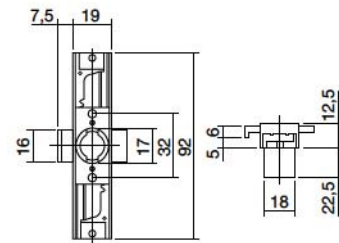

Artikelnummer	ehemals	Schließrichtung	
12.0204.VNR.0501	(0204.501.001)	R	mit Mittelschluss
12.0204.VNL.0002	(1420463002)	L	mit Mittelschluss
12.0204.VNR.0511	(0204.511.001)	R	ohne Mittelschluss

Schubstangenschloss Typ 0205 VCS18.2



für Wechselzylinder VCS18
zum Aufschrauben
Metallguss
vernickelt
VPE 100

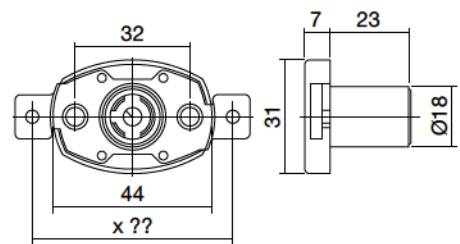

Artikelnummer	ehemals	Schließrichtung	Montage
12.0205.VNR.0501	(0205.501.001)	R	vertikal und horizontal



Schubstangenschloss Typ 0207 VCS18.2

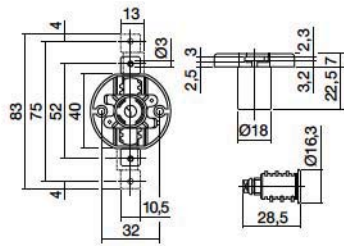

für Wechselzylinder VCS18
zum Aufschrauben
Metallguss
vernickelt
VPE 100



Artikelnummer	ehemals	Schließrichtung	Montage
12.0207.VNO.0501	(0207.501.001)	R	horizontal
12.0207.VNO.0551	(0207.551.001)	R	vertikal

Schubstangenschloss Typ 292 P2

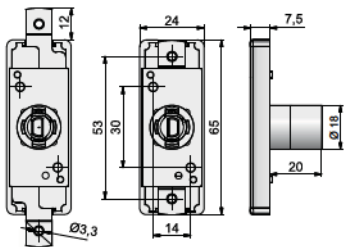

für Zylinder Z23
zum Aufschrauben
vernickelt
VPE 50



Artikelnummer	ehemals	Schließrichtung
12.0292.PNR.0005	(142972005)	R
12.0292.PNL.0006	(142972006)	L
12.0292.PND.0007	(142972007)	lad

Schubstangenschloss Typ 292 VCS18.2

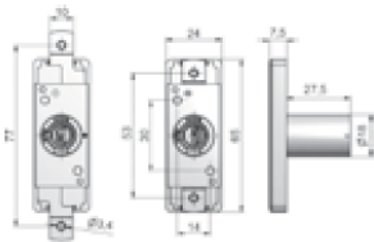

für Wechselzylinder VCS18
zum Aufschrauben
vernickelt
VPE 50



Artikelnummer	ehemals	Schließrichtung
12.0292.VNR.0005	(1429767001)	R
12.0292.VNL.0006	(1429767002)	L
12.0292.VND.0007	(1429767003)	lad

Schubstangenschlösser

Schubstange massiv 043, halbrund 10 x 3 mm, beidseitig gelocht



Stahl
vernickelt
VPE 50



Artikelnummer	ehemals	Gesamtlänge
12.1237.ZNB.0600	(540600431)	600 mm
12.1237.ZNB.1000	(541000431)	1000 mm

Schubstange massiv 043, halbrund 10 x 3 mm, einseitig gelocht

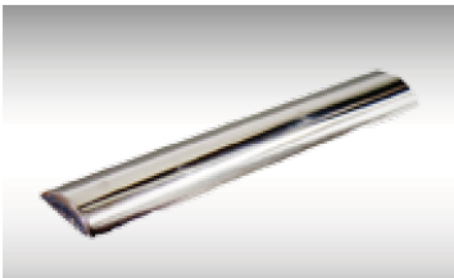

Stahl
vernickelt
VPE 50



Artikelnummer	ehemals	Gesamtlänge
12.1237.ZNE.0600	(540600430)	600 mm
12.1237.ZNE.0800	(540800430)	800 mm
12.1237.ZNE.1000	(1237.805.000.1000)	1000 mm
12.1237.ZNE.1500	(1237.805.000.1500)	1500 mm

Stangenführung 041



zum Anschrauben
vernickelt
VPE 250

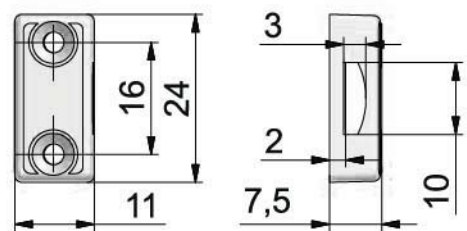

Artikelnummer	ehemals
12.0292.ZNO.0410	(542920410)



Führungsschleufe

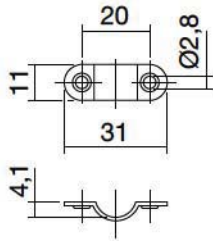

für Schubstangen
zum Aufschrauben
Stahl
vernickelt
VPE 100



Artikelnummer ehemals
12.1211.ZNO.0001 (1211.001.000)

Aufsteckriegel

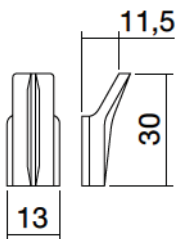

für Schubstangen
Kunststoff
schwarz
VPE 100



Artikelnummer ehemals
12.0863.ZSO.0003 (0863.003.000)

Lagertopf 037

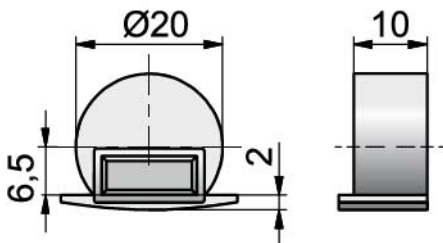

zum Einpressen
vernickelt
VPE 100



Artikelnummer ehemals
12.0292.ZNO.0370 (442920370)

Schließbuchse



für Schubstangen
Kunststoff
schwarz
VPE 100

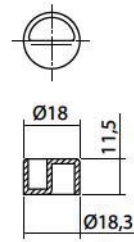

Artikelnummer ehemals
12.1176.ZSO.0003 (1176.003.000)

Anschlagwinkel 2211



zum Anschrauben
vernickelt
VPE 250

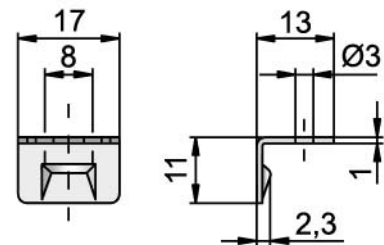

Artikelnummer ehemals
12.2211.ZNO.0430 (442211430)



Hinterlegeschlösser

Inhalt

Hinterlegeschlösser für Zylinder

Hinterlegeschlösser für Bartschlüssel

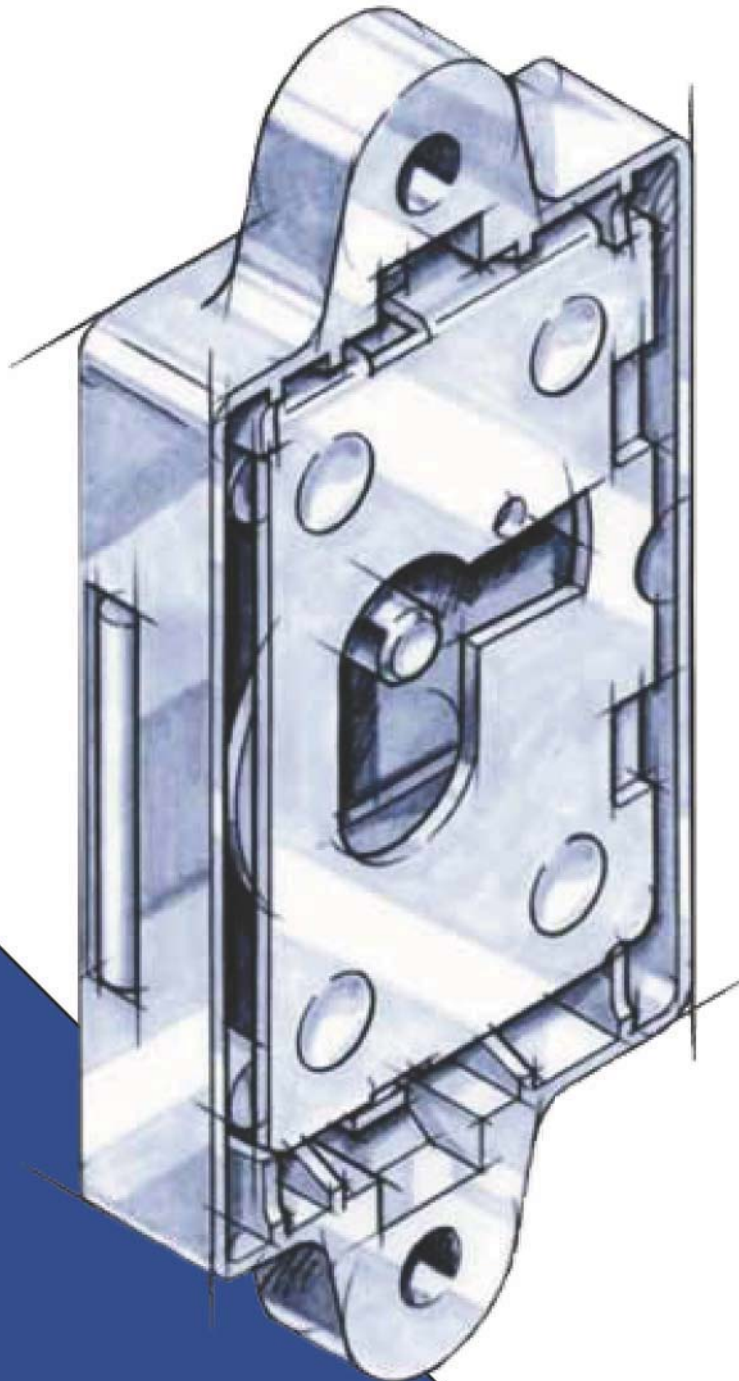

Hinterlegschloss Typ 0425 VCS18.2



für Wechselzylinder VCS18
zum Aufschrauben
Metallguss
vernickelt
VPE 100

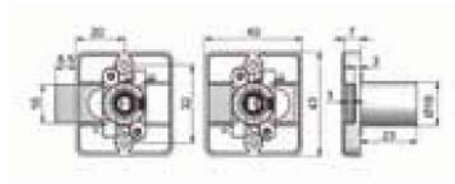

Artikelnummer	ehemals	Dornmaß	Schließrichtung
13.0425.VNR.0020	(0425.501.001.0020)	20 mm	R
13.0425.VNL.0020	(0425.502.001.0020)	20 mm	L
13.0425.VND.0020	(0425.507.001.0020)	20 mm	lad

Kastenschloss Typ 391 P2



für Zylinder Z23
zum Aufschrauben
vernickelt
VPE 50

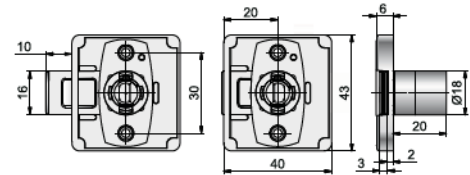

Artikelnummer	ehemals	Dornmaß	Schließrichtung
13.0391.PNR.0020	(143972005)	20 mm	R
13.0391.PNL.0020	(143972006)	20 mm	L
13.0391.PND.0020	(143972007)	20 mm	lad

Hinterlegschloss Typ 0425



mit Zylinder 16,5 mm
zum Aufschrauben
Metallguss
vernickelt
VPE 100

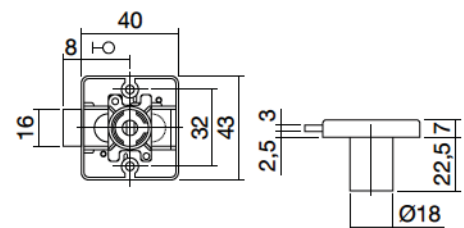

Artikelnummer	ehemals	Dornmaß	Schließrichtung
13.0425.FNR.0009	(0425.201.000.0009)	9 mm	R
13.0425.FNL.0009	(0425.202.000.0009)	9 mm	L



Hinterlegeschlösser

Typ 550

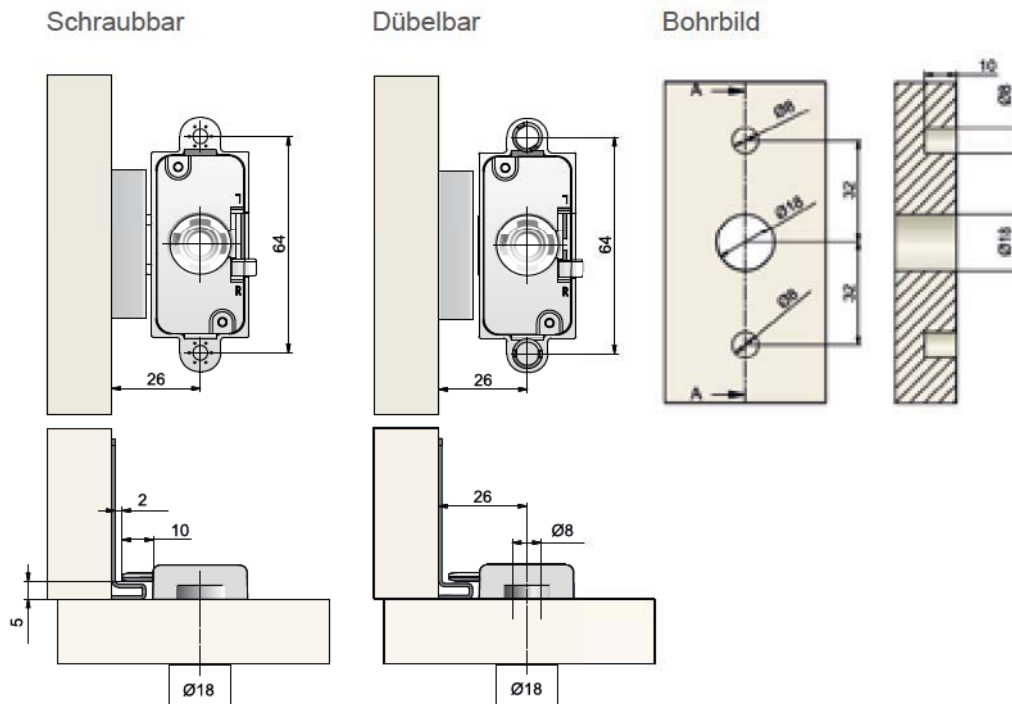

Schlüsselabzugssperre integriert

Typ 660

Dornmaß verstellen

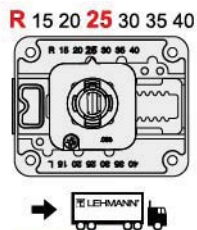

Ab Werk
Dornmaß 25

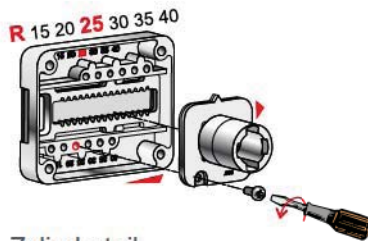

Zylinderteil
demonstrieren

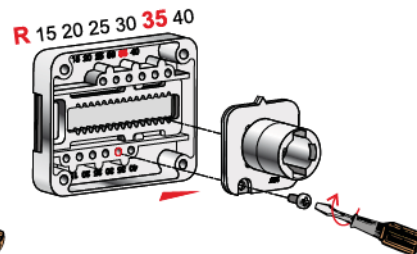

Dornmaß wählen, Zylinderteil montieren

Einstellen, rechts oder links

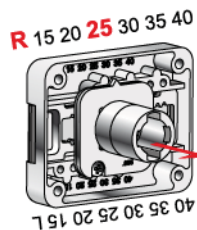

Zylinderteil
demonstrieren

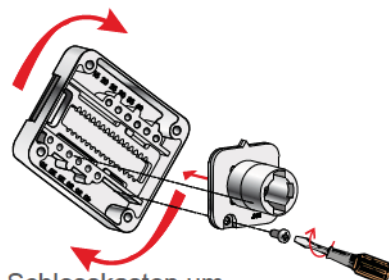

Schlosskasten um
180° drehen,
Dornmaß wählen u.
Zylinderteil montieren

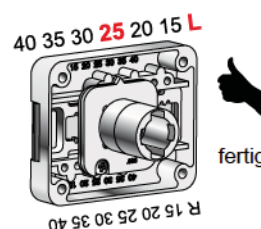
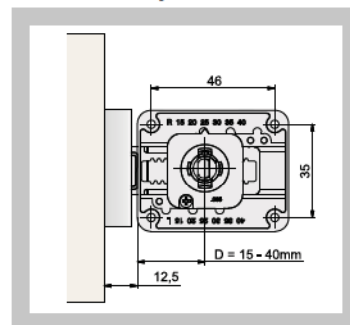



Hinterlegeschloss Typ 660 VCS 18.2 (Kastenschloss)

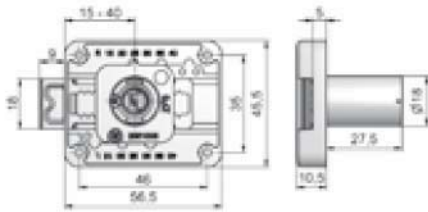

für Wechselzylinder VCS18
Zylinderlänge 27,5 mm
zum Aufschrauben
vernickelt
VPE 50



Artikelnummer	ehemals	Dornmaß	Schließrichtung
13.0660.VNU.1540	(1466067400)	15-40 mm	R/L

Hinterlegeschloss Typ 660 P2 (Kastenschloss)

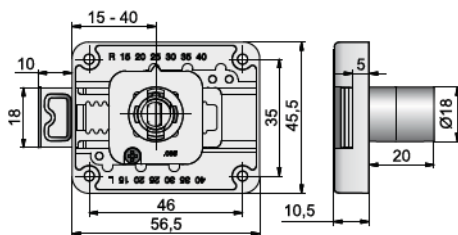

für Zylinder Z23
Zylinderlänge 20 mm
zum Aufschrauben
vernickelt
VPE 50



Artikelnummer	ehemals	Dornmaß	Schließrichtung
13.0660.PNU.1540	(146602405)	15-40 mm	R/L

Schnäpperschloss Typ 584 VCS18.2

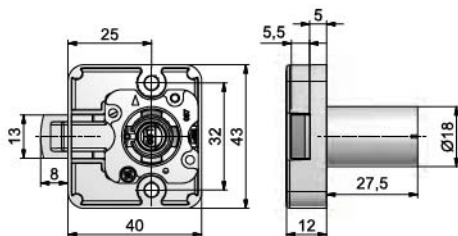

für Wechselzylinder VCS18
zum Aufschrauben
vernickelt
VPE 50



Artikelnummer	ehemals	Dornmaß	Schließrichtung
13.0584.VNR.0025	(1458467251)	25 mm	R
13.0584.VNL.0025	(1458467252)	25 mm	L

Schnäpperschloss Typ 584 P2

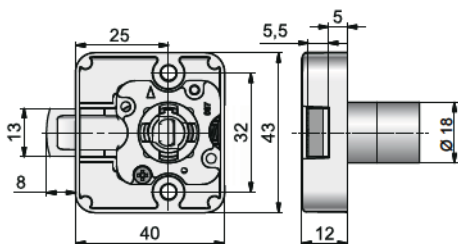

für Zylinder Z23
zum Aufschrauben
vernickelt
VPE 50



Artikelnummer	ehemals	Dornmaß	Schließrichtung
13.0584.PNR.0025	(145842255)	25 mm	R
13.0584.PNL.0025	(145842256)	25 mm	L

Aufschraubverschluss Typ 0192 VCS18.2 mit Doppelhakenriegel



für Wechselzylinder VCS18
zum Aufschrauben
Metallguss
matt vernickelt
VPE 100

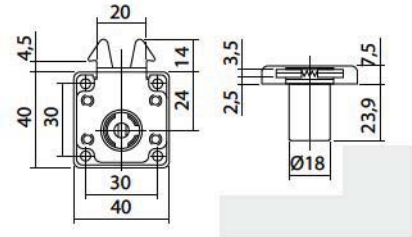

Artikelnummer	ehemals	Schließrichtung
13.0192.VNO.0501	(0192.501.001)	R/lad

Schließblech 1182

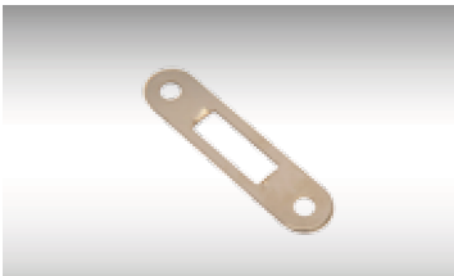

Stahl
vernickelt
VPE 100

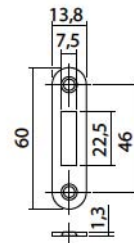

Artikelnummer	ehemals
13.1182.ZNO.0001	(1182.001.000)

Hinterlegeschloss Typ 0489 VCS18.2



für Wechselzylinder VCS18
zum Aufschrauben
Metallguss / Kunststoff
vernickelt
VPE 200

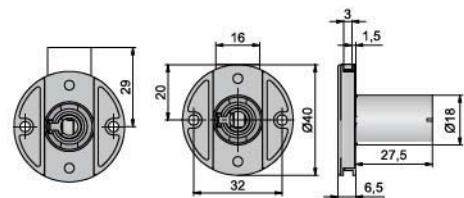

Artikelnummer	ehemals	Schließrichtung	Riegel
13.0489.VNR.0069	(0489.501.001)	R/lad	69 mm
13.0489.VNR.0036	(0489.540.001)	R/lad	36 mm



Hinterlegeschloss Typ 0405 (Kastenschloss)

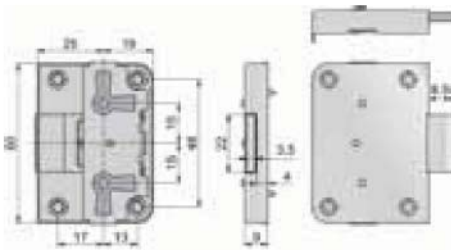

Riegelabstand 4 mm
zum Aufschrauben
Stahl
vernickelt
VPE 200



Artikelnummer	ehemals	Dornmaß	Schließrichtung
13.0405.BNU.0015	(0405.045.000.0015)	15 mm	R/lad L/lad
13.0405.BNU.0020	(0405.017.000.0020)	20 mm	R/lad L/lad
13.0405.BNU.0025	(0405.022.000.0025)	25 mm	R/lad L/lad
13.0405.BNU.0030	(0405.018.000.0030)	30 mm	R/lad L/lad
13.0405.BNU.0035	(0405.023.000.0035)	35 mm	R/L
13.0405.BNU.0040	(0405.024.000.0040)	40 mm	R/lad L/lad

Hinterlegeschloss Typ 0405 (Kastenschloss)

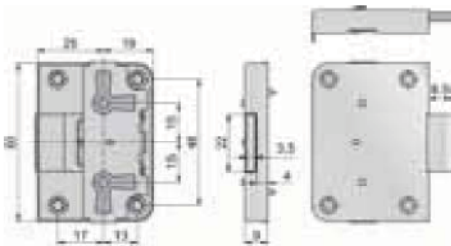

zum Aufschrauben
brüniert
VPE 100

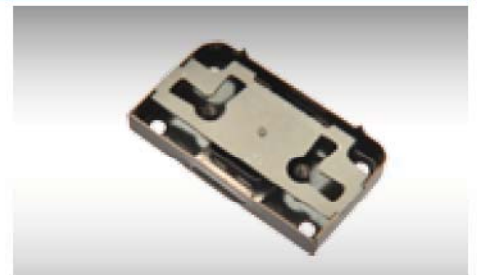

Artikelnummer	ehemals	Dornmaß	Schließrichtung
13.0405.BBU.0015	(160405015)	15 mm	R/L
13.0405.BBU.0020	(160405020)	20 mm	R/L
13.0405.BBU.0025	(160405025)	25 mm	R/L
13.0405.BBU.0030	(160405030)	30 mm	R/L
13.0405.BBU.0035	(160405035)	35 mm	R/L
13.0405.BBU.0040	(160405040)	40 mm	R/L

Hinterlegeschloss Typ 0429

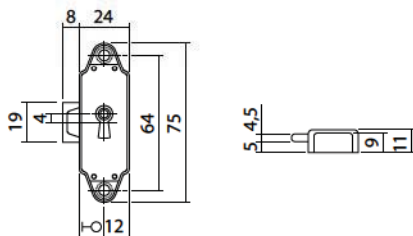

für Rahmentüren
zum Aufschrauben
Metallguss
brüniert
VPE 200



Artikelnummer	ehemals	Dornmaß	Schließrichtung
13.0429.BBR.0012	(0429.005.000.0012)	12,5 mm	R
13.0429.BBL.0012	(0429.006.000.0012)	12,5 mm	L

Hinterlegeschloss Typ 0426



zum Aufschrauben
Metallguss
vernickelt
VPE 100

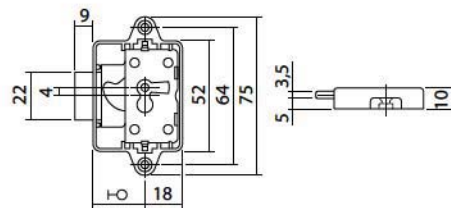

Artikelnummer	ehemals	Dornmaß	Schließrichtung
13.0426.BNR.0015	(0426.001.000.0015)	15 mm	R/lad
13.0426.BNR.0020	(0426.017.000.0020)	20 mm	R/lad
13.0426.BNR.0025	(0426.005.000.0025)	25 mm	R/lad
13.0426.BNR.0030	(0426.009.000.0030)	30 mm	R/lad
13.0426.BNL.0015	(0426.002.000.0015)	15 mm	L
13.0426.BNL.0020	(0426.018.000.0020)	20 mm	L
13.0426.BNL.0025	(0426.006.000.0025)	25 mm	L
13.0426.BNL.0030	(0426.010.000.0030)	30 mm	L

Hinterlegeschloss Typ 0426



zum Aufschrauben
Metallguss
brüniert
VPE 100

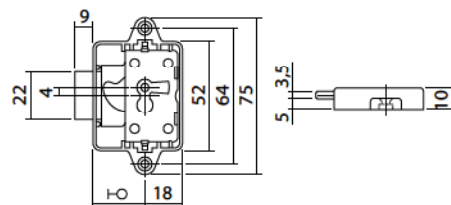

Artikelnummer	ehemals	Dornmaß	Schließrichtung
13.0426.BBR.0015	(0426.013.000.0015)	15 mm	R/lad
13.0426.BBR.0030	(0426.022.000.0030)	30 mm	R/lad
13.0426.BBL.0015	(0426.014.000.0015)	15 mm	L
13.0426.BBL.0030	(0426.023.000.0030)	30 mm	L

Kastenschloss Typ 530



zum Aufschrauben
vernickelt
VPE 100

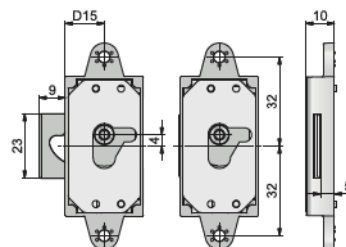

Artikelnummer	ehemals	Dornmaß	Schließrichtung
13.0530.BNR.0012	(145300121)	12 mm	R
13.0530.BNR.0015	(145300151)	15 mm	R
13.0530.BNR.0020	(145300201)	20 mm	R
13.0530.BNR.0025	(145300251)	25 mm	R
13.0530.BNR.0030	(145300301)	30 mm	R



Kastenschloss Typ 530

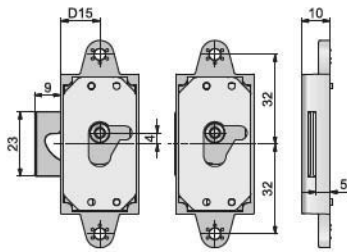

zum Aufschrauben
vernickelt
VPE 100



Artikelnummer	ehemals	Dornmaß	Schließrichtung
13.0530.BNL.0012	(145300122)	12 mm	L
13.0530.BNL.0015	(145300152)	15 mm	L
13.0530.BNL.0020	(145300202)	20 mm	L
13.0530.BNL.0025	(145300252)	25 mm	L
13.0530.BNL.0030	(145300302)	30 mm	L

Kastenschloss Typ 530

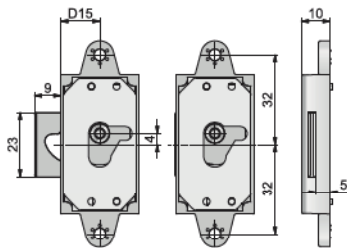

zum Aufschrauben
hellbrüniert
VPE 100



Artikelnummer	ehemals	Dornmaß	Schließrichtung
13.0530.BBR.0012	(135300121)	12 mm	R
13.0530.BBR.0015	(135300151)	15 mm	R
13.0530.BBR.0020	(135300201)	20 mm	R
13.0530.BBR.0025	(135300251)	25 mm	R
13.0530.BBR.0030	(135300301)	30 mm	R

Kastenschloss Typ 530

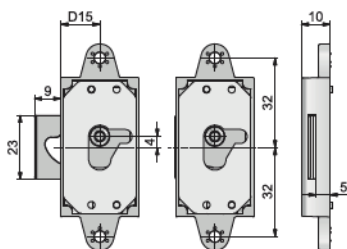

zum Aufschrauben
hellbrüniert
VPE 100



Artikelnummer	ehemals	Dornmaß	Schließrichtung
13.0530.BBL.0012	(135300122)	12 mm	L
13.0530.BBL.0015	(135300152)	15 mm	L
13.0530.BBL.0020	(135300202)	20 mm	L
13.0530.BBL.0025	(135300252)	25 mm	L
13.0530.BBL.0030	(135300302)	30 mm	L



Hinterlegschlösser

Typ 584

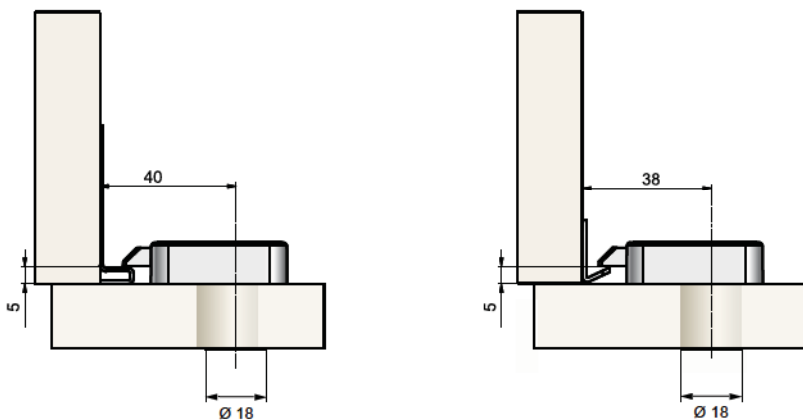

Typ 587

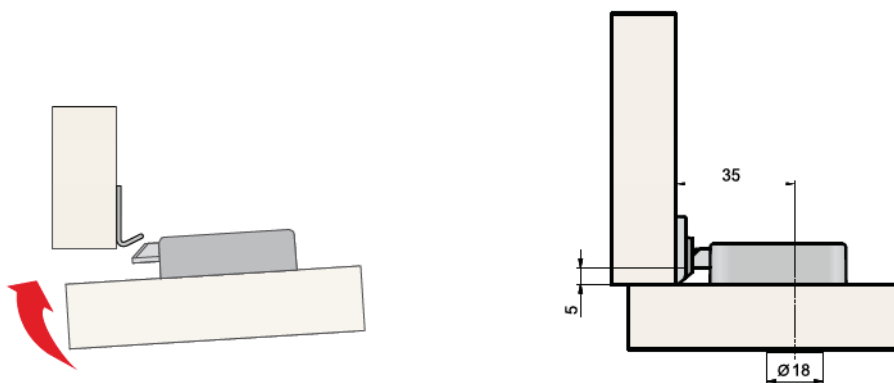

Schlossmitte

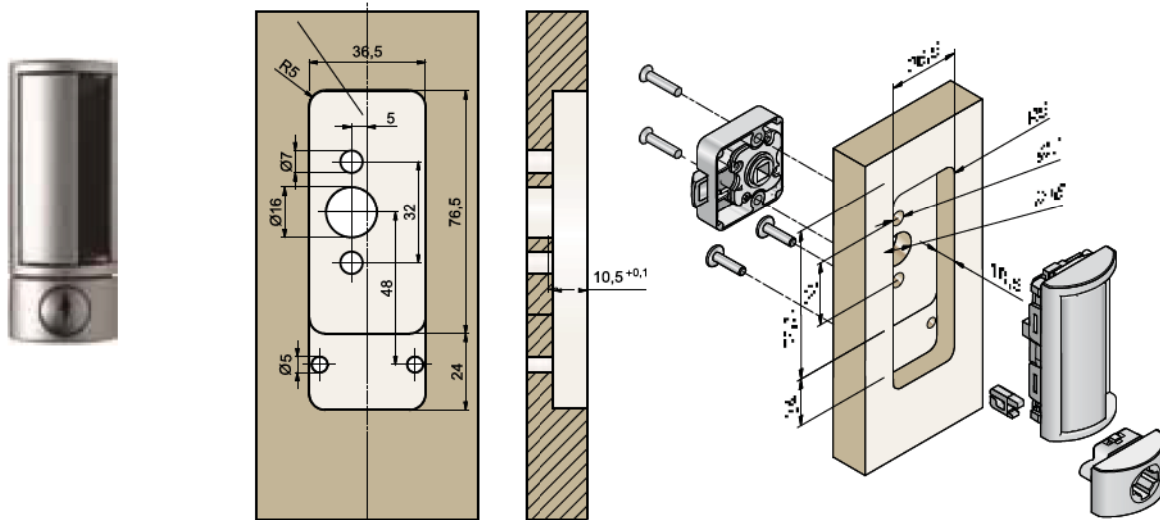



Schnäpperschloss Typ 587

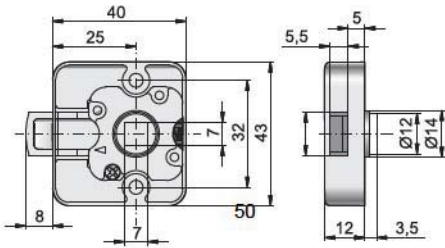

mit Vierkantaufnahme
zum Aufschrauben
vernickelt
VPE 50



Artikelnummer	ehemals	Dornmaß	Schließrichtung
13.0587.KNU.0025	(145807250)	25 mm	R/L

Insertgriff 51-32

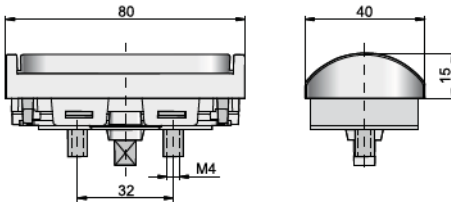

mit Vierkant
matt vernickelt
VPE 25



Artikelnummer	ehemals
13.5107.KNO.0032	(585107321)





Einsteck-, Einlass-, Klappen- und Schiebetürschlösser

Inhalt

- Einsteckschlösser
- Einlassschlösser
- Klappenschlösser
- Schiebetürschlösser

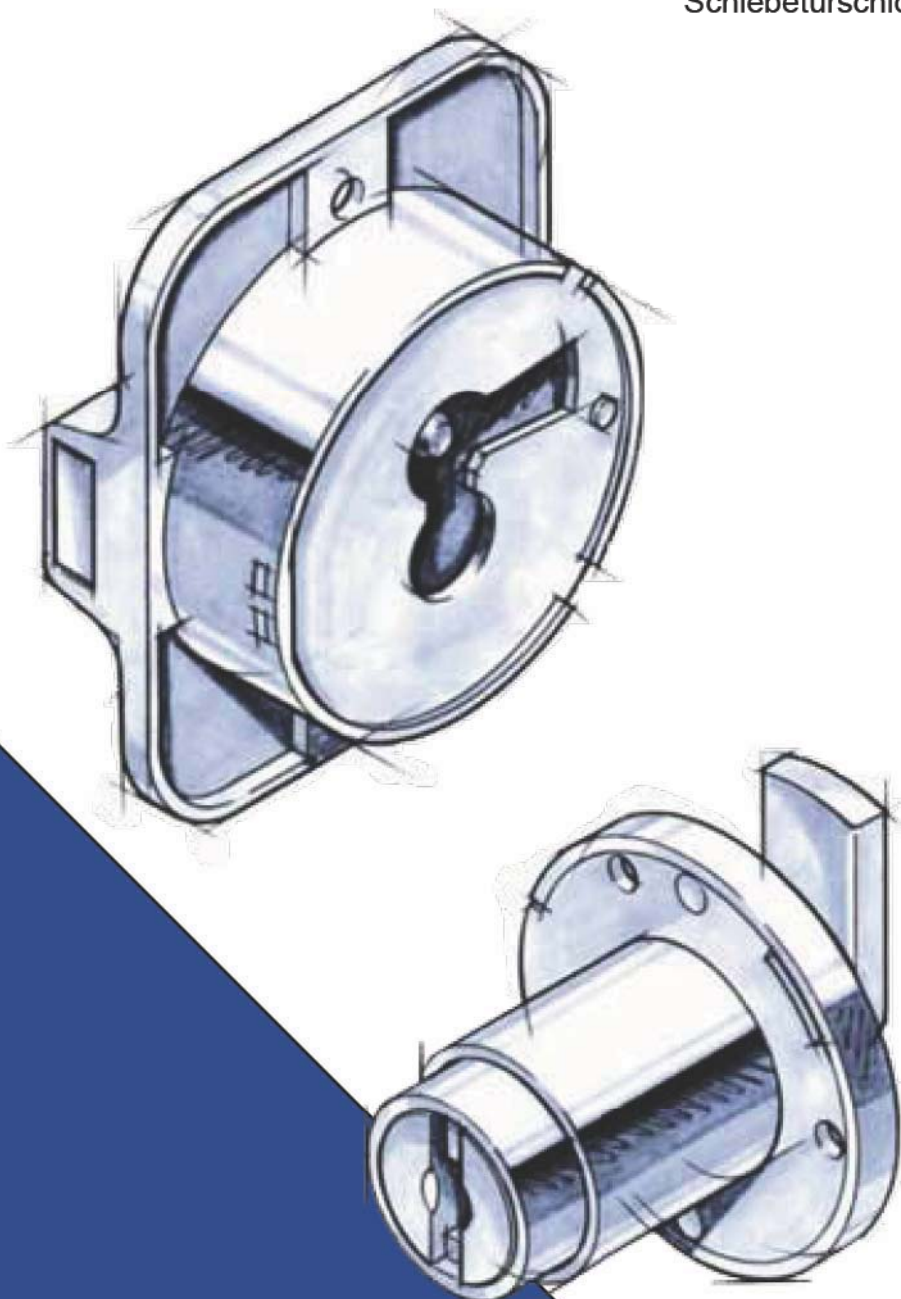

Typ 490

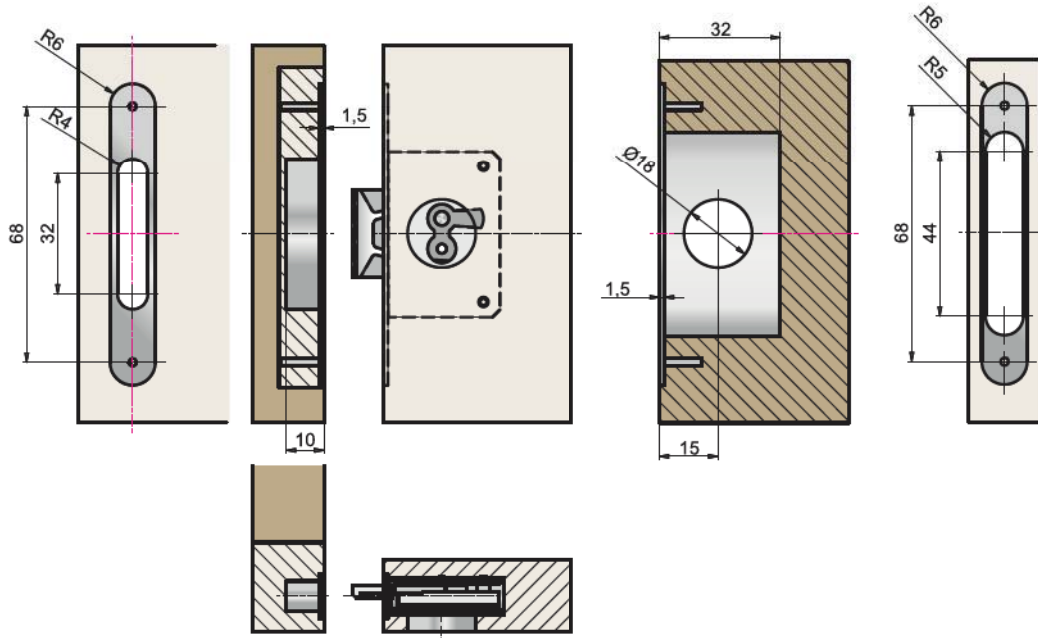

Einsteckschloss Typ 490



Stulpe vermessingt, 80 x 12 mm
zum Einstecken
vermessingt
VPE 100

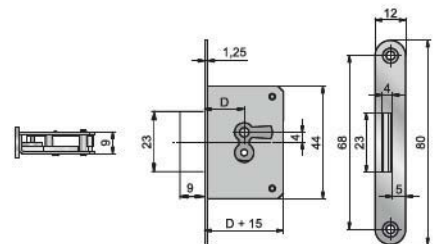

Artikelnummer	ehemals	Dornmaß	Schließrichtung
14.0490.BMR.0015	(124900151)	15 mm	R
14.0490.BMR.0020	(124900201)	20 mm	R
14.0490.BMR.0025	(124900251)	25 mm	R
14.0490.BMR.0030	(124900301)	30 mm	R
14.0490.BMR.0035	(124900351)	35 mm	R
14.0490.BMR.0040	(124900401)	40 mm	R



Einsteckschloss Typ 490

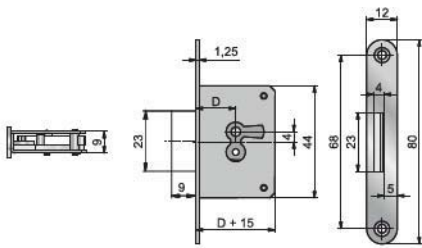

Stulpe vermessingt, 80 x 12 mm
zum Einstecken
vermessingt
VPE 100



Artikelnummer	ehemals	Dornmaß	Schließrichtung
14.0490.BML.0015	(124900152)	15 mm	L
14.0490.BML.0020	(124900202)	20 mm	L
14.0490.BML.0025	(124900252)	25 mm	L
14.0490.BML.0030	(124900302)	30 mm	L
14.0490.BML.0035	(124900352)	35 mm	L
14.0490.BML.0040	(124900402)	40 mm	L

Schließblech 8012

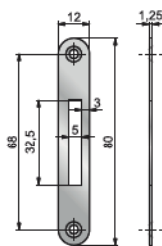

für Schloss Typ 490
vermessingt
VPE 100



Artikelnummer	ehemals
14.0490.ZMO.8012	(458012200)

Einlassschloss Typ 0355

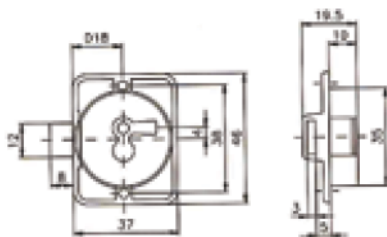

zum Aufschrauben
Metallguss
brüniert
VPE 100



Artikelnummer	ehemals	Dornmaß	Schließrichtung
14.0355.BBR.0181	(133500181)	19 mm	R
14.0355.BBL.0182	(133500182)	19 mm	L
14.0355.BBD.0183	(133500183)	19 mm	lad

Typ 393

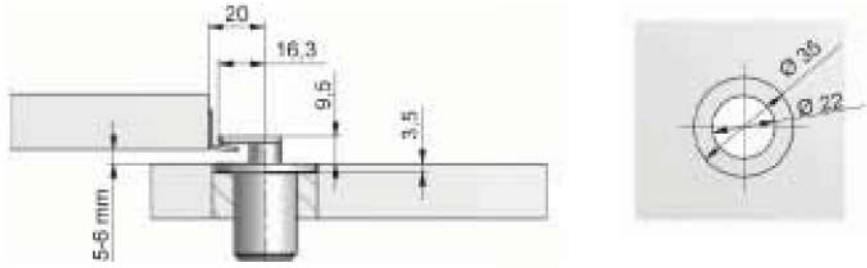

Typ 792

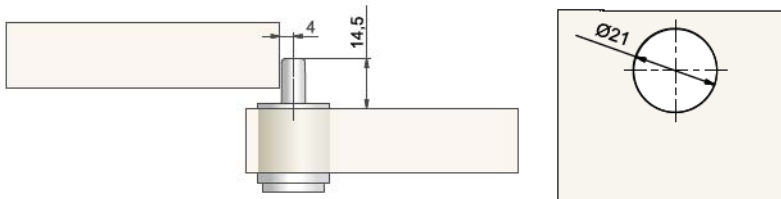

Typ 501

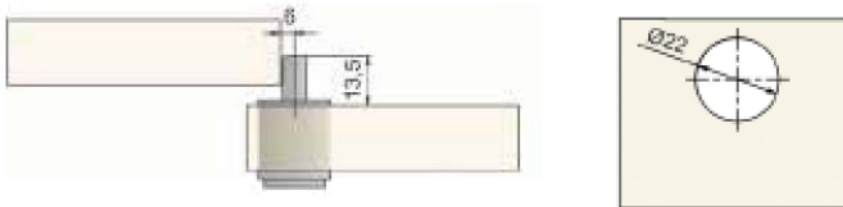

Typ 514

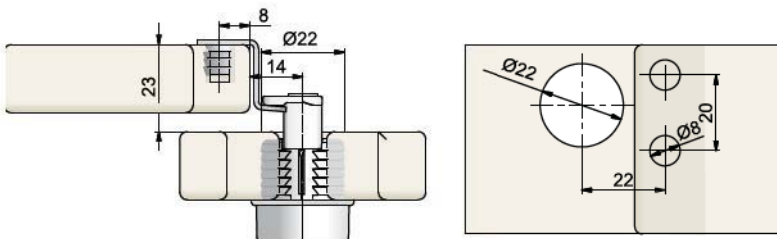

Typ 515

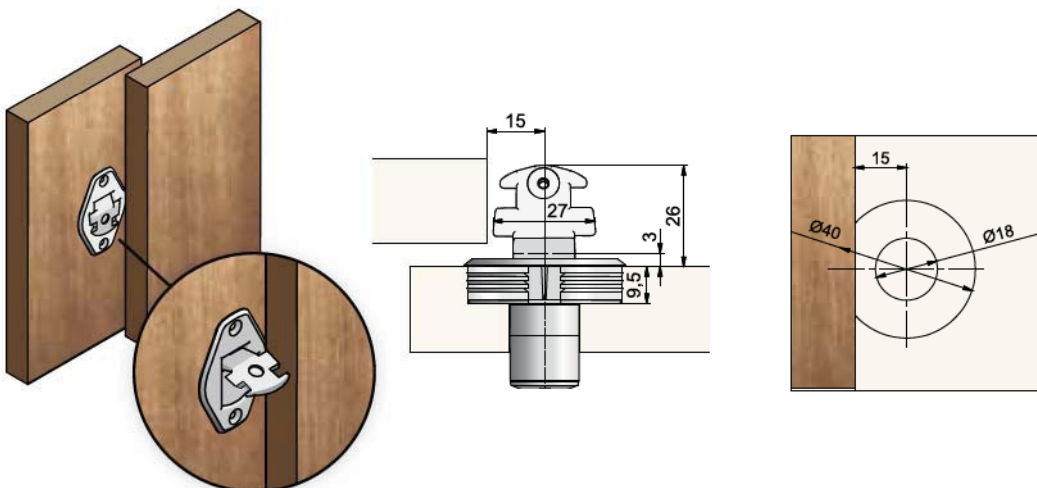



Klappen-, Schiebetürschloss Typ 0393 VCS18.2

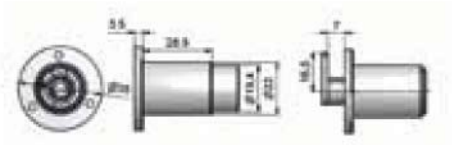

für Wechselzylinder VCS18
mit Druck-Drehriegel
Ø 22 mm
zum Aufschrauben
Metallguss
matt vernickelt
VPE 100



Artikelnummer	ehemals	Schließrichtung	Hub	Schließweg	Schließzwang
14.0393.VND.5042	(0393.504.001)	lad	2,5 mm	90°	mit
14.0393.VND.5235	(0393.523.001)	lad	5 mm	180°	ohne
14.0393.VND.5007	(0393.500.001)	lad	7 mm	90°	mit
14.0393.VND.5227	(0393.522.001)	lad	7 mm	180°	ohne
14.0393.VND.5257	(0393.525.001)	lad	7 mm	90°	ohne

Schiebetürverschluss STV rund Typ 0394 VCS18.2

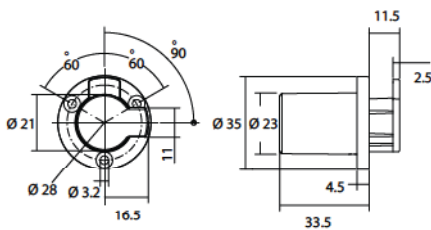

für Wechselzylinder VCS18
mit Riegel 16,5 mm
Ø 23 mm
zum Einlassen und Aufschrauben
Metallguss
vernickelt
VPE 25



Artikelnummer	ehemals
14.0394.VNO.0501	(0394.501.001)

Schiebetürverschluss STV rund Typ 0394 VCS18.2

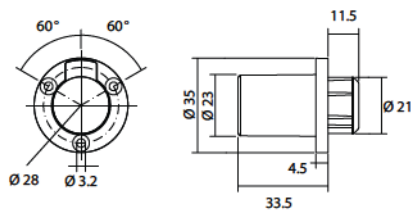

für Wechselzylinder VCS18
mit rundem Riegel 21 mm
Ø 23 mm
zum Einlassen und Aufschrauben
Metallguss / vernickelt
VPE 25



Artikelnummer	ehemals
14.0394.VNO.0502	(0394.502.001)

Schiebetürschloss Typ 0792 VCS18.2



für Wechselzylinder VCS18
 Ø 22 mm
 zum Aufschrauben
 Metallguss
 vernickelt
 VPE 100

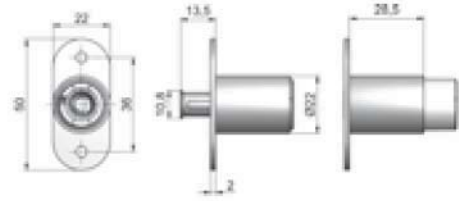

Artikelnummer	ehemals	Riegel
14.0792.VNO.0501	(0792.501.001)	mit Stift ohne Gewinde
14.0792.VNO.0601	(0792.601.001)	mit M6 Gewinde

Schiebetür-Druckzylinderschloss Typ 501 P2 mit Eindrücksicherung



für Zylinder Z23
 Bohrung 21 mm
 zum Aufschrauben
 vernickelt
 VPE 50

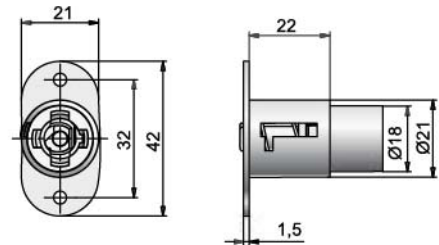

Artikelnummer	ehemals	Schließrichtung
14.0501.PNO.2005	(145012005)	R

Druckzylinderschloss Typ 521 P2



für Zylinder Z23
 zum Aufschrauben
 vernickelt
 VPE 50

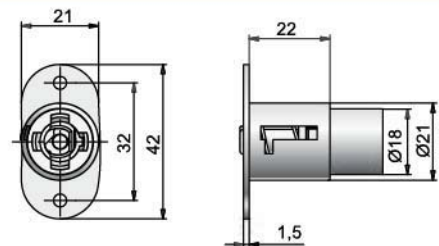

Artikelnummer	ehemals	Schließrichtung
14.0521.PNO.2005	(145212005)	R



Rosette für Typ 521

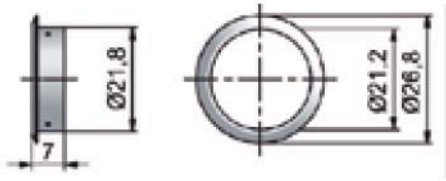

Ø 22 mm
vernickelt
VPE 500



Artikelnummer	ehemals
14.0521.ZNO.0022	(442200400)

Typ 793.01

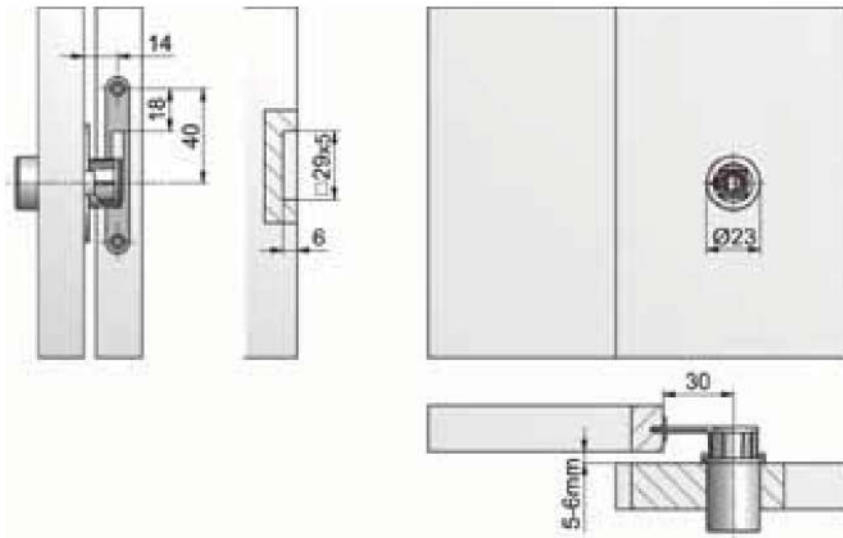

Typ 793.02

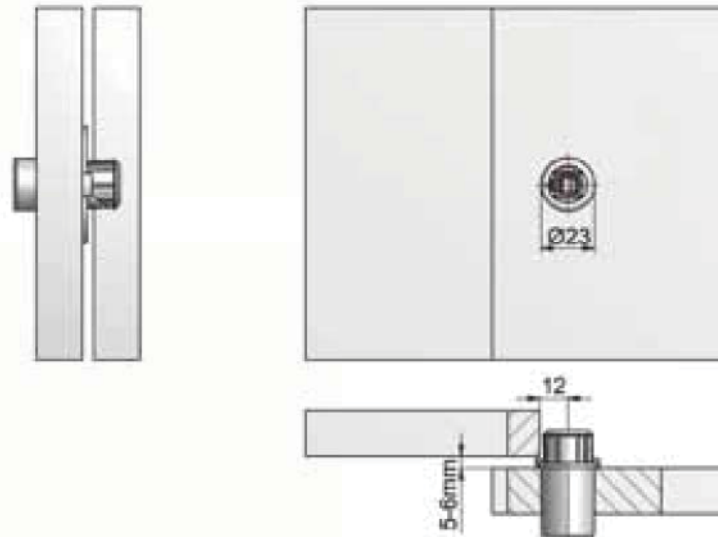

Typ 793.03

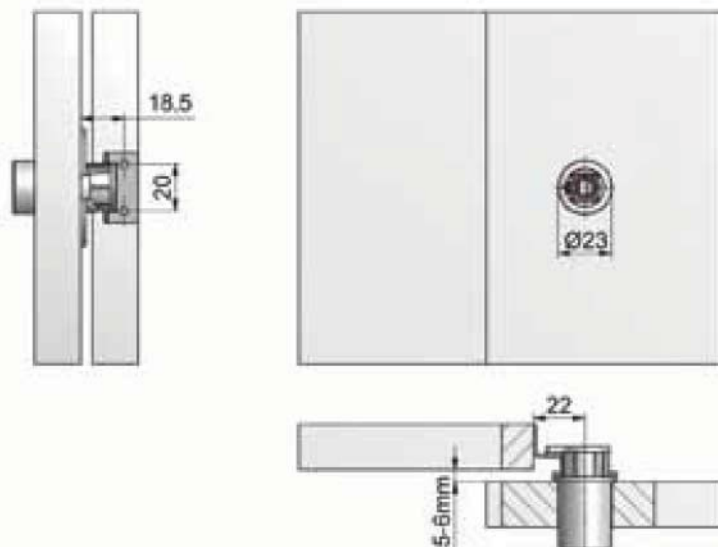



Schiebetürverschluss STV oval Typ 0793 VCS18.2

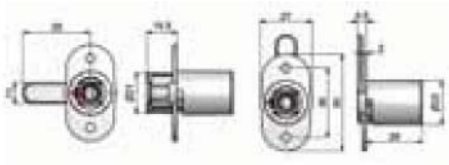

für Wechselzylinder VCS18
mit Riegel 35 mm
Ø 23 mm
zum Aufschrauben
Metallguss
vernickelt
VPE 25



Artikelnummer ehemals
14.0793.VNO.0501 (0793.501.001)

Schiebetürverschluss STV oval Typ 0793 VCS18.2

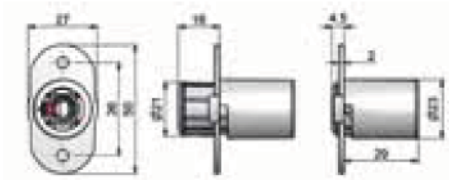

für Wechselzylinder VCS18
mit rundem Riegel 21 mm
Ø 23 mm
zum Aufschrauben
Metallguss
vernickelt
VPE 25



Artikelnummer ehemals
14.0793.VNO.0502 (0793.502.001)

Schiebetürverschluss STV oval Typ 0793 VCS18.2

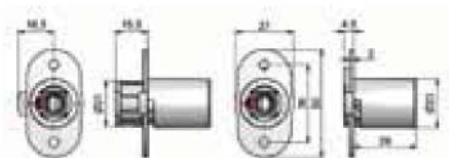

für Wechselzylinder VCS18
mit Riegel 16,5 mm
Ø 23 mm
zum Aufschrauben
Metallguss
vernickelt
VPE 25



Artikelnummer ehemals
14.0793.VNO.0503 (0793.503.001)

Klemmrosette Typ 1288 für STV Typ 0793

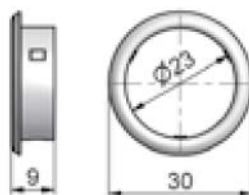

Bohrung 24 mm
Stahl
vernickelt
VPE 500



Artikelnummer ehemals
14.1288.ZNO.0001 (1288.001.000)

Schiebetür-Dreh-Druckzylinderschloss Typ 514 P2



für Zylinder Z23
Bohrung 22 mm
zum Einpressen
vernickelt
VPE 25

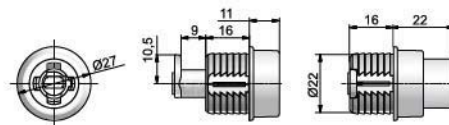

Artikelnummer	ehemals	Schließrichtung
14.0514.PNO.2005	(145142005)	R

Anschlagwinkel 3014.1 für Typ 514



vernickelt
VPE 100

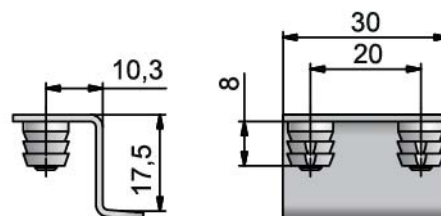

Artikelnummer	ehemals
14.0514.ZNO.3014	(443014101)

Stahlschiebetürschloss Typ 0796 VCS18.2 mit Riegel



für Wechselzylinder VCS18
mit Gewinde und Mutter
Metallguss
matt vernickelt
VPE 25

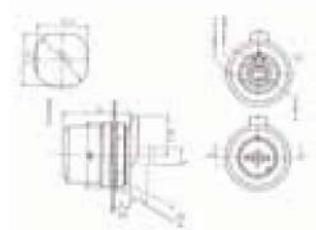

Artikelnummer	ehemals
14.0796.VNO.0551	(0796.551.001)



Stahlschiebetürschloss Typ 0797 VCS18.2 (Druckzyl.)



für Wechselzylinder VCS18
mit Außengewinde
M24x1,5 Gewindesteigung
mit Drehriegel 31 mm
Sechskantmutter
matt vernickelt
VPE 50



Artikelnummer	ehemals
14.0797.VNO.0531	(0797.531.001)

Schiebetürschloss Typ 515 P2

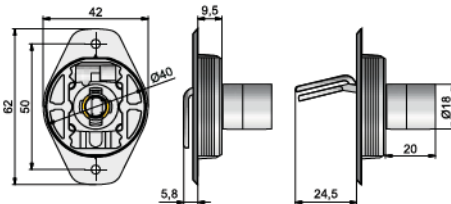

für Zylinder Z23
Bohrung 40 mm
vernickelt
VPE 50



Artikelnummer	ehemals	Schließrichtung
14.0515.PNO.2005	(145152005)	R

Schiebetürschloss Typ 515 VCS18.2

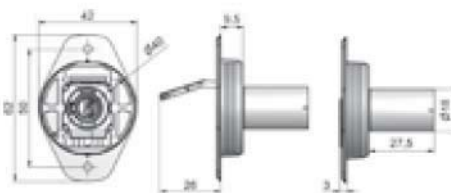

für Wechselzylinder VCS18
Bohrung 40 mm
vernickelt
VPE 50



Artikelnummer	ehemals	Schließrichtung
14.0515.VNO.7001	(1451567001)	R



Spezialschlösser

Inhalt

Hebelriegelschlösser
Rolljalousieschlösser
Stahlschlösser
Zahlenkombinationsschlösser

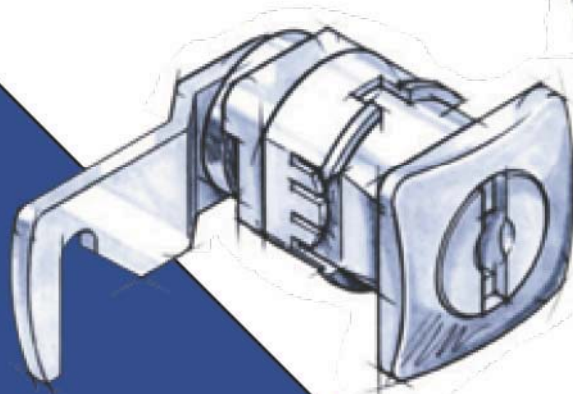
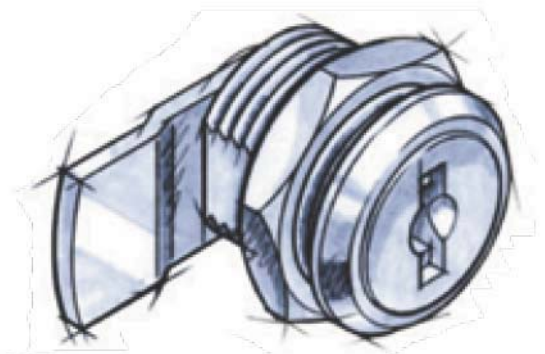
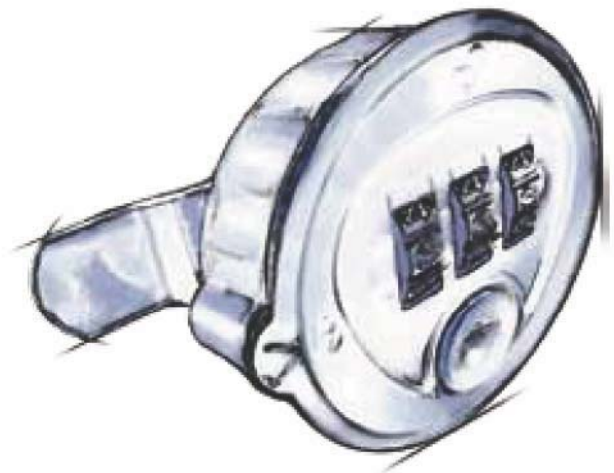
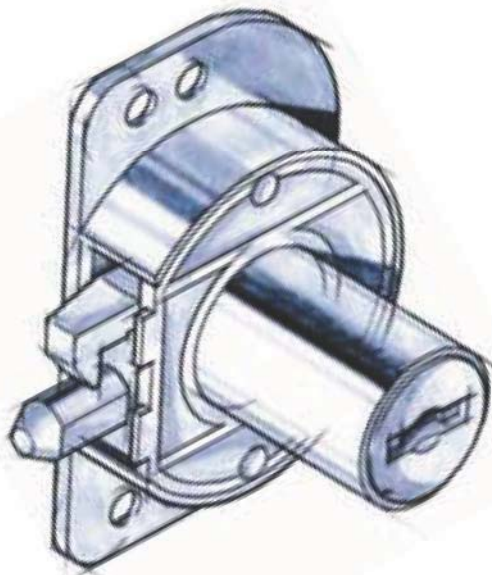

Typ 827

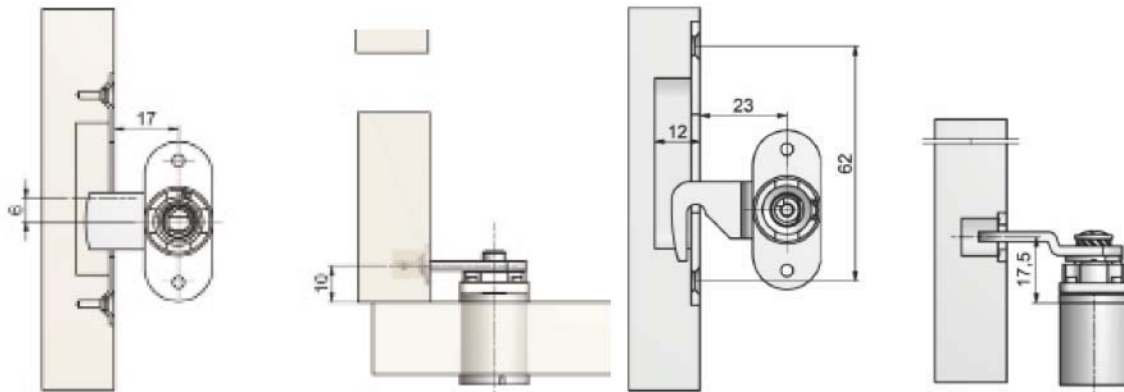

Typ 371

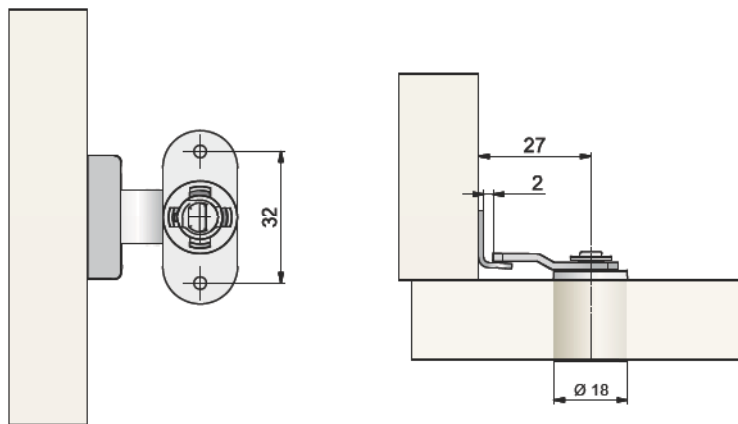

Typ 375

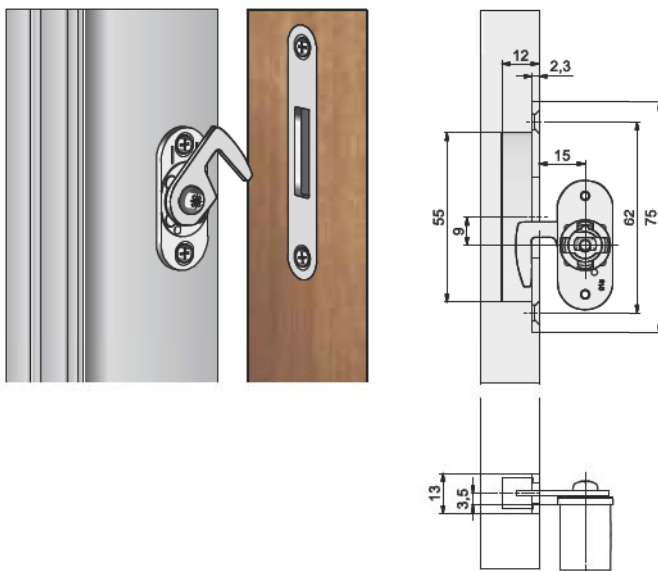

Hebelriegelschloss Typ 0827 VCS18.2

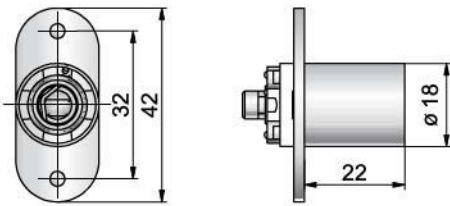

für Wechselzylinder VCS18
ohne Riegel
zum Aufschrauben
matt vernickelt
VPE 100



Artikelnummer	ehemals
15.0827.VNO.0601	(0827.601.001)

Hebelriegelschloss Typ 0829, mit Außengewinde M19x1, ohne Riegel

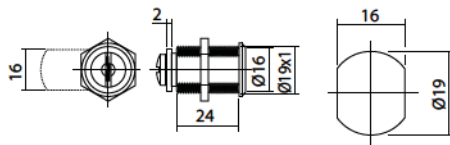

mit Zylinder 16,5 mm
Materialstärke bis 20 mm
Metallguss
vernickelt
VPE 100



Artikelnummer	ehemals
15.0829.FNO.0123	(0829.101.123)
15.0829.FNO.0555	(0829.101.555)

Hebelriegelschloss Typ 0868

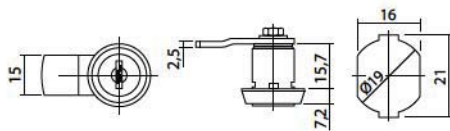

mit Zylinder VCS18
nicht wechselbar
Riegel gekröpft
Materialstärke bis 1 mm
Stahl
vernickelt
VPE 100



Artikelnummer	ehemals	Schließweg
15.0868.VNO.3423	(0868.534.123)	180°

Hebelriegelschloss Typ 0869 VCS18.2

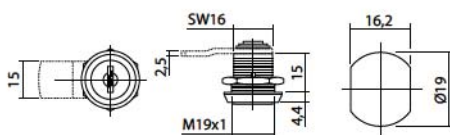

für Wechselzylinder VCS18
für Stahlmöbel und Glas
ohne Riegel
Materialstärke bis 11 mm
Metallguss
vernickelt
VPE 100



Artikelnummer	ehemals	Schließrichtung	Hub	Schließweg
17.0869.VNU.0000	(0869.544.000)	R/L	Hub 12 mm	180°

Anschraub-Arretierungsplatte für Typ 0829/868



Sichert das Schloss bei Holzkonstruktionen gegen Verdrehen.
Stahl
vernickelt
VPE 100

1 dick

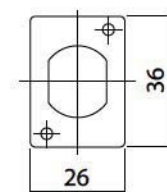

Artikelnummer ehemals
15.0829.ZNO.2001 (0829.002.001)

Mutterbefestigung für Typ 0829 und 0869

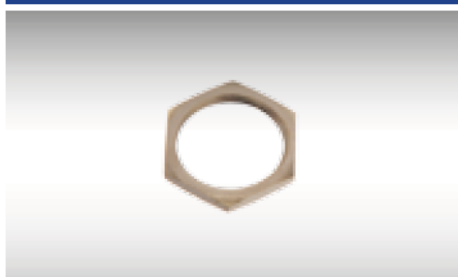

Materialstärke bis 11 mm
Stahl
vernickelt
VPE 100

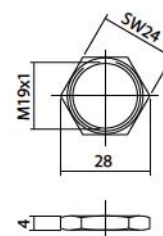

Artikelnummer ehemals
15.0829.ZNO.0003 (0829.003.001)

Gabelfeder für Typ 0829 und 0869



Materialstärke 0,8-1,2 mm
Stahl
verzinkt
VPE 100

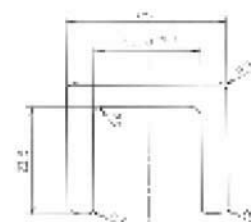

Artikelnummer ehemals
15.0829.ZZO.0004 (0829.004.001)

Gabelfeder für Typ 0868



Stahl
verzinkt
VPE 100



Artikelnummer ehemals
15.0868.ZZO.1021 (0868.102.001)

Hebelzylinderschloss Typ 375 P2

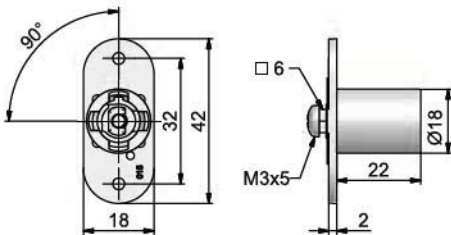

für Zylinder Z23
Durchmesser 18 mm
zum Anschrauben
vernickelt
VPE 50



Artikelnummer	ehemals	Schließrichtung
15.0375.PNR.4025	(143754025)	R
15.0375.PNL.4025	(143764025)	L

Riegel für Typ 0827/0829/0873

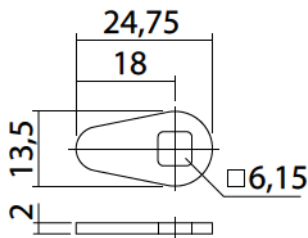

gerade
18 mm ab Lochmitte
Stahl
vernickelt
VPE 100



Artikelnummer	ehemals	Gesamtlänge
15.0827.ZNG.0025	(0827.002.001)	25 mm

Riegel für Typ 0827/0829/0873 mit Ausklinkung

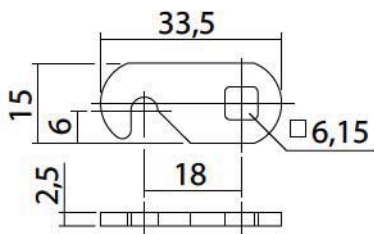

gerade
26,5 mm ab Lochmitte
Stahl
vernickelt
VPE 100



Artikelnummer	ehemals	Gesamtlänge
15.0827.ZNG.0033	(0827.002.003)	33,5 mm

Riegel für Typ 0827/0829/0873

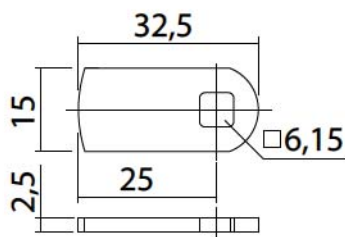

gerade
25 mm ab Lochmitte
Stahl
vernickelt
VPE 100



Artikelnummer	ehemals	Gesamtlänge
15.0827.ZNG.0032	(0827.002.005)	32 mm

Riegel für Typ 0827/0829/0873



gerade
30 mm ab Lochmitte
Stahl
vernickelt
VPE 100

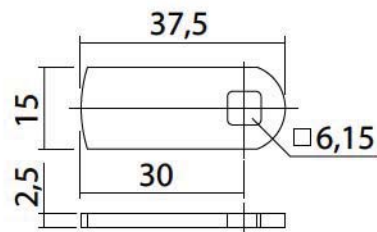

Artikelnummer	ehemals	Gesamtlänge
15.0827.ZNG.0037	(0827.002.007)	37 mm

Riegel für Typ 0827/0829/0873



gerade
45 mm ab Lochmitte
Stahl
vernickelt
VPE 100

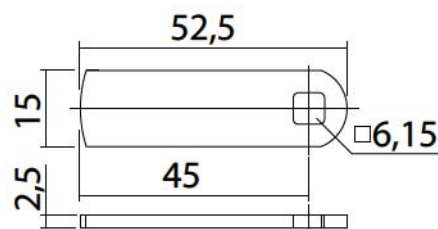

Artikelnummer	ehemals	Gesamtlänge
15.0827.ZNG.0052	(0827.002.016)	52 mm

Riegel für Typ 0827/0829/0873



Kröpfung 1,4 mm
26 mm ab Lochmitte
Stahl
vernickelt
VPE 100

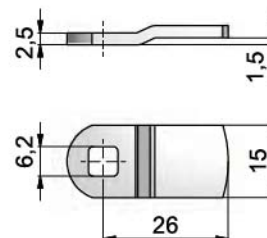

Artikelnummer	ehemals	Gesamtlänge
15.0827.ZNK.0033	(0827.002.017)	33 mm

Riegel für Typ 0827/0829/0873



gerade
44 mm ab Lochmitte
Stahl
vernickelt
VPE 100

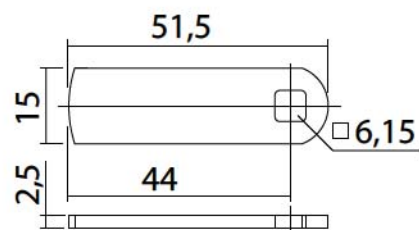

Artikelnummer	ehemals	Gesamtlänge
15.0827.ZNG.0051	(0827.002.021)	51,5 mm

Riegel für Typ 0827/0829/0873

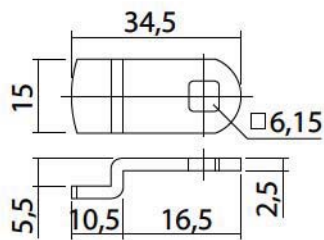

Kröpfung 5,5 mm
27,5 mm ab Lochmitte
Stahl
vernickelt
VPE 100

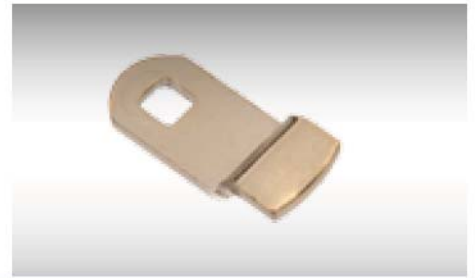

Artikelnummer	ehemals	Gesamtlänge
15.0827.ZNK.0034	(0827.002.022)	34,5 mm

Riegel für Typ 0827/0829/0873 mit Ausklung

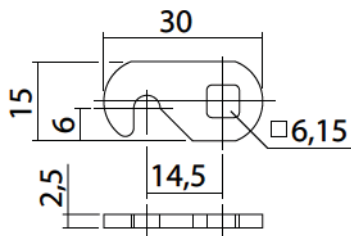

gerade
23 mm ab Lochmitte
Stahl
vernickelt
VPE 100



Artikelnummer	ehemals	Gesamtlänge
15.0827.ZNG.2052	(0827.002.052)	30 mm

Riegel für Typ 0827/0829/0873

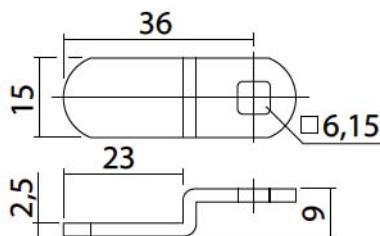

Kröpfung 6,4 mm
36 mm ab Lochmitte
Stahl
vernickelt
VPE 100



Artikelnummer	ehemals	Gesamtlänge
15.0827.ZNK.0043	(0827.002.074)	43 mm

Riegel für Typ 0827/0829/0873 mit Ausklung

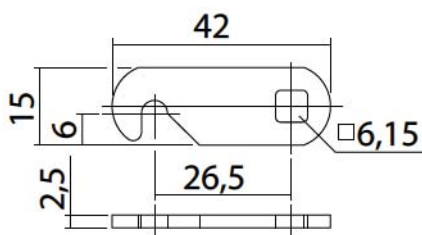

gerade
35 mm ab Lochmitte
Stahl
vernickelt
VPE 100



Artikelnummer	ehemals	Gesamtlänge
15.0827.ZNG.0042	(0827.002.075)	42 mm

Riegel für Typ 0827/0829/0873 mit Ausklingung



gerade
29 mm ab Lochmitte
Stahl
vernickelt
VPE 100

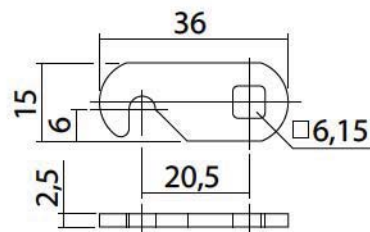

Artikelnummer	ehemals	Gesamtlänge
15.0827.ZNG.0036	(0827.002.091)	36 mm

Riegel 023



23,5 mm ab Lochmitte
vernickelt
VPE 100

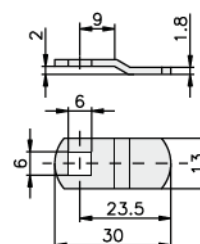

Artikelnummer	ehemals	Gesamtlänge
15.0371.ZNK.0030	(443710230)	30 mm

Riegel 161



39,5 mm ab Lochmitte
vernickelt
VPE 100

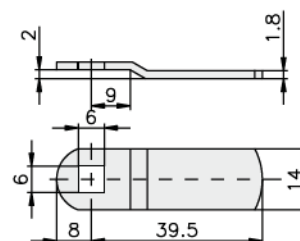

Artikelnummer	ehemals	Gesamtlänge
15.0371.ZNK.0047	(443711610)	47,5 mm

Riegel 166



34 mm ab Lochmitte
vernickelt
VPE 100

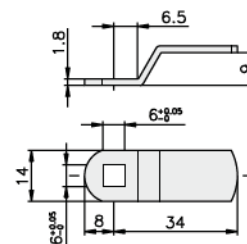

Artikelnummer	ehemals	Gesamtlänge
15.0371.ZNK.0042	(443711660)	42 mm