



Galjour CHANDELIER

INSTALLATION GUIDE



WEARING GLOVES
IS RECOMMENDED

DANGER: ELECTRIC SHOCK RISK. FOR YOUR SAFETY,
TURN OFF ELECTRICAL POWER BEFORE BEGINNING
INSTALLATION AND USE CAUTION WHEN INSTALLING.

+1 888.399.9905

www.vault-light.com | sales@vault-light.com



ASSEMBLY & INSTALLATION INSTRUCTIONS

Please read carefully and save these instructions, as you may need them at a later date.

CAUTION

Turn off the main power at the circuit breaker before installing the fixture, in order to prevent possible shock.

GENERAL

All electrical connections must be in accordance with local and national electrical code (N.E.C) standards. If you are unfamiliar with proper electrical wiring connections obtain the services of a qualified electrician.

Remove the fixture and the mounting package from the box and make sure that no parts are missing by referencing the illustrations on the installation instruction.

ASSEMBLY AND INSTRUCTION

1. Please make sure power off before mounting whole fixture;
2. Using 8-32" screw (3) mount plate (2) to J-Box (by others);
3. Using ½-13" nut (4) fix plate (2) on the ½-13" all thread (1) (by others);
4. Install stem (8) and stem (16) on the pendant;
5. Make sure electrical connections from J-Box and the frame;
6. Using M6 screw (5) to mount canopy (6) to plate (2), then cover the avons (7);
7. Install G9 bulb (14) on the socket (13) and then install G9 glass cover (15) (G9 bulb & G9 glass cover are not included)
8. Identify glass (12) by glass size, and then install glass by glass layout drawing. the glass will be secured with avons (10) & washer (11) provided on the branch (9).
9. Install acrylic (17) on the stem (b) (16) and then secured acrylic by metal panel (18) & metal ball (19).
10. Turn on the power after installation and debugging.

- | | | |
|-------------------------|-----------------|-----------------|
| 1. the ½-13" all thread | 9. Branch | 17. Acrylic |
| 2. plate | 10. Avons | 18. Metal panel |
| 3. 8-32" screw | 11. Washer | 19. Metal ball |
| 4. ½-13" nut | 12. Glass | |
| 5. M6 screw | 13. Socket | |
| 6. canopy | 14. G9 bulb | |
| 7. the avons | 15. Glass cover | |
| 8. Stem (a) | 16. Stem (b) | |

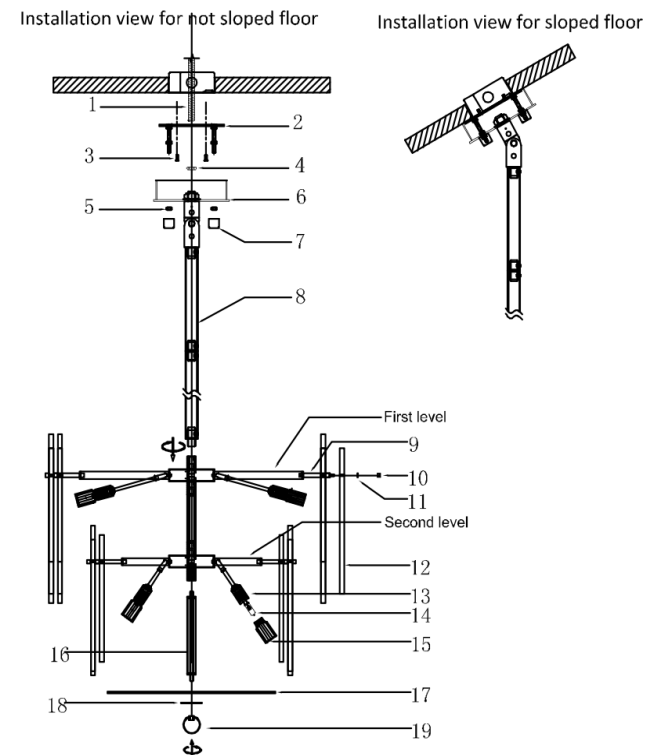

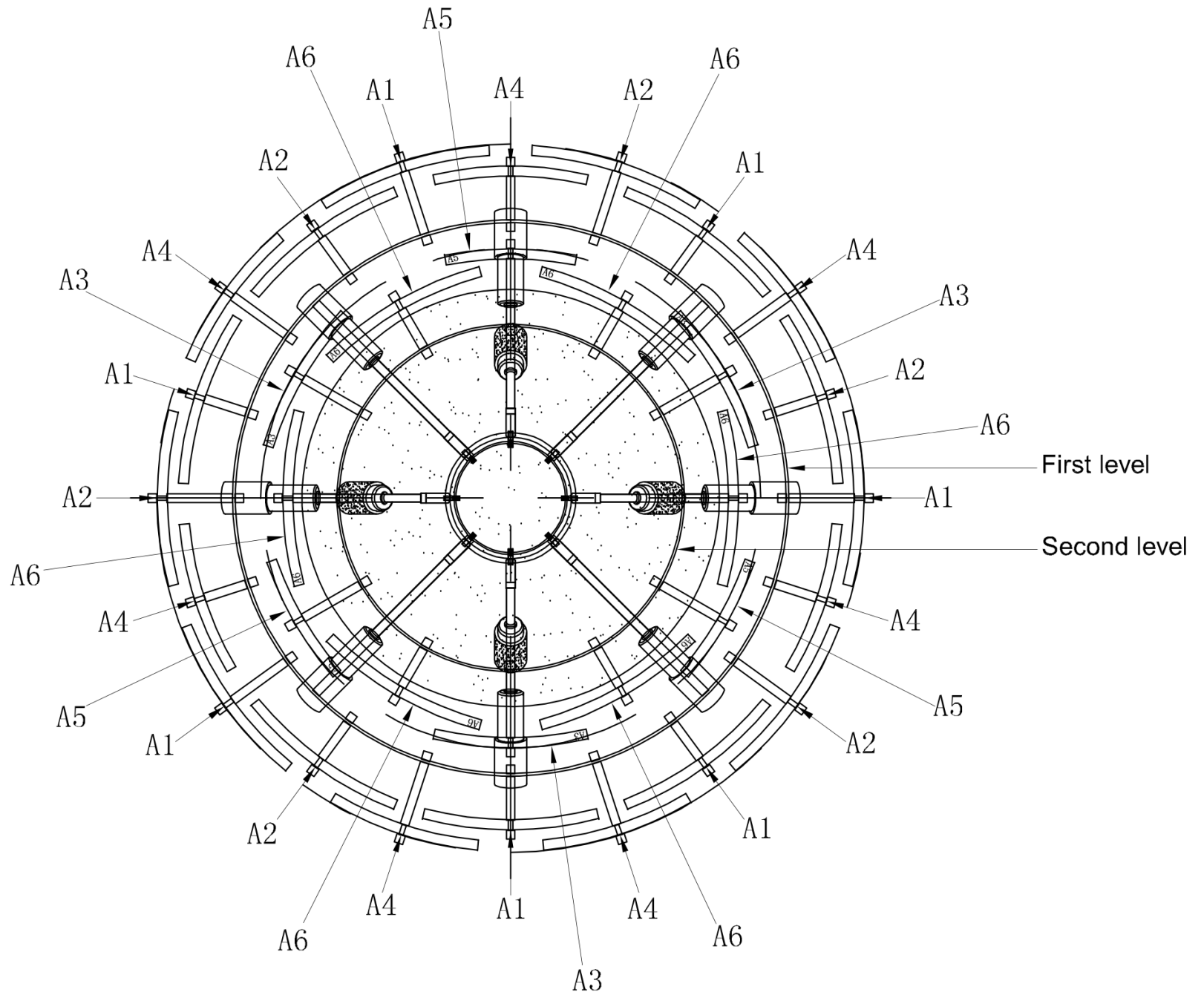

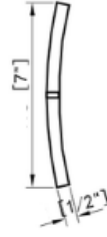
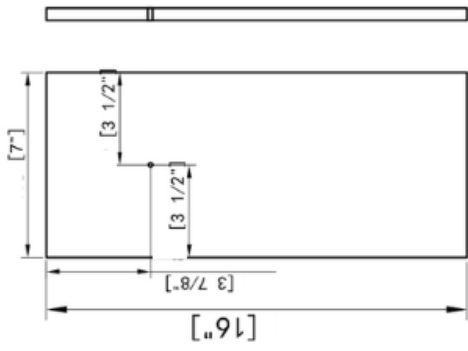

A3 3PCS

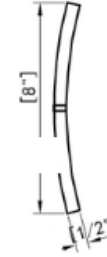
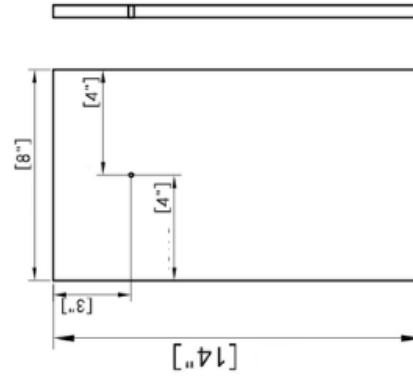

A6 6PCS

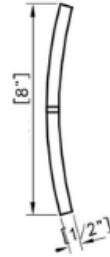
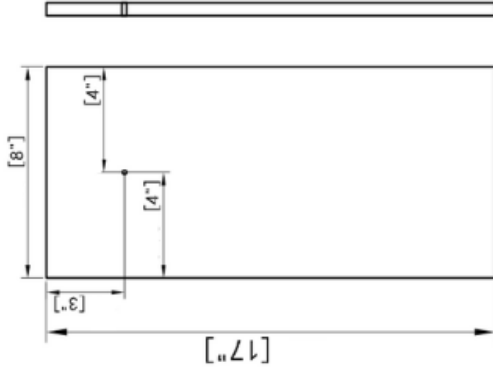

A2 6PCS

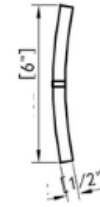
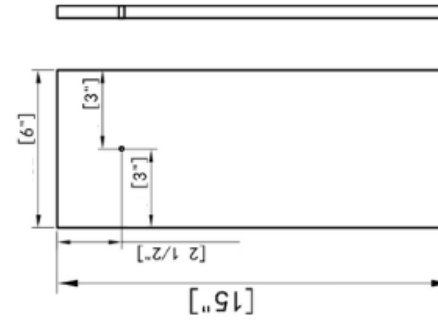

A5 3PCS

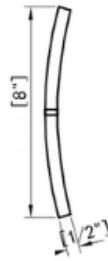
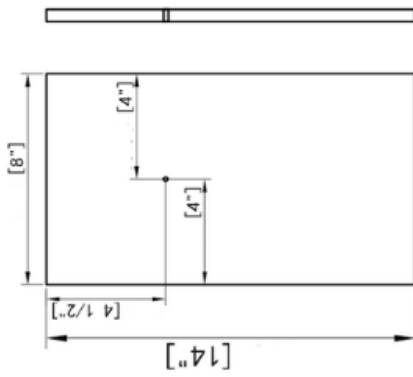

A1 7PCS

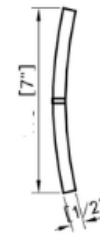
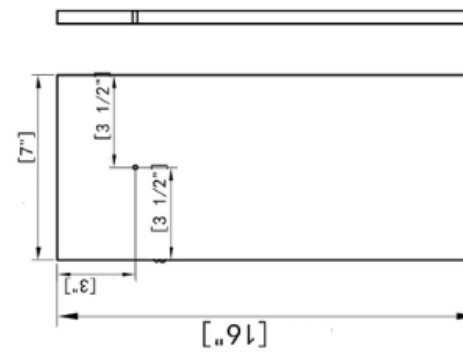

A4 7PCS