



Ventura Roof Tents

> Instructions

Ventura 2.5m Side Awning

Ventura 270 Degree Fox-wing Awning

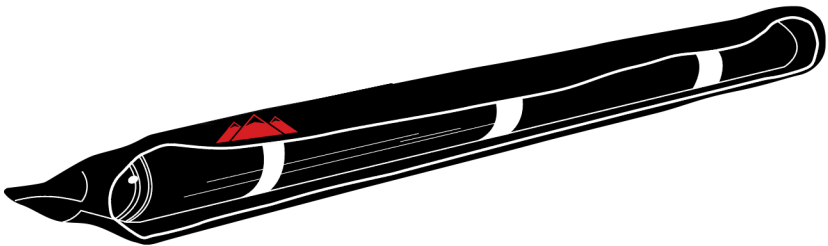

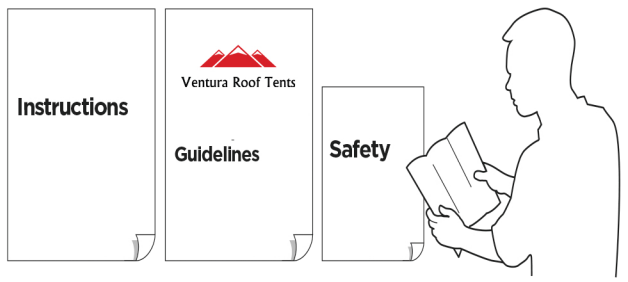

13 mm

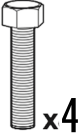

13 mm



13 mm



13 mm

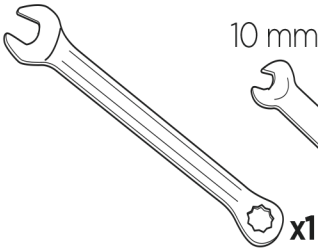

10 mm

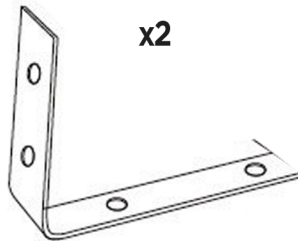
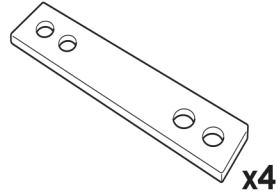
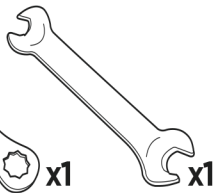

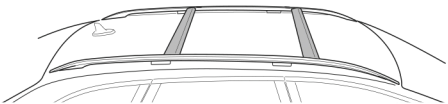
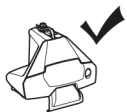
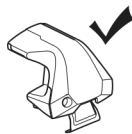
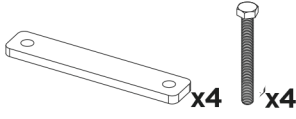
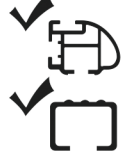
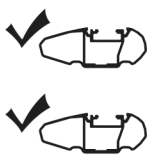
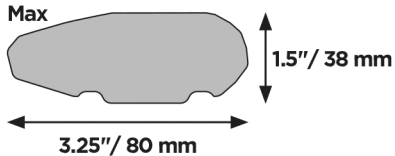

DO NOT use tents on factory installed crossbars.

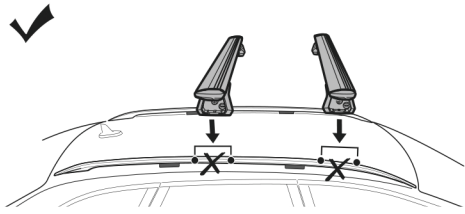
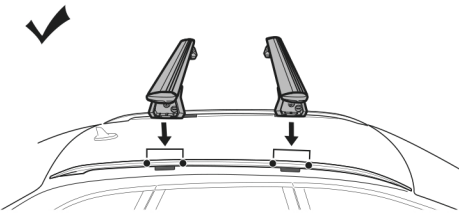
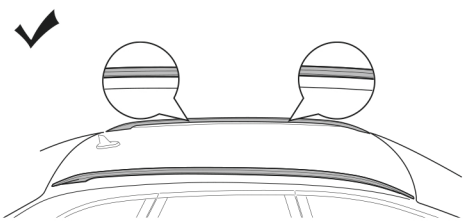
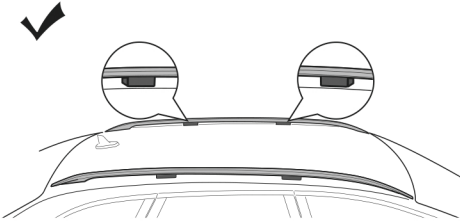
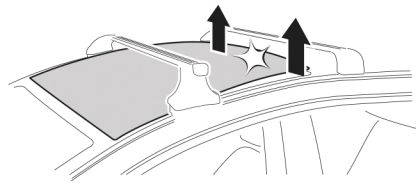

There are 2 ways you can attach the L bracket on to your roof bars



1

Clamp L bracket on via 2 steel plates that are provided

Drill through your roof bars and directly bolt L bracket through

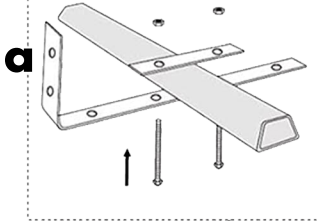

or

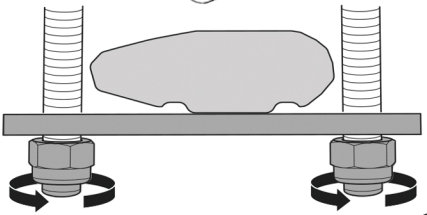
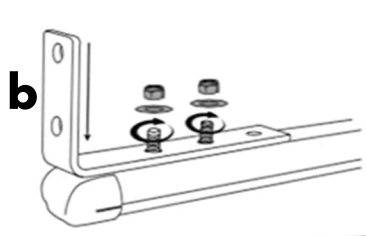

2

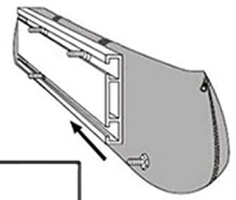
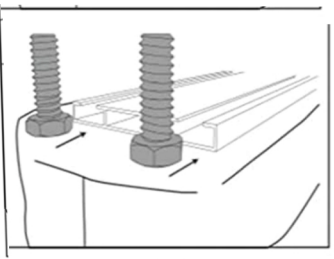

3

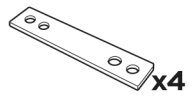
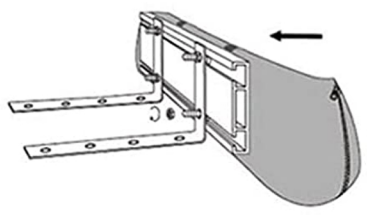
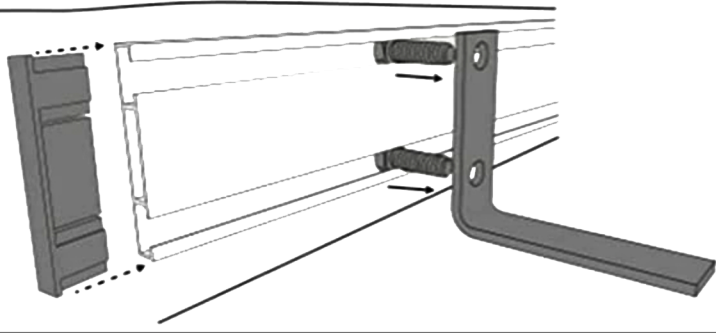

x2

x8

x4



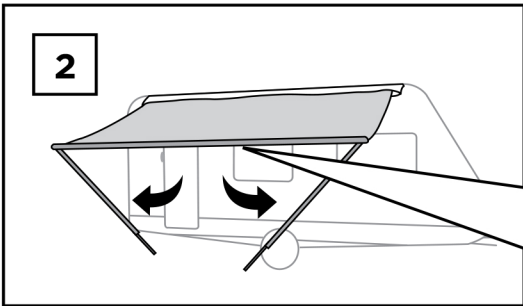
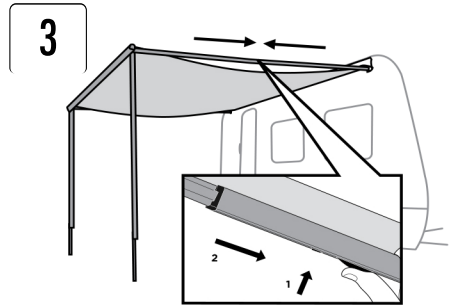
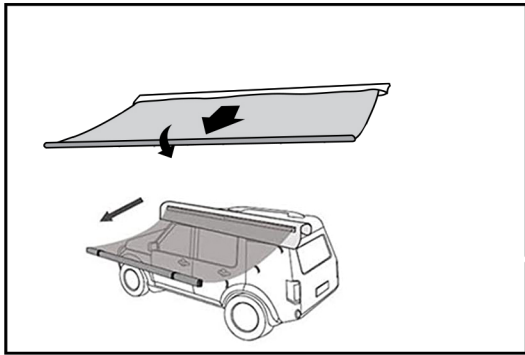
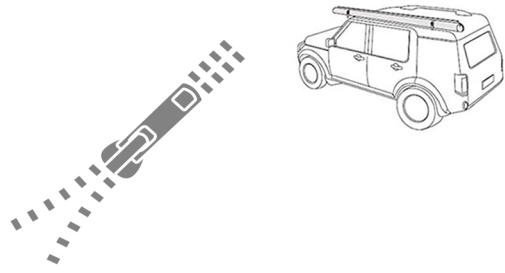
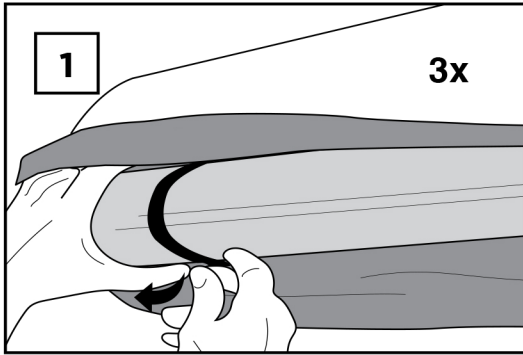

**TELESCOPIC LEGS DROP DOWN,
TWIST AND LOCK.**



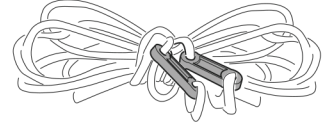
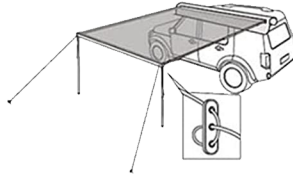
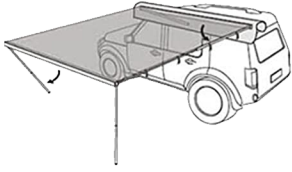

2.5m x2
270 x4

➤ Ventura 270 Degree Fox-wing Awning

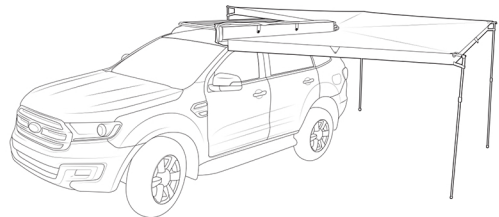
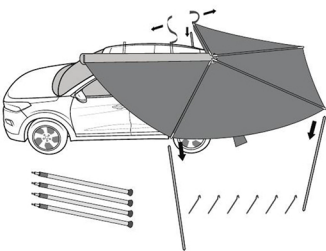
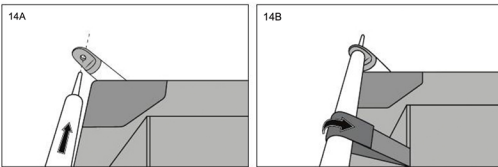
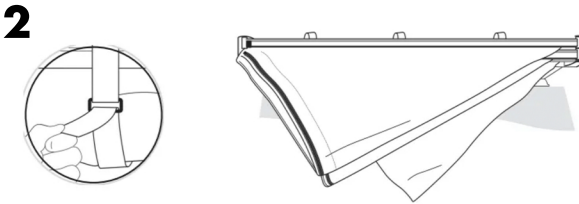
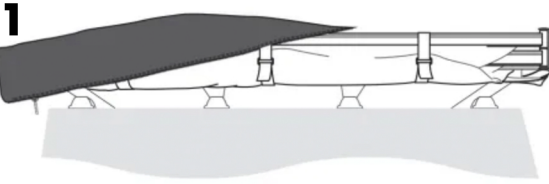



1

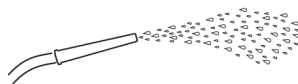
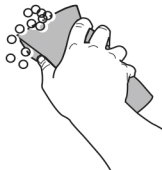

2

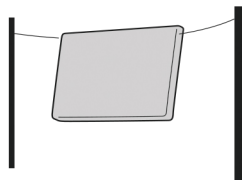
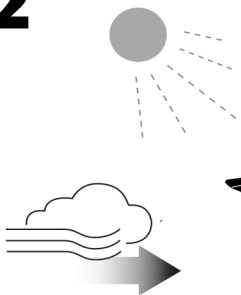

3

