



# Slim Rear View Camera

INSTRUCTION MANUAL

## Table of contents

- 1. Package ..... 3-4
- 2. Limited time warranty ..... 5
- 3. Care instructions ..... 5
- 4. Key Features ..... 5
- 5. Dimension(inch) & Wiring ..... 6-7
- 6. Specification ..... 8
- 7. Connection instructions ..... 9

\* Model  VTL275LTJ  VTL375LTJ  
 VTL405LTJ  VTL425LTJ

**BOYO**  
 Vision Tech America, Inc.  
 1452 E. Valencia Dr, Fullerton, CA 92831  
 Ph:888-941-3060

### 1. Package

1-1. VTL275LTJ / VTL375LTJ

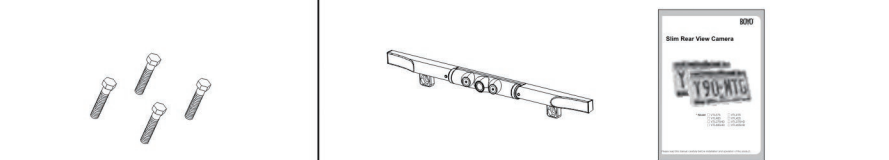

Slim Rear View Camera 1EA  
Instruction manual 1EA  
M6 Hex bolt 4EA



Spring washer 4EA  
Flat washer 4EA  
M6 Hex nut 4EA



1.5Ø L-Wrench 1EA  
Adaptor cable 1EA  
Registration card 1EA



24ft Extension cable 1EA  
Warranty card 1EA

### 1. Package

1-2. VTL405LTJ / VTL425LTJ

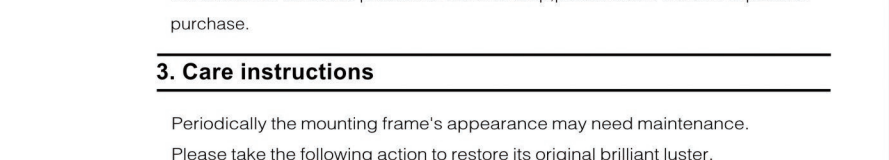

Slim Rear View Camera 1EA  
Instruction manual 1EA  
M6 Hex bolt 2EA

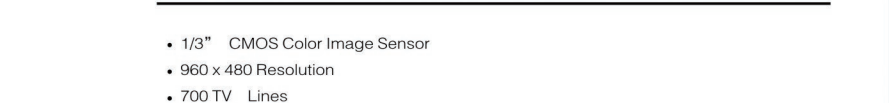

Spring washer 2EA  
Flat washer 2EA  
M6 Hex nut 2EA

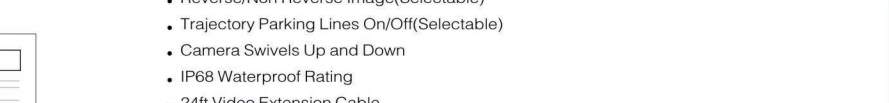

1.5Ø L-Wrench 1EA  
Adaptor cable 1EA  
Registration card 1EA

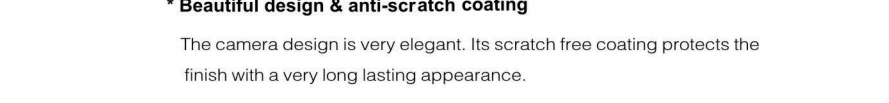

24ft Extension cable 1EA  
Warranty card 1EA

### 2. Limited time warranty

Limited time warranty applies only if care instructions are followed regularly.  
 In the event of defective product or workmanship, please return the item to place of purchase.

### 3. Care instructions

Periodically the mounting frame's appearance may need maintenance.  
 Please take the following action to restore its original brilliant luster.  
 Use non abrasive mild soap detergent and water only to clean.

### 4. Key Features

- 1/3" CMOS Color Image Sensor
- 960 x 480 Resolution
- 700 TV Lines
- 175 degree Wide Viewing Angle (D)
- Minimum Illumination 0 Lux at F2.0
- LED Lights For Excellent Night Vision
- Reverse/Non Reverse Image(Selectable)
- Trajectory Parking Lines On/Off(Selectable)
- Camera Swivels Up and Down
- IP68 Waterproof Rating
- 24ft Video Extension Cable
- Voltage Tolerance:9VDC-16VDC
- NTSC

### \* Beautiful design & anti-scratch coating

The camera design is very elegant. Its scratch free coating protects the finish with a very long lasting appearance.

### 5. Dimension(inch) & Wiring

5-1. VTL275LTJ / VTL375LTJ

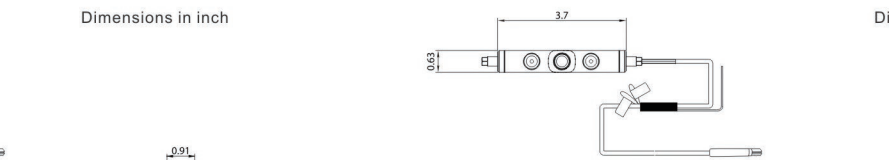

Dimensions in inch

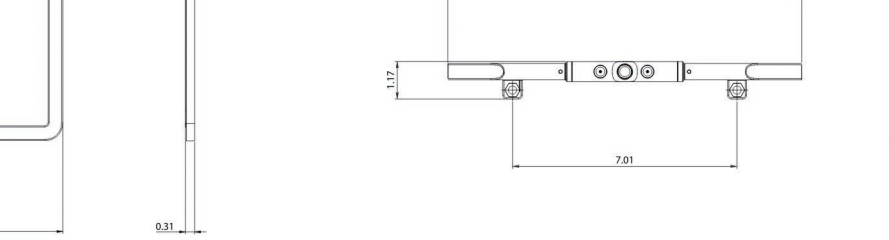

Dimensions in inch

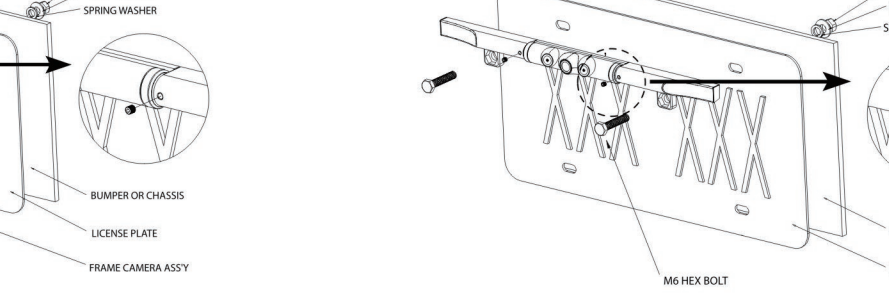

### 5. Dimension(inch) & Wiring

5-2. VTL405LTJ / VTL425LTJ

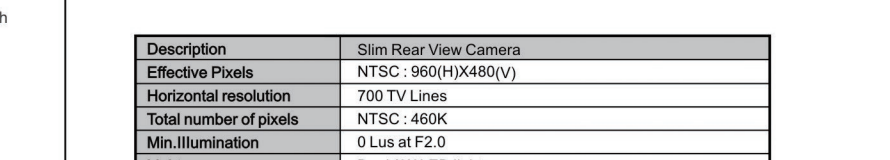

Dimensions in inch

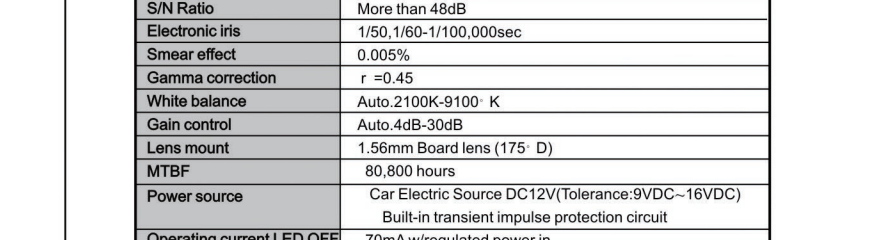

Dimensions in inch

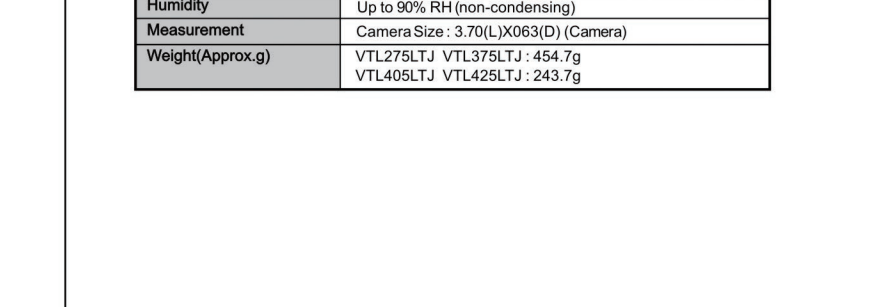

### 6. Specification

6-1. VTL275LTJ / VTL375LTJ / VTL405LTJ / VTL425LTJ

Description	Slim Rear View Camera
Effective Pixels	NTSC : 960(H)x480(V)
Horizontal resolution	700 TV Lines
Total number of pixels	NTSC : 460K
Min.illumination	0 Lus at F2.0
Light	Dual 3W LED lights
Synchronizing system	Internal
Scanning system	Interlaced
Video outp	1Vp-p 75 ohm composite
S/N Ratio	More than 48dB
Electronic iris	1/50, 1/60-1/100,000sec
Smear effect	0.005%
Gamma correction	r =0.45
White balance	Auto.2100K-9100 K
Gain control	Auto.4dB-30dB
Lens mount	1.56mm Board lens (175° D)
MTBF	80,800 hours
Power source	Car Electric Source DC12V(Tolerance:9VDC-16VDC) Built-in transient impulse protection circuit
Operating current LED OFF	70mA w/regulated power in
Operating Temp.	-4 F ~ 122 F (-20°C ~ +50°C )
Storage Temp.	-40 F ~ 176 F (-40°C ~ +80°C )
Humidity	Up to 90% RH (non-condensing)
Measurement	Camera Size : 3.70(L)x0.63(D) (Camera)
Weight(Approx.g)	VTL275LTJ / VTL375LTJ : 454.7g VTL405LTJ / VTL425LTJ : 243.7g

### 7. Connection instructions

7-1. VTL275LTJ / VTL375LTJ / VTL405LTJ / VTL425LTJ



### MEMO

### MEMO

### MEMO

### MEMO

### MEMO

### MEMO

### MEMO