

**BOYO**<sup>®</sup>  
VISION

Vision Tech America, Inc.  
1452 E. Valencia Dr.,  
Fullerton, CA 92831  
Tel:888-941-3060

For technical support contact 888-941-3060 or email  
[info@visiontechamerica.com](mailto:info@visiontechamerica.com) [WWW.VISIONTECHAMERICA.COM](http://WWW.VISIONTECHAMERICA.COM)

**BOYO**<sup>®</sup>  
VISION  
**VTM5000Q4**  
5" Quad Monitor User Manual



# VTM5000Q4



## 5"Quad monitor

- 1.Display mode
- 2.Menu
- 3.Power
- 4."-" decrease
- 5."+" increase
- 6.Remote control window
- 7.Bracket knobs

## Specifications

<b>Model</b>	VTM5000Q4
<b>Screen size</b>	5 inch
<b>Aspect ratio</b>	16:9
<b>Luminance</b>	350cd/ m <sup>2</sup>
<b>Resolution</b>	800*RGB*480
<b>Audio &amp; Video</b>	4 Ways video input,1 way audio input,4 ways triggers (For waterproof monitor no audio input)
<b>System</b>	PAL & NTSC manually selectable
<b>Voltage</b>	12V-24V
<b>Language</b>	Multi-language
<b>OSD Menu</b>	Display menu,Brightness,Color,Contrast adjustable
<b>Built-in speaker</b>	Yes
<b>Bracket accessories</b>	U type bracket
<b>Sunshade</b>	Removeable
<b>Mode</b>	Full/2/3/4 images adjustable
<b>Set up</b>	Mirror for individual image,Can set reserve delay

## Remote Control

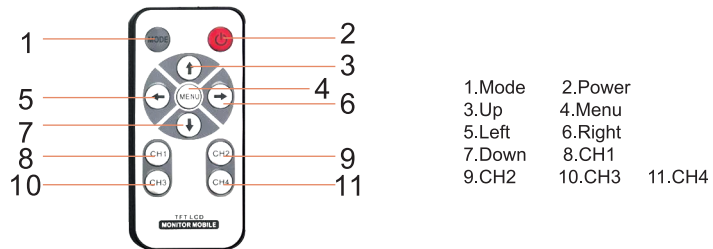

## Cable Description

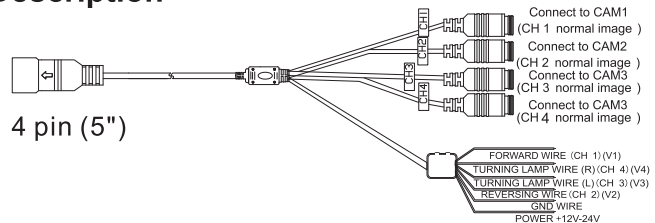

## Monitor Installation

1. Remove the screw around then take out the monitor. Put U type bracket to the right place and adjust, prepare 3 screws.

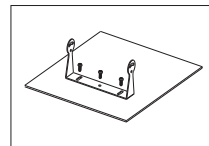
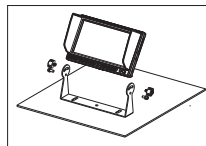



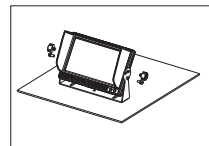
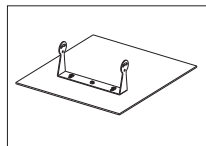

2. Locking the bracket by screws. Put the monitor into bracket, adjust angle and tighten.

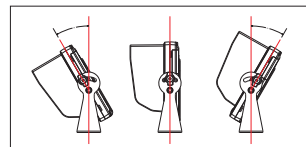
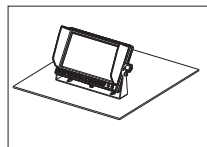

3. Finish installation. The adjustable angel is forward 30° and backward 30°. User can adjust a suitable angle by themself.



## Accessories

1.Remote control*1 PCS		2.User manual*1PCS	
			
3.Sunshade*1 PCS	4.Power cable 1 PCS	5.Bracket accessories*1 PCS	
			

## Cautions

1. The device may be powered by a 12 or 24 volt automotive battery or vehicle electrical system.
2. Make sure all cables are connected properly. Observe polarity. Improper cable connections may damage the monitor. Remove the power cable connections when you do not intend to use the unit.
3. High voltage inside. The enclosure will not be opened unless by professionals.
4. Do not watch any video while driving unless you are backing up the vehicle.
5. Occasionally, a few highlights or dark spots may occur on the LCD screen. This is a very common phenomenon in active matrix display technology, and doesn't necessarily indicate any defects or faults. Never try to repair this device by yourself. In case of any problems, please turn off the display at once and notify our company or authorized dealer. The monitor is a complex device. Any disassembly or modification may lead to damage and void the warranty.

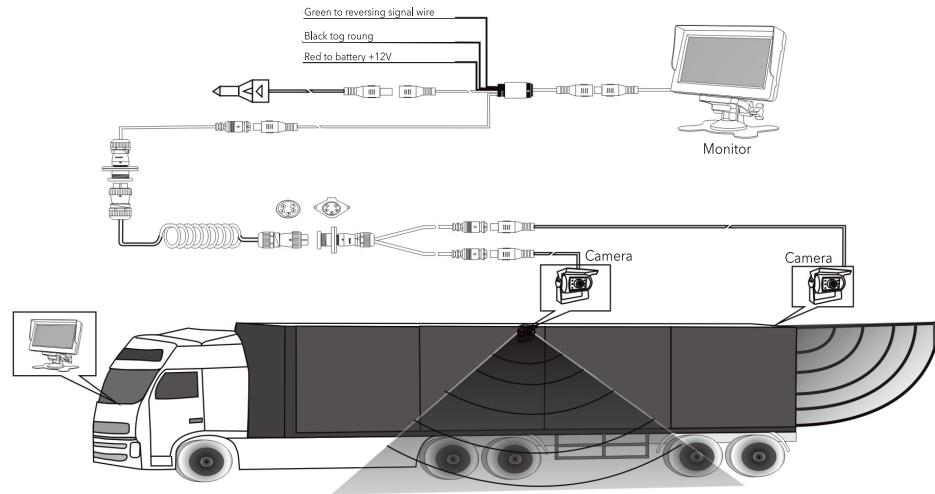

Monitor system can be used in truck,bus,RV and special vehicle