

Omni Power Station 30C+

User Manual

..omnicharge®



DISCLAIMERS: READ BEFORE USE

Acknowledgment: By using this product, you hereby confirm that you have thoroughly read and understood this manual, including all instructions, warnings, and safety information. Your use of the product constitutes your agreement to follow these guidelines and recommendations.

Warranty: Please refer to our warranty at: <https://www.omnicharge.co/pages/warranty-policy> (the "Warranty"). Unless otherwise expressly agreed by us in writing, the Warranty constitutes our sole warranty to this product.

Warranty Limitations: TO THE EXTENT PERMITTED BY LAW, THE WARRANTY AND THE REMEDIES SET FORTH THEREIN ARE EXCLUSIVE AND IN LIEU OF ALL OTHER WARRANTIES, REMEDIES AND CONDITIONS, WHETHER ORAL, WRITTEN, STATUTORY, EXPRESS OR IMPLIED. OMNICHARGE DISCLAIMS ALL STATUTORY AND IMPLIED WARRANTIES, INCLUDING WITHOUT LIMITATION, MERCHANTABILITY, FITNESS FOR A PARTICULAR PURPOSE, NON-INFRINGEMENT, QUIET ENJOYMENT AND COMPATIBILITY.

Limitation of Liability: EXCEPT AS PROVIDED IN THE WARRANTY AND TO THE MAXIMUM EXTENT PERMITTED BY LAW, (A) OMNICHARGE OR ITS AFFILIATES ARE NOT RESPONSIBLE FOR INDIRECT, SPECIAL, INCIDENTAL OR CONSEQUENTIAL DAMAGES RESULTING FROM ANY BREACH OF WARRANTY OR CONDITION, OR UNDER ANY OTHER LEGAL THEORY, INCLUDING BUT NOT LIMITED TO LOSS OF USE; LOSS OF REVENUE; LOSS OF ACTUAL OR ANTICIPATED PROFITS (INCLUDING LOSS OF PROFITS ON CONTRACTS); LOSS OF THE USE OF MONEY; LOSS OF ANTICIPATED SAVINGS; LOSS OF BUSINESS; LOSS OF OPPORTUNITY; LOSS OF GOODWILL; OR LOSS OF REPUTATION HOWSOEVER CAUSED, AND (B) UNDER NO CIRCUMSTANCES WILL OMNICHARGE'S AGGREGATE LIABILITY OF ALL KINDS ARISING OUT OF OR RELATED TO YOUR USE OF THE OMNICHARGE PRODUCT, REGARDLESS OF WHETHER ANY ACTION OR CLAIM IS BASED ON CONTRACT, TORT, OR OTHERWISE, EXCEED THE TOTAL AMOUNTS PAID YOU PAID TO ACQUIRE THE OMNICHARGE PRODUCTS. THE FOREGOING LIMITATION SHALL NOT APPLY TO DEATH OR PERSONAL INJURY CLAIMS, OR ANY STATUTORY LIABILITY FOR INTENTIONAL AND GROSS NEGLIGENT ACTS AND/OR OMISSIONS. OMNICHARGE DISCLAIMS ANY REPRESENTATION THAT IT WILL BE ABLE TO REPAIR ANY OMNICHARGE PRODUCT UNDER THIS WARRANTY. SOME STATES (COUNTRIES AND PROVINCES) DO NOT ALLOW THE EXCLUSION OR LIMITATION OF INCIDENTAL OR CONSEQUENTIAL DAMAGES, SO THE ABOVE LIMITATION OR EXCLUSION MAY NOT APPLY TO YOU.

Environmental Compliance: You are responsible for complying with local regulations for product disposal at the end of life. We are not liable for any harm due to improper disposal.

Use at Own Risk and Third-Party Products: This product is designed for specific purposes as outlined in this manual and is intended for use with third-party products that meet the criteria and specifications described in the manual. We are not liable for any harm, loss, or damage resulting from use outside its intended purpose or contrary to this manual's instructions.

Modifications: To the extent that any disclaimers of warranties or limitations of liability set forth in this manual are not permissible under the applicable laws of the user's jurisdiction, such disclaimers and limitations shall be modified to preserve the intent of these provisions to the greatest extent permitted by the applicable laws.

SUMMARY

POWER STATION INTRO	1
WHAT'S IN THE BOX	3
GETTING TO KNOW THE POWER STATION	4
SETTING UP THE POWER STATION	5
POWER STATION SAFETY & HANDLING	6
PORTABLE CHARGER INTRO	7
PORTS AND POWER	9
INTERFACE	11
RECHARGING YOUR PORTABLE CHARGER	12
PORTABLE CHARGER SAFETY & HANDLING	13
TECHNICAL SPECIFICATIONS	14
TROUBLESHOOTING	15

POWER STATION



.:omni**charge**®

Omni Power Station

The Omni Power Station is an all-in-one solution to help you distribute power wherever, and whenever it's needed. The Omni Power Station is designed for forward-thinking organizations that understand the need to provide portable power access to people so they can stay powered anywhere, on or off-site, without being tethered to fixed infrastructure constraints.



Flexible design



Avoid downtime



For all devices



Easy deployment



**All in one power
solution**



**Fast and easy
deployment**



**Plug & Play
system**

WHAT'S IN THE BOX

The Omni Power Station comes with everything you need to get started, including the portable charger, the base station, and the power cable.



**BASE
STATION**

**8
PORTABLE CHARGERS**

**AC
POWER CABLE**

**USER
MANUAL**

GETTING TO KNOW THE POWER STATION

The Omni Power Station is a simple plug-and-play device. Just plug into an AC outlet, and you are ready to go.

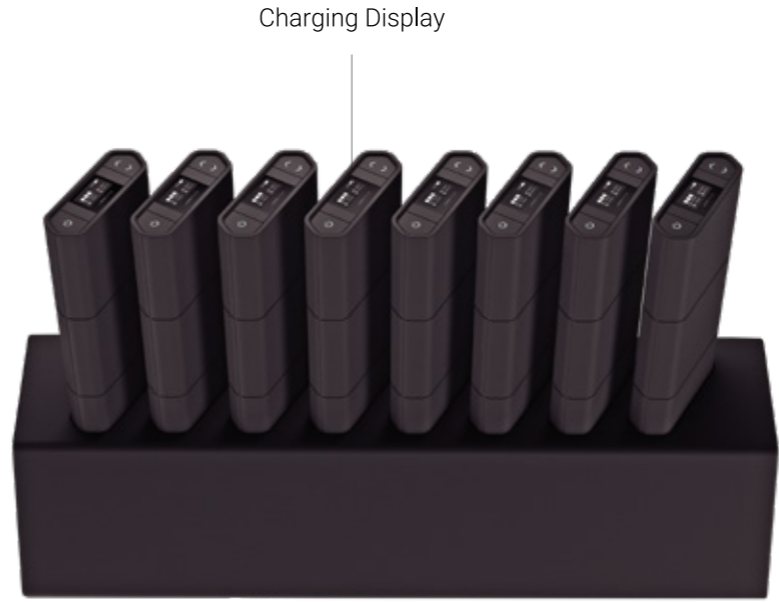

Charging Display

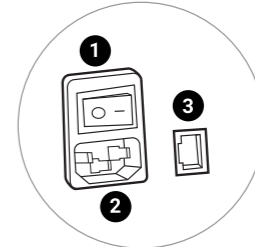

- 1- Power Switch
- 2- Power Plug
- 3- Ethernet Port

SETTING UP THE POWER STATION

Before setting up your Power Station, make sure you have a suitable location. Do not place the station in direct sunlight, next to an active heat source, or in an environment that is excessively dusty.

STEP 1:

Place the chargers into the open bays with the DC port facing downwards and the screen facing upwards.

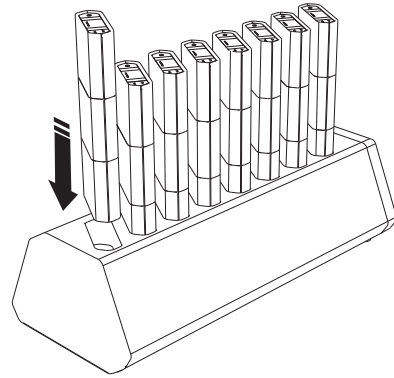

STEP 2:

Plug the AC power cable into the base of the power station, and connect it to a power outlet.

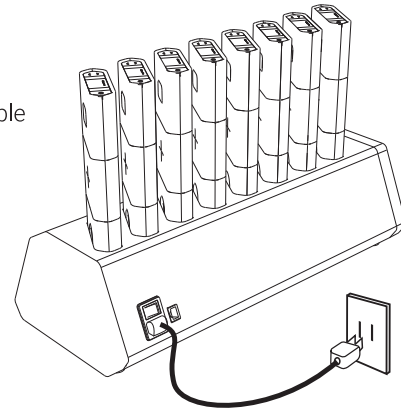

STEP 3:

Press the power button on the back side of the powerstation to turn it on.

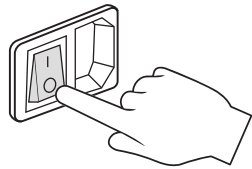

STEP 4:

Wait until the charging icon displays in all the charger screens, meaning it is well connected and charging the Portable Charger.

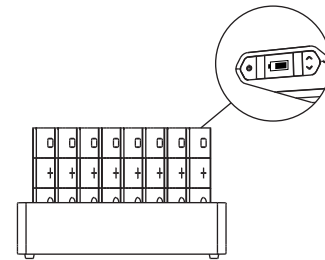

Note: The chargers require no force when connecting them to the charging bay. Make sure the charger is level when pushed into the slot and not crooked. Never force the Portable Charger into the charging base.

POWER STATION SAFETY & HANDLING

WHEN SETTING UP THE POWER STATION



Set up your Power Station on a hard, flat, and stable work surface which allows for adequate air ventilation around the unit.



We recommend placing the Power Station with a minimum 10cm gap from any wall and maintaining a distance of at least 30cm between each Power Station.



Do not install the Power Station in an environment where heat can easily accumulate, this will cause the batteries to overheat. The optimal temperature 10°C-40°C. Altitude ≤ 2000m



Install the Power Station in a dry location, away from high humidity as moisture and oxidation of internal electronic components can impact performance and safety. Optimal humidity 30-70% .



The maximum power for each Power Station is 450W. Please use a socket that is suitable for this power rating and avoid overloading.



Please use the original power cable and avoid using other brands or models. Inappropriate power cables may damage your power station or pose safety risks.



Avoid bending or crushing the power cable, as repeated stress can weaken it. Don't place objects on the cable, and refrain from using it if it's damaged.



The Power Station must be grounded. Never operate your Power Station in the absence of a suitably installed ground conductor.



Failure to follow these safety instructions can result in fire, electrical shock, injuries, or damage to your Power Station or other property. Inappropriate use of the Power station may cause long term damage to the battery cells, and may void your warranty.

AVOID PLACING THE POWER STATION:



Inside a cabinet



In direct sunlight



Close to heat sources like heaters, or microwaves.



Near flammable gasses or combustible materials.

WHEN STORING THE POWER STATION



If your Power Station or Portable Chargers are not in use for more than a week, we recommend turning them off.



Shut off the Power Station power, disconnect the power cable and power down the chargers.



Store the powerstation in a cool and dry location. The optimal storing temperature is 10°C-40°C and humidity is 30-70%.



Before cleaning your Power Station, disconnect it, remove the Portable Chargers, and power them down. Use a dry cloth to clean; avoid liquid and operating with wet hands.



..omni**charge**®

Omni Portable Charger

The Omni Portable Charger is the perfect professional power solution, offering speed, versatility, and reliability. It's perfect for charging laptops, cell phones, and all your essential tech on the move. With high-power capabilities, including a 100W DC outlet, 100W USB-C port, and 3 rapid wireless charging options, it's your go-to source for flexible and dependable power in any situation. This Portable Charger offers four different charging methods, ensuring all your devices stay powered up effortlessly, anywhere.



10W
WIRELESS



5W
WIRELESS



3W
WIRELESS



100W
DC PORT



100W
USB-C PORT



2X 18W
USB-A PORT



Earbuds
Up To 30 Charges



Smartwatch
Up To 45 Charges



Smartphone
Up To 4 Charges



Tablet
Up To 2 Charges



13" Laptop
Up To 2 Charge



DSLR Camera
Up To 10 Charges

WIRELESS CHARGING MAX OUTPUT 10W

+ CHARGING PHONES MAX OUTPUT 10W

Place your phone on top of the Omnicharge's "+" icon to get fast and reliable wireless charging. For optimal wireless charging, align your phone horizontally in the center of the Omnicharge as shown in the picture.

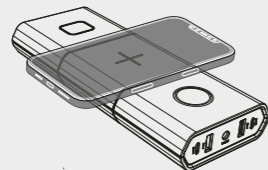

□ CHARGING EARBUDS MAX OUTPUT 5W

Place your wireless charging compatible earbuds on top of the Omnicharge's (□) icon to start wireless charging.

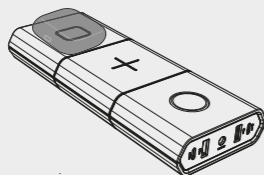

○ CHARGING SMARTWATCHES MAX OUTPUT 3W

Place your smartwatch horizontally on top of the Omnicharge's (○) icon to start wireless charging.

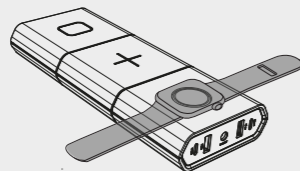

You will see a flashing wireless icon when a wireless device has been detected.

Note: The optimal charging range varies depending on the size of the receiver coil of your phone. Some phone models have small receiver coils and can experience sudden interruptions after few seconds of charging. This is because of minor alignment deviations between the transmitter and receiver coil. Please lift up the phone, wait a few seconds and finetune the position until you get a stable wireless charge.

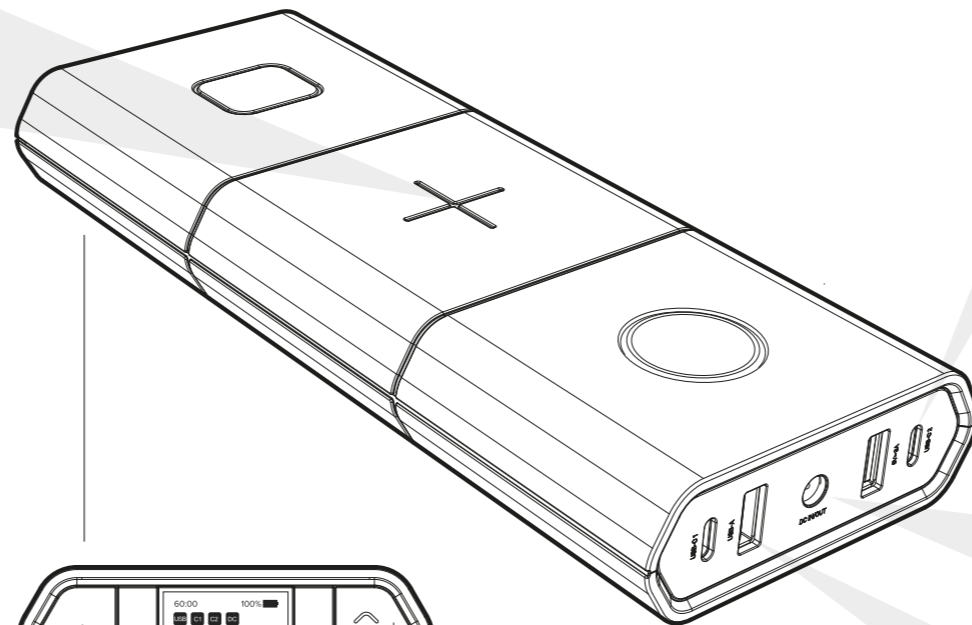

1 Power & Menu Button
2 OLED Screen
3 USB & DC Selector

USB-C PORTS MAX OUTPUT 100W

Note: The USB-C Port1 and DC port share the same power circuit and cannot be used at the same time.

USB-C Port 1: 100W Max
USB-C Port 2: 100W Max

The USB-C ports are always on and need no configuration. Simply plug your USB-C device into any USB-C port to start charging.

DC PORT MAX OUTPUT 5A - 100W

5V - 25V
WITH 0.1V ACCURACY

The DC output feature allows you to directly output DC power through the barrel port. To use this feature you will need to know the voltage and amperage of your device and have a compatible cable.

Warning: Using the wrong voltage may damage your device.

Enabling DC Output

Step 1	Step 2	Step 3
DC OUT USB SCREEN OFF AUTO SHUT DOWN	15.0V = 5.0A 16.5V = 5.0A 20.0V = 5.0A 12.0V = 5.0A	Confirm 20.0V = 5.0A? ● Yes ○ No Incorrect setting may harm your device.

DC Once active, a DC icon will appear on the screen.

Omnicharge keeps 4 voltage presets. You can press and hold the power button while selecting a preset to customize the voltage and amperage.

USB-A PORTS MAX OUTPUT 18W

USB-A Ports: Quick Charge QC3.0 compatible, 18W Max

SCREEN

OLED screen with real time metrics

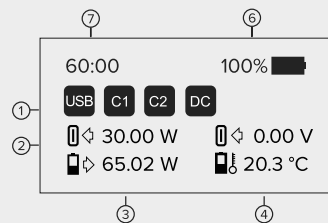

1. Status Icons
2. Power Input (watts)
3. Battery Power Output (watts)
4. Battery Temperature
5. DC Output Voltage
6. Battery Percentage
7. Time Remaining

BUTTON FUNCTIONS

PRIMARY CONTROLS

- Long press to power On
- Long press to power Off
- Up Button: DC Outlet
- Down Button: USB/Wireless

MENU CONTROLS

- Double press to enter the menu
- Quick press to select
- Up Button: Move up
- Down Button: Move down

MENU NAVIGATION

Double press the power button to access the menu, quick press it to select any function, and use the AC and USB buttons to move up or down.

1. DC OUT

Turn on DC output. Set the voltage and amperage by long pressing the power button.

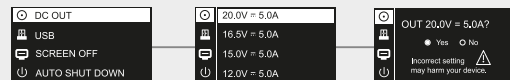

6. BUTTON LIGHT

Choose whether the button lights are on or off. The default setting is on.

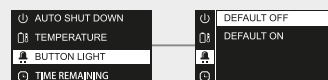

2. USB

Choose whether your USB-A ports are On/Off at start. The default setting is on.

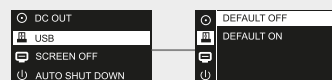

7. TIME REMAINING

Choose whether the time remaining is displayed.



3. SCREEN OFF TIMER

Set the screen auto shut-off time. The default setting is 5 min.



8. LANGUAGE

Choose the screen language.



4. AUTO SHUT DOWN

Set the power auto shut-off time. The default setting is 8 hour.



9. FACTORY RESET

Reset the Omnicar to factory settings.



5. TEMPERATURE

Choose whether the temperature is displayed in celcius or fahrenheit.



10. ABOUT

Find the model name, capacity, firmware version, and serial number information here.



RECHARGING YOUR PORTABLE CHARGER

Charging time 4-6 hours

RECHARGE FROM THE POWER STATION

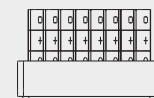

Return the Portable Chargers to the Power Station charging base for optimal charging. A battery icon should appear on the screen to confirm proper charging.

BALANCED BATTERY CHARGING MODE

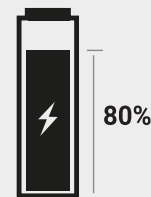

Upon reaching a full 100% charge, the Portable Charger will automatically discontinue the charging process. To ensure optimal battery health, if left unused for an extended period, the charger will self-deplete to 80%. Please note that it is normal for the charger not to maintain a constant 100% charge, as this proactive measure is designed to promote longevity.

BATTERY MAINTENANCE

The Portable Charger uses lithium battery cells which have a limited number of cycles depending on usage and environment. Use the following guidelines to help maximize battery life. Once the batteries are depleted beyond usage, they will need to be replaced.

- Try to balance the usage of your Portable Chargers. Excessive use of a single battery can shorten the lifespan of the battery cells.

- Lithium batteries should not be left charging on the station constantly without use. If your power station is not in use for more than a week, we recommend turning the station and chargers off and topping them up every 3-4 months.

- Adhere to the guidelines for proper handling and storage of the Power Station and Portable Chargers to prevent unnecessary depletion of their battery life.

- Any battery that fails due to misuse, abuse, age, or improper maintenance, is not covered by our warranty.

BATTERY HEALTH MONITORING

The Portable Charger includes a dynamic battery health and power monitoring system. It adjusts recharge and rest times for lithium batteries, along with power output, based on battery conditions and the environment.

You'll be notified on-screen if potential overuse due to battery depletion or end of life, prior to any permanent deactivation.

1. When the following screen alert appears, you'll be able to use the Portable Charger but the unit will soon need to be replaced.



2. When the following screen alert appears, the battery has reached its end of life and has deactivated. Please replace the unit.



PORTABLE CHARGER SAFETY & HANDLING



Inspect the Portable Charger for any type of damage before use. If damaged when using it, stop using it, do not place it back to the station, and notify your supervisor for a replacement.



The Portable Charger is designed for indoor use only. Set up your Portable Charger on a hard, flat, and stable work surface which allows for adequate air ventilation around the portable charger.



Do not place or use the Portable Charger in high-temperature environments, including heat caused by intense sunlight or other forms of heat like inside a car, next to a radiator or heater.



The Portable Charger may be damaged if dropped or exposed to strong shock, punctured or crushed, subjected to heat or fire, or in contact with any liquids, moisture, or corrosive chemicals.



If the unit does not turn on, or there is a warning notification on the unit, immediately stop using, do not place it back on the station, and inform your supervisor to replace the unit.



The Portable Charger is not user serviceable. Do not attempt to replace or modify the Portable Charger yourself, this may damage the battery which can cause overheating, fire or injury.



Dispose of your device's battery through an authorized provider in compliance with local environmental regulations, or contact support@omnipower.co for disposal assistance.



Failure to follow these safety instructions can result in fire, electrical shock, injuries, or damage to your Portable Charger or other property. Inappropriate use of the Portable Charger may cause long term damage to the battery cells, and may void your warranty.

NOTICE

This product is meant for use only in conjunction with appropriate devices. Please consult your device packaging to determine whether this product is compatible with your particular device. The manufacturer is not responsible for any damages to any device incurred through the use of this product. The manufacturer shall not in any way be liable to you or to any third party for any damages you or any third party may suffer as a result of use, intended or unintended, or misuse of this product in conjunction with any device or accessory other than the appropriate device for which this product is designed. You are responsible for product use with an unintended device and any damages resulting from such use. You agree to indemnify the manufacturer for any resulting injuries to any third party(ies).

GENERAL

POWER STATION

Weight w/ units (8x): 11.8 Kg (26.0 lbs)

Dimensions w/ units (8x): 486mm x 184mm x 304mm (19.1 x 7.2 x 12 in)

PORTABLE CHARGER

Weight: 1.53 lbs (693 g)

Dimensions: 8.3"x3.3"x1.15"(210x84x29 mm)

Combined output all ports: 100W

PORTS & POWER

USB-C

PD enabled charging

Input: (USB-C1) 5V \equiv 3A, 9V \equiv 3A, 12V \equiv 3A, 15V \equiv 3A, 20V \equiv 3A, 30W Max

Output: (USB-C1/C2)

(Single) 5V \equiv 3A, 9V \equiv 3A, 12V \equiv 3A, 15V \equiv 3A, 20V \equiv 5A, 100W Max

(Both) 5V \equiv 3A, 9V \equiv 3A, 12V \equiv 3A, 15V \equiv 3A, 20V \equiv 2.25A, 45W Max each

USB-A OUTPUT

Port1: QC 3.0 5V \equiv 3A, 9V \equiv 2A, 12V \equiv 1.5A, 18W Max

Port2: QC 3.0 5V \equiv 3A, 9V \equiv 2A, 12V \equiv 1.5A, 18W Max

OUTPUT

24V 1.5A (per charging bay)

INPUT

100V - 240V~, 50/60Hz, up to 4A (8x)

OPERATING ENVIRONMENT

Temperature 10°C-40°C

Humidity 30-70%

Altitude \leq 2000m

DC PORT

Bidirectional Input/output charging

Input: 5~25V, up to 3A, 30W Max

Output: 5~25V, up to 5A, 100W Max

WIRELESS CHARGING

Output: 10W+5W+3W

CAPACITY

8 cells, 94Wh (+/- 5%)



Li-ion



MADE IN CHINA

© 2024 Omnicarage.

∴ omnicarage® is a Registered trademark.

Product specifications are subject to change without notice or liability, whether to improve reliability, function, design or for any other reason.

TROUBLESHOOTING

How to get in contact with us

If your Power Station or Portable Chargers encounter any technical problems or if you have any inquiries about your Power Station please contact us via:

✉ support@omnipower.co

Before getting in contact with us, please make sure to prepare the information below so that we can give the best service and track your inquiry accordingly.

- The Station PI Address
- The Station Serial Number
- The Charger Serial Number
- Purchasing information (Receipt, PO, Order ID.)

Where to find the PI Address Number and Serial Number of your product.

Power Station:

Place the Power Station on one side, the PI Address and Serial Number stickers are located on the back side of the Power Station.

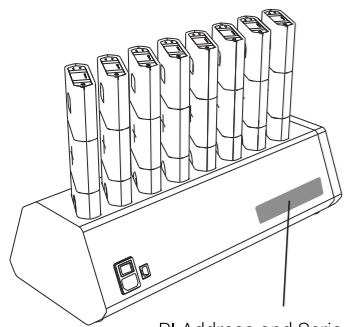

PI Address and Serial Number

Portable Charger:

Each Portable Charger is engraved with a Serial Number located at the back side.

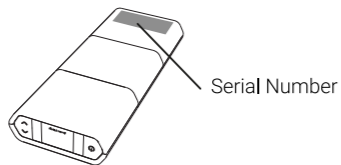

You can also find the Serial Number of each Portable Charger in the About section of the menu.

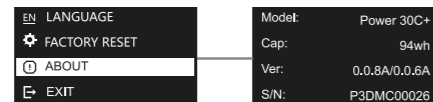

For complete troubleshooting information, Omnicarge provides a forum and detailed FAQ page where you can find the most common inquiries:

www.omnicarge.co/powerstation-faq



Scan to go to the troubleshooting page

If you can't find what you are looking for, please do not hesitate to contact us.



 **omni**charge[®]
www.omnicharge.co