

# Instructions For Translucent Three Fullness Box Pleat Shirring Tape (22-TT29)

## Translucent Tape Advantages:

- Excellent for sheer fabrics.
- Less obvious when used with any fabrics.
- Creates box pleats on panels, top treatments etc. quickly and automatically.

## Introduction to Translucent 3 Fullness Box Pleat Shirring Tape :

In the picture below, the draw cords were slightly pulled out to show the spaces and pleats.

**Do Not Do This To Your Tape!**

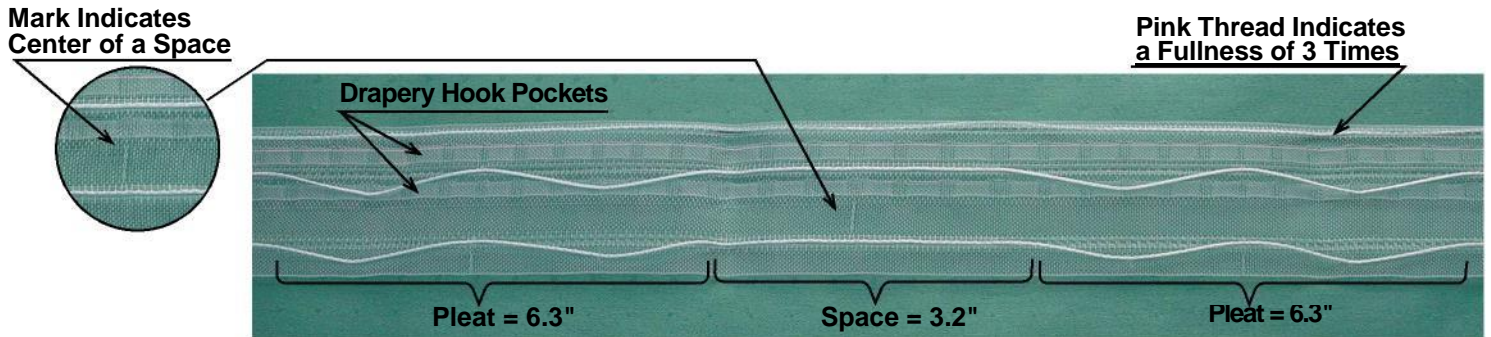

## Step By Step Instructions:

### 1. Hardware considerations and panel length:

- 1a. Many rods with rings or glides, our pleat pin strips (Stock #: **HS210**), can be used with these translucent shirring tapes. The two-prong drapery hooks (Stock #: **DP20**) should be used with these types of hardware.

#### To determine Panel Finished Length:

Measure from the holes of the track (**A**), or from the eyes of the glides (**B**), or from the screw eye at the bottom of the ring (**C**), add  $\frac{3}{8}$ \"

#### Fabric Length Requirement:

**Panel Finished Length  
+ Allowance for a Double Folded Bottom Hem  
+ 5\"**

The translucent tape must be positioned so that the top of the tape is even with the top edge of the panel. The hardware is often not sufficiently covered by the treatment. In that case, you need to plan a top treatment in front to conceal.

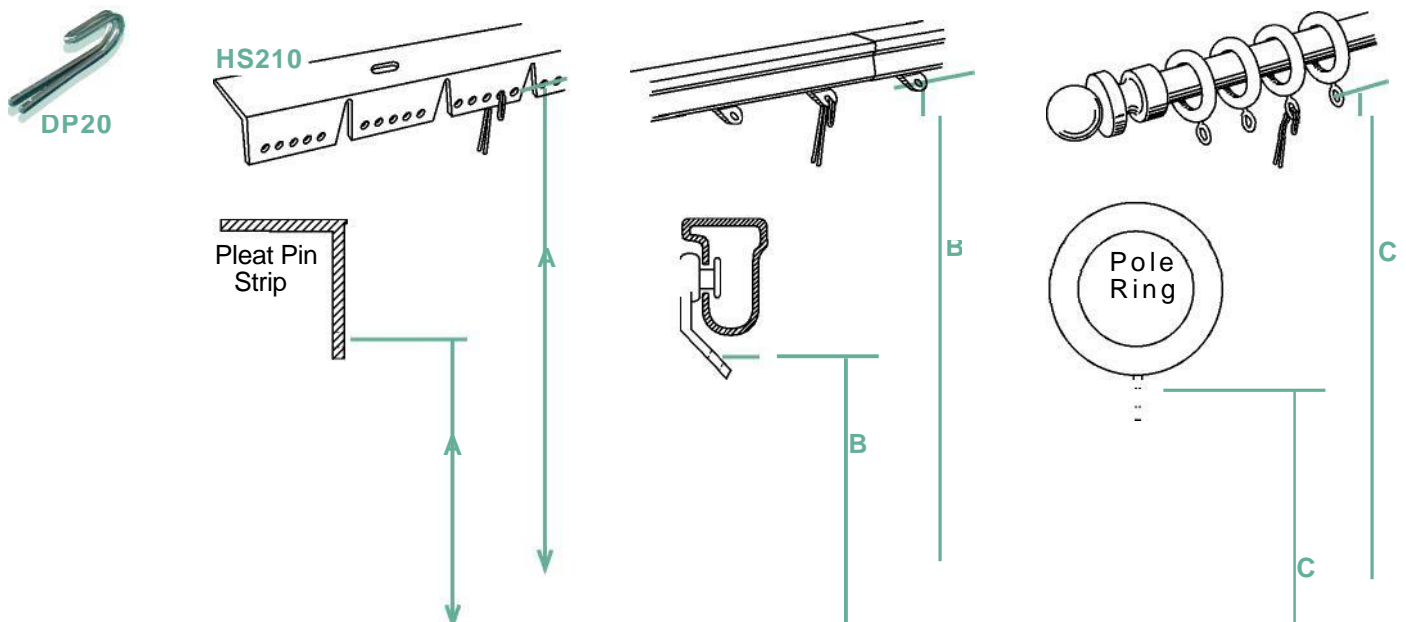

**1b.** Certain sizes of curtain rods can also be used. If rods are used, drapery pins (Stock# **DP50**, **DP53**) must be used. However the drapery header has a tendency to dip forward when drapery pins are used.

The top edge of the tape must be even with the top edge of the panel. To conceal the hardware and drapery pins, pierce the pin directly into the tape at the appropriate height.

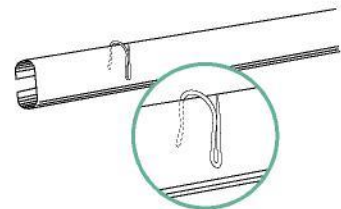

## 2. Planning for panel width:

Three typical panel arrangements are shown below.

The abbreviations are explained as follows:

**FW:** Panel finished width excluding return and overlap.

**R:** Return.

**O:** Overlap. In Figure (2), although the flaps do not actually overlap, we will still call them overlaps for simplicity.

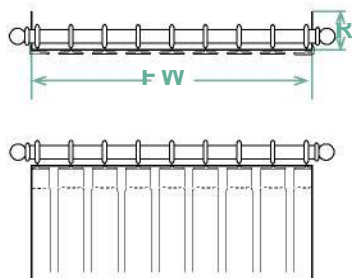

(1) A single stationary panel

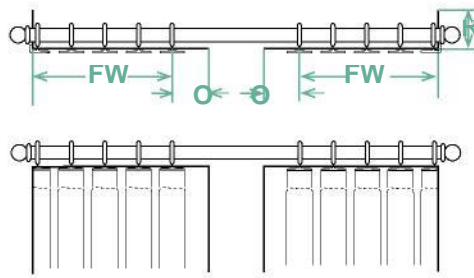

(2) A pair of stationary panels not meeting in the center

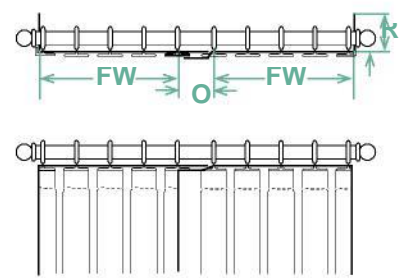

(3) A pair of panels meeting in the center

The calculations outlined below will let you make a finished panel width the same or slightly wider than what is required. This is due to the fixed spacing of the tape. The slightly wider finished width will never be a problem for a pair of panels not meeting in the center (Fig. 2). However, for a single stationary panel (Fig. 1) or a pair of panels meeting in the center (Fig. 3), and if the panel widths are extremely narrow, the extra width may cause panels to not hang evenly.

**Step 1.** Estimate the **Number of Spaces** per panel using desired finished width excluding return and overlap:

**Finished Width Excluding Return & Overlap | 3.2**

Always round the answer up to the nearest whole number to get the number of spaces. (e.g. if answer is 13.2, the number of the spaces is 14).

**Step 2.** Calculate the flat **Panel Width Excluding Return and Overlap:**

**# of Spaces x 9.5 + 6.3**

**Step 3.** Calculate the complete panel width.

**Panel Width Excluding Return and Overlap + Return + Overlap.**

**Total Fabric Width Requirement :**

**Complete Panel Width + Allowance for Side Hems + Allowance for Seams if any.**

## 3. Assemble the panels:

Fully assemble the panels to the size as shown in the figure below. Fold the 5" top flap to the back side and press.

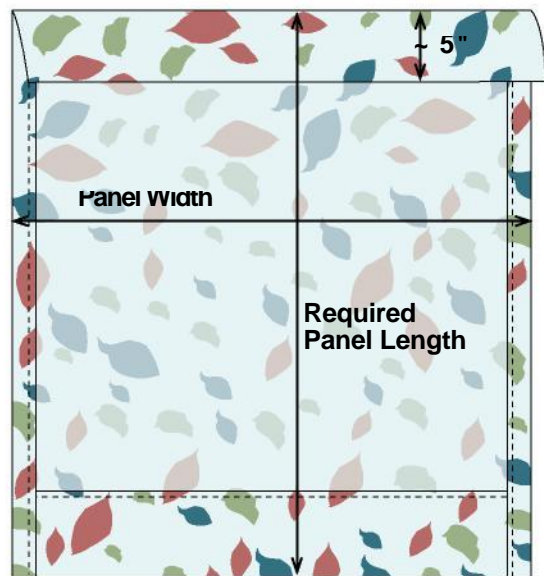

4. **Cut the tape:** On the tape, find the end of the first complete space and mark it with a pin (#1). From pin #1, measure the **Panel Width Excluding Return and Overlap** and mark it with another pin (#2). Add return or overlap to both ends (pins #3 and #4). Cut the tape 1" beyond the marking pins, #3 and #4.

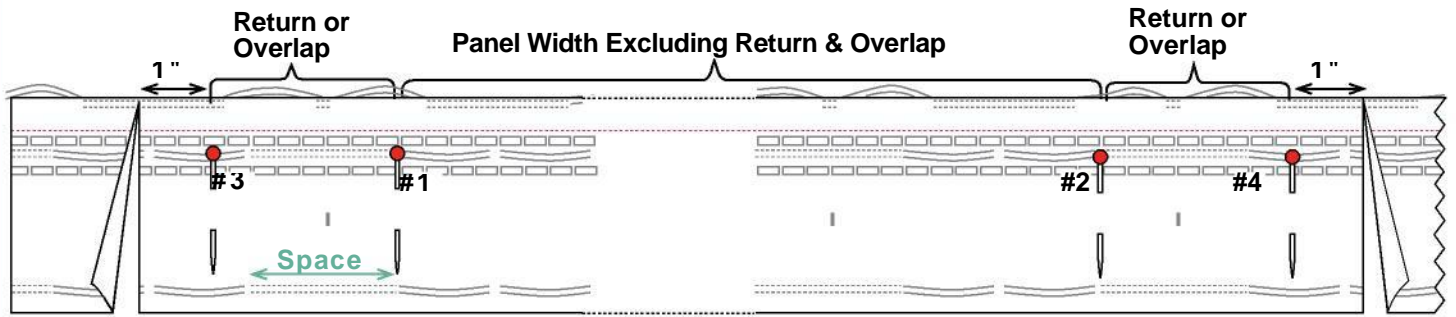

5. **Free the draw cords:** Between Pin #1 and Pin #3, find a space center marking. Free the draw cords at the center marking. Do the same between Pin #2 and Pin #4. make sure the freed draw cords come out from the side of the tape with hook pockets. On one end, knot each draw cord. If the tape is for a pair of panels, make sure the knots are at the overlap end. Trim off the extra cords. Fold 1" raw edges behind the tape.

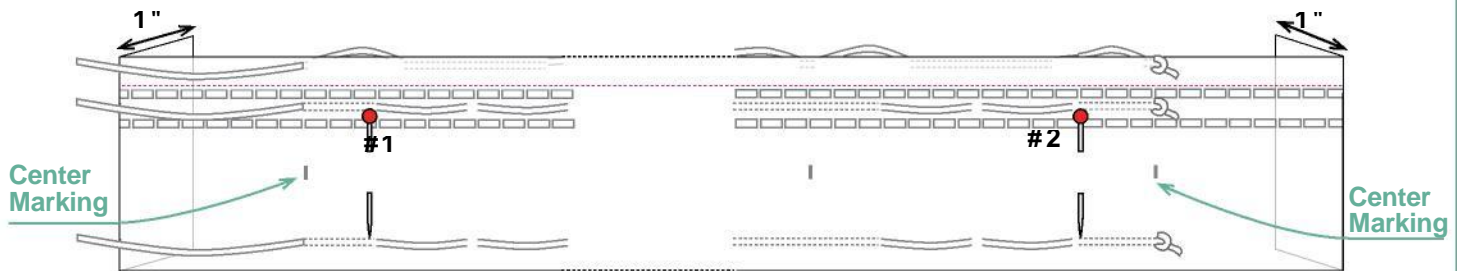

6. Lay the fabric panel on your worktable face down. Lay the tape on the panel header with the hook pockets up. The woven in pink thread must be nearest the top edge of the panel. The top edge of the tape must be even with the top edge of the panel. Trim off extra fabric so that the raw edge is covered by the tape. Pin the tape to the panel.

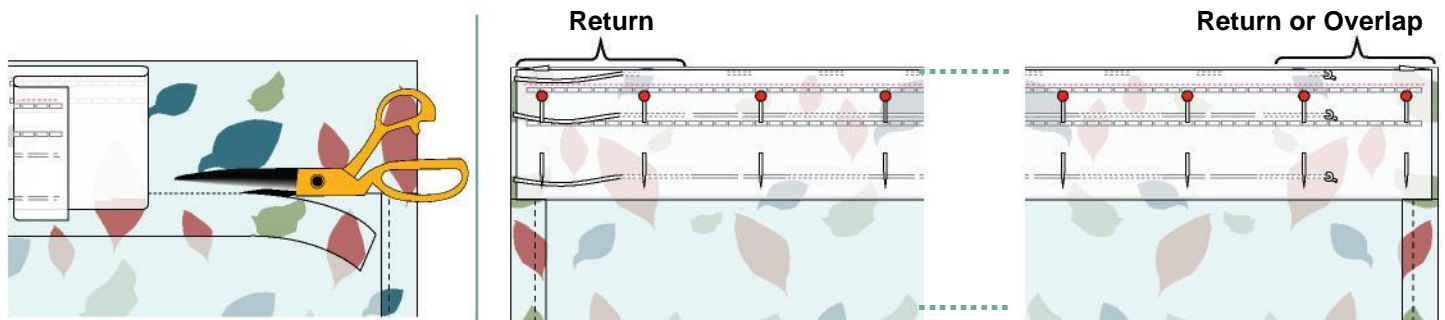

7. Sew one straight stitch line between the top draw cord and the woven in pink thread. Sew second straight stitching line along the bottom edges of tape. Make sure not to sew over the draw cords or hook pockets. Sew both stitching lines in the same direction to prevent puckering.

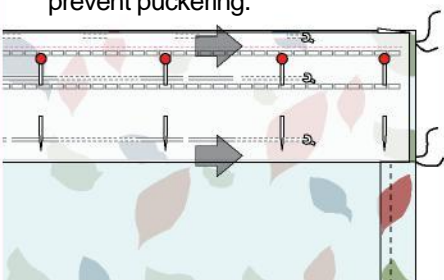

8. Pull the loose cords to gather the tape. Gather to the panel finished width. Go back to adjust if necessary. Make knots in the cords near the tape to hold the gathered width.



9. Wind the excess cords to make a neat bundle. Catch the cord bundle with two stitches to the panel or with a safety pin.

If two-prong hooks are to be used, go to **10a**. If drapery pins are to be used, go to **10b**.

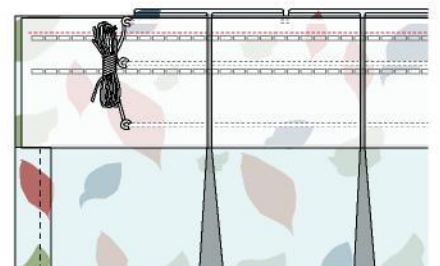

### 10a. Insert two prong hooks:

One hook is needed at the back of each set of pleats and at each end of the panel (4).

Insert one of the two prongs into each of the two adjacent pockets (1). Pull both prongs through, while flipping the hook (2). The hook is now securely inserted (3).

Hang the panel by inserting hooks into eyes of the pole rings, glides or the holes in the strip as shown at the right (5).

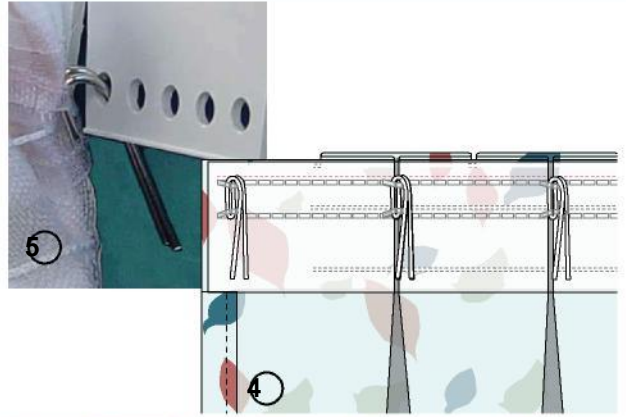

### 10b. Insert drapery pins:

Pierce the pins directly into the tape at the appropriate position, one pin at the back of each set of the pleats and at each end of the panel (1). Hang the panel on the curtain rod as shown (2).

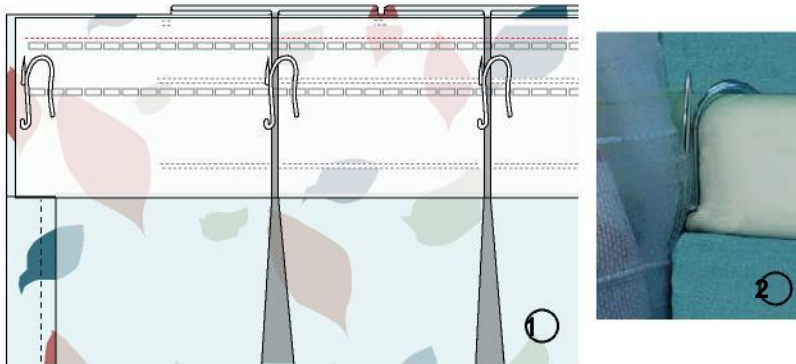

### Tip:

To better define the pleats, one may insert a tacking fastener (Stock #: **ST27**) at the base of each pleat group with tacking gun (Stock #: **ST26**).

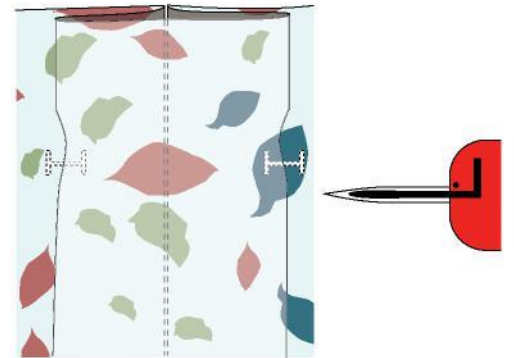

### Note:

1. The tape will not let you pleat seams under if the treatment is pieced together with multiple widths of fabrics. This is true for any automatic pleating tapes. Railroaded or using wide width fabric eliminates any seams.
2. The instructions deal mainly with the application of the tape. Detail of how to make a particular treatment is beyond the scope of this instruction and should be found in numerous instructional books.
3. These tapes are well suited for stationary panels, but not traversing panels.

