

# Technical Information

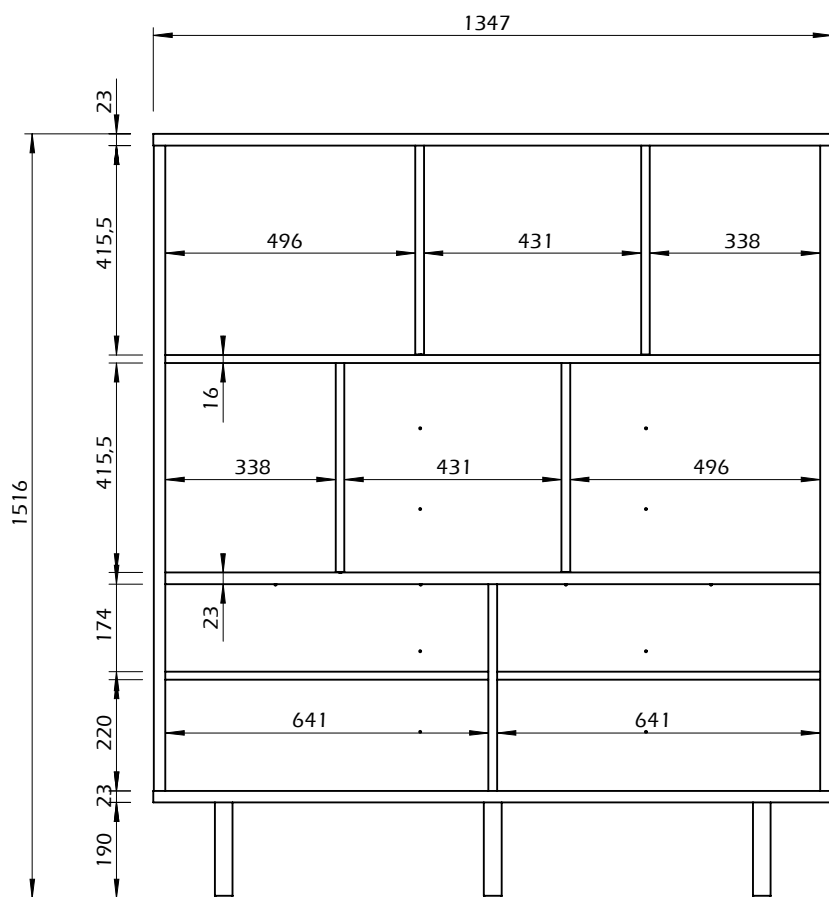

TEMAHOME

DANN

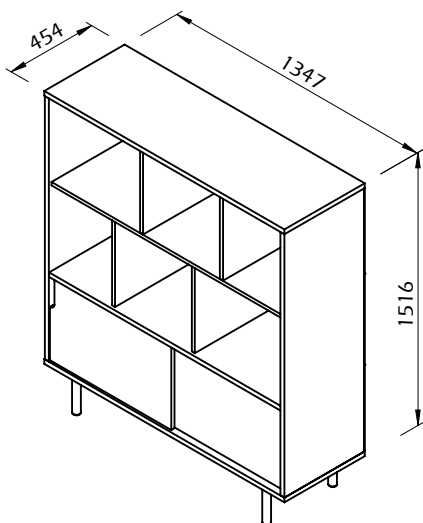

45min

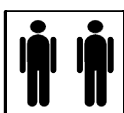

50kg