

# Technical Information

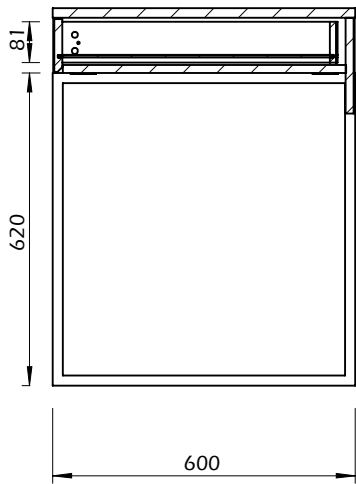

TEMAHOME

## PRADO

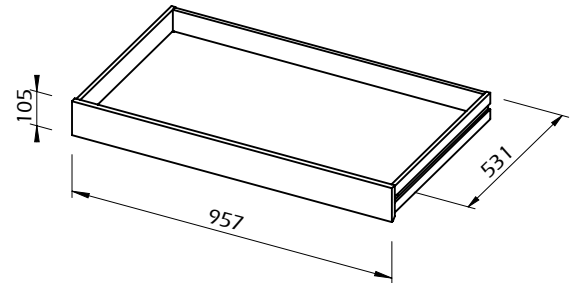
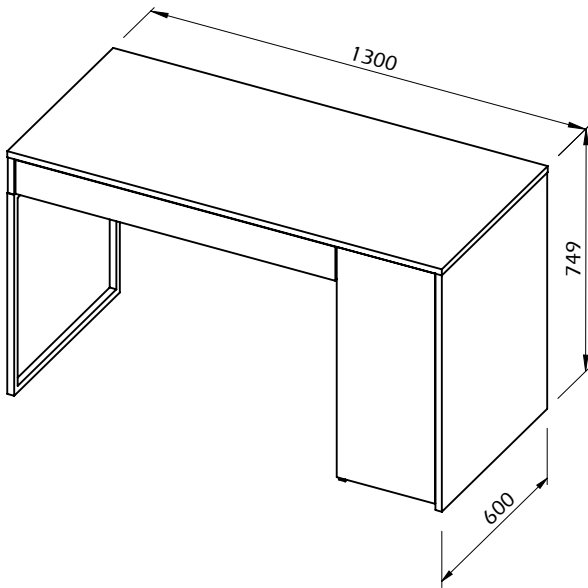

SECTION A-A

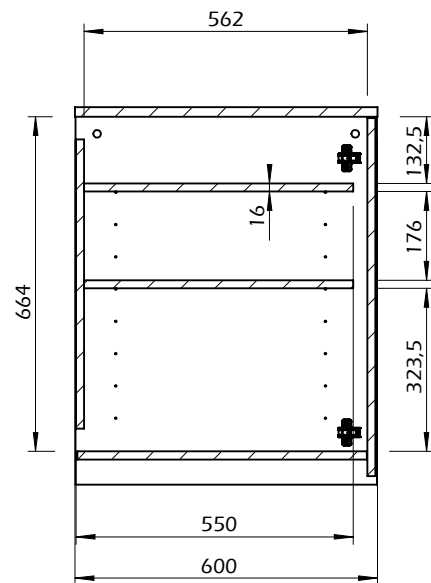
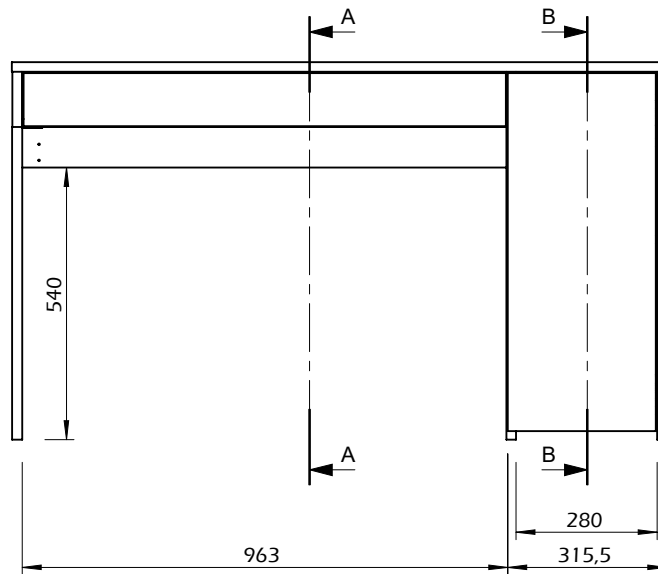

SECTION B-B

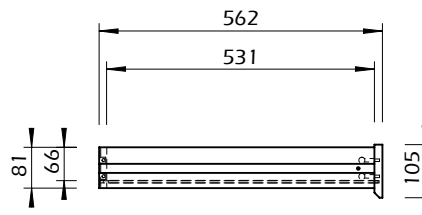
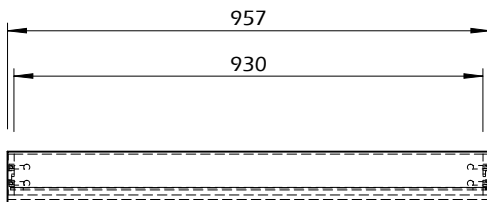

30min



20kg