

名称：宿霞ECCOTEMP 12升ZBA1顶排说明书

绘制：林干梅 2009.7.9

校对：

审核：

注：1、封面及内页均为单色印刷；

2、黑色外边框为说明书的纸张大小，产品中没有；

3、封面用128g铜板纸，内页用80g双胶纸。

Eccotemp Systems, LLC
315-A (I) industrial Road
Summerville, SC 29483
866.356.1992 Toll Free
info@eccotemp.com
www.eccotemp.com

With Installation Instructions for the Installer

74,500 BTU Max Input



USE & CARE MANUAL

RESIDENTIAL INDOOR GAS
TANKLESS WATER HEATER

FVI12

Replacement Parts.

For models using natural or LP gas.

⚠ WARNING: For your safety, **DO NOT** attempt to disassemble this unit for any reason.

Instructions For Placing a Parts Order

Address parts orders to the distributor or store from where the water heater was purchased.

All parts orders should include:

- The model and serial number of the water heater from the rating plate.
- Specify type of gas (natural or LP) as marked on the rating plate.

- Part description (as noted below) and number of parts desired.

⚠ CAUTION: For your safety, **DO NOT** attempt repair of electrical wiring, gas piping, burners, or other safety devices. Refer repairs to qualified service personnel.

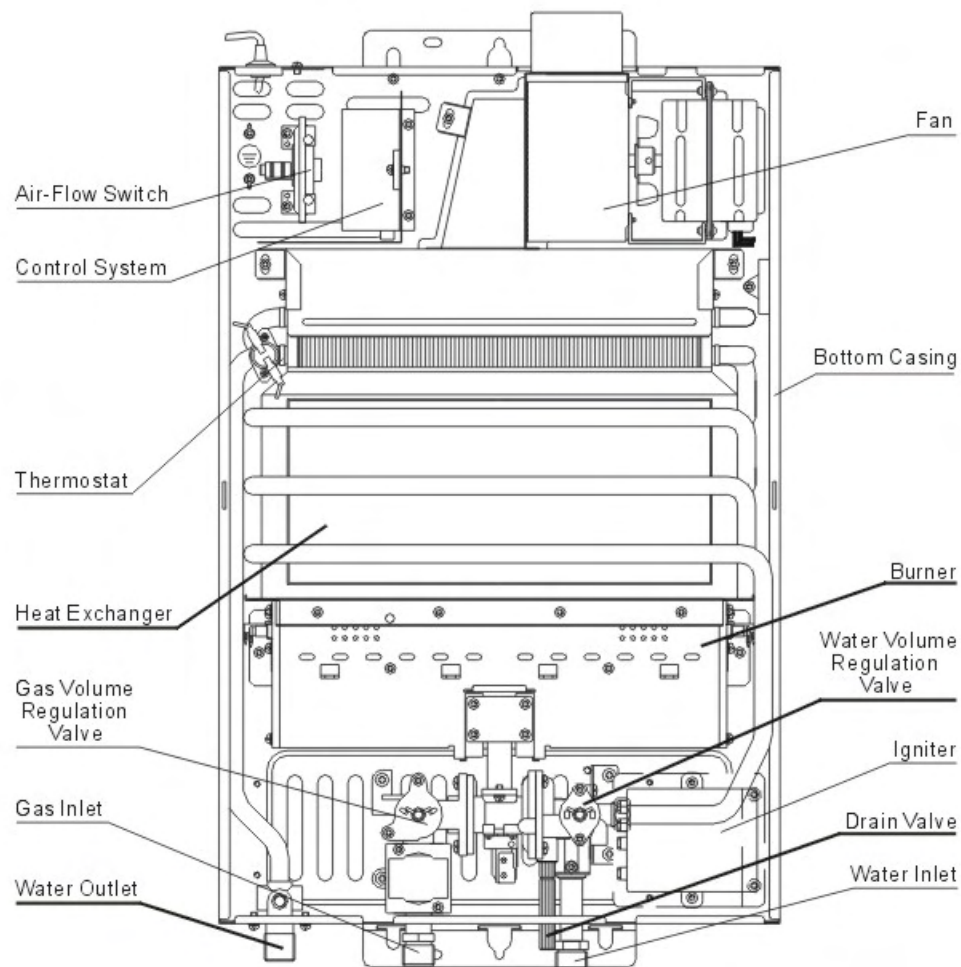

Use & Care Manual

With Installation Instructions for the Installer

Residential Indoor Gas

74,500 BTU Max Input

Tankless Water Heater

⚠ Warning: This water heater is not suitable for use in manufactured (mobile) homes!



The purpose of this manual is twofold: one, to provide the installer with the basic directions and recommendations for the proper installation and adjustment of the water heater; and two, to the owner/operator, to explain the features, operation, safety precautions, maintenance and troubleshooting of the water heater. This manual also includes a parts list.

It is imperative that all persons who are expected to install, operate or adjust this water heater read the instructions carefully so they may understand how to perform these operations. If you don't understand these instructions or any terms within it, seek professional advice.

Any questions regarding the operation, maintenance, service or warranty of this water heater should be directed to the seller from whom it was purchased. If additional information is required, refer to the section on If You Need Service.

Do not destroy this manual. Please read carefully and keep in a safe place for future reference.

⚠ Recognize this symbol as an indication of Important Safety Information!

⚠ California Proposition 65 Warning: This product contains chemicals known to the State of California to cause cancer, birth defects or other reproductive harm.

⚠ WARNING: If the information in these instructions is not followed exactly, a fire or explosion may result causing property damage, personal injury or death.

⚠ FOR YOUR SAFETY!

—Do not store or use gasoline or other flammable vapors or liquids or other combustible materials in the vicinity of this or any other appliance. To do so may result in an explosion or fire.

- Immediately call your gas supplier from a neighbor's phone. Follow the gas supplier's instructions.
- If you cannot reach your gas supplier, call the fire department.
- Do not return to your home until authorized by the gas supplier or fire department.

—WHAT TO DO IF YOU SMELL GAS

- Do not try to light any appliance.
- Do not touch any electrical switch; do not use any phone in your building.

—Improper installation, adjustment, alteration, service or maintenance can cause property damage, personal injury, or death. Refer to this manual. Installation and service must be performed by a qualified installer, service agency or the gas supplier.

Safety Information

Safety Precautions 3-6

LP Gas Models 5

Installation Instructions

Location 7

Water Connections 9-10

Gas Supply 11,12

High Altitude 12

Venting 13,15

Electrical Connection 16

Typical Installation 17

Pipe Insulation 18

Installation Checklist 19

Operating Instructions

Lighting Instructions 20

Water Temperature 21, 22

Care and Cleaning

Maintenance 23

Housekeeping 23, 24

Vent Inspection 24

Burner Inspection 24

Extended Shut-Down 24

Draining 25

Troubleshooting Tips

Before You Call 26

For Service 26,27

Customer Service

Parts List 28



FOR YOUR RECORDS

Write the model and serial numbers here:

You can find them on a label on the appliance.
Staple sales slip or cancelled check here.

Proof of the original purchase date is needed to obtain service under the warranty.



READ THIS MANUAL

Inside you will find many helpful hints on how to use and maintain your water heater properly. A little preventive care on your part can save you time and money over the life of your water heater.

You'll find many answers to common problems in the Troubleshooting Guide. If you review the chart of Troubleshooting Tips first, you may not need to call for service.



READ THE SAFETY INFORMATION

Your safety and the safety of others are very important. There are many important safety messages in this manual and on your appliance. Always read and obey all safety messages.



This is the safety alert symbol. Recognize this symbol as an indication of Important Safety Information!

This symbol alerts you to potential hazards that can kill or hurt you and others.

All safety messages will follow the safety alert symbol and either the word "DANGER", "WARNING", "CAUTION" or "NOTICE".

These words mean:

DANGER An imminently hazardous situation that will result in death or serious injury.

WARNING A potentially hazardous situation that could result in death or serious injury and/or damage to property.

CAUTION A potentially hazardous situation that may result in minor or moderate injury.

Notice: Attention is called to observe a specified procedure or maintain a specific condition.

Error Code Guide

When an error code is displayed:

- Close the hot water faucet, turn off the switch on the control panel.
- Wait for about 5 minutes before turning the switch on again.
- Open the hot water faucet.
- Close the hot water faucet and turn off the switch on the control panel.
- Take the proper action shown below and attempt operation of the appliance again.

If the error code is still shown:

- Turn off the hot water faucet and turn off the switch on the control panel.
- Take note of the error code displayed and call the customer service assistance number in the "If You Need Service" section of the manual on the back cover.

Notice: If an error code other than those listed below is displayed, immediately turn off the hot water faucet, take note of the error code, unplug the water heater and call the customer service number.

Error Code	Error Description	Possible Cause	What To Do
E0	Automatic Power shut-off	Power Goes Off when using heater	Close water faucet then open again
B1	Error from Flame Circuit	Failure to detect the flame	Check if gas off/empty tank Check if the flame sensor damaged
E2	Gas Leak	Flame sensed before opening the main valve	CALL SERVICE
E3	Error from Gas Feed or Ignition Failure	Failure of ignitor or blockage of gas feedline	Check ignitor, temperature control Check gas supply line, Tank level
E4	Temperature Sensor Error	Loose wire, damaged sensor	Check if the sensor damaged or loose
E5	Over Temperature (over 175F)	Water temperature exceeds limits	Water flow is too low or line blockage
E6	Open Circuit Combustion Air pressure Switch	Motor fan senses an open circuit of air pressure switch	Check if the switch or fan is damaged or loose
E7	Short Circuit Air pressure Switch	Motor fan detects a short circuit in air pressure switch	Check if the switch is damaged or loose

In all cases an error code should be referred to Customer Service. 866-356-1992

****GAS SYSTEM REPAIRS SHOULD NOT BE ATTEMPTED, CONSULT PROFESSIONAL OR CALL SERVICE**

CAUTION: For your safety DO NOT attempt repair of gas piping, burners, vent connectors or other safety devices. Refer repairs to qualified service personnel.

CAUTION: Make certain power to water heater is "OFF" before removing protective cover FOR ANY REASON.

CAUTION: Label all wires prior to disconnection when servicing controls. Wiring errors can cause improper and dangerous operation. VERIFY PROPER OPERATION AFTER SERVICING.

Before You Call For Service



Troubleshooting Tips

Save time and money! Review the charts on the following pages first and you may not need to call for service.

This water heater incorporates a combustion shut off device that shuts the operation of the water heater down if undesirable combustion conditions occur. Such as the presence of a blockage of the combustion air inlet vent. Please contact a Qualified Service Technician if this occurs.

Problem	Possible Cause	What To Do
Not enough or no hot water	Water shutoff valve is not fully opened.	Check shutoff valve and open fully.
	Hot water faucet is not fully opened	Open hot water faucet completely. (The main burner goes off when incoming water volume is inadequate.)
	Water piping is frozen.	Allow piping to thaw
	No electricity or water supply is cut off.	Check that proper power is being supplied and/or water supply is adequate.
	Unit is not "ON".	Ensure that the 110v plug is plugged in and there is power going to that receptacle.
	The temperature may be set too low	Increase the temperature setting.
	Mixing Valve malfunction (if applicable).	Check and replace if necessary.
Water not hot enough.	Error code displayed on control panel	See instructions for Error Code and if required, contact a dealer for service.
	The temperature may be set too low.	Increase the temperature setting.
Water too hot	The gas valve is not fully opened.	Check and open the gas valve fully.
	The temperature is set too high	Decrease the temperature setting.
Water too hot	Water shutoff valve is not fully opened.	Check shutoff valve and open fully.
	Small amount of water has been heated	Allow more water to flow.
	Water filter is clogged	Clean the filter with a tooth brush.
Fan continues to rotate after hot water faucet is closed.	This function is to supply hot water when the hot water faucet is reopened.	Normal operation. There is no need to call for service.

CAUTION: Make certain power to water heater is "OFF" before removing protective cover FOR ANY REASON.

CAUTION: Label all wires prior to disconnection when servicing controls. Wiring errors can cause improper and dangerous operation. VERIFY PROPER OPERATION AFTER SERVICING.

CAUTION: For your safety DO NOT attempt repair of electrical wiring, gas piping, burners, vent connectors or other safety devices. Refer repairs to qualified service personnel.

IMPORTANT SAFETY INFORMATION. READ ALL INSTRUCTIONS BEFORE USING.

Be sure to read and understand the entire Use and Care Manual before attempting to install or operate this water heater. It may save you time and money. Pay particular attention to the Safety Instructions. Failure to follow these warnings could result in serious bodily injury or death. Should you have problems understanding the instructions in this manual, or have any questions, STOP, and get help from a qualified service technician, or the local gas utility.



⚠ DANGER!

INSTALL AND PROPERLY VENT THE WATER HEATER...

Failure to properly install the water heater outdoors as outlined in the Installation Instructions in this manual can result in unsafe operation of the water heater. To avoid the risk of fire, explosion, or asphyxiation from carbon monoxide, never operate this water heater unless it is installed properly and has an adequate air supply for proper operation. Be sure to inspect the flue terminal for proper installation at initial start-up; and at least annually thereafter. Refer to the Care and Cleaning section of this manual for more information regarding flue terminal inspection.



⚠ WARNING!

Gasoline, as well as other flammable materials and liquids (adhesives, solvents, paint thinners etc.), and the vapors they produce are extremely dangerous. DO NOT handle, use or store gasoline or other flammable or combustible materials any where near or in the vicinity of a water heater or any other appliance. Be sure to read and follow the labels on the water heater, as well as the warnings printed in this manual. Failure to do so can result in property damage, bodily injury or death.

⚠ DANGER

⚠ Vapors from flammable liquids will explode and catch fire causing death or severe burns.
Do not use or store flammable products such as gasoline, solvents or adhesives in the same room or area near the water heater.
Keep flammable products:
1. far away from heater,
2. in approved containers,
3. tightly closed and
4. out of children's reach.

Water heater has a main burner flame. The main burner flame:
1. which can come on at any time and
2. will ignite flammable vapors.
Vapors:
1. cannot be seen,
2. are heavier than air,
3. go a long way on the floor and
4. can be carried from other rooms to the main burner flame by air currents.

Installation:
Do not install water heater where flammable products will be stored or used unless the main burner flame is at least 18" above the floor. This will reduce, but not eliminate, the risk of vapors being ignited by the main burner flame.

Read and follow water heater warnings and instructions. If owners manual is missing, contact the retailer or manufacturer.

IMPORTANT SAFETY INFORMATION. READ ALL INSTRUCTIONS BEFORE USING.

! DANGER!

WATER TEMPERATURE SETTING

Safety and energy conservation are factors to be considered when selecting the water temperature setting. Water temperatures above 125°F can cause severe burns or death from scalding. Be sure to read and follow the warnings outlined on the label pictured below.

! DANGER



Water temperature over 125°F can cause severe burns instantly or death from scalds.

Children, disabled and elderly are at highest risk of being scalded.

See instruction manual before setting temperature at water heater.

Feel water before bathing or showering.

Temperature limiting valves are available, see manual.

Time/Temperature Relationship in Scalds

Water Temperature	Time To Produce a Serious Burn
120°F	More than 5 minutes
125°F	1 1/2 to 2 minutes
130°F	About 30 seconds
135°F	About 10 seconds
140°F	Less than 5 seconds
145°F	Less than 3 seconds
150°F	About 1 1/2 seconds
155°F	About 1 second

Table courtesy of Shriners Burn Institute

The chart shown above may be used as a guide in determining the proper water temperature for your home.

! DANGER: Households with small children, disabled, or elderly persons may require a 120°F. Or lower temperature setting to prevent contact with "HOT" water.

Maximum water temperature occurs while burner is on. To find water temperature being delivered, turn on a hot water faucet and place a thermometer in the water stream and read the thermometer.

The temperature of the water at the outlet of the water heater can be regulated by setting the temperature on control panel. The control panel was set at 110°F before it was shipped from the factory.

The illustration to the bottom left illustrates the control panel and how to adjust the water temperature.

Notice: When this water heater is supplying general purpose hot water requirements for use by individuals, a thermostatically controlled mixing valve for reducing point of use water temperature is recommended to reduce the risk of scald injury. Contact a licensed plumber or the local plumbing authority for further information.

Notice: The factory setting allows operating temperatures between 90°F and 140°F.



Care and cleaning of the water heater

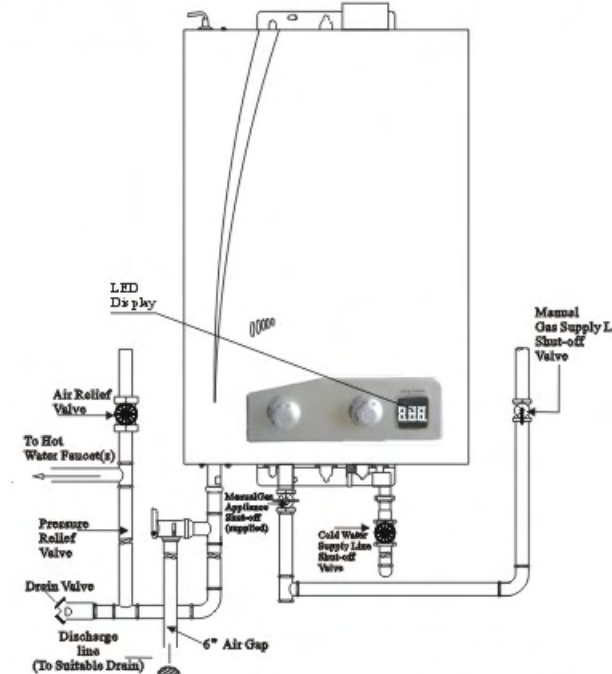

Draining the Water Heater

Below are instructions for draining water out of the water heater.

- Turn off the switch on the remote control.
- Close the gas shut-off valve(s).
- Unplug the power supply cord (or disconnect breaker) at least 10 seconds after step #1.

! WARNING: Failure to follow these instructions while draining the water heater can cause serious damage to the water heater as well as personal injury including scalding.

! WARNING: Failure to drain the water heater can cause serious damage to the water heater as well as personal injury.

NOTICE: DO NOT unplug the electric power supply cord for freeze protection.

Freeze Protection

Where the water heater may be exposed to freezing conditions, even for a short period of time, be sure to drain all water from the unit as instructed above.

Exposure to freezing conditions can occur from down draft of venting system or from installation in areas exposed to cold air.

This device only protects the internal components of the water heater. It does NOT protect piping and valves. Therefore, piping and valves should be wrapped with insulation material as instructed on page 21.

- Open all hot water faucets. Before proceeding to the next step, make sure that COLD water is coming out of all hot water faucets.

- Close the water shut-off valve.

- Using a suitable container to catch water, remove the water filter from heater. Attach a garden hose to the drain valve installed in the hot water outlet line and direct the stream of water to a suitable drain where it will cause no damage. Approximately 21oz of water will be drained. Leave water heater as is until next use.

To put the water heater back into operation after draining, follow the steps below.

- Reinstall the drain plug and water filter. Close the hot water outlet drain valve.

- Open the water shut-off valve and close again after making sure that water comes out from hot water faucets. (This step is to remove air from the water lines.)

- Plug into an electrical outlet, fully open the gas shut-off valve and the water shut-off valve.

NOTICE: The water heater may not operate unless the above procedure is followed correctly.

Another method of freeze prevention is by running a small volume of water. Running water will protect the water heater, piping and valves.

Follow the steps below to ensure proper water flow through the water heater and piping:

- Turn off the switch on the control panel.
- Close the gas shut-off valve.
- Open the hot water faucet slightly until a stream of approximately 1/8" is flowing. Be sure to check the flow periodically.

Care and cleaning of the water heater.

Housekeeping continued

⚠ DANGER: DO NOT attempt to operate the water heater without the air intake filter. DO NOT alter the proving switch to force the unit to operate without the air intake filter.

Notice: The water heater may not work if the air intake filter is severely clogged.

- Make sure the unit is OFF and the electrical power supply has been disconnected.
- Unscrew the holding screw to the right of the filter, and slide the filter down.
- Using a vacuum cleaner, remove any loose dust particles. DO NOT tap the filter as it may deform and/or damage the filter.
- To remove severe dust, use a soft brush and wash with running water.
- Allow the filter to dry completely before reinstalling the filter on the water heater. Be sure to secure the filter by lining the guide tab in the hole and tightening the screw.

CLEANING THE WATER HEATER AND REMOTE CONTROL(S):

- Make sure the unit is OFF and the electrical power supply has been disconnected.
- DO NOT scrub the appliance with a brush.
- Use only mild soapy water, other cleaners may damage the surface of the water heater.
- DO NOT remove any label including the rating plate while cleaning or servicing.
- DO NOT splash water on the remote controls when cleaning.

Venting System Inspection

The venting system should be inspected annually to ensure all of the vent sections are secure and air-tight.

It is recommended that a qualified service personnel familiar with stainless steel vent piping inspect the venting system.

Check vent connection joint sections with a solution of soapy water to assure airtightness while the unit is operating.

Bubbles around a joint connection indicates a seal leak.

DO NOT operate the unit if vent system shows signs of leaking exhaust.

Check to make sure that the Air Intake and the vent terminal have not been blocked or contain debris.

Burner Inspection

Visually inspect the main burners annually.

Through the sight glass, inspect the burner flame with the main burner off and inspect the main burner while firing.

If any unusual burner operation is noted, the water heater should be shut off until qualified service assistance can be obtained.

⚠ CAUTION: For your safety, cleaning of the main burner should be performed only by qualified service personnel.

For cleaning, a vacuum cleaner can be used on the burner.

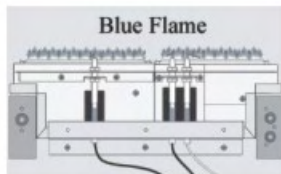

Proper burner pattern.

Vacation and Extended Shut-Down

NOTICE: Refer to the Freeze Protection Section on page 25.

If the water heater is to remain idle for an extended period of time, the power and water to the appliance should be turned off.

The water heater and piping should be drained if they might be subjected to freezing temperatures.

After a long shut-down period, the water heater's operation and controls should be checked by qualified service personnel.

⚠ DANGER!



NATURAL GAS AND LIQUEFIED PETROLEUM MODELS

Both LP and natural gas have an odorant added to aid in detecting a gas leak. Some people may not physically be able to smell or recognize this odorant. If you are unsure or unfamiliar with the smell of LP or natural gas, ask the gas supplier. Other conditions, such as "odorant fade", which causes the odorant to diminish in intensity, can also hide or camouflage a gas leak.

- Water heaters utilizing LP gas are different from natural gas models. A natural gas water heater will not function safely on LP gas and vice versa.
- No attempt should ever be made to convert the water heater from natural gas to LP gas. To avoid possible equipment damage, personal injury or fire, do not connect the water heater to a fuel type not in accordance with the unit data plate; propane for propane units and natural gas for natural gas units. These units are not certified for any other fuel type.
- LP appliances should not be installed below grade (for example, in a basement) if such installation is prohibited by federal, state and/or local laws, rules, regulations or customs.
- Propane or LP gas must be used with great caution. It is heavier than air and will collect first in lower areas making it hard to detect at nose level.
- Before attempting to light the water heater, make sure to look and smell for gas leaks. Use a soapy solution to check all gas fittings and connections. Bubbling at a connection indicates a leak that must be corrected. When smelling to detect a gas leak, be sure to sniff near the floor also.
- Gas detectors are recommended in LP and natural gas applications and their installation should be in accordance with the detector manufacturer's recommendations and/or local laws, rules, regulations or customs.
- It is recommended that more than one method, such as soapy solution, gas detectors, etc., be used to detect leaks in gas applications.

Notice: If a gas leak is present or suspected:

- Do not attempt to find the cause yourself.
- Do not try to light any appliance.
- Do not touch any electrical switch.
- Do not use any phone in your building.
- Leave the house immediately and make sure your family and pets leave also.
- Leave the doors open for ventilation and contact the gas supplier, a qualified service agency or the fire department.
- Stay away from the house (or building) until the service call has been made, the leak is corrected and a qualified agency has determined the area to be safe.

IMPORTANT SAFETY INFORMATION. READ ALL INSTRUCTIONS BEFORE USING

WARNING!

For your safety, the information in this manual must be followed to minimize the risk of fire or explosion, electric shock, or to prevent property damage, personal injury, or loss of life.



FOR INSTALLATIONS IN THE STATE OF CALIFORNIA

California Law requires that residential water heaters must be braced, anchored or strapped to resist falling or horizontal displacement due to earthquake motions. For residential water heaters up to 52 gallon capacity, a brochure with generic earthquake bracing instructions can be obtained from: Office of the State Architect, 400 P Street, Sacramento, CA 95814 or you may call 916-445-8100 or ask a water heater dealer.

However, applicable local codes shall govern installation. For residential water heaters of a capacity greater than 52 gallons or tankless-style, consult the local building jurisdiction code for acceptable bracing procedures.



SAFETY PRECAUTIONS

Have the installer show you the location of the gas shut-off valve and how to shut it off if necessary. Turn off the manual shut-off valve if the water heater has been subjected to overheating, fire, flood, physical damage or if the gas supply fails to shut off.

- Read this manual entirely before installing or operating the water heater.
- Use this appliance only for its intended purpose as described in this Use and Care Manual.
- Be sure your appliance is properly installed in accordance with local codes and the provided installation instructions.
- Part of your water heater unless it is specifically recommended in this manual. All other servicing should be referred to a qualified technician.



READ AND FOLLOW THIS SAFETY INFORMATION CAREFULLY.
SAVE THESE INSTRUCTIONS

Care and cleaning of the water heater.

Routine Preventative Maintenance

Properly maintained, your water heater will provide years of dependable troublefree service.

It is recommended that a periodic inspection of the burner, relief valve, air intake filter, water filter and venting system should be made by service personnel qualified in gas appliance repair.

It is suggested that a routine preventive maintenance program be established and followed by the user.

At least once a year, lift and release the lever handle on the pressure relief valve, located in the hot outlet piping of the water heater, to make certain the valve operates freely. Allow several gallons to flush through the discharge line to an open drain.

NOTICE: If the pressure relief valve on the hot water heater discharges periodically, this may be due to a problem in the water system. Contact the water supplier or your plumbing contractor on how to correct this. DO NOT plug the relief valve outlet.

Rapid closing of faucets or solenoid valves in automatic water using appliances can cause a banging noise heard in a water pipe. Strategically located risers in the water pipe system or water hammer arresting devices can be used to minimize the problem.

▲ DANGER: Before manually operating the relief valve, make certain no one will be exposed to the danger of the hot water released by the valve. The water may be hot enough to create a scald hazard. The water should be released into a suitable drain to prevent injury or property damage.

▲ DANGER: Hotter water increases the potential for Hot Water Scalds.

▲ DANGER: Failure to perform the recommended Routine Preventative Maintenance can harm the proper operation of this water heater, which can cause carbon monoxide dangers, excessive hot water temperatures and other potentially hazardous conditions.

▲ DANGER: Shock Hazard Make sure the electrical power to the water heater is off to avoid potential serious injury or damage to components.

▲ DANGER: Combustible materials, such as clothing, cleaning materials, or flammable liquids, etc., must not be placed against or next to the water heater.

Housekeeping

Before performing Housekeeping tasks to this water heater, turn the unit off and disconnect the power supply.

Vacuum around the water heater for dust, dirt and lint on a regular basis.

Clean the water heater and digital display by using a damp soft cloth with a few drops of mild detergent and gently wiping the surfaces of the unit. wipe any remaining moisture with a dry soft cloth.

To ensure sufficient ventilation and combustion air supply, proper clearances must be maintained.

The air intake water filters should be cleaned on a monthly basis.

DO NOT block or obstruct the air intake opening located at the lower left corner of the water heater. A minimum of 12" is required between this combustion air inlet opening and any obstruction.

Inspect the area around the water heater to ensure a safe operating environment. Keep appliance area clear and free from combustible materials, gasoline, and other flammable vapors and liquids.

Ensure the unit has not been damaged. If damage or denting is present, contact a service personnel to verify proper operation.

Check for any abnormal sounds during normal operation of the water heater.

All piping should be checked for gas and/or water leaks. Refer to page 11 of this manual for instructions on leak testing.

The air intake and cold water supply filters should be cleaned monthly. Refer to the "Housekeeping" section for further information.

DO NOT operate the water heater if you feel something is wrong with the unit.

DO NOT allow children to operate or otherwise handle the unit.

Notice: After inspection, maintenance, and/or cleaning, ensure proper operation by turning on a hot water faucet.

HOW TO CLEAN THE WATER FILTER:

- Make sure the unit is OFF and the electrical power supply has been disconnected.
- Turn the water supply OFF to the heater.
- Unscrew the water filter, and slide the filter out.
- **DO NOT** tap the filter as it may deform and/or damage the filter.
- To remove severe dust, use a soft brush and wash with running water.
- Return the filter to the water heater and screw in the filter.
- Turn the electrical power supply and cold water supply ON to the water heater.

Water Temperature Setting...

Maximum water temperature occurs while the burner is on. To determine the water temperature, turn on a hot water faucet and place a thermometer in the water stream. Water temperature at the faucet may vary depending on season and length of pipe from the water heater.

You adjust the temperature of the water by adjusting the water and gas regulator knobs. Start with the gas turned all the way to its minimum setting and the water turned all the way to its maximum setting. To increase the temperature of the water, increase the amount of gas by turning the gas regulator knob clockwise. There will be a slight delay in the temperature reading on the digital display. If you reach the maximum gas regulator setting and still need to increase the temperature of the water, start to turn the water regulator knob down by turning it clockwise. Again, there is a slight delay in the temperature change.

The hottest temperature water will be at the hot water faucet closest to the water heater.

Always remember to test the water temperature with your hand before use and remember that hotter water increases the risk of scald injury.

Always supervise young children or others who are incapacitated.

The water heater is equipped with a device that will shut off the gas supply to the burner if the water heater exceeds normal operating temperatures. Refer to the (Before You Call For Service) section located near the back of this manual, or contact your dealer.

⚠ WARNING: Should overheating occur or the gas supply fail to shut off, turn off the manual gas control valve to the appliance.

If the water heater has been subjected to fire, flood or physical damage, turn off the manual gas shut-off valve(s), and do not operate the water heater again until it has been checked by qualified personnel.

Notice: The water heater may not operate with a small water flow. In such case, increase the water flow. If water heater still does not operate and hot water faucet is completely open, increase the temperature setting on the control panel.



LED Display
(Display water temperature and error codes)

Installing the water heater.

This water heater must be installed in accordance with these instructions, local codes, utility company requirements, and/or in the absence of local codes, use the latest edition of the American National Standard/National Fuel Gas Code. A copy can be purchased from either the American Gas Association, 400 North Capitol Street Northwest, Washington, DC 20001 as ANSI standard Z223.1 or National Fire Protection Association, 1 Batterymarch Park, Quincy, MA 02269 as NFPA 54. In Canada, the latest edition of the CSA B149.1 Natural Gas and Propane Installation, and the Canadian Electrical Code, CSA C22.1 Part 1, in the absence of local codes.

Indoor Location

The water heater should not be located in an area where leakage of the heat exchanger or connections will result in damage to the area adjacent to it or to lower floors of the structure.

When such areas cannot be avoided it is recommended that a suitable catch pan, adequately drained, must be installed under the water heater.

The pan must not restrict combustion air flow.

A gas fired water heater or any other appliance should not be installed in a space where liquids which give off flammable vapors are to be used or stored. Such liquids include gasoline, LP gas (butane or propane), paint or adhesives and their thinners, solvents or removers.

Because of natural air movement in a room or other enclosed space, flammable vapors can be carried some distance from where their liquids are being used or stored. The open flame of the water heater's main burner can ignite these vapors causing an explosion or fire which may result in severe burns, death or property damage.

The water heater must be located so it is not subject to physical damage, for example, by moving vehicles, area flooding, etc.

If the water heater is installed in a garage, it should be installed so that the direct ignition system and main burner are no less than 18 inches above the garage floor.

Raising the gas fired water heater will reduce BUT NOT eliminate the possibility of lighting the vapor of any flammable liquids which may be improperly stored or accidentally spilled.

⚠ WARNING: Combustible construction refers to adjacent walls and ceilings and should not be confused with combustible or flammable products and materials. Combustible and/or flammable products and materials should never be stored in the vicinity of this or any gas appliance.

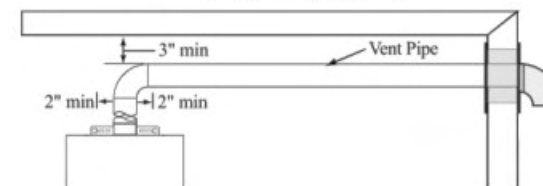
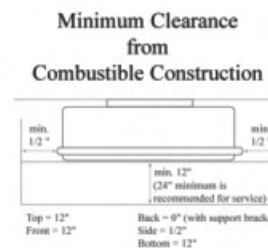

- The water heater should be installed as close as practical to the vent termination to minimize vent length and the number of elbows required for venting.
- The water heater should be installed with the proper venting materials and termination suitable for appropriate venting.
- Failure to install and properly venting the water heater to the outdoors as outlined in the Venting Section of this manual can result in unsafe operation.
- Long hot water lines should be insulated to conserve water and energy.
- The water heater and water lines should be protected from exposure to freezing temperatures.
- Do not install the water heater in bathrooms, bedrooms, any occupied rooms normally kept closed, or in outdoor areas.
- Do not install the water heater in small, poorly ventilated rooms, or in air tight rooms with air-conditioning.
- Do not install water heater where subject to vibrations.
- Do not install the water heater in Recreational Vehicles, Mobile Homes, Boats and other Watercrafts.
- Do not install the water heater near vents for heating or cooling. A minimum of 4 feet should be maintained.
- Minimum clearance from combustible construction is 1/2" sides, 0" rear (with support bracket); 12" from the bottom; 12" from the front of the water heater; and 12" from the top (24" from front and top is recommended for servicing purposes). If the clearances stated on the Instruction/Warning Label, located on the front panel of the heater differ, install the water heater according to the clearances stated on the label.

Installing the water heater.

Proper operation of the water heater requires air for combustion and ventilation. Provisions for combustion and ventilation air must comply with referenced codes and standards.

Combustion and Ventilation Air

NOTICE: If the water heater is installed in an unconfined space within a building of conventional frame, masonry or metal construction, infiltration air is normally adequate for proper combustion and ventilation. If the water heater is installed in a confined space, provisions for combustion and ventilation air must be made.

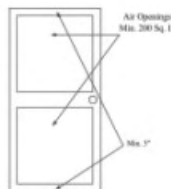

A confined space is one having a volume of less than 50 cubic feet per 1000 Btuh of the aggregate input of all appliances within that space.

The air must be supplied through two permanent openings of equal area. One is to be located within 12" above the floor and the other is to be located within 12" below the ceiling.

The minimum net free area of each opening must not be less than one square inch per 1000 Btuh of the total input rating of all the appliances in the enclosure (but not less than 100 square inches), if each opening communicates with other unconfined areas inside the building.

Buildings of unusually tight construction shall have the combustion and ventilation air supplied from outdoors, or a freely ventilated attic or crawl space.

If air is supplied from outdoors, directly or through vertical ducts, there must be two openings located as specified above and each must have a minimum net free area of not less than one square inch per 4000 Btuh of the total input rating of all the appliances in the enclosure.

If horizontal ducts are used to communicate with the outdoors, each opening must have a minimum net free area of not less than one square inch per 2000 Btuh of the total input rating of all the appliances in the enclosure. If ducts are used, the minimum dimensions of rectangular air ducts shall not be less than 3".

NOTICE: If the duct openings which supply combustion and ventilation air are to be covered with a protective screen or grill, the net free area (openings in the material) of the covering material must be used in determining the size of the openings. Protective screening for the openings **MUST NOT** be smaller than 1/4" mesh to prevent clogging by lint or other debris.

Corrosive Atmospheres

NOTICE: The water heater should not be installed near an air supply containing halogenated hydrocarbons.

The air in beauty shops, dry cleaning establishments, photo processing labs, and storage areas for liquid and powdered bleaches or swimming pool chemicals often contain such halogenated hydrocarbons.

An air supply containing halogenated hydrocarbons may be safe to breathe, but when it passes through a gas flame corrosive elements are released that will shorten the life of any gas burning appliance.

Propellants from common spray cans or gas leaks from A/C and refrigeration equipment are highly corrosive after passing through a flame.

The water heater warranty is voided when failure of the heater is due to operation in a corrosive atmosphere.

Inspect Shipment

Inspect the water heater for possible damage. Check the markings on the rating plate of the water heater to be certain the type of gas supplied corresponds to the water heater requirements. Verify all included parts are present (see below).



Wood Screw x 4pcs



Washer x 4pcs



Exposure screw 2pcs



Use & Care Manual

Operating the water heater.

Safety Precautions

- Do not turn off manual gas shut-off valve if water heater has been subjected to over heating, fire, flood, physical damage or if the gas supply fails to shut off.
- Do Not store or use gasoline or other flammable vapors and liquids, such as adhesives or paint thinner, in vicinity of this or any other appliance. If such flammables must be used, open doors and windows for ventilation, and all gas burning appliances in the vicinity should be shut off including their pilot lights, to avoid vapors lighting.
- Do Not turn on water heater unless water and gas supplies are fully opened.
- Do Not turn on water heater if cold water supply shut-off valve is closed.
- Do Not allow combustible materials such as newspaper, rags or mops to accumulate near water heater.

NOTICE: Flammable vapors can be drawn by air currents from surrounding areas to the water heater.

If there is any difficulty in understanding or following the Operating Instructions or the Care and Cleaning section, it is recommended that a qualified person or serviceman perform the work.

Water Temperature Setting

The temperature of the water in the water heater can be regulated by setting the temperature on the front of the control panel.

▲ DANGER: There is a hot water scald potential if the temperature is set too high. Households with small children, disabled, or elderly persons may require a 120°F or lower temperature setting to prevent contact with HOT water.

Safety factors should be considered when selecting the water temperature setting of the water heater's control panel.

The control panel was set at 110°F before the water heater was shipped from the factory. This is the recommended starting point.

Water temperatures above 125°F can cause severe burns or death from scalding.

Be sure to read and follow the warnings outlined in this manual and on the label located on the water heater.

Mixing valves are available for reducing point of use water temperature by mixing hot and cold water in branch water lines.

Contact a licensed plumber or the local plumbing authority for further information.

The chart below may be used as a guide in determining the proper water temperature for your home.

Time/Temperature Relationship in Scalds

Water Temperature	Time To Produce a Serious Burn
120°F	More than 5 minutes
125°F	1 1/2 to 2 minutes
130°F	About 30 seconds
135°F	About 10 seconds
140°F	Less than 5 seconds
145°F	Less than 3 seconds
150°F	About 1 1/2 seconds
155°F	About 1 second

Table courtesy of Shriners Burn Institute

Lighting the water heater.



Before operating this water heater, be sure to read and follow the instructions on the label pictured below and all other labels on the water heater, as well as the warnings printed in this manual. Failure to do so can result in unsafe operation of the water heater resulting in property damage, personal injury, or death. Should you have any problems reading or following the instructions in this manual, STOP, and get help from a qualified person.

BEFORE USING THE WATER HEATER

WARNING : If you do not follow these instructions exactly, a fire or explosion may result causing property damage, personal injury or loss of life.

- A. This appliance does not have a pilot. It is equipped with an ignition device which automatically lights the burner. Do not try to light the burner by hand.
- B. BEFORE OPERATING smell all around the appliance area for gas. Be sure to smell next to the floor because some gas is heavier than air and will settle on the floor.
- WHAT TO DO IF YOU SMELL GAS**
- Do not try to light any appliance.
 - Do not touch any electric switch; do not use any phone in your building.
 - Immediately call your gas supplier from a neighbor's phone. Follow the gas supplier's instructions.
 - If you cannot reach your gas supplier, call the fire department.
 - Do not return to your home until authorized by the gas supplier or fire department.
- C. Use only your hand to push in or turn the gas control knob. Never use tools. If the knob will not push in or turn by hand, don't try to repair it, call a qualified service technician. Force or attempted repair may result in a fire or explosion.
- D. Do not use this appliance if any part has been under water. Immediately call a qualified service technician to inspect the appliance and to replace any part of the control system and any gas control which has been under water.

OPERATING INSTRUCTIONS

1. STOP! Read the safety information above on this label.
2. Turn off all electric power to the appliance.
3. Do not attempt to light the burner by hand.
4. Turn the Gas Shutoff Valve located on the outside of the unit clockwise  to the "OFF" position.
5. Wait five (5) minutes to clear out any gas. If you then smell gas, STOP! Follow "B" in the safety information above on this label. If you don't smell gas, go to the next step.
6. Turn the Gas Shutoff Valve located on the outside of the unit counterclockwise  to the "ON" position.
7. Turn on all electric power to the appliance.
8. If the appliance will not operate, follow the instructions "To Turn Off Gas To Appliance" and call your service technician or gas supplier.

GAS SHUTOFF VALVE



TO TURN OFF GAS TO APPLIANCE

1. Turn off all electric power to the appliance if service is to be performed.
2. Turn the Gas Shutoff Valve located on the outside of the unit clockwise  to the "OFF" position.

Mounting the Water Heater

Make sure the location of the appliance allows for easy access and operation.

Wall studs should be utilized when mounting the water heater to the wall. In case of dry wall or concrete wall use dry wall anchors or lag bolts.

The water heater requires 120VAC/60Hz. Have a receptacle with ground terminal near the water heater. The length of the power supply cord is 10 feet.

Install a wood screw for the upper bracket with a clearance of 1/8" between the wall and the screw head. Hang the center of the upper bracket on the screw.

Using a wood screw and a washer, affix the lower bracket to the wall (Left and Right). Repeat to affix the top bracket.

CAUTION: Reinforcement of the wall is required in case the wall is not strong enough to hold the appliance.

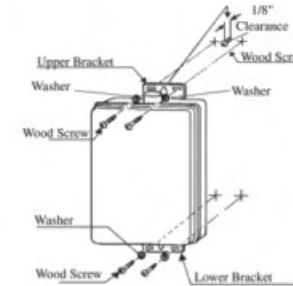

The brackets can be adjusted to change the distance between the back of the appliance and the wall within the range of 3/8" to 1 (1/2)

Loosen the adjustment screws of both the top and the bottom brackets to adjust the distance. (See diagram below)

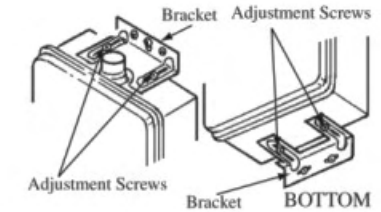

IMPORTANT: Do not apply heat to the HOT or COLD water connections. If sweat connections are used, sweat tubing to adapter before fitting adapter to the water connections on heater. Any heat applied to the water supply fittings will permanently damage the internal components of the water heater.

CAUTION: This water heater must only be used with the following water supply system conditions:

- With clean, potable water free of corrosive chemicals, sand, dirt, or other contaminants.
- With inlet water temperatures above 32°F, but not exceeding 120°F.
- Free of lime and scale deposits.
- DO NOT reverse the hot and cold water connections. The water heater will not operate.

Water Supply Connections

Plumbing should be carried out by a qualified plumber in accordance with local codes.

Use approved plumbing materials only.

All material between the water supply and the water heater must be metal.

The diameter of the water supply pipe lines should be a minimum of 1/2"

To conserve energy and to prevent freezing, insulate both cold and hot water supply lines. DO NOT cover the drain valves.

To ensure proper operation of the water heater, the following water pressure guidelines should be followed:

- Operation of the water heater requires the minimum water pressure of 4.5 psi and a minimum water flow rate of 0.93 gpm.
- Additional water pressure is required for long pipe runs and outlet fitting(s) water pressure drops.
- To maintain proper performance, ensure sufficient water supply pressure. The Required Water Pressure = Min. Operating Water Pressure (14 psi) + Pipe Pressure Loss + Faucet and Shower Pressure Loss + Safety Margin (more than 5 psi).

● To supply hot water to upper floors, additional water pressure (0.44 psi/ft) must be ensured. The measurement should be calculated by the distance between the water inlet of the water heater (ground level) to the hot water faucet (upper floor level).

● Well water systems should be set at a range of 50-60 psi.

● When the water is supplied from a water supply tank, the height of the tank and the diameter of the pipes and their relation to water pressure, should be taken into consideration. **Gravity water pressure is not recommended.**

Notice: If the water flow resistance of a shower head is too high, the burner in the water heater will fail to ignite. Keep the shower head clean from debris that could cause additional pressure drop.

Notice: If using mixing valves on the outlet, choose one which prevents cold water pressure from overcoming hot water line pressure.

Installing the water heater.

Water Supply Connections Continued.

Install a shutoff valve near the inlet of the water heater for service and draining purposes.

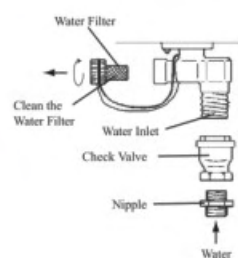

DO NOT use pipes with smaller diameters than the water supply connection of the water heater.

Before connecting the water supply pipe to the water heater, open the shutoff valve and clean out sand, debris, air, caulking material, etc. inside the pipe. Connect to the water inlet, then check water flow.

Close the shutoff valve and clean the water filter.

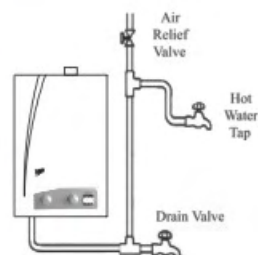

Be sure to connect the water inlet and the hot water outlet as shown on the water heater. If reversed, the water heater will not function.

Installation of unions or flexible copper connections are recommended on the HOT and COLD water lines, so that the water heater may disconnect easily for servicing if necessary.

A check valve may be required between heater and water shutoff. Check with local codes.

The following should be addressed in regards to the HOT WATER OUTLET:

- Connections between the water heater and point(s) of use should be as short and direct as possible.
- DO NOT use lead or plastic pipe.
- To conserve energy and minimize heat loss, insulation of hot water piping is recommended.

Notice: The flow rate of hot water may vary when more than two faucets (appliances, fixtures, etc.) are being used simultaneously.

Notice: The pipes MUST be completely drainable. If the hot water faucets are located at a point higher than the water heater, place a drain valve at the lowest point (see diagram to the left).

Relief Valve

A new pressure relief valve, complying with the Standard for Relief Valves and Automatic Gas Shut-Off Devices for Hot Water Supply Systems, ANSI Z21.22, may be needed to be installed at the hot water connection of the water heater at the time of installation. Check with local code(s) that govern the installation of relief valves and other applicable measures.

For safe operation of the water heater, be sure that:

- The pressure rating of the relief valve must not exceed 150 psi, the maximum working pressure of the water heater as marked on the rating plate.
- The BTUH rating of the relief valve must equal or exceed the BTUH input of the water heater as marked on its rating plate.
- No valve of any type should be installed between the relief valve and the water heater
- Discharge from the relief valve should be piped to a suitable drain to eliminate potential water damage. Piping used should be of a type approved for the distribution of hot water.
- Hot and cold water lines should be insulated up to the water heater. Refer

- The discharge line must be NO SMALLER than the outlet of the valve and must pitch downward to allow complete drainage (by gravity) of the relief valve and discharge line.
- The end of the discharge line should not be threaded or concealed and should be protected from freezing. No valve of any type, restriction or reducer coupling should be installed in the discharge line.

Notice: Local codes govern the installation of relief valves. If local codes require that a temperature and pressure relief valve should be installed the manufacturer recommends a type 40XL Watts T&P relief valve or an equivalent model be used.

Notice: Manual operation of relief valves should be performed at least once a year. Turn off the electrical power and gas shutoff valve. Lift and release lever on the relief valve and check the manual operation of the relief valve. You should take precaution to avoid contact with the hot water coming out of the relief valve and to prevent water damage.

Notice: If the relief valve on the system discharges periodically, a problem exists and service to the water system is required.

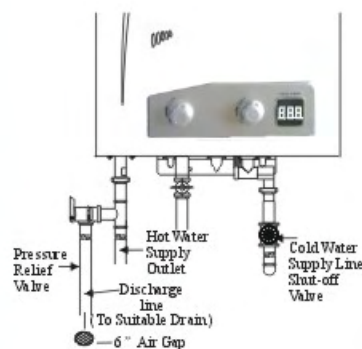

Notice: The above illustrates a pressure only relief valve. If local codes require a combination temperature and pressure relief valve be installed, an extension piece may be needed.

Installing the water heater

Installation Check List

A Water Heater Location

- Close to area of vent termination.
- Indoors and protected from freezing temperatures.
- Proper clearance from combustible surfaces observed.
- Sufficient fresh air supply for proper operation of water heater.
- Air supply free of corrosive elements and flammable vapors.
- Provisions made to protect area from water damage.
- Sufficient room to service heater.
- Combustible materials, such as clothing, cleaning materials, rags, etc. clear of the heater and vent piping.
- Water heater is properly attached to the wall.

B. Water Supply

- Water supply has sufficient pressure.
- Air purged from water heater and piping.
- Water connections tight and free of leaks
- Water filter is clean and in place.
- Materials used are as instructed in this manual.
- Water pipes are insulated.

C. Gas Supply

- Gas type matches rating plate.
- Gas supply pressure is sufficient for the water heater.
- Gas line equipped with shut-off valve, union and sediment trap.
- Approved pipe joint compound used.
- Soap and water solution used to check all connections and fittings for possible gas leak.
- Gas Company inspected installation (if required).

D. Relief Valve

- Pressure Relief Valve properly installed and discharge line run to open drain
- Discharge line protected from freezing.

E. Venting

- Materials used are as instructed in the manual.
- Vent connector(s) securely fastened together with high temperature silicone (500°F) and air-tight.
- All vent runs are properly supported.
- Vent terminal is properly installed.
- Sufficient combustion air is available.
- Maximum and minimum vent lengths are observed.

F. Electrical Wiring

- Voltage matches rating plate.
- Water heater is properly grounded.
- Supply cord meets all local codes.

Insulation Blankets

⚠ WARNING: If local codes require external application of insulation blanket kits the manufacturer's instructions included with the kit must be carefully followed.

Insulation blankets, available to the general public, for external use on gas water heaters are not necessary. The purpose of an insulation blanket is to reduce the standby heat loss encountered with storage tank heaters. This water heater does not store water making an insulation blanket unnecessary.

The manufacturer's warranty does not cover any damage or defect caused by installation, attachment or use of any type of energy saving or other unapproved devices (other than those authorized by the manufacturer) into, onto or in conjunction with the water heater.

The use of unauthorized energy saving devices may shorten the life of the water heater and may endanger life and property.

The manufacturer disclaims any responsibility for such loss or injury resulting from the use of such unauthorized devices.

Hot and Cold Pipe Insulation Installation

NOTICE: The hot and cold pipes should be insulated as shown to provide additional freeze protection.

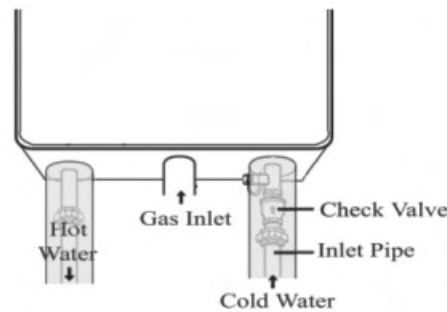

For increased energy efficiency, use pipe insulation. Please install the insulation, according to the illustrations above,

making sure to insulate all the way to the top. **Do not** cover any drain or pressure valve(s).

During Installation of this water heater.....

Do's

- Do check inlet gas pressure to ensure that it is within the range specified on the rating plate.
- Do provide adequate air for combustion and ventilation as discussed in the Use & Care Manual and the National Fuel Gas Code (CAN/CGA B149 in Canada).
- Do maintain proper clearances to combustibles as specified on the nameplate.
- Do ensure that the flue terminal location complies with the guidelines found in the Use & Care Manual and National Fuel Gas Code (CAN/CGA B149 in Canada).
- Do maintain proper clearances to combustibles as specified in this guide or by local requirements.
- Do ensure the exhaust pipe is at a minimum of 5 degree downgrade.
- Do ensure that a trained professional is handling the installation.

Don'ts

- Don't remove the front cover unless absolutely necessary. This should only be done after being examined by a qualified service technician.
- Don't install this product where standing water may occur.
- Don't try to operate the unit without the provided vent pipe properly attached.

⚠ WARNING: Do not attempt to convert this water heater for use with a different type of gas other than the type shown on the rating plate. Such conversion could result in hazardous operating conditions.

Gas Supply

You may need to supply a Manual Gas Appliance Shutoff Valve at the gas connection of the water heater at the time of installation (see diagram to the left).

The branch gas supply line to the water heater should be clean 1/2" black steel pipe or other approved gas piping material.

A ground joint union or ANSI design certified semi-rigid or flexible gas appliance connector should be installed in the gas line close to the water heater. The National Fuel Gas Code (NFGC) mandates a manual gas shut-off valve: See (NFGC) for complete instructions.

If lever type gas shut offs are used, they shall be T-Handle type.

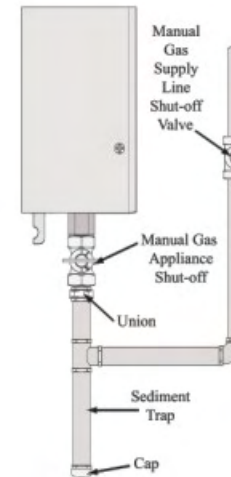

Compound used on the threaded joints of the gas piping must be of the type resistant to the action of LP gas. Use compound sparingly on male threads only.

A sediment trap should be installed at the bottom of the gas line. Do not use excessive force (over 31.5 ft lbs.) in tightening the pipe, particularly if teflon pipe compound is used, as the unit may be damaged.

The inlet gas pressure to the water heater must not exceed 10.5" w.c. for natural or 14" wc for LP gas. For purposes of input adjustment, the minimum inlet gas pressure (with main burner on) is shown on the water heater rating plate. If high or low gas pressures are present, contact your gas supplier for correction.

⚠ WARNING: Never use an open flame to test for gas leaks, as property damage, personal injury, or death could result.

Leak Testing

The water heater and its gas connections must be leak tested at normal operating pressures before it is placed in operation.

- Turn on the gas shut-off valve(s) to the water heater.

- Use a soapy water solution to test for leaks at all connections and fittings. Bubbles indicate a gas leak that must be corrected.

The factory connections should also be leak tested after the water heater is placed in operation.

⚠ WARNING: Install a gas pressure regulator, in the gas supply line, which does not exceed the maximum supply pressure.

DO NOT use an industrial type gas regulator.

Pressure Testing the Gas Supply System

The water heater and its manual gas shutoff valve must be disconnected from the gas supply piping system during any pressure testing of the system at pressures in excess of 1/2 psi (14'w.c.).

The water heater must be isolated from the gas piping system by closing the manual gas shut-off valve during any pressure testing of the gas supply piping at pressures equal to or less than 1/2 psi (14'w.c.).

High Altitude

Ratings of gas appliances are based on sea level operation and need not be changed for installations at elevations up to 3,000 feet.

Not recommended above 3,000 feet (1000 meters).

Installing the water heater.

Typical Installation

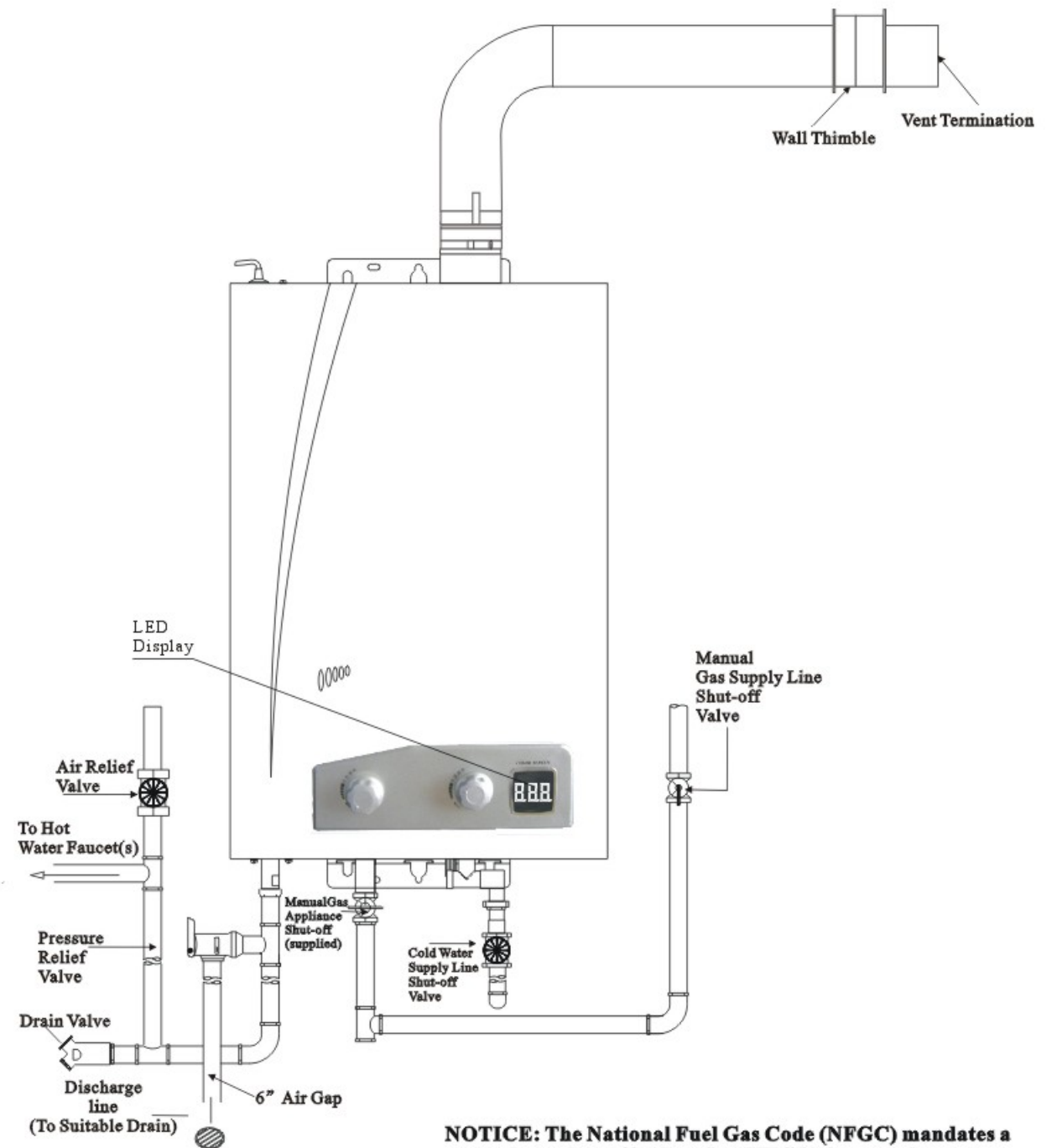

NOTICE: The National Fuel Gas Code (NFGC) mandates a manual gas shut-off valve: See (NFGC) for complete instructions. Local codes or plumbing authority requirements may vary from the instructions or diagrams provided and take precedent over these instructions.

⚠ WARNING: Field wiring connections and electrical grounding must comply with local codes, or in the absence of local codes, with the latest edition of the National Electrical Code, ANSI/NFPA 70, or in Canada, Canadian Electrical Code, CSA C22.1 Part 1.

Electrical Connection

POWER CORD:

- The electric power supply requirement for this water heater is 120 VAC/60HZ, 2 Amps.
- The water heater comes with a three (3) pin power supply cord. Use only a power outlet with a ground terminal.
- The installation of an electric leakage breaker is recommended.
- Keep any excess of the power supply cord on the outside of the water heater.

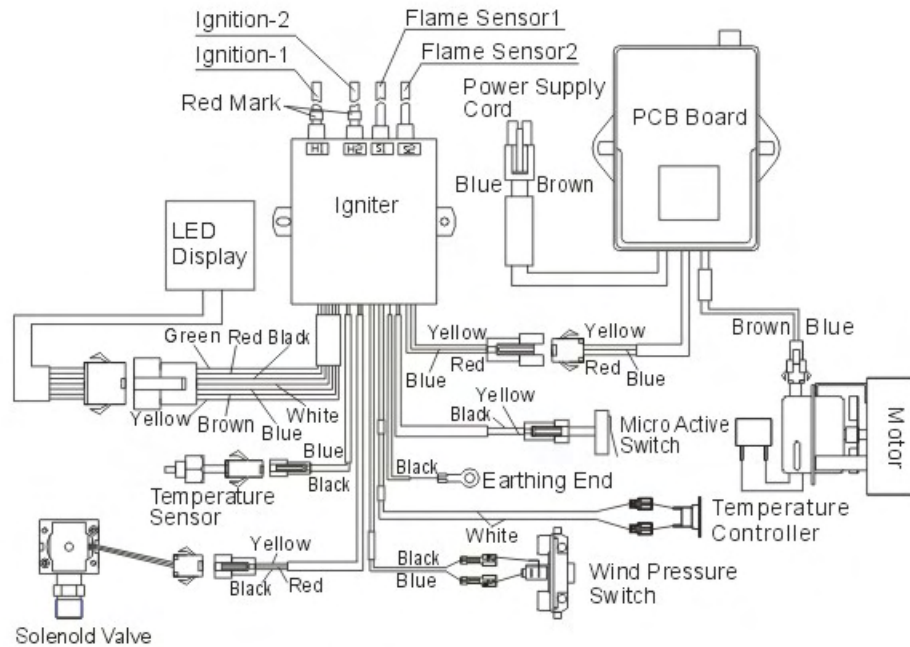

Installing the water heater.

Clearance Requirements from Vent Terminations to Building Openings

* All clearance requirements are in accordance with ANSI Z21.10.3a-2003 and the National Fuel Gas Code, ANSI Z223.1.

	Maintain the following clearances to any opening in any building:	Illustration
Vent Clearances When Heater is Installed Indoors	<ul style="list-style-type: none"> • 4' below, 4' horizontally from, or 1' above any door, operable window, or gravity air inlet into any building. • 3' above any forced air inlet within 10'. 	
Vent Clearances When Heater is Installed Outdoors With a Vent Cap	<ul style="list-style-type: none"> • 1' below, 1' horizontally from, or 1' above any door, operable window, or gravity air inlet into any building. • 3' above any forced air inlet within 10'. 	<p>(vent cap)</p>

* For Installations in Canada, clearances are as follows: To windows, doors, & gravity air inlets: 36". To forced air inlets: 6'. These clearance requirements hold true for all of the above situations: Indoor, Outdoor w/vent cap, & Recess Box.

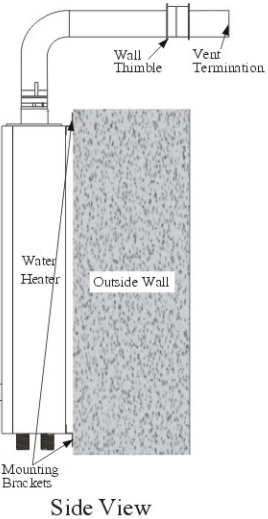
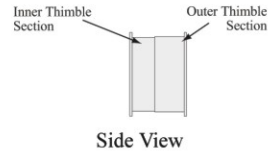

Only the 2" vent kit provided with the FVI-12 should be used for installation.

The Wall Thimble requires mechanical support from the wall sufficient to support any incidental loads on the system. If the wall is not sufficient enough to support the Wall Thimble, then appropriate additional framing and/or blocking is required.

INSTALLATION PROCEDURE:

Prepare an opening for the Wall Thimble in the wall. The opening must be 6-1/2 inches in diameter for a 3 inch vent system. The opening should be round.

The opening must be able to accommodate the 2" vent system and wall thimble provided." Consult manual or building codes for distance from flammable materials.

The Wall Thimble is designed to adapt to any wall thickness from 3-1/2" to 6" thick. If the wall is thicker than 6" the Wall Thimble may be extended using a piece of 6" diameter snaplock or welded seam galvanized pipe up to 6" long.

Select the larger diameter half of the Wall Thimble for the outside of the wall.

- Apply a continuous bead of high quality silicone or silicone/latex caulk on the inside of the outer flange. This will be the only weather seal to keep moisture outside the building. Ensure a sufficient seal is made.
- Position this portion of the Wall Thimble into the prepared hole from the outside. Secure the assembly into the prepared opening using fasteners as indicated by sheathing or structural members, sealing the screw heads with more caulking.

Use 4 hollow wall anchors, at least 1/8" in diameter and of appropriate length for the thickness of the sheathing, if sheathing is particle board or other composite material. Use 4 #10x1-1/4" wood screws for plywood, solid wood sheathing or members. Use suitable masonry anchors when passing through solid masonry walls. Reinstall the decorative sheathing around the Wall Thimble. This assembly may be painted to match the exterior decor.

- Slide the interior portion of the Thimble into the inside hole. Be certain the interior and exterior Thimble halves overlap at least 1". If insufficient overlap exists, extend the interior portion with single wall galvanized pipe.
- Secure the Wall Thimble to the interior sheathing using suitable fasteners.
- Secure the vent section that protrudes through the wall thimble to the 90 degree elbow attached to the water heater.
- The exhaust pipe should be sloped downward at an approximate 5 degree grade in order to avoid rain (or condensation entering the heater) through the exhaust pipe.

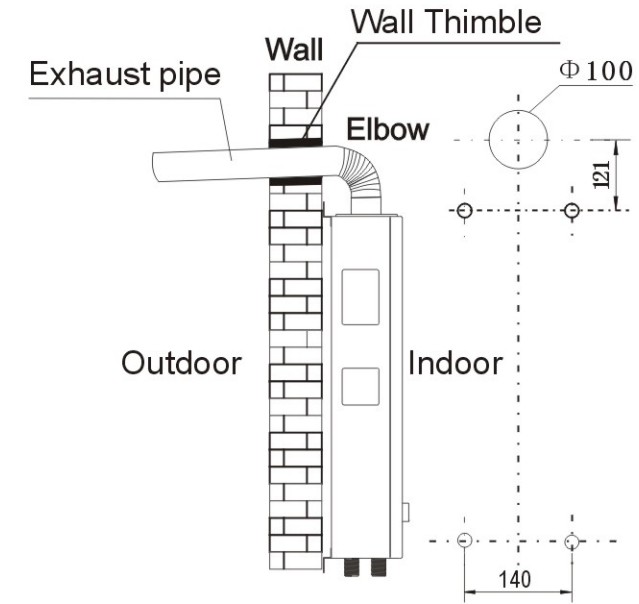

Install method 1

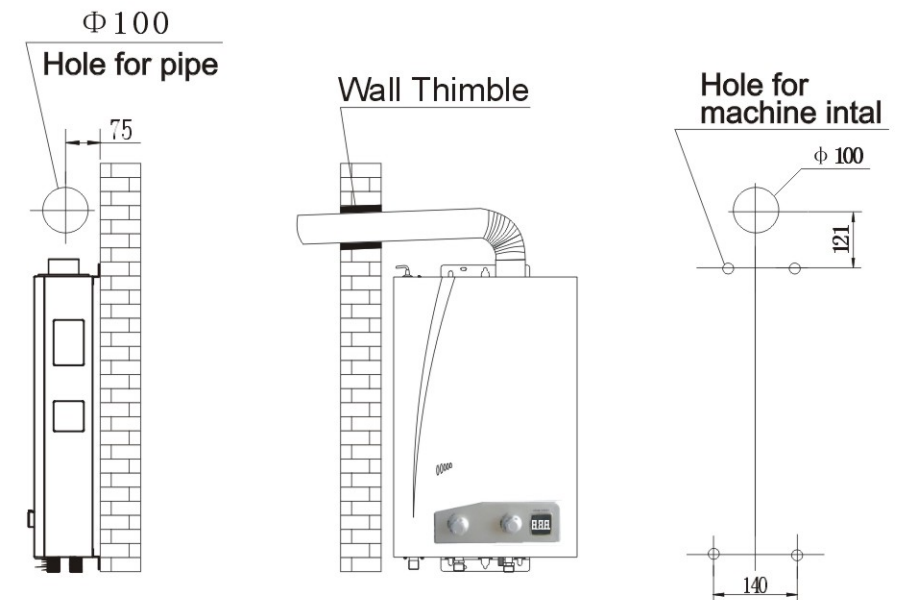

Install method 2