

HONDA VFR 1200F 2010 - 2013 DIY WINDSCREEN INSTALL

Installation Instructions for Honda VFR 1200F 2010 - 2013

Thank you for purchasing Zero Gravity windscreen, which has been designed and manufactured to give years of safe & fun riding. These instructions give you an in-depth look at the installation process. To receive further assistance or parts please e-mail techinfo@zerogravity-racing.com.

PLEASE READ BEFORE MOUNTING YOUR WINDSCREEN

Helpful hints: Use metric tools, clean hands, put the bike on a stand. Do not pry on the screen excessively, as it can break without warning.

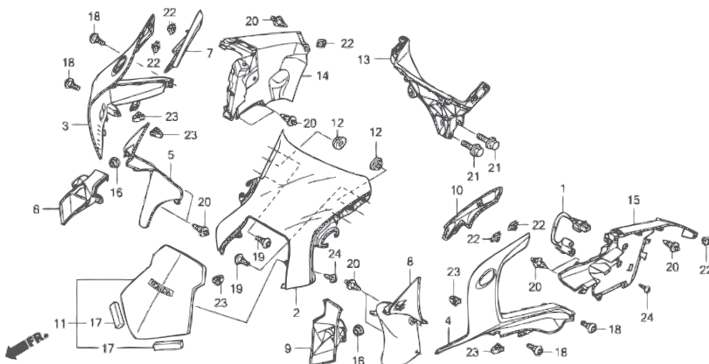

FIG1

Fig 1. Remove both mirrors. Locate both fasteners located on the inside fairing. Also, remove inner plastic that's covering both left & right two allen screws.

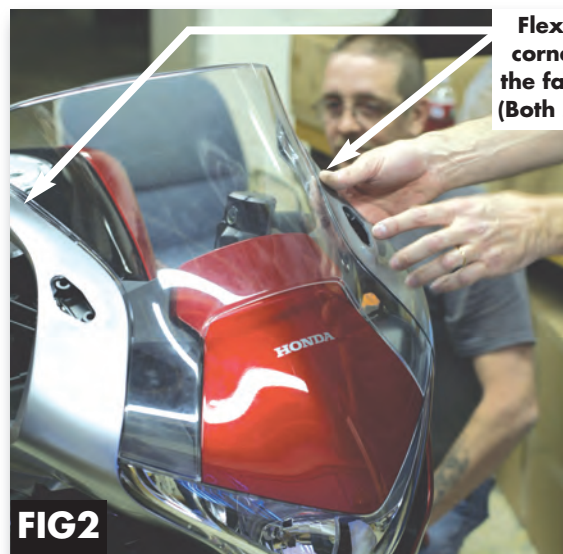

FIG2

Fig 2. After removing the mirrors, flex the corner fairing to expose the next step in unhooking the stock windscreen as shown in **Fig 3**.



FIG2A

Fig 2A. HERE IS THE TRICKY PART! Locate the fairing retention clip and windscreen T-Hooks **before applying any movement pressure**. There will be two T-Hooks, one on each side. (See **FIG3**).

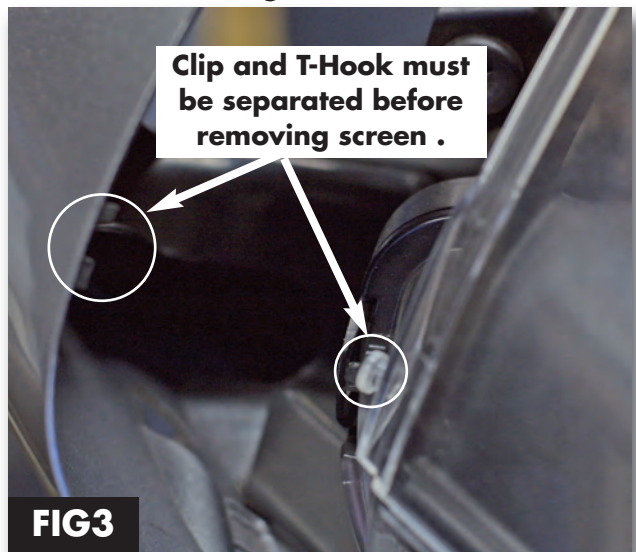

FIG3

Fig 3. Separate T-Hooks from the retention clip by applying a light pressure from the corner fairing and work the light pressure down as shown. (Both Sides) **Be careful not too exert to much force!**

HONDA VFR 1200F 2010 - 2013 DIY WINDSCREEN INSTALL



FIG4. Locate the upper fairing, Lift windscreen away from the mirror mounting standoffs. It should look like this on both sides of the windscreen.

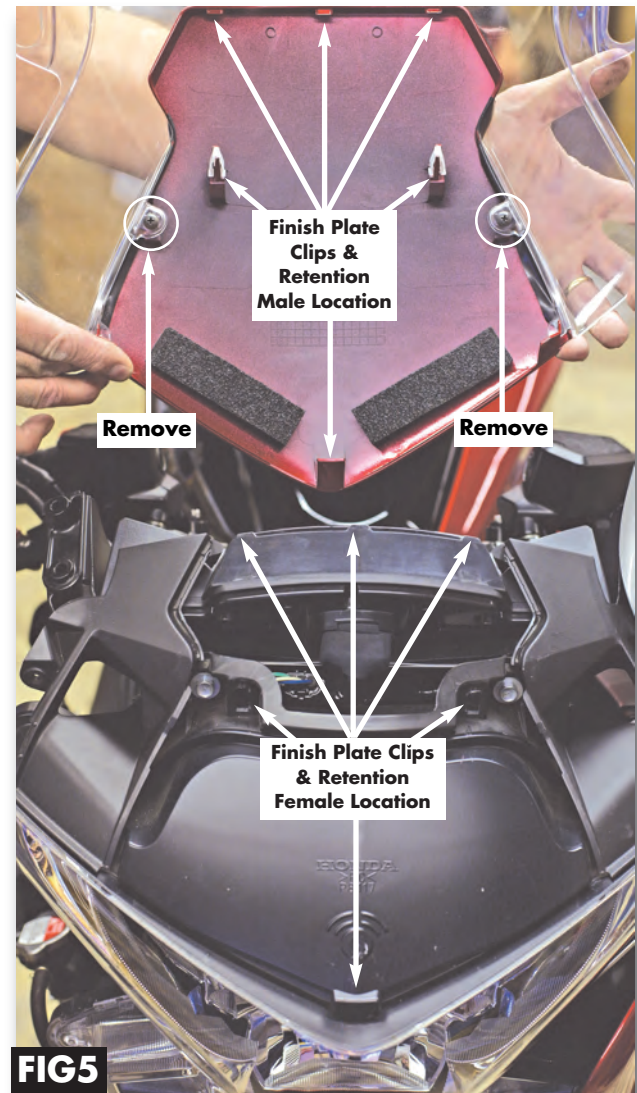

FIG5. Overview of Windscreen and finish plate removing locations.

Note: The finish plate is attached to the stock windscreen by two phillips screws.



FIG6. Now you are ready to unlock the screen from the fairing. **Apply light pressure** from the **top of the back side** of the **finish plate**. There are three retention locations on top to dislodge and also one located at the very bottom of the finish plate. Apply light pressure separating the clip from the fairing, and slide the windscreen/finish plate down. **Note:** The finish plate is attached to the stock windscreen.

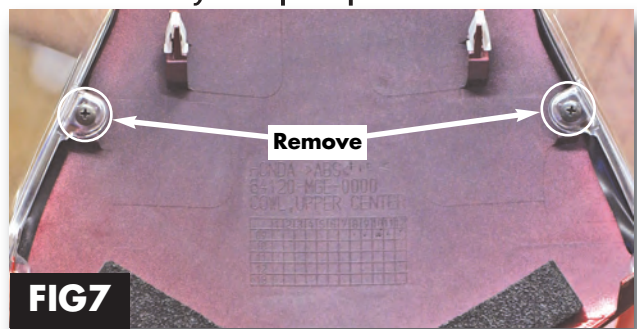

FIG7. Now you are ready to separate the finish plate from the stock windscreen. Locate the two Phillips screws and remove.

HONDA VFR 1200F 2010 - 2013 DIY WINDSCREEN INSTALL



FIG 8. Remove both left and right factory rubber grommet and install them to Zero Gravity screen (as shown above.) Then assemble one small plastic washer (provided) to each of the four factory allen screws.



Fig 9. Replace finish plate back to it's respected location. Starting from the bottom clip and work your way up.

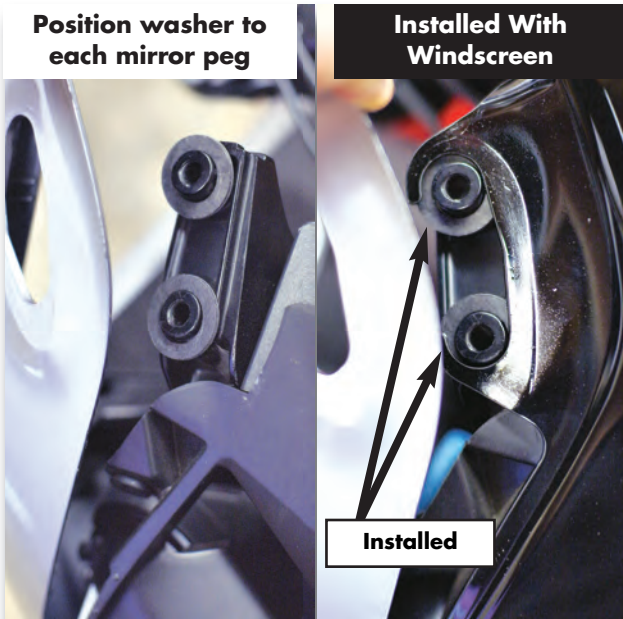

FIG 10
Fig 10. Before installing windscreen, place one washer to each of the mirror peg (as shown above.) The windscreen WILL BE ON TOP of these washers.

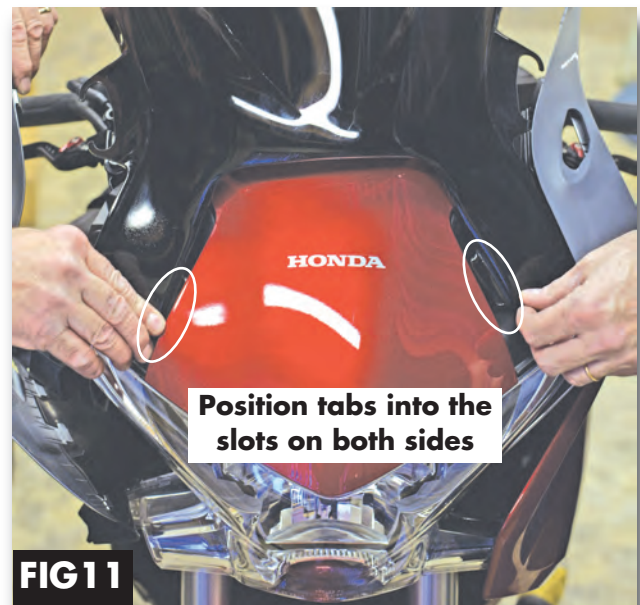

FIG 11
Fig 11. Carefully pull back on the top side fairing while slipping the ZG screen tabs into the appropriate slots. Use the mirror mounting point for a reference to position the screen. Install provided allen screws and plastic washers. Bolt on side mirrors to finish.

Note: Revert back to Fig 5 ~ Fig 10 if alignment is not achieved.

Please see www.zerogravity-racing.com for further information concerning this product.