

GUIDE ELEMENTS



Material: 1.7139, ca. 700 HV

How to Order:

- 1 Piece H00/9x12/25
- 3 Piece H00/10x12/25

Special Dimensions on request.

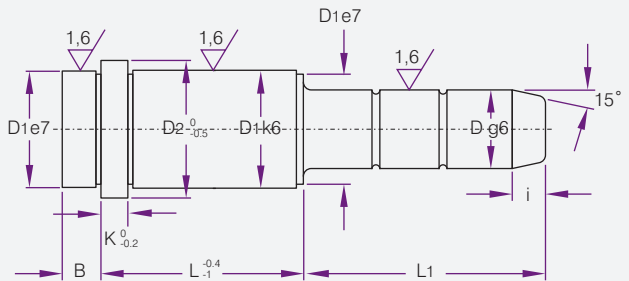

B	K	D1	D2	i	D	L	L1
3	3	14	16	4	9/10	12	25
							45
							65
3	3	14	16	4	9/10	17	20
							25
							30
							35
							50
							55
							70
							75
3	3	14	16	4	9/10	22	25
							35
							55
							75
							95
3	3	14	16	4	9/10	27	20
							25
							30
							45
							50
							70
							90
3	3	14	16	4	9/10	36	25
							35
							45
							65
							85
3	3	14	16	4	9/10	46	30
							35
							45
							70
3	3	14	16	4	9/10	56	35
							60
9	6	20	25	5	14/15	17	35
							55
							75
							95

B	K	D1	D2	i	D	L	L1
9	6	20	25	5	14/15	22	30
							50
							70
							90
							110
							125
							150
9	6	20	25	5	14/15	27	30
							45
							65
							85
							105
							125
							145
							165
9	6	20	25	5	14/15	36	35
							55
							75
							95
							125
							155
9	6	20	25	5	14/15	46	35
							45
							65
							85
							105
							125
							145
9	6	20	25	5	14/15	56	35
							55
							75
							95
							135
9	6	20	25	5	14/15	66	55
							65
							95
							125
9	6	20	25	5	14/15	76	55
							95



Material: 1.7139, ca. 700 HV

How to Order:

- 1 Piece H00/14x86/55
- 3 Piece H00/15x86/55

Special Dimensions on request.

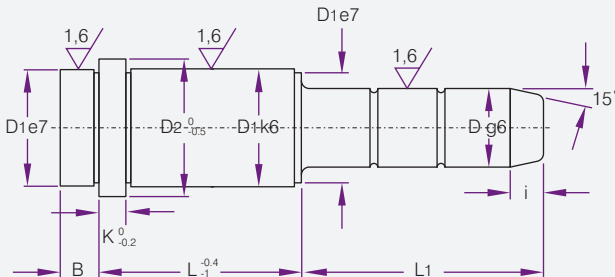

B	K	D1	D2	i	D	L	L1
9	6	20	25	5	14/15	86	55
							95
9	6	20	25	5	14/15	96	55
							95
9	6	20	25	5	14/15	116	75
9	6	26	31	7	18/20	17	35
							55
							75
							120
9	6	26	31	7	18/20	22	35
							45
							65
							85
							115
9	6	26	31	7	18/20	27	35
							45
							65
							85
							105
							125
							165
							225
							245
9	6	26	31	7	18/20	36	35
							55
							75
							95
							115
							135
							165
							225
							255
9	6	26	31	7	18/20	46	35
							45
							65
							85
							105
							135
							165
							205
							245
							245

B	K	D1	D2	i	D	L	L1
9	6	26	31	7	18/20	56	35
							55
							75
							95
							155
9	6	26	31	7	18/20	66	35
							55
							75
							95
							145
9	6	26	31	7	18/20	76	55
							75
							95
							135
9	6	26	31	7	18/20	86	55
							75
							95
							125
9	6	26	31	7	18/20	96	55
							95
9	6	26	31	7	18/20	116	75
							115
9	6	26	31	7	18/20	136	135
9	6	30	35a	7	22/24	17	35
							55
							75
9	6	30	35	7	22/24	22	35
							55
							75
							105
							130
9	6	30	35	7	22/24	27	35
							45
							65
							85
							105
							125
							165
							205
							245
							285



Material: 1.7139, ca. 700 HV

How to Order:

1 Piece H00/22x36/35

3 Piece H00/24x36/35

Special Dimensions on request.

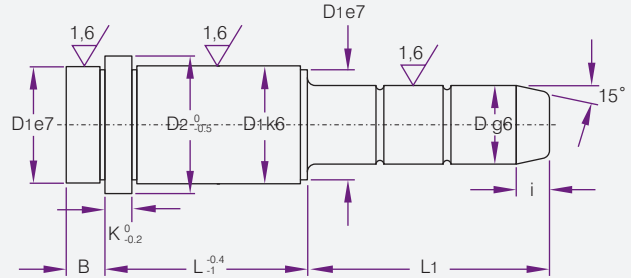

B	K	D1	D2	i	D	L	L1
9	6	30	35	7	22/24	36	35
							55
							75
							95
							115
							135
							165
							205
							245
							285
9	6	30	35	7	22/24	46	35
							45
							65
							85
							105
							125
							165
							205
9	6	30	35	7	22/24	56	35
							55
							75
							95
							115
							165
							205
9	6	30	35	7	22/24	66	35
							55
							75
							95
							155
9	6	30	35	7	22/24	76	55
							75
							95
							115
							145

B	K	D1	D2	i	D	L	L1
9	6	30	35	7	22/24	86	55
							75
							95
							135
9	6	30	35	7	22/24	96	55
							75
							95
							125
9	6	30	35	7	22/24	116	75
							115
							155
9	6	30	35	7	22/24	136	95
							135
9	6	30	35	7	22/24	156	155
9	6	42	47	7	30/32	27	45
							65
							105
							165
							185
							245
							285
9	6	42	47	7	30/32	36	55
							75
							95
							115
							155
							245
							285
9	6	42	47	7	30/32	46	45
							65
							85
							105
							125
							165
							245
							285



Material: 1.7139, ca. 700 HV

How to Order:

- 1 Piece H00/30x56/55
- 3 Piece H00/32x56/55

Special Dimensions on request.

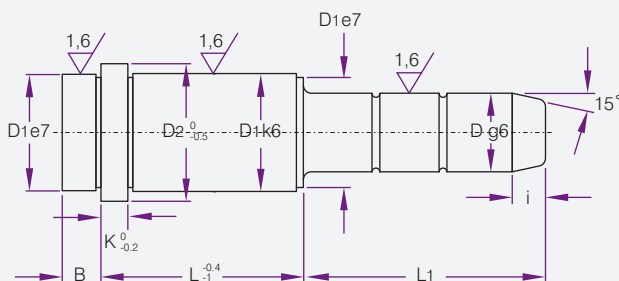

B	K	D1	D2	i	D	L	L1
9	6	42	47	7	30/32	56	55
							75
							95
							115
							135
							175
							245
							295
9	6	42	47	7	30/32	66	55
							75
							95
							115
							135
							175
							245
							295
9	6	42	47	7	30/32	76	55
							75
							95
							115
							155
							225
9	6	42	47	7	30/32	86	55
							75
							95
							115
							155
							225
9	6	42	47	7	30/32	96	55
							75
							95
							115
							155
							205
9	6	42	47	7	30/32	116	75
							115
							155

B	K	D1	D2	i	D	L	L1
9	6	42	47	7	30/32	136	95
							115
							155
9	6	42	47	7	30/32	156	115
							155
9	6	42	47	7	30/32	196	155
							195
12	10	54	60	10	40/42	46	95
							165
12	10	54	60	10	40/42	56	75
							115
							155
							195
12	10	54	60	10	40/42	66	75
							135
12	10	54	60	10	40/42	76	75
							115
							175
12	10	54	60	10	40/42	86	75
							135
12	10	54	60	10	40/42	96	75
							115
							155
12	10	54	60	10	40/42	116	95
							135
							195
12	10	54	60	10	40/42	136	95
							135
							215
12	10	54	60	10	40/42	156	115
							155
							215
12	10	54	60	10	40/42	196	155
							195
							235
12	10	54	60	10	40/42	246	165
							245



Material: 1.7139, ca. 700 HV

How to Order:

- 1 Piece H03/9x12/45
- 3 Piece H03/10x12/45

Special Dimensions on request.

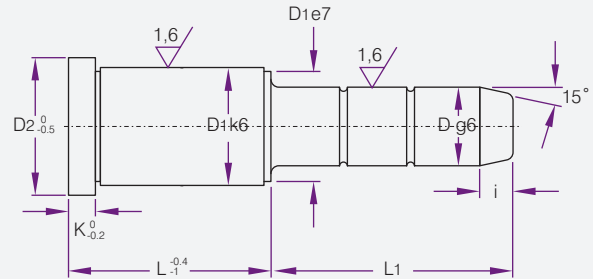

K	D1	D2	i	D	L	L1
3	14	16	4	9/10	12	45
3	14	16	4	9/10	17	20
						30
						35
3	14	16	4	9/10	22	25
						35
						55
3	14	16	4	9/10	27	25
						30
						35
						45
						50
3	14	16	4	9/10	36	25
						35
						45
3	4	16	4	9/10	46	30
						45
						55
						75
6	20	25	5	14/15	22	20
						35
						40
						45
						50
						55
						65
						70
						90
						110
6	20	25	5	14/15	27	20
						35
						40
						45
						55
						65
						85
						105

K	D1	D2	i	D	L	L1
6	20	25	5	14/15	36	20
						35
						40
						45
						55
						65
						75
						95
6	20	25	5	14/15	46	20
						35
						45
						65
						85
						105
6	20	25	5	14/15	56	20
						35
						55
						75
						95
6	20	25	5	14/15	66	55
						65
						95
6	20	25	5	14/15	76	55
						95
6	20	25	5	14/15	86	55
						95
6	26	31	7	18/20	22	20
						35
						40
						45
						50
						55
						60
						65
						70
						80
						85
						115



Material: 1.7139, ca. 700 HV

How to Order:

- 1 Piece H03/18x27/20
- 3 Piece H03/20x27/20

Special Dimensions on request.

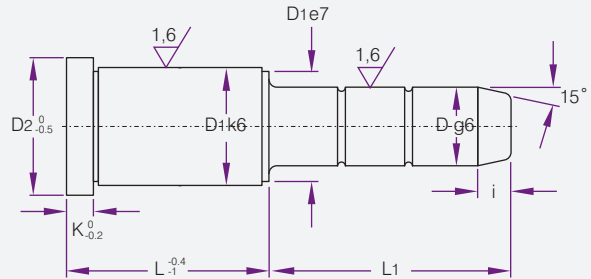

K	D1	D2	i	D	L	L1
6	26	31	7	18/20	27	20
						35
						40
						45
						50
						55
						60
						65
						70
						80
						85
						105
						125
6	26	31	7	18/20	36	20
						35
						40
						45
						50
						55
						60
						65
						70
						75
						80
						95
						115
						135
6	26	31	7	18/20	46	20
						45
						65
						85
						105
						135
						165
6	26	31	7	18/20	56	20
						35
						55
						75
						95

K	D1	D2	i	D	L	L1
6	26	31	7	18/20	66	55
						75
						95
6	26	31	7	18/20	76	55
						75
						95
6	26	31	7	18/20	86	55
						75
						95
6	26	31	7	18/20	96	55
						95
6	26	31	7	18/20	116	115
6	30	35	7	22/24	27	25
						45
						50
						60
						65
						70
						80
						85
						105
						125
						165
6	30	35	7	22/24	36	25
						45
						50
						55
						60
						70
						75
						80
						95
						115
						135
						165



Material: 1.7139, ca. 700 HV

How to Order:

- 1 Piece H03/22x46/25
- 3 Piece H03/24x46/25

Special Dimensions on request.

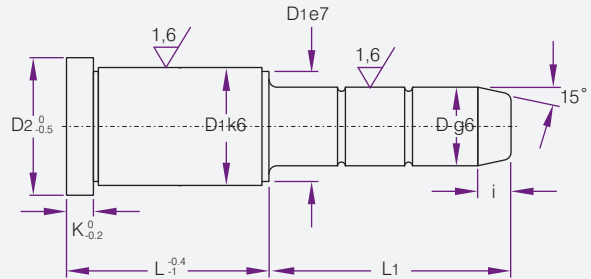

K	D1	D2	i	D	L	L1
6	30	35	7	22/24	46	25
						45
						50
						60
						65
						70
						80
						85
						105
						125
						165
6	30	35	7	22/24	56	25
						45
						55
						75
						95
						115
						165
6	30	35	7	22/24	66	55
						75
						95
6	30	35	7	22/24	76	25
						45
						55
						75
						95
						115
6	30	35	7	22/24	86	55
						75
						95
6	30	35	7	22/24	96	55
						75
						95
6	30	35	7	22/24	116	75
						115
						155
6	30	35	7	22/24	136	135

K	D1	D2	i	D	L	L1
6	42	47	7	30/32	27	45
						65
						105
						165
6	42	47	7	30/32	36	55
						75
						95
						115
						155
6	42	47	7	30/32	46	45
						65
						85
						105
						125
						165
6	42	47	7	30/32	56	55
						75
						95
						115
						135
						175
6	42	47	7	30/32	66	55
						75
						95
						115
						135
						175
6	42	47	7	30/32	76	55
						75
						95
						115
						155
6	42	47	7	30/32	86	55
						75
						95
						115
						155



Material: 1.7139, ca. 700 HV

How to Order:

- 1 Piece H03/30x96/55
- 3 Piece H03/32x96/55

Special Dimensions on request.

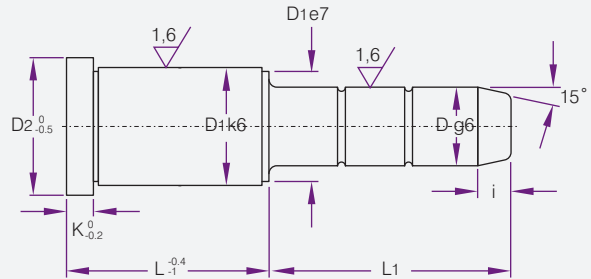

K	D1	D2	i	D	L	L1
6	42	47	7	30/32	96	55
						75
						95
						115
						155
6	42	47	7	30/32	116	75
						115
						155
6	42	47	7	30/32	136	95
						115
						155
6	42	47	7	30/32	156	115
						155
6	42	47	7	30/32	196	155
						195
10	54	60	10	40/42	56	75
						115
						155
						195
10	54	60	10	40/42	66	75
						135
10	54	60	10	40/42	76	75
						115
						175
10	54	60	10	40/42	86	75
						135
10	54	60	10	40/42	96	75
						115
						155
10	54	60	10	40/42	116	95
						135
						195
10	54	60	10	40/42	136	95
						135
						215
10	54	60	10	40/42	156	115
						155
						215

K	D1	D2	i	D	L	L1
10	54	60	10	40/42	196	155
						195
						235
10	66	72	10	50/52	96	115
						155
						195
10	66	72	10	50/52	116	135
						155
						195
10	66	72	10	50/52	136	135
						155
						195
10	66	72	10	50/52	156	155
						195
						235
10	66	72	10	50/52	196	175
						195
						235
20	80	86	10	60/62	96	115
						155
						195
20	80	86	10	60/62	116	135
						155
						195
20	80	86	10	60/62	136	135
						155
						195
20	80	86	10	60/62	156	155
						195
						235
20	80	86	10	60/62	196	175
						195
						235
20	80	86	10	60/62	246	195
						235
						275
						315

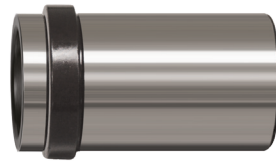

Material: 1.7139, ca. 700 HV

How to Order:

- 1 Piece H10/9x12
- 3 Piece H10/10x12

Special Dimensions on request.

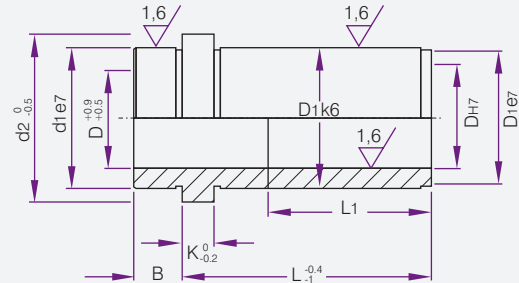

B	K	d1	d2	L1	D	L
3	3	14	16	-	9/10	12
						17
						22
						27
						36
						46
						56
						66
9	6	20	25	-	14/15	17
						22
						27
						36
						46
						56
						66
						76
						86
						96
						116
9	6	26	31	-	18/20	17
						22
						27
						36
						46
						56
						66
						76
						86
						96
						116
						136

B	K	d1	d2	L1	D	L
9	6	30	35	-	22/24	17
						22
						27
						36
						46
						56
						66
						76
						86
						96
9	6	42	47	96	30/32	27
						36
						46
						56
						66
						76
						86
						96
						116
						136
						156
						176
						196
12	10	54	60	-	40/42	36
						46
						56
						66
						76
						86
						96
						116
						136
						156
						176
						196
						216
						246

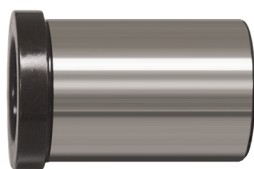

Material: 1.7139, ca. 700 HV

How to Order:

- 1 Piece H11/9x9
- 3 Piece H11/10x9

Special Dimensions on request.

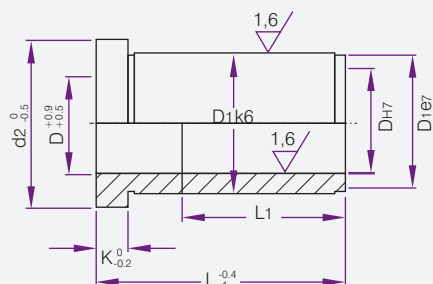

K	d1	d2	L1	D	L
3	14	16	-	9/10	9
					12
					17
					22
					27
					36
			36		46
					56
					66
6	18	23	-	12	17
					22
					27
					36
			36		46
					56
6	20	25	-	14/15	12
					17
					22
					27
					36
			46		56
					66
					76
					86
					96
6	22	27	-	16	17
					22
					27
					36
					46
					56

K	d1	d2	L1	D	L
6	26	31	-	18/20	17
					22
					27
					36
					46
					56
			56		66
					76
					86
					96
					116
6	30	35	-	22/24	17
					22
					27
					36
					46
					56
					66
					76
			76		86
					96
					116
					136
					156
6	42	47	-	30/32	27
					36
					46
					56
					66
					76
					86
					96
			96		116
					136
					156
					176

K	d1	d2	L1	D	L
10	54	60	-	40/42	36
					46
					56
					66
					76
					86
					96
					116
			116		136
					156
					176
					196
					216
					246
10	66	72	-	50/52	56
					76
					96
					116
			116		136
					156
					176
					196
20	80	86	-	60/62	56
					76
					96
					116
					136
			136		156
					176
					196
					216
					246



Material: Brass

How to Order:

1 Piece H10W/9x12

Special Dimensions on request.

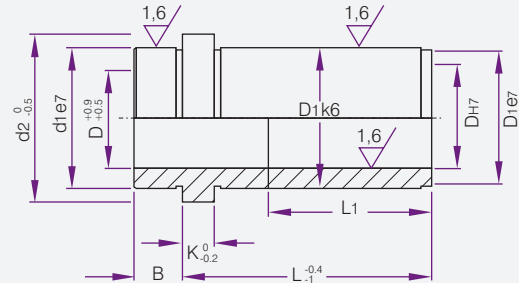

B	K	d1	d2	L1	D	L
3	3	14	16	-	9/10	12
						17
						22
						27
						36
						46
						56
						66
9	6	20	25	-	14/15	17
						22
						27
						36
						46
						56
						66
						76
						86
						96
						116
9	6	26	31	-	18/20	17
						22
						27
						36
						46
						56
						66
						76
						86
						96
						116
						136

B	K	d1	d2	L1	D	L
9	6	30	35	-	22/24	17
						22
						27
						36
						46
						56
						66
						76
						86
						96
						116
						136
						156
9	6	42	47	96	30/32	27
						36
						46
						56
						66
						76
						86
						96
						116
						136
						156
						176
						196
12	10	54	60	-	40/42	36
						46
						56
						66
						76
						86
						96
						116
						136
						156
						176
						196
						216
						246



Material: Brass

How to Order:

1 Piece H11W/9x12

Special Dimensions on request.

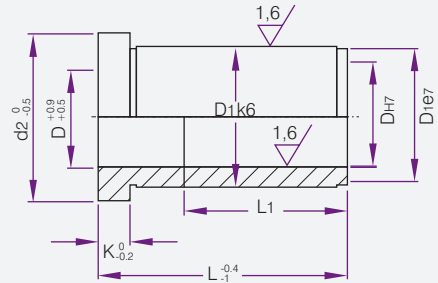

K	d1	d2	L1	D	L
3	14	16	-	9/10	9
					12
					17
					22
					27
					36
			36		46
					56
					66
6	18	23	-	12	17
					22
					27
					36
			36		46
					56
6	20	25	-	14/15	12
					17
					22
					27
					36
			46		56
					66
					76
					86
					96
6	22	27	-	16	17
					22
					27
					36
					46
					56

K	d1	d2	L1	D	L
6	26	31	-	18/20	17
					22
					27
					36
					46
					56
			56		66
					76
					86
					96
					116
6	30	35	-	22/24	17
					22
					27
					36
					46
					56
					66
					76
			76		86
					96
					116
					136
					156
6	42	47	-	30/32	27
					36
					46
					56
					66
					76
					86
					96
			96		116
					136
					156
					176

K	d1	d2	L1	D	L
10	54	60	-	40/42	36
					46
					56
					66
					76
					86
					96
					116
			116		136
					156
					176
					196
					216
					246
10	66	72	-	50/52	56
					76
					96
					116
			116		136
					156
					176
					196
20	80	86	-	60/62	56
					76
					96
					116
					136
			136		156
					176
					196
					216
					246



Material: 1.7139, ca. 700 HV

How to Order:

1 Piece H20/14x20

Special Dimensions on request.

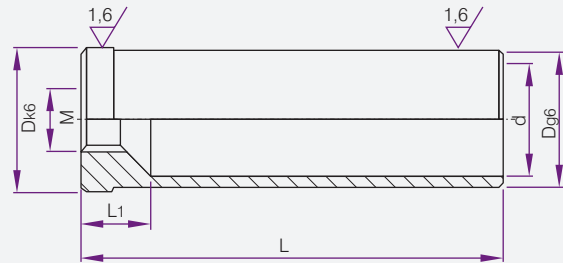

L1	M	d	D	L
8	8	11	14	20
				30
				40
				50
				60
				70
				80
				100
				120
				140
12	12	16	20	30
				40
				50
				60
				70
				80
				100
				120
				140
				160
12	12	21	26	30
				40
				50
				60
				70
				80
				100
				120
				140
				160

L1	M	d	D	L
12	12	25	30	40
				50
				60
				80
				100
				120
				140
				160
				180
				200
12	12	33	42	40
				60
				80
				100
				120
				140
				160
				180
				200
				220
12	12	43	54	60
				80
				100
				120
				140
				160
				200
				240
				280
				320



Material: SUJ2

Hardness: 58-62 HRC

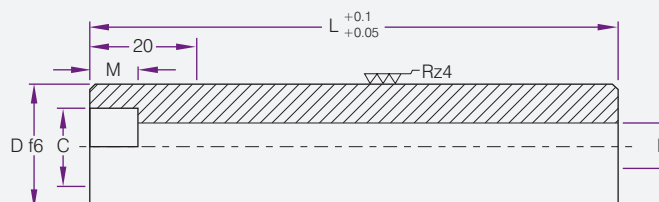

Product Code	ØD	C	M	B	L								
					50	60	70	80	90	100	120	140	
SP24 x L	24	15	9	9	◆	◆	◆	◆	◆	◆			
SP36 x L	36	18	11	11		◆	◆	◆	◆	◆	◆		
SP48 x L	48	20	13	13				◆		◆	◆	◆	

Ejector Guide Bushes GB



Material: SUJ2

Hardness: 58-62 HRC

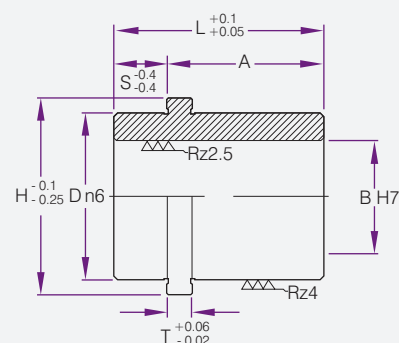

Product Code	ØB	D	H	S	T	L	A
GB1000	24	32	36	6	5	26	15
GB1001	36	44	48	6	5	30	19
GB1002	48	58	62	10	6	40	24



Material: 1.7139
ca. 700 HV

How to Order:
1 Piece H12/12x40

Special Dimensions on request.

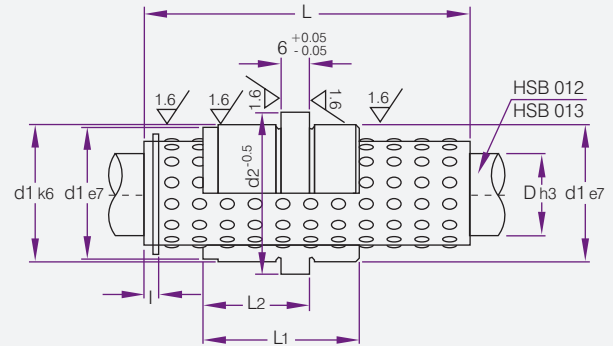

l	d1	d2	L1	L2	D	L
2,5	22	26	24	18	12	40
						56
2,8	30	35	34	23	18	45
						56
						71
4,8	46	52	54	33	30	56
						75
						95

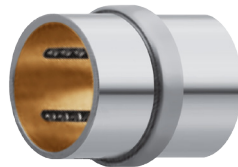

How to Order:

H13 17 x 12
(No.)(s2) (d1)

Special Dimensions on request.

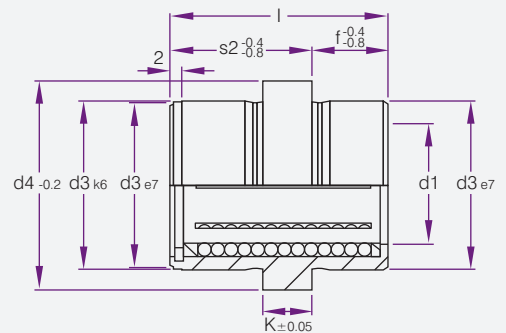

Product Code	s2	d1	d3	d4	l	f	k
H13 17 x 12	17	12	24	28	26	9	6
H13 17 x 24	17	24	39	43	29	12	6
H13 22 x 18	22	18	32	36	39	17	6
H13 22 x 30	22	30	50	54	39	17	6



Material: 1.7139
ca. 700 HV

How to Order:
1 Piece H012/12x80

Special Dimensions on request.

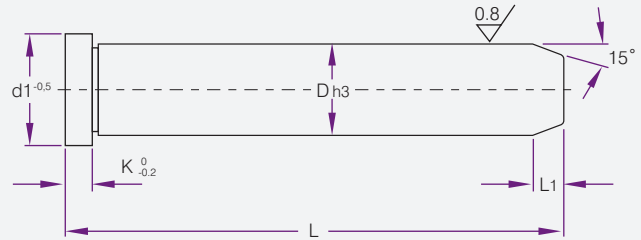

K	L1	D1	D	L
4	4	16	12	80
				100
				120
				140
6	7	22	18	80
				100
				120
				140
				160
				180
6	7	36	30	160
				200
				240
				280
				300



Material: SUJ2
Hardness: 58 HRC
How to Order:
 GLP 25 - L75 - 1
 (Type No.) (L) (Qty)
 Special Dimensions on request.

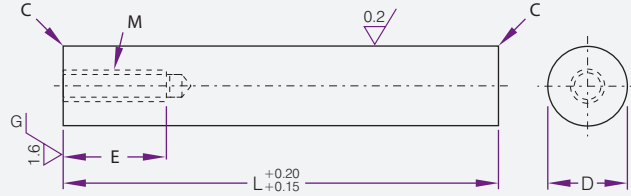

D	M x Pitch	E	Type No.		L					
			Type	D						
8	-0.015	M5 x 0.8	10	GLP	8	40 ~ 70				
				GLP	8	75 ~ 100				
10	-0.020			GLP	10	40 ~ 70				
				GLP	10	75 ~ 100				
12	-0.020 -0.025	M6 x 1.0	12	GLP	12	40 ~ 70				
				GLP	12	75 ~ 100				
GLP				13	40 ~ 70					
GLP				13	75 ~ 100					
13				-0.020	M6 x 1.0	12	GLP	13	105 ~ 125	
							GLP	13	130 ~ 150	
16	-0.025	M6 x 1.0	12	GLP	16	50 ~ 70				
				GLP	16	75 ~ 100				
				GLP	16	105 ~ 125				
				GLP	16	130 ~ 150				
20	-0.025 -0.030	M8 x 1.25	16	GLP	20	50 ~ 70				
				GLP	20	75 ~ 90				
				GLP	20	95 ~ 110				
				GLP	20	115 ~ 130				
				GLP	20	135 ~ 150				
				GLP	20	155 ~ 175				
				GLP	25	50 ~ 70				
				GLP	25	75 ~ 90				
				GLP	25	95 ~ 110				
				GLP	25	115 ~ 130				
25	-0.025 -0.030	M8 x 1.25	16	GLP	25	135 ~ 150				
				GLP	25	155 ~ 170				
				GLP	25	175 ~ 200				
				GLP	25	205 ~ 225				
				GLP	25	230 ~ 250				
				30	-0.025 -0.030	M10 x 1.5	20	GLP	30	50 ~ 70
								GLP	30	75 ~ 90
								GLP	30	95 ~ 110
								GLP	30	115 ~ 130
								GLP	30	135 ~ 150
GLP	30	155 ~ 170								
GLP	30	175 ~ 200								
GLP	30	205 ~ 225								
GLP	30	230 ~ 250								
GLP	30	255 ~ 275								
32	-0.025 -0.030	M10 x 1.5	20	GLP	32	50 ~ 70				
				GLP	32	75 ~ 90				
				GLP	32	95 ~ 110				
				GLP	32	115 ~ 130				

D	M x Pitch	E	Type No.		L	
			Type	D		
32	-0.025 -0.030	M10 x 1.5	20	GLP	32	135 ~ 150
				GLP	32	155 ~ 170
				GLP	32	175 ~ 200
				GLP	32	205 ~ 225
				GLP	32	230 ~ 250
				GLP	32	255 ~ 275
				GLP	32	280 ~ 300
				35	-0.025 -0.030	M10 x 1.5
GLP	35	75 ~ 90				
GLP	35	95 ~ 110				
GLP	35	115 ~ 130				
GLP	35	135 ~ 150				
GLP	35	155 ~ 170				
GLP	35	175 ~ 200				
GLP	35	205 ~ 225				
GLP	35	230 ~ 250				
GLP	35	255 ~ 275				
40	-0.025 -0.030	M10 x 1.5	20	GLP	40	50 ~ 70
				GLP	40	75 ~ 90
				GLP	40	95 ~ 110
				GLP	40	115 ~ 130
				GLP	40	135 ~ 150
				GLP	40	155 ~ 170
				GLP	40	175 ~ 200
				GLP	40	205 ~ 225
				GLP	40	230 ~ 250
				GLP	40	255 ~ 275
50	-0.025 -0.030	M10 x 1.5	20	GLP	40	280 ~ 300
				GLP	40	305 ~ 325
				GLP	40	330 ~ 350
				GLP	50	50 ~ 70
				GLP	50	75 ~ 90
				GLP	50	95 ~ 110
				GLP	50	115 ~ 130
				GLP	50	135 ~ 150
				GLP	50	155 ~ 170
				GLP	50	175 ~ 200
32	-0.025 -0.030	M10 x 1.5	20	GLP	50	205 ~ 225
				GLP	50	230 ~ 250
				GLP	50	255 ~ 275
				GLP	50	280 ~ 300

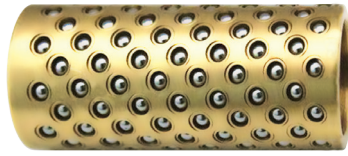

How to Order:

GAD 20 - L45 - 1
 (No.) (L) (Qty)

Special Dimensions on request.

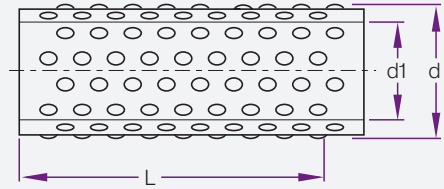

Ball Dia	d1	d	Type No.		L											
			Type	No.	25	30	35	40	45	50	55	60	65	70		
2	8.5	11.5	GAD	8												
2	10.5	13.5	GAD	10												
2	13.5	16.5	GAD	13												
2	16.5	19.5	GAD	16												
2	20.5	23.5	GAD	20												
2	25.5	28.5	GAD	25												
2	30.5	33.5	GAD	30												

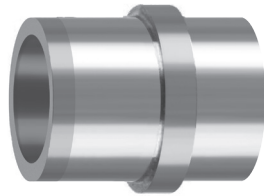

Material: SUJ2
Hardness: 58 HRC

How to Order:
 GBF 8 - 13 - 1
 (No.) (L) (Qty)

Special Dimensions on request.

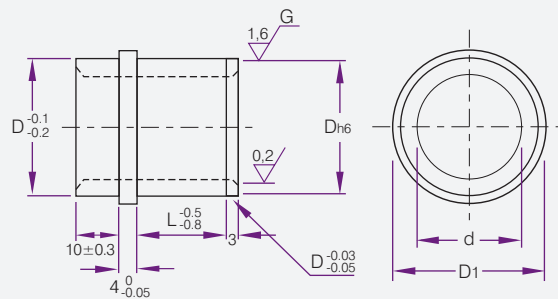

D1	Dh6		d		Type No.		L			
					Type	No.	13	15	20	25
19	16	0 -0.011	12	-0.025 -0.030	GBF	8				
21	18	0 -0.011	14	-0.025 -0.030	GBF	10				
25	22	0 -0.013	17	-0.030 -0.035	GBF	13				
28	25	0 -0.013	20	-0.030 -0.035	GBF	16				
33	30	0 -0.013	24	-0.035 -0.040	GBF	20				
38	35	0 -0.016	29	-0.035 -0.040	GBF	25				
43	40	0 -0.016	34	-0.035 -0.040	GBF	30				



Material: 1.7139

How to Order:

1 Piece H57/32x46

Special Dimensions on request.

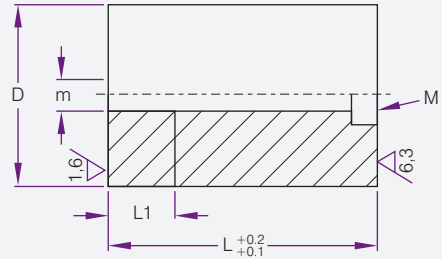

M	m	L1	D	L
M6	M8	15	32	46
				56
				66
				76
				86
				96
				116
M8	M10	20	40	46
				56
				66
				76
				86
				96
				116
M8	M10	20	50	46
				56
				66
				76
				86
				96
				116
M8	M10	20	50	136
				156

M8	M10	20	60	56				
				66				
				76				
				86				
				96				
				116				
				136				
M8	M10	20	63	156				
				176				
				M8	M10	20	63	56
								66
								76
								86
								96
116								
136								
M10	M12	25	70	156				
				176				
				M10	M12	25	80	66
								76
								86
								96
								116
136								
156								
M10	M12	25	80	176				