



Rack and Pinion Series Parts List



Index



Part Category	Pages
Control Box.....	2 - 6
RP Series Brake Resistor Box Parts.....	6
RP Series Pendant.....	7
RP Series Motor.....	8
RP Series Limit Switches.....	9
RP Series Rollers.....	10
RP Overspeed Safety Brake.....	10
RP General Parts.....	11 - 12
RP-2001 Latch Spring Anchor.....	13
RP-2001 Carriage Pivot Parts.....	13
RP-2001 Latch Bar Anchor.....	14
RP-2001 Ramp / Gate.....	15
RP-3003 Ramp / Gate.....	16
RP Series Accessories.....	17
Rp Series Decals.....	18 - 19





RP Series Control Box Parts



Qty	Part Number	Enclosure	Qty	Part Number	Mounting Plate
1	C2206		1	C2207	



Qty	Part Number	VFD	Qty	Part Number	RELAY SOCKET RAIL MOUNT
1	C2012		1	C1985	



Qty	Part Number	PLUG IN RELAY	Qty	Part Number	PLUG IN RELAY CLIP
1	C1984		1	C1986	



Qty	Part Number	PLC ZELIO Smart Logic	Qty	Part Number	24 Volt DC Step Down
1	C2010		1	C2011	

RP Series Control Box Parts



Qty	Part Number		Brake Rectifier	Qty	Part Number		Varistor
1	CC056			1	CC096		



Qty	Part Number		Diode	Qty	Part Number		RP-2001 3AMP Circuit Breaker
1	CC099			1	C2050		

Qty	Part Number		RP-3003 5AMP Circuit Breaker	Qty	Part Number		RP Series AUX Circuit Breaker
1	C2049			1	C2042		



Qty	Part Number		RP-2001 30AMP Circuit Breaker 2 pole	Qty	Part Number		RP-3003 30AMP Circuit Breaker 3 pole
1	C2048			2	C2102		

RP Series Control Box Parts

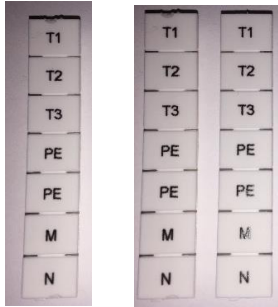

Qty	Part Number	Signal Terminal Block	Qty	Part Number	Motor Terminal Block
22	C2033		7* 14**	C2034	 *RP-2001 Qty 7, **RP-3003 Qty 14

Qty	Part Number	Motor Terminal Block PE	Qty	Part Number	Terminal Block End Clamp
2* 3**	C2035	 *RP-2001 Qty 2, **RP-3003 Qty 3	4	C2037	

Qty	Part Number	Marker For Signal Terminal Block	Qty	Part Number	Marker For Motor Terminal Block
1	C3651		1* 2**	C3650	 *RP-2001 Qty 1, **RP-3003 Qty 2



Qty	Part Number	Terminal Comb Jumpers	Qty	Part Number	Wireway Narrow with Cover
1	CC095		6	C2225	

RP Series Control Box Parts



Qty	Part Number		DIN Rail	Qty	Part Number		Din Rail Mount
4	C289			4	H105		

Qty	Part Number		RP-2001 Power Plug Male 1 Phase	Qty	Part Number		RP-3003 Power Plug Male 3 Phase
1	C1994			1	C1996		



Qty	Part Number		Pendant Plug Female	Qty	Part Number		Limit Switches Cord Grip White
1	C2072			3	C414		

Qty	Part Number		Pendant Cord Grip Blue	Qty	Part Number		Power In Cord Grip Purple
1	C388			1	C2554		



RP Series Control Box Parts

Qty	Part Number	Motor Cord Grips Purple	Qty	Part Number	90 Deg Strain Relief Orange
1* 2**	C2554		1	C3197	
*RP-2001 Qty 1, **RP-3003 Qty 2					

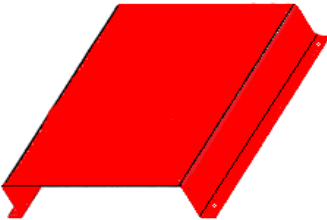

RP Series Brake Resistor Box Parts

Qty	Part Number	RP Series DC Brake Resistor	Qty	Part Number	All Thread
6	C2002		3	C2282	

Qty	Part Number	Resistor Box Plate	Qty	Part Number	Resistor Box Cover
1	20082		1	20081	



Qty	Part Number	Resistor Heat Resistant Wire	Qty	Part Number	Resistor Box Assembly
TBD	H100		1	20244	



RP Series Pendant Parts



Qty	Part Number		Pendant 2 Speed	Qty	Part Number		Pendant Male Plug
1	C719			1	C2071		



Qty	Part Number		Pendant Cable
TBD	C992		

RP Series Motor Parts

Qty	Part Number	Motor	Qty	Part Number	Motor Drive Pinion
1* 2**	A11104-29		1	RP14530	
*RP-2001 Qty 1, **RP-3003 Qty 2					



Qty	Part Number	Motor Cord Grip	Qty	Part Number	Motor to Control Box Cable
1	C1989		TBD		



Qty	Part Number	RP 5HP DC Motor Brake Assembly	Qty	Part Number	RP 5HP Motor Fan Blade
1	CMBA5HP		1	CFAN1730	

Qty	Part Number	RP 5HP Brake Lever/Bail	Qty	Part Number	RP Brake Lever/Bail Shifting Pin
1	H10000		2	H10001	

Qty	Part Number	RP Brake Lever/Bail Retaining Ring
2	H10002	



RP Series Limit Switches

Qty	Part Number	Limit Switch Roller Lever	Qty	Part Number	Limit Switch Spring Coil
TBD	A11991		TBD	C607	

Qty	Part Number	RP Limit Switch Inductive Proximity PORCELAIN TIP	Qty	Part Number	Limit Switch Inductive Proximity
TBD	C2141		TBD	C2140	

Qty	Part Number	RP Limit Switch Plunger Actuator
TBD	C2142	

RP Series Rollers

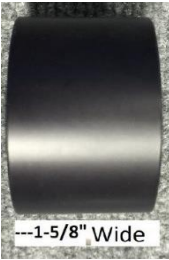

Qty	Part Number		RP Series Roller Large 2-5/8" OD 5/8" ID 2" Wide	Qty	Part Number		RP Series Roller Counter Bore 2-3/4 OD x 5/8 ID 1-5/8 W
4	20120		 <p>--- 2" Wide ---</p>	4	RP14531		  <p>---1-5/8" Wide</p>



Qty	Part Number		RP Series Roller Small 2-3/4" OD 5/8" ID 1-1/4" Wide
2	20405		 <p>---1-1/4" Wide</p>



RP Series Overspeed Safety Brake

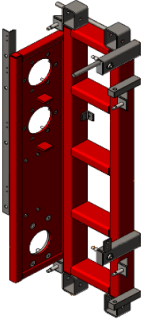

Qty	Part Number		RP Series Over Speed Safety Brake
1	B12725		

RP Series General Parts

Qty	Part Number	Liberty RP-2001 Platform	Qty	Part Number	Freedom RP-3003 Platform
1	20479		1	RP14539	



Qty	Part Number	RP Series Carriage	Qty	Part Number	RP Series Large Base
1	20591		1	RP14550	



Qty	Part Number	RP Series A Frame	Qty	Part Number	RP Series Lower Limit Stop (A-Frame)
1	20163		1	20164	



Qty	Part Number	RP Series Control Box & Resistor Box Support	Qty	Part Number	RP Series Cable Support Arm
1	20217		1	RP14553	

RP Series General Parts



Qty	Part Number		RP Series Control Box Access Door Panel	Qty	Part Number		Control Box Enclosure Mounting Brackets
1	RP14616			2	RP14627		



Qty	Part Number		RP Series Limit Switch Switch Ramp Flag	Qty	Part Number		RP-2001 Junction Box
2	20224			2	C2967		

Qty	Part Number		Square Finishing Plug	Qty	Part Number		RP-2001 Junction Box Plate
2	C903			2	H101		

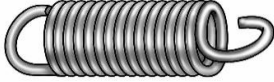

Qty	Part Number		RP-2001 Pivot Bumper	Qty	Part Number		Brake Pinion
2	H102			1	B12712		

RP-2001 Latch Spring Anchor Parts



Qty	Part Number		RP 2001 Pivot Latch Spring Anchor Angle	Qty	Part Number		RP 2001 Pivot Latch Spring Anchor
1	20480			2	C3187		



Qty	Part Number		RP 2001 Pivot Latch Spring Extension	Qty	Part Number		RP 2001 Pivot Latch Spring Twirl Nut
2	C2940			2	C1092		

RP-2001 Carriage Pivot Assembly Parts

Qty	Part Number		RP-2001 Thrust Bearing	Qty	Part Number		RP-2001 Pivot Bushing
2	CC038			2	RP14559		



RP-2001 Latch Bar Anchor Parts



Qty	Part Number		RP-2001 Pivot Latch	Qty	Part Number		RP-2001 Pivot Latch All Thread Used
1	RP14605			1	C2282-2.5		



Qty	Part Number		RP-2001 Pivot Latch Plastic Flange Bushing	Qty	Part Number		RP-2001 Pivot Latch Rod Thread Cover
2	C3203			1	H1003		

Qty	Part Number		Pivot Latch Rod Collar
2	C1960		



RP-2001 Ramp / Gate Parts



Qty	Part Number		RP-2001 Ramp / Gate	Qty	Part Number		Ramp Latch Rod
1	20219			1	20229-47		



Qty	Part Number		Ramp Pivot Rod	Qty	Part Number		Latch Rod Rubber Hose
1	20222-47			2	C538-3		

Qty	Part Number		Ramp Pivot Rod Collar	Qty	Part Number		Ramp Latch Shaft Collar
2	C1960			2	C2833		



RP-3003 Ramp / Gate Parts



Qty	Part Number		RP-3003 Ramp / Gate	Qty	Part Number		Ramp Latch Rod
1	20220			1	20229-64		

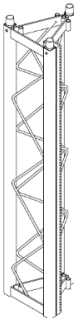

Qty	Part Number		Ramp Pivot Rod	Qty	Part Number		Latch Rod Rubber Hose
1	20222-64			2	C538-3		

Qty	Part Number		Ramp Pivot Rod Collar	Qty	Part Number		Ramp Latch Shaft Collar
2	C1960			2	C2833		

RP Series Accessories

Qty	Part Number		RP Series Tower Section White	Qty	Part Number		RP Series Safety Tower Top (YELLOW)
TBD	262040			TBD	B13735		

Qty	Part Number		RP Series Anchor Bracket (NON-PIVOT / PIVOT)	Qty	Part Number		RP Series Anchor Bracket (PIVOT)
TBD	20317			TBD	RP14595		

Qty	Part Number		RP Series Cable Guide	Qty	Part Number		RP Series Intermediate / Top Stop
TBD	B11521A			TBD	20292		

Qty	Part Number		RP Series Right Angle Clamp	Qty	Part Number		
TBD	C183						

RP Series Decals

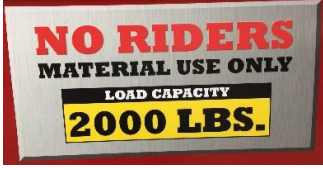
Qty	Part Number	RP 2001 No Riders 24" x 12"
1	DECNORIDE2001	 <p align="center">Lower Right Front Panel</p>

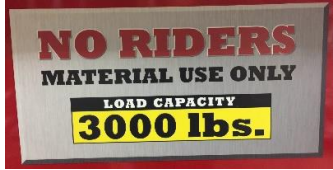
Qty	Part Number	RP 3003 No Riders 24" x 12"
1	DECNORIDE3003	 <p align="center">Lower Right Front Panel</p>

Qty	Part Number	RP Series Hi-Tech Hoist Flag w/ Web Site & Phone Number
1	DECHTHFLAG	 <p align="center">Lower Left Front Panel</p>

Qty	Part Number	RP Series Refer To Owners Manual 10" x 6"
1	DECPLATREAR	 <p align="center">Upper Left Back Panel</p>



Qty	Part Number	RP 2001 Platform 10" x 3.5"
1	DECPLAT2001	 <p align="center">Upper Left Back Panel</p>



Qty	Part Number	RP 3003 Platform 10" x 3.5"
1	DECPLAT3003	 <p align="center">Upper Left Back Panel</p>



Qty	Part Number	RP Series Control Panel Warning 12.25" x 16.25"
1	DECWARNING	 <p align="center">Center on Control Box Access Panel</p>

Qty	Part Number	RP Series Tower or A-Frame Switch Flag Decal 6"x 1-3/4"
1	DECTOWSWITCHFLAG	 <p align="center">Back of A-Frame Facing Out</p>

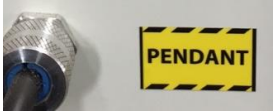
RP Series Decals

Qty	Part Number	HTH Series Single Phase Control Box	Qty	Part Number	HTH Series Three Phase Control Box
1	DEC1PHASECB	 <p>Control Box Above Power/Pendant Plug</p>	1	DEC3PHASECB	 <p>Control Box Above Power/Pendant Plug</p>

Qty	Part Number	RP and Patriot Series Control Box Pendant Decal	Qty	Part Number	RP and Patriot Series Control Box Power Decal
1	DECCBPENDANT	 <p>Control Box Beside Pendant Plug</p>	1	DECCBPOWER	 <p>Control Box Beside Power Plug</p>

Qty	Part Number	DECLIFTPOCK	Qty	Part Number	RP Decal Jacks are for leveling only
2	DECLIFTPOCK	 <p>Center Between Fork Pockets</p>	4	DECJACKLEVELING	 <p>Located Above Each Jack</p>

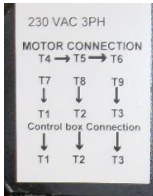
Qty	Part Number	RP Decal Warning High Voltage Hot Surface 7" x 4"	Qty	Part Number	RP Decal Motor Junction Box Wiring
1	DECHOTSURFACE	 <p>Center on Brake Resistor Cover</p>	1	DECMOTWIR	 <p>Center On Motor Junction Box</p>