

ALLDOCK

ALLDOCK WIRELESS

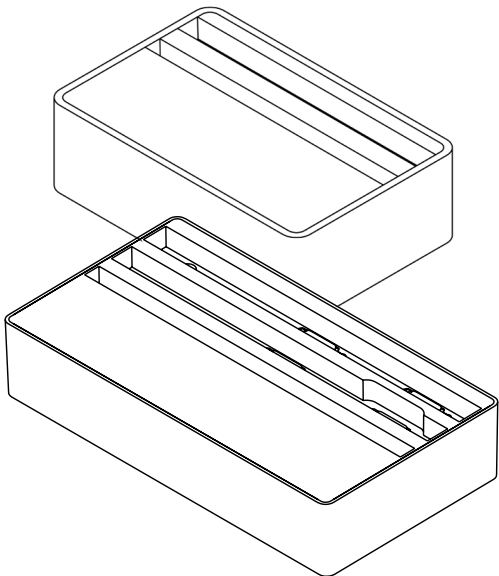

ALLDOCK WIRELESS FAMILY

ASSEMBLY INSTRUCTION

A. Scope of delivery

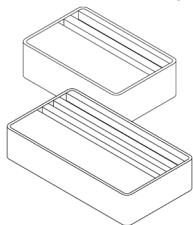

ALLDOCK WIRELESS or
ALLDOCK WIRELESS FAMILY

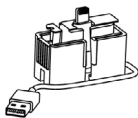

3x
ClickIn-Adapter +
Cable

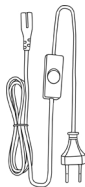

Power cable with
on/off-switch

B. Assembly

1. Plug power cable into ALLDOCK

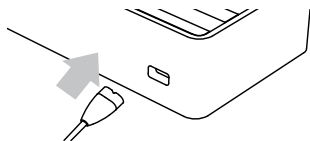

2. Dock the device

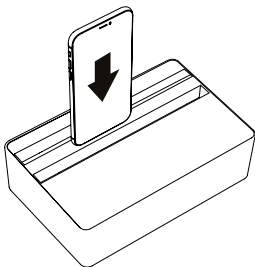

3. Place devices on
induction area

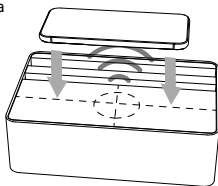

ALLDOCK WIRELESS

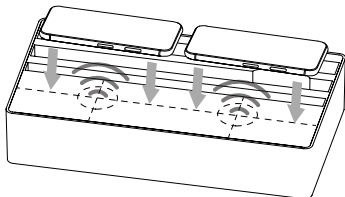

ALLDOCK WIRELESS FAMILY

C. Changing the connector positions

1. Lift off the lid of the ALLDOCK
2. Press the ClickIn adapter against the lever and pull it out

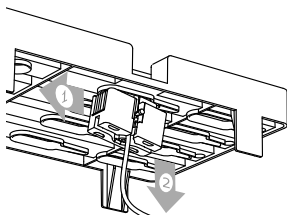

3. Click the ClickIn adapter back in at the selected position. Check the direction of the plug

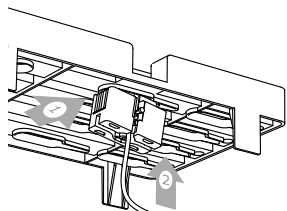

4. Close the lid

D. Charger

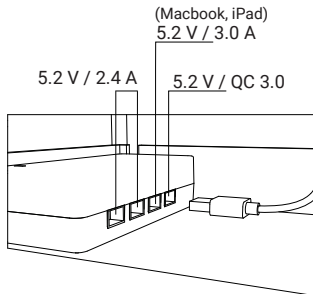

ALLDOCK CLASSIC

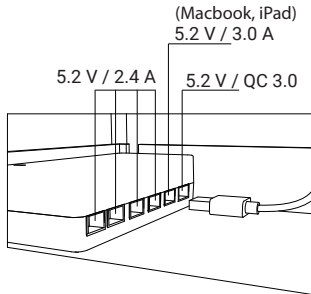

ALLDOCK CLASSIC FAMILY

E. charging slots

ALLDOCK WIRELESS

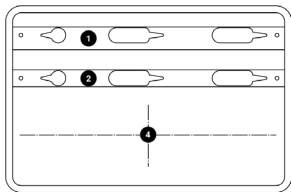

ALLDOCK WIRELESS FAMILY

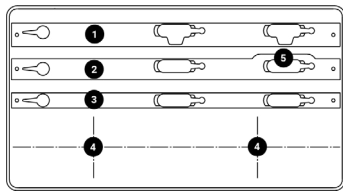

- 1** charging slot in the back
ALLDOCK WIRELESS depth: 18mm
ALLDOCK WIRELESS FAMILY depth: 21mm
for smartphones & Tablets with foldable covers
- 2** charging slot in the middle
ALLDOCK WIRELESS depth: 14mm
ALLDOCK WIRELESS FAMILY depth: 18mm
- 3** charging slot in the front
ALLDOCK WIRELESS FAMILY depth: 14mm
- 4** Wireless charging point (induction charging)
Smartphone should be centered on the marked number
- 5** Charging area for Airpods
and Airpods Pro

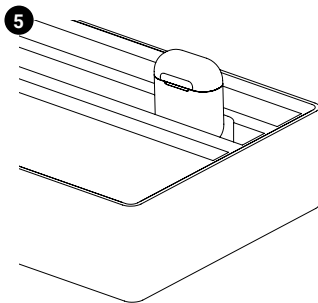

F. Erhältliches Zubehör/ Available accessories

1. ClickIn-Adapter

The Click-In Adapter from ALLDOCK simplifies the charging of your digital device with every ALLDOCK variation. It makes the cable search finally obsolete and enables uncomplicated one-hand docking.

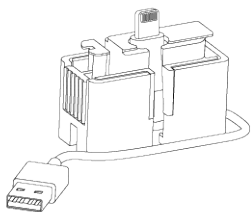

2. Y-splitcable

Do you want to upgrade them quickly and easily to charge an additional device with just one connection? Then our innovative YPSYLON split cable is exactly the right choice!

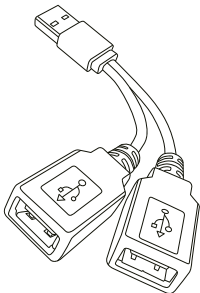

3. Mounts

Whether you want to charge your Apple Watch, AirPods or a Fitbit at your stylish charging station, ALLDOCK has the right equipment for you.

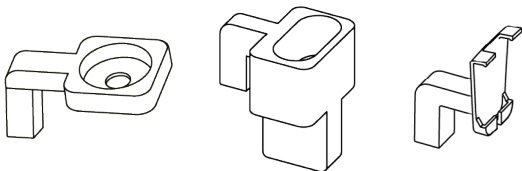

LIMITED WARRANTY AND DISCLAIMERS

WARRANTY:

The following ALDDOCK GmbH products are covered by this warranty for a period of one year (2 years EU) from the date of purchase by the original user customer: ALDDOCK WIRELESS/ALDDOCK WIRELESS FAMILY ALDDOCK GmbH warrants to the original end user customer that the ALDDOCK WIRELESS/ALDDOCK WIRELESS FAMILY is free from defects in material and workmanship. Subject to the conditions and limitations set forth below, ALDDOCK will, at its option, either repair or replace any part of the ALDDOCK WIRELESS/ALDDOCK WIRELESS FAMILY which proves defective by reason of improper workmanship or materials. Repaired parts or replacement products will be provided by ALDDOCK GmbH on an exchange basis, and will be either new or recertified. All recertified products are tested to ensure that they are functionally equivalent to new products if ALDDOCK GmbH is unable to repair or replace the product, it will refund or credit the lesser of either the current value of the product at the time the warranty claim is made or the purchase price.

This limited warranty does not cover any damage to the product resulting from improper installation, accident, abuse, misuse, natural disaster, insufficient or excessive electrical supply, abnormal mechanical or environmental conditions, or any unauthorized disassembly, repair or modification. This limited warranty shall not apply if: (i) the product was not used in accordance with any accompanying instructions, or (ii) the product was not used for its intended purpose. This limited warranty also does not apply to any product on which the original identification information has been altered, obliterated or removed, that has not been handled or packaged correctly, that has been sold as second-hand or that has been resold contrary to U.S. and other applicable export regulations.

In the event a product has been discontinued, ALDDOCK GmbH, at its sole discretion shall either repair the product, offer to replace it with a comparable product or provide a refund at the lesser of the purchase price or the product's current value. Repaired or replacement products will continue to be covered by this limited warranty for the remainder of the original warranty term or ninety (90) days, whichever is longer. This limited warranty is non-transferable.

This warranty does not cover shipping, removal, installation or any other related costs. The end user must pay any shipping charged when returning a product under warranty. Follow the instructions on alldock.com to submit a claim under this warranty.

DISCLAIMERS:

TO THE EXTENT PERMITTED BY APPLICABLE LAW, THE FOREGOING IS THE COMPLETE WARRANTY FOR ALDDOCK GMBH PRODUCTS AND SUPERSEDES ALL OTHER WARRANTIES AND REPRESENTATIONS, WHETHER ORAL OR WRITTEN. EXCEPT AS EXPRESSLY SET FORTH ABOVE, NO OTHER WARRANTIES ARE GIVEN WITH RESPECT TO ALDDOCK GMBH PRODUCTS AND ALDDOCK GMBH EXPRESSLY DISCLAIMS ALL WARRANTIES NOT STATED HEREIN, INCLUDING, TO THE EXTENT PERMITTED BY APPLICABLE LAW, ANY WARRANTY THAT MAY EXIST UNDER NATIONAL, STATE, PROVINCIAL OR LOCAL LAW INCLUDING BUT NOT LIMITED TO ANY IMPLIED WARRANTY OF NON-INFRINGEMENT, MERCHANTABILITY OR FITNESS FOR A PARTICULAR PURPOSE. ALL WARRANTIES, WHETHER EXPRESS OR IMPLIED, ARE LIMITED TO THE PERIODS OF TIME SET FORTH ABOVE. SOME STATES OR OTHER JURISDICTIONS DO NOT ALLOW THE EXCLUSION OF IMPLIED WARRANTIES OR LIMITATIONS ON HOW LONG AN IMPLIED WARRANTY LASTS, SO THE ABOVE LIMITATIONS MAY NOT APPLY TO YOU.

ALDDOCK GMBH PRODUCTS ARE NOT AUTHORIZED FOR USE AS CRITICAL COMPONENTS IN LIFE SUPPORT EQUIPMENT OR FOR APPLICATIONS IN WHICH THE FAILURE OR MALFUNCTION OF THE PRODUCTS WOULD CREATE A SITUATION IN WHICH PERSONAL INJURY OR DEATH IS LIKELY TO OCCUR. ALDDOCK GMBH SHALL NOT BE LIABLE FOR THE DEATH OF ANY PERSON OR ANY LOSS, INJURY OR DAMAGE TO PERSONS OR PROPERTY BY USE OF PRODUCTS USED IN APPLICATIONS INCLUDING, BUT NOT LIMITED TO, MILITARY OR MILITARY-RELATED EQUIPMENT, TRAFFIC CONTROL EQUIPMENT, DISASTER PREVENTION SYSTEMS AND MEDICAL OR MEDICAL-RELATED EQUIPMENT. ALDDOCK GMBH'S TOTAL LIABILITY UNDER THIS OR ANY OTHER WARRANTY, EXPRESS OR IMPLIED, IS LIMITED TO REPAIR, REPLACEMENT OR REFUND. REPAIR, REPLACEMENT OR REFUND ARE THE SOLE AND EXCLUSIVE REMEDIES FOR BREACH OF WARRANTY OR ANY OTHER LEGAL THEORY. TO THE FULLEST EXTENT PERMITTED BY APPLICABLE LAW, ALDDOCK GMBH SHALL NOT BE LIABLE TO THE PURCHASER OR END USER CUSTOMER OF A ALDDOCK GMBH PRODUCT FOR ANY DAMAGES, EXPENSES, LOST DATA, LOST REVENUES, LOST SAVINGS, LOST PROFITS, OR ANY INCIDENTAL OR CONSEQUENTIAL DAMAGES ARISING FROM THE PURCHASE, USE OR INABILITY TO USE THE ALDDOCK GMBH PRODUCT. EVEN IF ALDDOCK GMBH HAS BEEN ADVISED OF THE POSSIBILITY OF SUCH DAMAGES. SOME STATES OR OTHER JURISDICTIONS DO NOT ALLOW THE EXCLUSION OR LIMITATION OF INCIDENTAL OR CONSEQUENTIAL DAMAGES. SO THE ABOVE LIMITATIONS OR EXCLUSIONS MAY NOT APPLY TO YOU. THIS LIMITED WARRANTY GIVES YOU SPECIFIC LEGAL RIGHTS, AND YOU MAY ALSO HAVE OTHER RIGHTS WHICH VARY FROM STATE TO STATE OR JURISDICTION TO JURISDICTION. DECLARATION OF CONFORMITY: REQUEST A COPY OF THE DECLARATION OF CONFORMITY HERE: SUPPORT@ALDDOCK.COM OR SUPPORT@ALDDOCK.DE

ALldOCK



Facebook: @alldock



Instagram: @alldock_eu



Twitter: @alldock_eu

www.alldock.com
www.alldock.de