

# FITUEYES®

## CAMERA SYNC STRIP LIGHT

P14L1651B / P14L1851B

ISSUED: H

# What's in the box

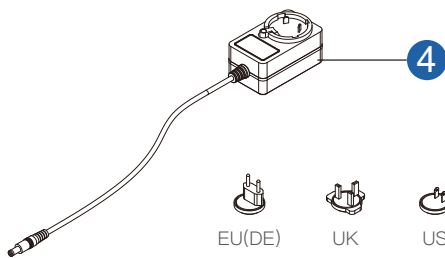
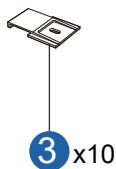
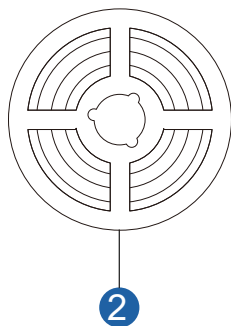
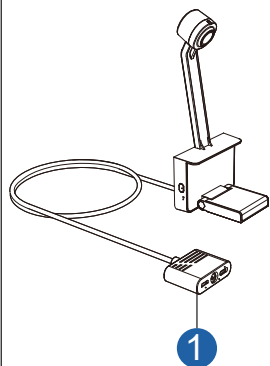

1	Camera	1
2	LED Strip Light	1
3	Clip	10
4	Adapter	1

## Control connection

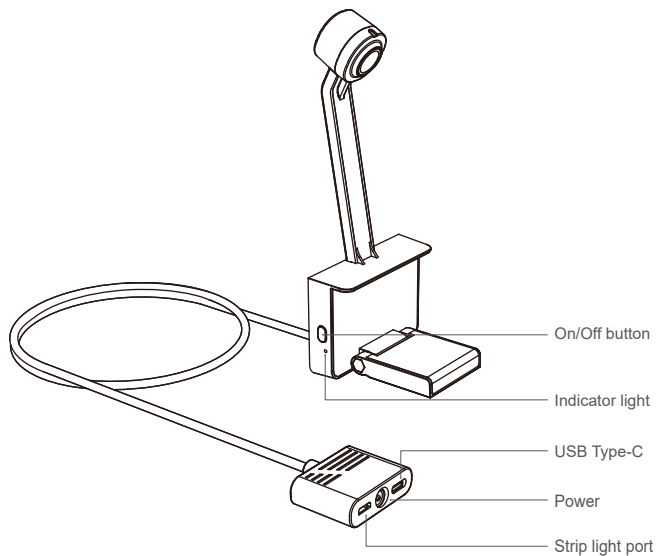

On/off button	a. Press to turn On/Off. b. Long press the On/Off button for 5 seconds till the strip light is off.Wait for around 10 seconds. Strip light will blink slowly or blink quickly to enter AP or EZ pairing mode.
Indicator light	Indicator light
USB Type-C	Connect to extra device (eg.light bar)
Power	DC power
Strip light port	Connect LED strip light

# Easy to install

## 1 Preparation Before Installing:

- Unbox the strip light check all items listed in the packing list.
- Power on the strip light and check whether it lights up.

## 2 Installing Steps:

- Wipe the installation surface (normally back of TV/PC) to ensure it is dry and clean.

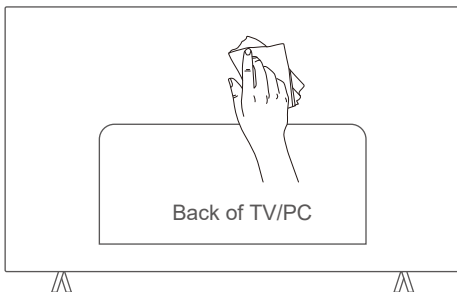

- Stick the strip light to the back of the TV. Press them firmly and then reinforce them with the provided clips. Please follow the arrow direction of the LED strip light.

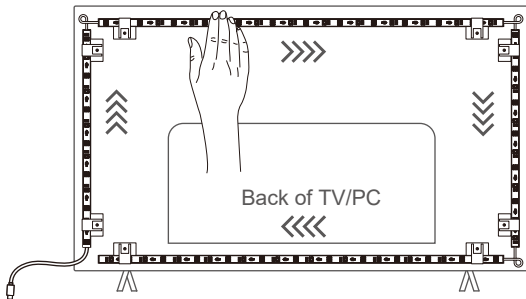

Note: You can also stick the strip light from any corner of the TV clockwise or anticlockwise. But please configure likewise in app later.

# Easy to install

c. Position the camera to the top-center of the TV horizontally.

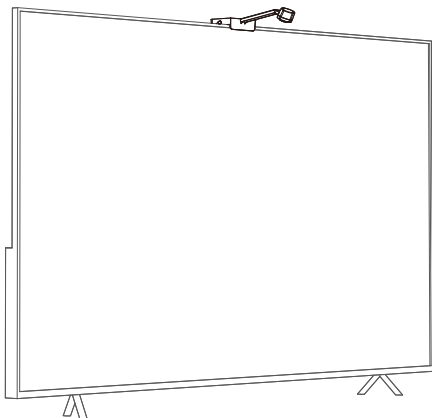

d. Insert the cable of the strip light and the power into the device.

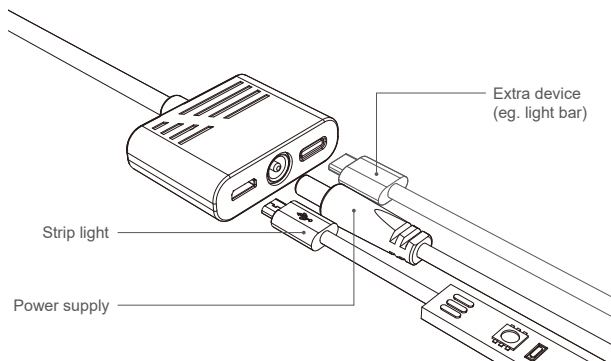

## Easy to install

e. Power on the strip light, tear off the protective film and try connecting them with the FITUEYES app.

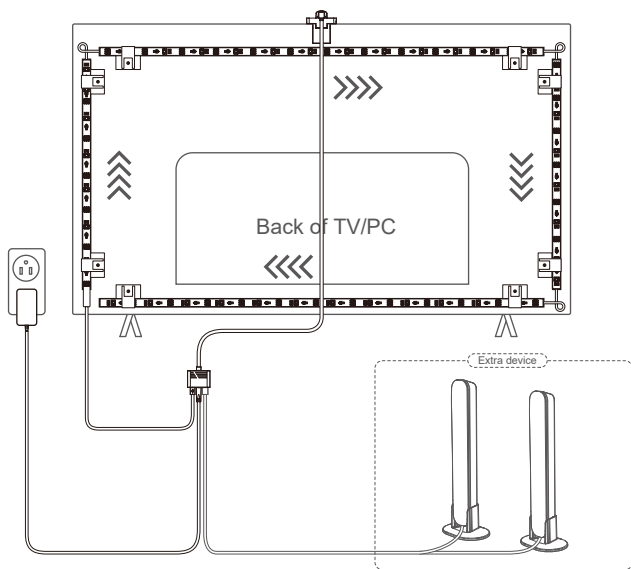
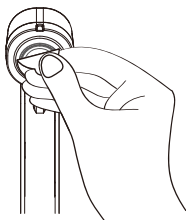

# App operation instructions

What you need:

- A Wi-Fi router supporting the 2.4GHz and 802.11 b/g/n bands. 5GHz is not supported.
- 1 Download the FITUEYES app from the App Store (iOS devices) or Google Play (Android devices).



FITUEYES APP

Download on the  
**App Store**

GET IT ON  
**Google Play**

- 2 Register an account.
- 3 Connect to the 2.4GHz Wi-Fi.

# App operation instructions

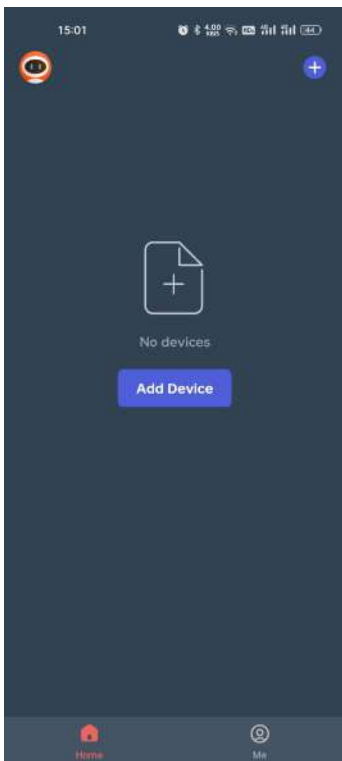
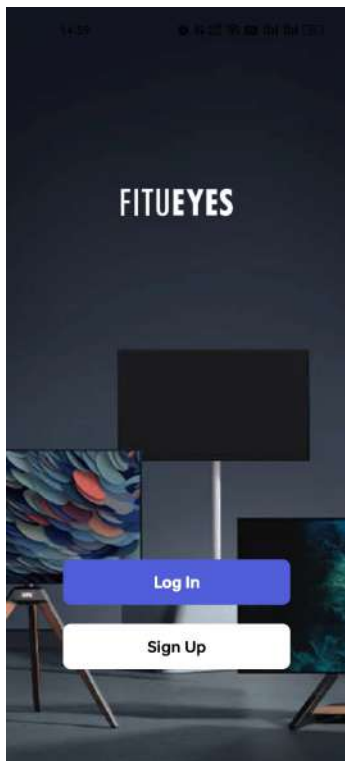

- 1 Download the FITUEYES app. Register and log in.
- 2 Click "+" or "Add Device".



# App operation instructions

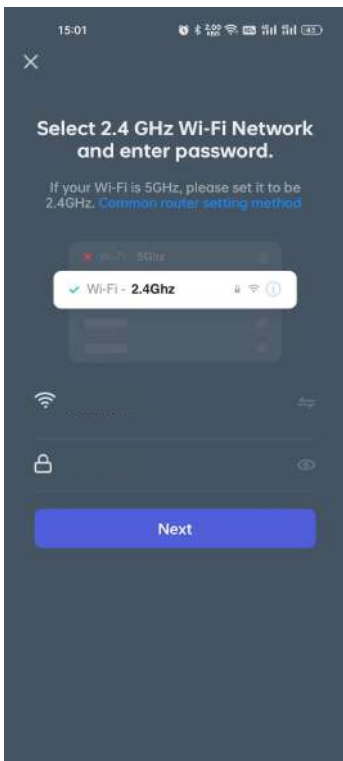
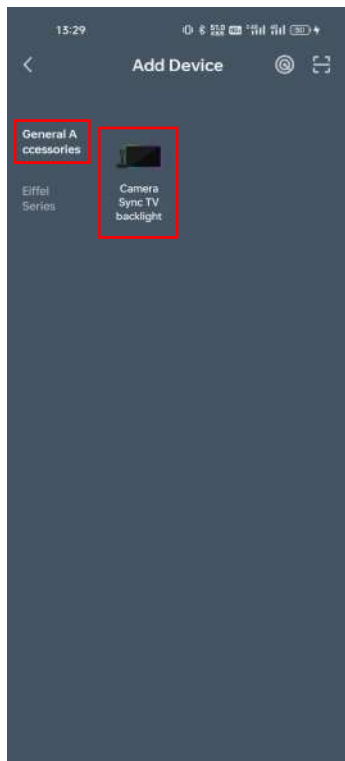

- 3 Select the Screen Sync Controller.
- 4 Enter 2.4GHz Wi-Fi network name and password, then tap "Next".

# App operation instructions

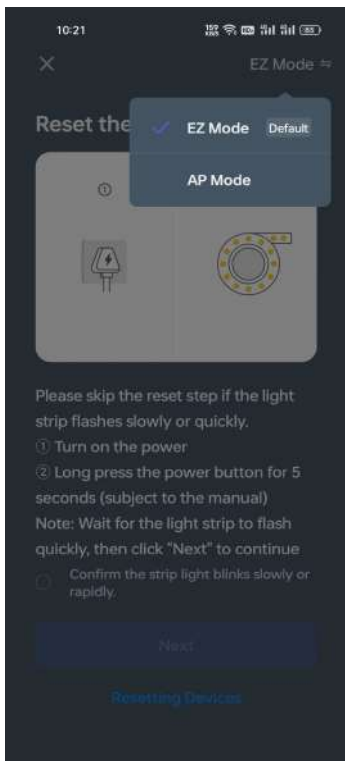

- 5 When the light strip flashes quickly, click "Confirm the strip light blinks slowly or rapidly", and then click "Next".  
Go to step: 10

- 6 If the light strip is flashing slowly, please click "EZ Mode" in the upper right corner and select "AP Mode".

# App operation instructions

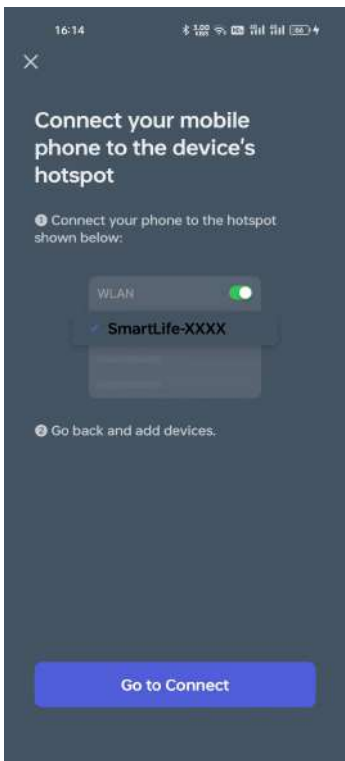

- 7 When the light strip shows slow flashing status, select "AP Mode", then click "Confirm the strip light blinks slowly or rapidly", and then click "Next".  
Go to steps: 8/9/10

- 8 Click "Go to Connect" to go to the hotspot connection.

# App operation instructions

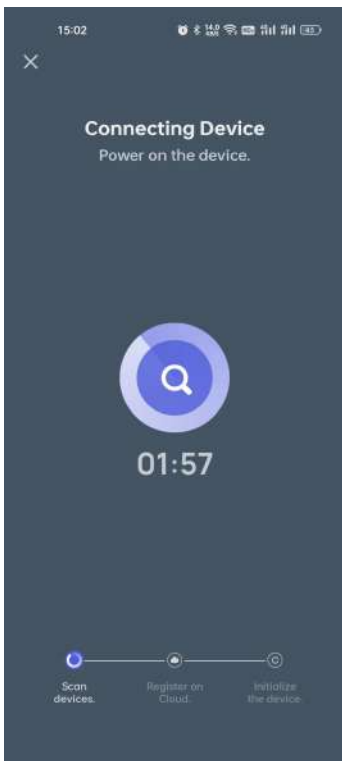
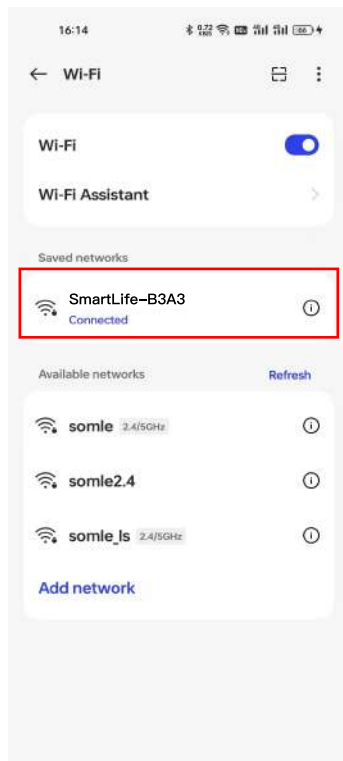

- 9 Select the corresponding "SmartLife-XXXX", wait until the status is connected, and click "Back".
- 10 Wait a moment.

# App operation instructions

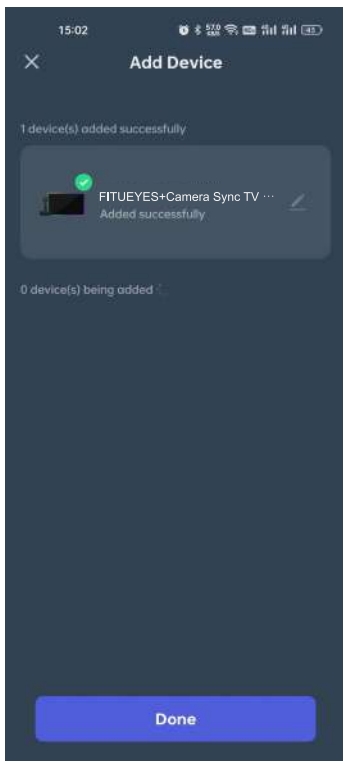

11 You can edit the camera name and click "Done".

12 Click "Next".

# App operation instructions



**Please select the light strip input position viewing from the front side of TV**

Upper left

Upper right

**Bottom left**

Bottom right



Next



**Please select the winding direction of the light strip viewing from the front side of TV**

**Clockwise**

Counterclockwise



Next

**13** Select the light strip input position, then tap "Next".

**14** Select the winding direction of the light strip, then tap "Next".

# App operation instructions

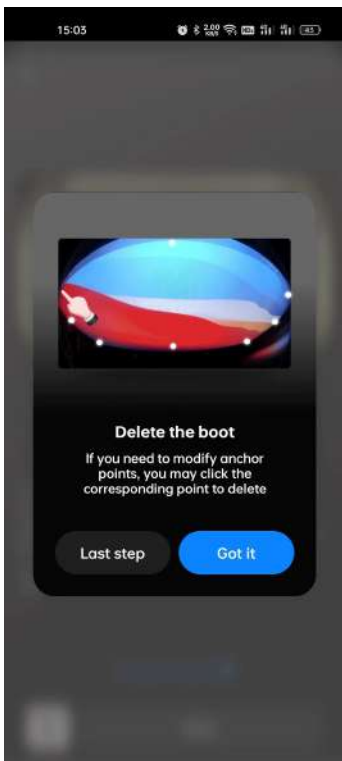

- 15 Read "Add the guide", then tap "Next step". 16 If you need delete the boot, click "Got it".

# App operation instructions

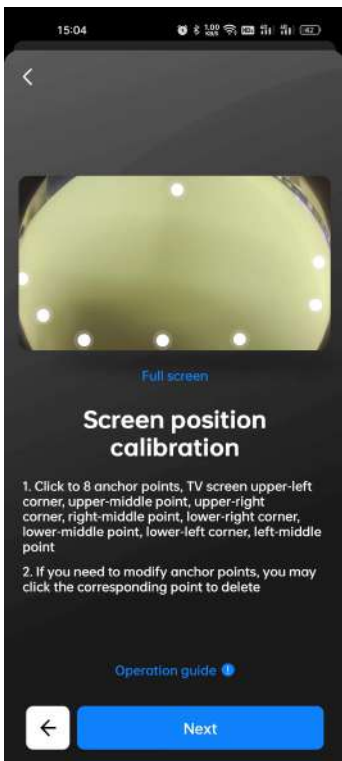
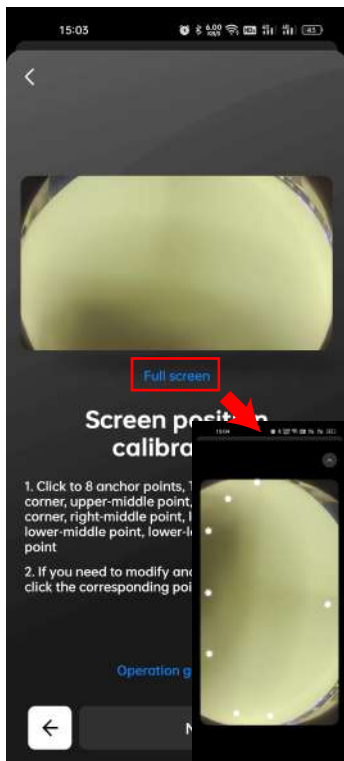

- 17 Click "Full Screen". Click on 8 anchor points, see the illustration for details.
- 18 Click "Next".



# App operation instructions

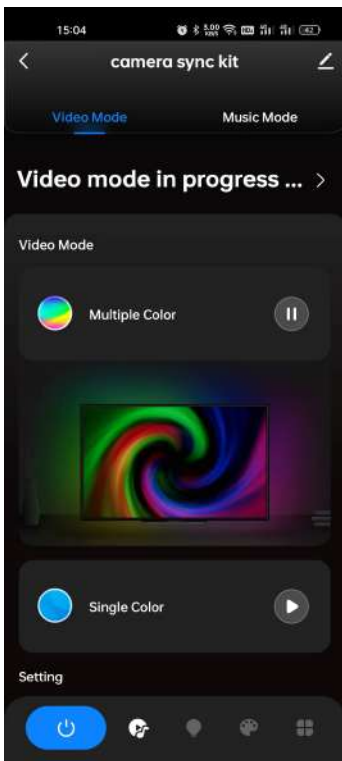
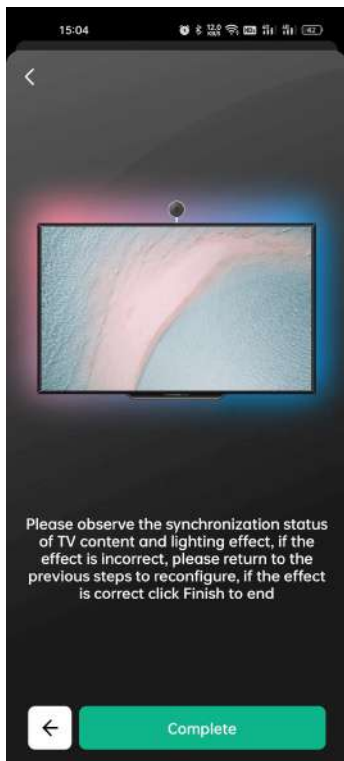

- 19 Observe the synchronization status of screen and lighting effect, then tap "Complete".
- 20 Connection is successful. Open Multiple Color choose Intensity you like.

