

numatics®

Proportional Technology

Precise Control of Pressure and Flow

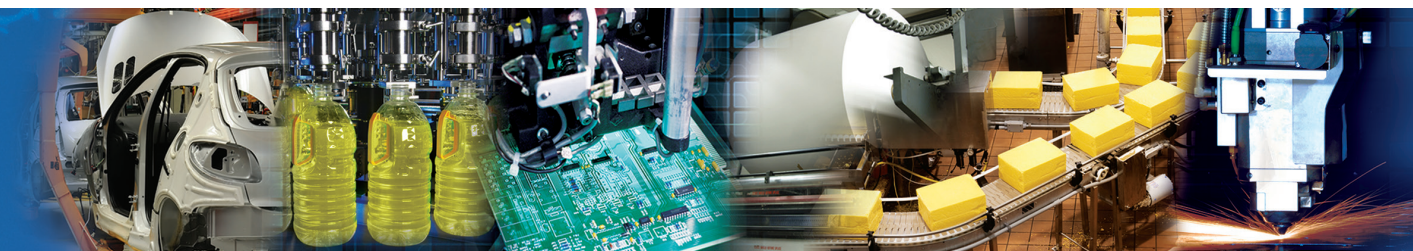
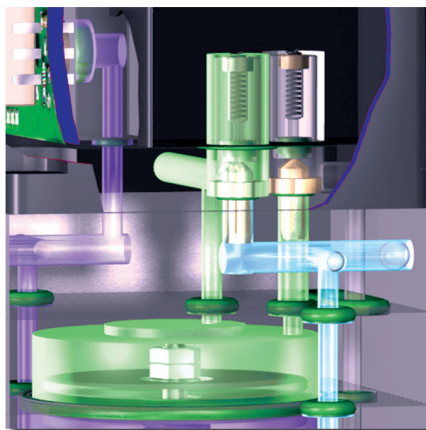
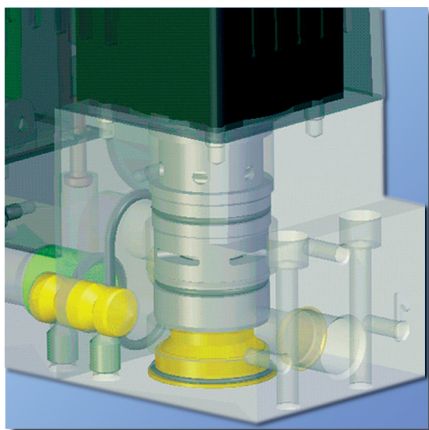
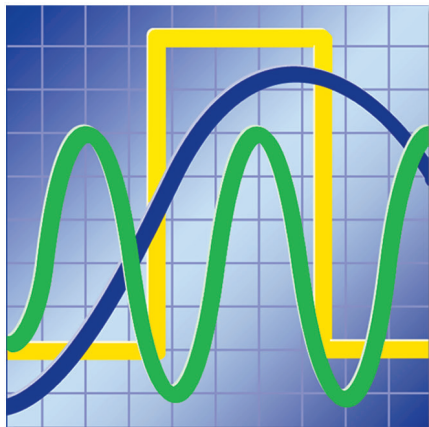

www.numatics.com

Numatics, Inc. is a leading manufacturer of pneumatic products and motion control products.

Our broad spectrum of standard, custom developed products and application components have made a significant impact on pneumatic innovation as well as pneumatic and motion control technology. Our company has an extensive history of generating innovative concepts and technological breakthroughs. Many of today's standard features in pneumatic technology were industry firsts from Numatics. We continue our innovative approach to product development by developing electric motion control solutions and enhancing our embedded Fieldbus and I/O products to continually meet and solve our customer's application requirements.



Today Numatics is proud to be a part of the Industrial Automation Division of Emerson Electric Co.

Emerson (NYSE:EMR), based in St. Louis, Missouri (USA), is a global leader in bringing technology and engineering together to provide innovative solutions for customers in industrial, commercial, and consumer markets through its network power, process management, industrial automation, climate technologies, and appliance and tools businesses. For more information, visit www.Emerson.com.

Introduction to Control Technology

Glossary of Terms	2-3
Control Systems / Control Methods	4
Types of Controllers	5

Applications for Proportional Valves

For Economical Quality and Control	6
Application Examples	7-9

Selection of Proportional Valves

Technical Characteristics	10
Choice of Equipment	11

Pressure Control

608/609 Series SENTRONIC ^P / Technical Characteristics	12-18
614 Series SENTRONIC ^{PLUS} / Technical Characteristics	19-23
616 Series SENTRONIC ^{HD} / Technical Characteristics	24-27
605 Series PULSTRONIC II	28-31
615 Series SERVOTRONIC ^{DIGITAL}	32-35
E Series / Technical Characteristics	36-41



Flow Control

607 Series FLOWTRONIC ^P / Technical Characteristics	42-47
--	-------



Accessories

603 Series CONTROL ^D / Technical Characteristics	48-52
---	-------



G3 Fieldbus High Current Analog Module Information



Symbols and Terminology

Glossary of Terms

Hysteresis

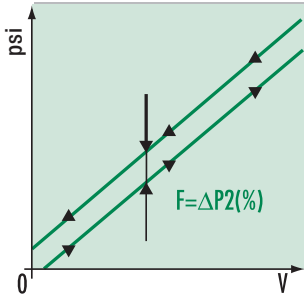

Hysteresis is the tolerance of the outlet pressure for a given command signal depending on whether the previous pressure was higher or lower.

Symbols

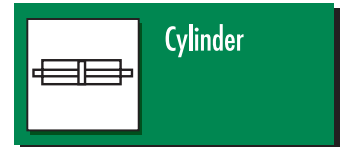
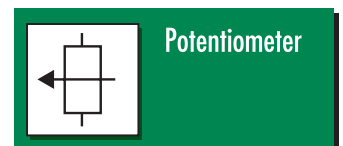
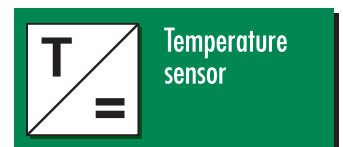
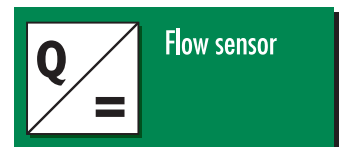
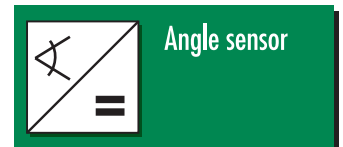

Sensitivity

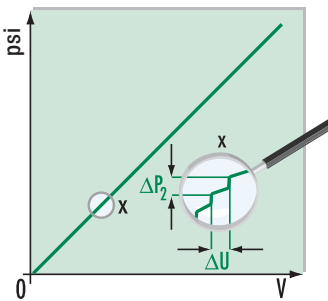

The smallest change in command signal which leads to a change in the outlet pressure is called sensitivity. Expressed as a percentage of the maximum outlet pressure.

Linearity

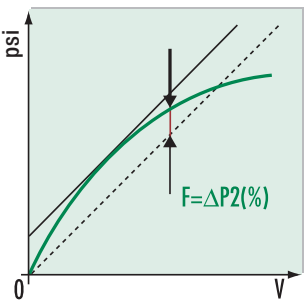

The ideal relationship between command signal and outlet pressure is linear, and when plotted results in a straight line (dotted line). Linearity is a measure of the maximum deviation between the actual outlet pressure and commanded pressure.

Repeatability

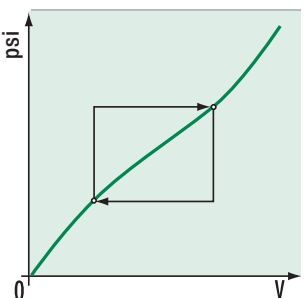

Repeatability is the tolerance of the outlet pressure for the same command signal given multiple times.



Trimming potentiometer

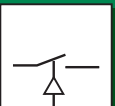

Electrical switch



Digital display



Analogue display



Tachometer generator



Proportional valve



Voltage / current selector



Digital-to-analogue converter

Zero Adjustment

The pressure or flow that corresponds with the lowest command signal.

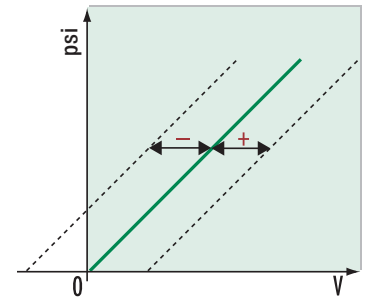

Span Adjustment

The valve's output pressure or flow range can be reduced to match the application's needs, providing the highest possible resolution.

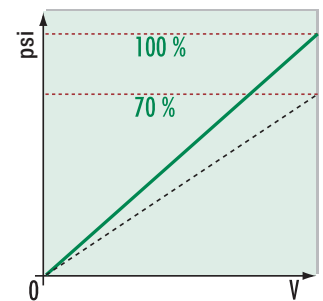

Ramp Function

The ramp function transforms a command signal step into an internal gradual increase. This allows slow opening and closing of proportional valves.

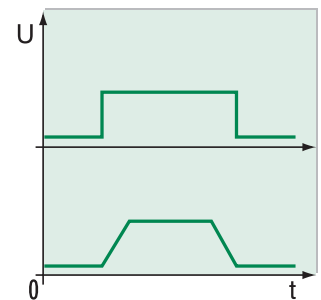

Ripple Frequency

Modulation voltage to minimize friction (slip-stick) in a valve.

Feedback Value

Actual electrical value of a physical variable. (Pressure, force, temperature, flow, etc.)

Control Systems

Within industrial automation, the goal of a control system is to move a physical variable such as temperature, pressure, force or displacement to a predetermined value. The complexity of the system, impact of external variables and required accuracy will dictate whether the control system needs some type of feedback measurement in order to ensure that the desired value (or setpoint) is reached. The difference between open-loop and closed-loop control is that the feedback allows the control system, or control loop, to compare the output to the commanded value and adjust as needed.

Open-Loop Control

An example of an open control loop is a timer for a sprinkler system. When the timer is activated, the sprinkler goes on for a set amount of time. This is open-loop control because the system does not monitor, for instance, the moisture content of the soil. The system will turn the sprinklers on in the middle of a rainstorm. The desired outcome of the controlled action is not monitored.

An open sequence of actions where there is no comparison of the end result to the desired result is the primary characteristic of open-loop control.

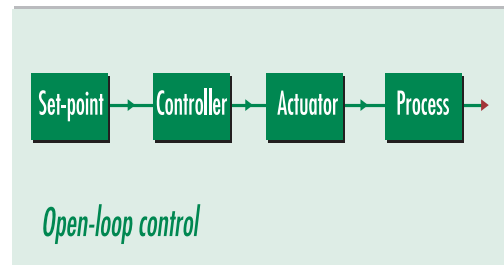

Closed-Loop Control

In a closed loop, the desired value or setpoint is constantly compared to the actual value. DIN standard 19226 defines the terms “Control and Adjustment” as follows: “Control and adjustment is an operation in which a physical variable (e.g. temperature, pressure etc.) is continuously measured and compared to a previously specified value of the variable with the aim of matching the two. The resulting closed sequence of actions occurs in a closed loop, the closed-control loop.”

In the example of the sprinkler system, the actual moisture content of the soil could be measured with a sensor and compared to the desired moisture level. As soon as there is a difference between the desired value and measured value, a signal can be sent to either open the water valve (if the soil is dryer than specified) or close the valve (if the soil is wetter than specified). The feedback, provided by the sensor in this case, that is used to compare and adjust the actual value to the desired value is the primary characteristic of a closed-loop system.

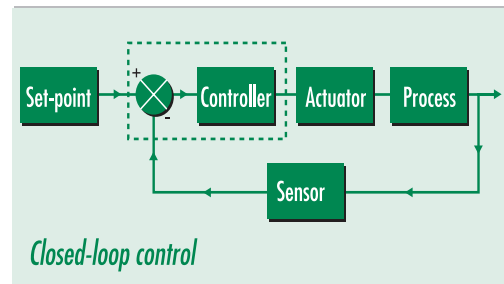

Types of Controllers

A controller is a transfer element which compares the feedback value received from a transducer (sensor) to a predetermined value (i.e. setpoint) and processes it in such a way that a control signal is transmitted to the actuating element (e.g. a proportional valve). The controller should control this transmission in such a way that the dynamic qualities of the controlled process are balanced. The setpoint should be reached quickly while the feedback value should fluctuate as little as possible around the setpoint.

Numatics' proportional valves use a common controller called a proportional-integral-derivative (PID) controller. The P, I and D terms can easily be modified with each product's software to achieve various types of control based upon the needs of a given application. The most basic controller is the P controller. P, PI and PID control are best suited to a wide range of applications.

The charts to the right show graphical representations of the various PID terms and the table below shows the types of controllers that are most often successful by application.

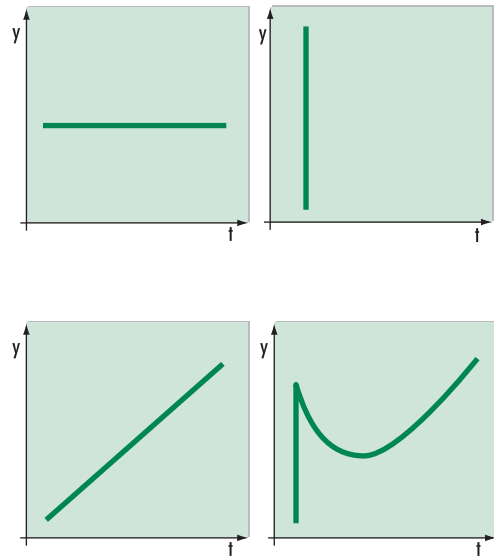

Application	Types of controllers		
	P	PI	PID
Pressure	low profile	suitable	suitable
Flow	unsuitable	suitable	less suitable
Temperature	low profile	suitable	suitable
Level	suitable	unsuitable	unsuitable
Speed	suitable	suitable	suitable

For Economical Quality and Control...

Proportional valves maximize production processes in many industries including food processing, textiles, industrial plant engineering, medical technology, pharmaceutical, semiconductor, and automobile. These valves create many innovative solutions when incorporated into a programmable control system. The combination of electronics and mechanics in proportional valves provides ideal performance for many industrial applications. Numatics' proportional pressure regulators and flow control valves are highly customizable to specific applications. Numatics continually develops customized components and solutions for specific customer requirements. Please do not hesitate to contact Numatics' technical support team.

Spot Welding

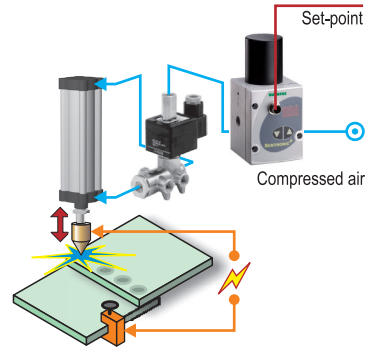

The proportional pressure regulator controls the clamping force of the welding head depending on the material to be welded and its thickness.

Compensation of Thickness

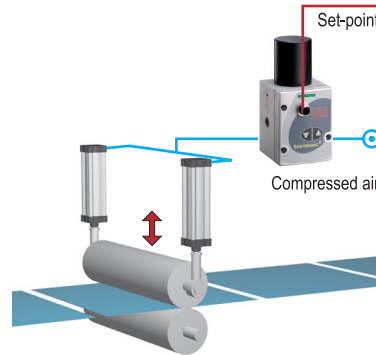

The pressure acting against the roller is controlled with a proportional pressure regulator. Different thickness in the materials is offset.

Servo Unit for Brakes

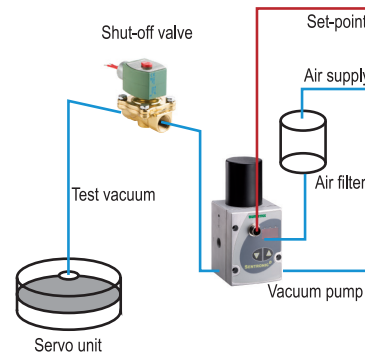

The proportional pressure regulator is incorporated in the bypass of a vacuum pump. The brake booster is checked against the setpoint.

Force

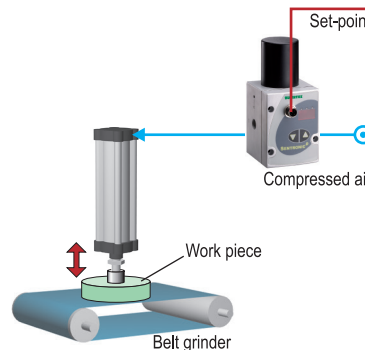

The proportional valve controls the force acting against work pieces on grinding belts, pneumatic presses etc.

Control of Pressure and Flow

Paint Spray Gun Application

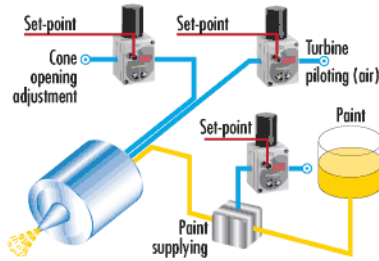

Spray gun control: Control of paint flow and spray density, and of the surface of the part of being painted.

Glue Dosing

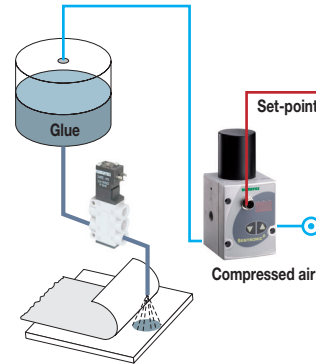

The proportional pressure regulator maintains system pressure as the level of glue in the container decreases. Glue is dosed accordingly.

Material Testing

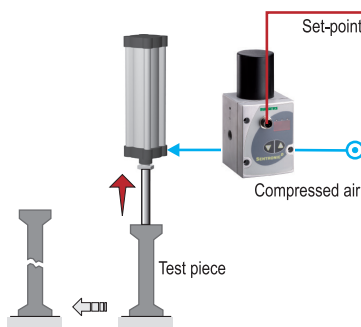

The force acting against the test piece is continuously increased until the test piece is destroyed.

Vacuum Generation

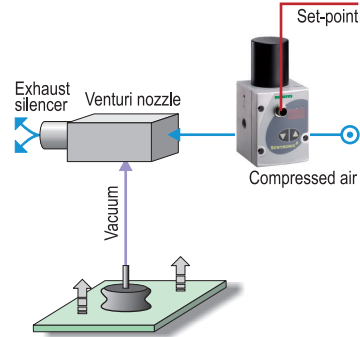

A change of pressure into the venturi nozzle via the proportional valve changes the vacuum generated.

Fluid Coating

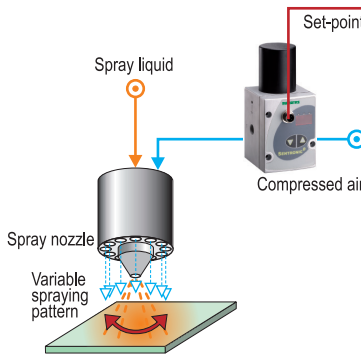

The spray pattern, i.e. the coating width, is adjusted by controlling the air supply through fan adjusting nozzles.

Flight Simulator

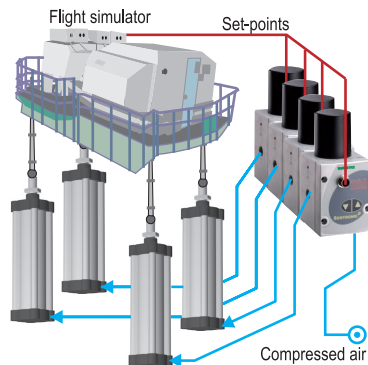

The movements of an aircraft are simulated by applying different pilot pressures to the cylinders.

Brake Pressure

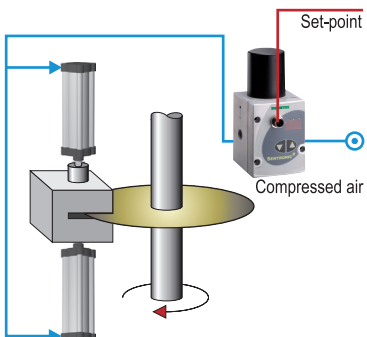

A command signal is used to gradually brake and slow down a rotating mass in accordance with the controller's speed profile.

Leak Test

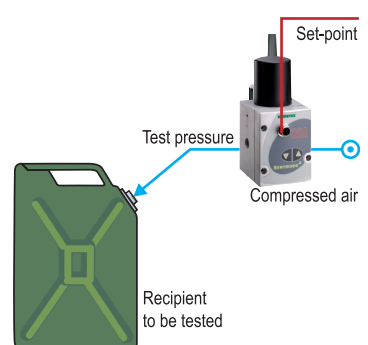

The proportional pressure regulator precisely adjusts the test pressure for different leak tests.

Control of Pressure and Flow

Laser Cutting

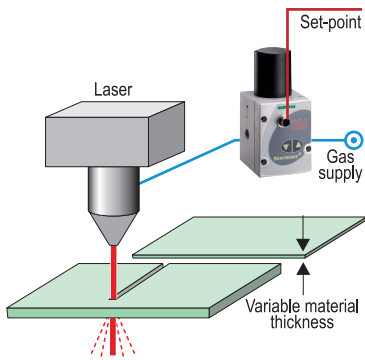

The gas pressure is adjusted in accordance with the material and its thickness.

Ultrasonic Welding

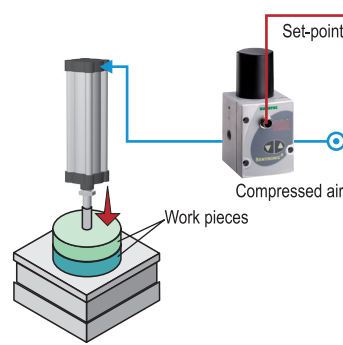

The proportional pressure regulator adjusts the frictional pressure of ultrasonic welding machines.

Bottle Molding

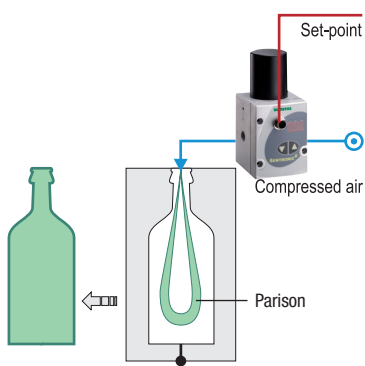

The parison is inflated at a varying rate using a proportional valve.

Turbo-Supercharger

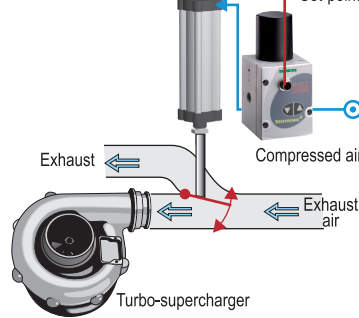

Exhaust gas flow is adjusted to the turbo-supercharger depending on the engine speed to maintain the charging pressure at a constant level.

Dual Loop Control

Sentronic^D, Sentronic^{PLUS} and Flowtronic^D can be configured for dual loop control. Process variables such as pressure, flow, force, speed, RPM, and temperature can be controlled. Dual loop control requires no additional components other than a process sensor to provide an analog feedback input.

Control of Speed and Torque

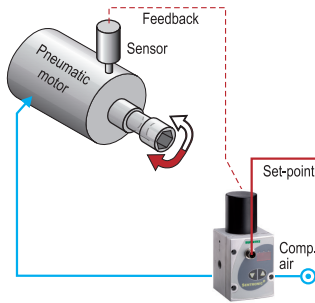

Speed and torque are controlled by changing the pilot pressure.

Tire Making

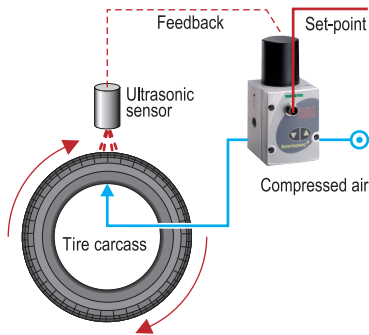

Controlled by the proportional pressure regulator with a dependence on the tire's diameter, the individual plies of the tires are built up and a constant tire quality is ensured.

Filling Pressure

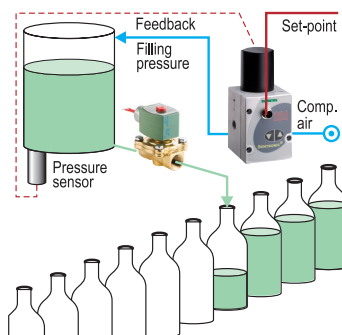

The liquid flows to the valve at a constant pressure irrespective of the fluid level in the storage tank. The filling volume remains constant.

Flow Control

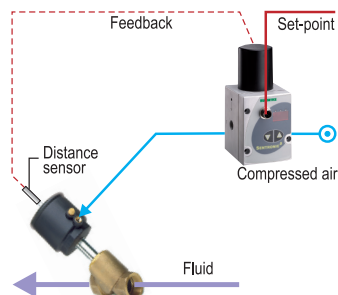

The flow of liquids is varied by continually adjusting the orifice of the fluid valve by measuring the valve's travel (distance sensor).

Compensation of Lengths in Winding

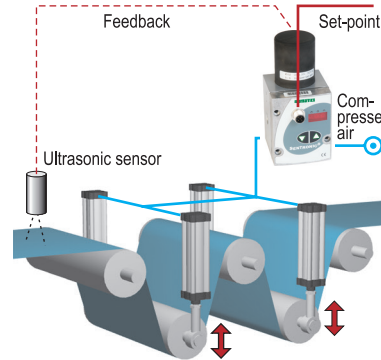

Different lengths of winding material are offset with cylinders controlled by proportional pressure regulators, which controls the tensile stress.

Balancer

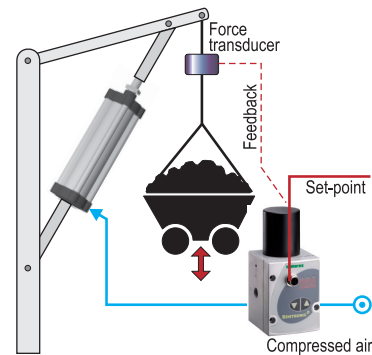

The proportional valve pneumatically balances the weight over the cylinder pressure. Heavy loads can easily be lifted and lowered by hand.

Temperature Control

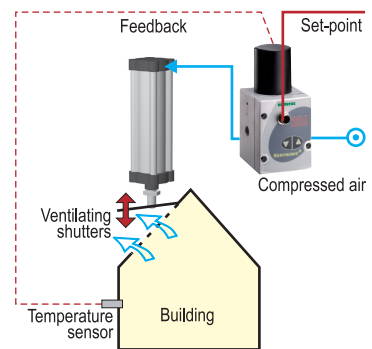

The room temperature is held at a constant level by opening or closing ventilating shutters.

Clamping Pressure Control

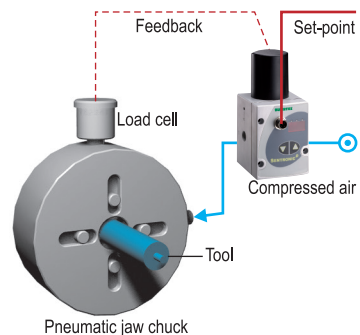

The clamping pressure of machine tools is adjusted in accordance with the tool's material (steel, synthetic material, etc.).

Technical Characteristics



	Port size	Pilot pressure	Pressure range	Flow	Filtration	Hysteresis	Power rating	Type of construction	Loss of power behavior
SENTRONIC^D	1/8, 1/4, 3/8 NPT or GTap	-	0 to 150 psi 0 to 10 bar	up to 45.9 SCFM 1300 NI/min	50 µm	< 1%	21 to 40 W	Poppet valve	Pressure released
SENTRONIC^{PLUS}	1/8, 1/4, 1/2, 1 NPT or GTap	-	0 to 725 psi 0 to 50 bar	up to 197.8 SCFM 5600 NI/min	50 µm	< 1%	33 to 44 W	Poppet valve	Pressure released
PULSTRONIC II	1/4 NPT or GTap	-	0 to 150 psi 0 to 10 bar	17 SCFM 470 NI/min	50 µm	< 1%	3.6 W	Pilot + Poppet valve	Pressure held
E22	1/4, 3/8, 1/2, NPT, GTap or BSPT	-	0 to 150 psi 0 to 10.2 bar	up to 100 SCFM 2800 NI/min	5 µm	< 1%	1 W	Pilot + Poppet valve	Pressure held
SERVTRONIC^{DIGITAL}	G 3/8	-	0 to 580 psi 0 to 40 bar	60 SCFM 1700 NI/min	5 µm	< 0.5%	28 W	Spool-Sleeve Assembly	Pressure released
FLOWTRONIC^D	1/4, 3/8, 1/2 NPT or GTap	-	58 to 116 psi 4 to 8 bar	0.4 to 35.3 SCFM 10 to 1000 NI/min	50 µm	< 3%	33 to 44 W	Poppet valve	Pressure released

Choice of Equipment



		Control		Fluids			Control loop		Actuation		Application		Special features	
		Pressure	Flow	Vacuum	Air/neutral gases	Liquids	Steam	open	closed	electrical	air piloted	static		dynamic
	SENTRONIC ^D	●	○		●				●	●		■	▲	Digital control with or without display, controller adaptation
	SENTRONIC ^{PLUS}	●	○	●	●				●	●		■	▲	Digital control with or without display, controller adaptation
	PULSTRONIC II	●	○		●				●		●	■		Digital control with or without display, controller adaptation
	E SERIES	●	○		●				●		●	■		Optional 2 bit binary digital
	SERVTRONIC ^{DIGITAL}	●	○		●				●	●		■	▲	Digital control, controller adaptation
	FLOWTRONIC ^D		●		●				●	●		■	▲	Digital control with or without display, controller adaptation



Sentronic^D

Sentronic^D is a digitally operated pressure regulator valve.

Sentronic^D stands for:

- Digital control
- Display (integrated)
- Direct operated valve

With the Data Acquisition Software (DaS) and the RS232 interface, it's now possible to optimally adjust the valve's control parameters to a specific application. The scope function allows you to log and read the system's response in real time.

The DaS capabilities streamline the development process and identify application-specific problems at an early stage. Saved parameters can also be used for future production so that valves are factory-set to a specific application.

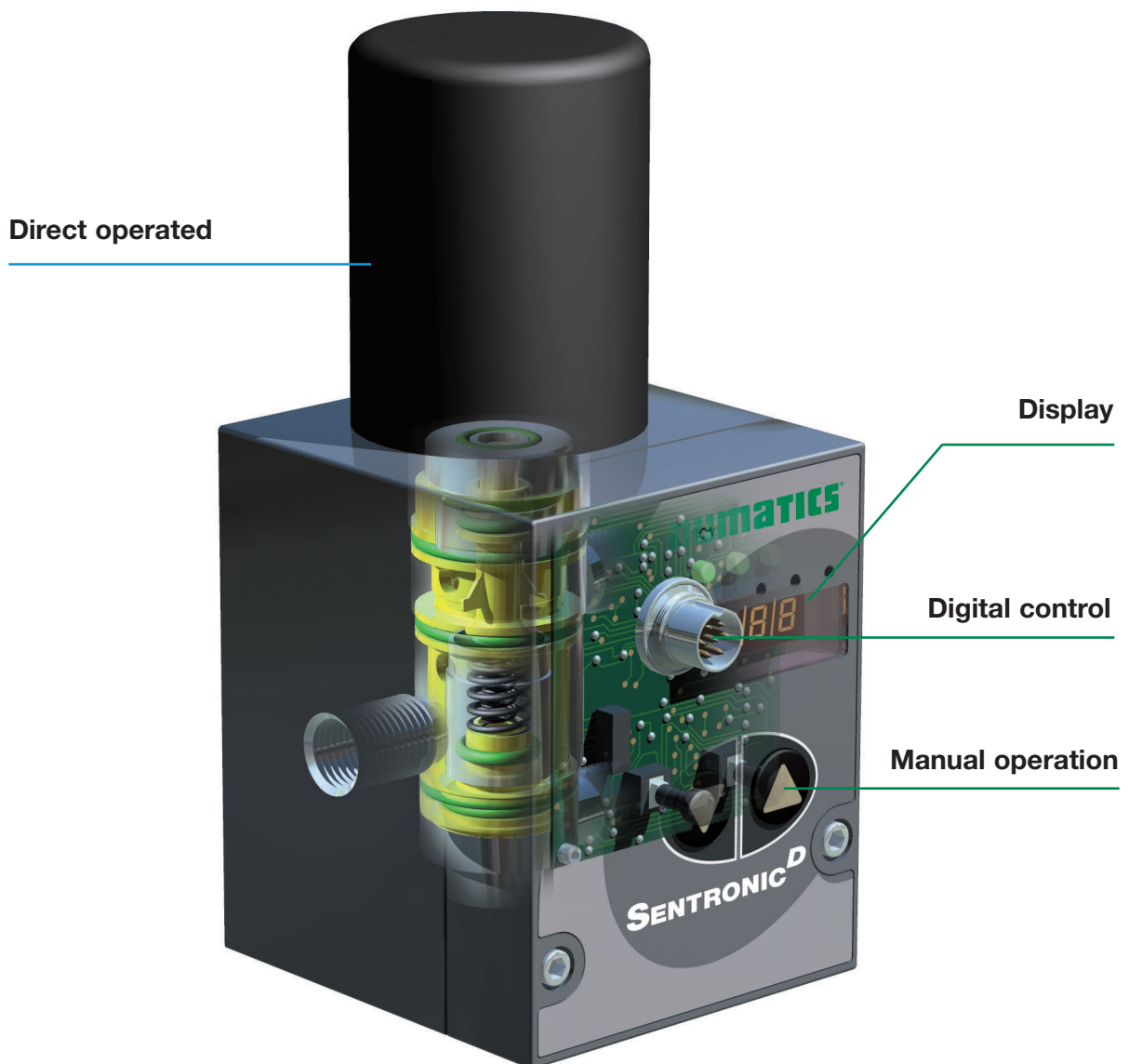



Step test function

Parameters setup

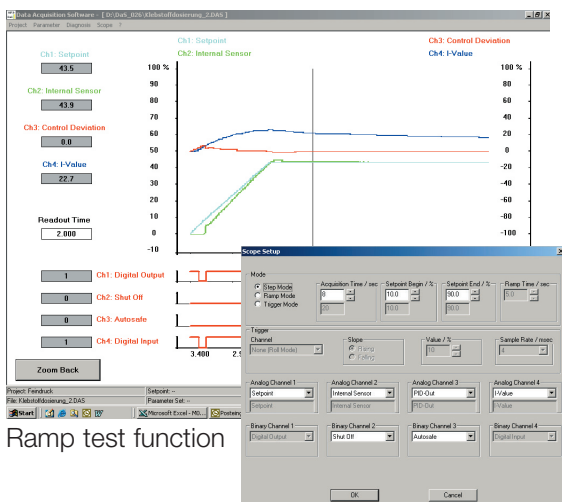

Ramp test function

Scope setup

Advantages

- Minimum hysteresis
- Quick response times
- Very high sensitivity
- Standard 50 µm filtration
- No constant air consumption
- Analog feedback output
- Easy change of control parameters
- Digital control
- Integrated display (optionally without)
- PC communication

Specifications

Fluids: Air or neutral gases
 Pressure Range: 0 - 50 psi,
 0 - 100 psi, 0 - 150 psi, 0 - 3
 bar, 0 - 6 bar, 0 - 10 bar
 Ports: 1/8, 1/4, 3/8 (NPT
 or GTap)
 Construction: Poppet Valve
 Actuation: Proportional Solenoid
 Command Signal: 0 - 10 V,
 0 - 20 mA, 4 - 20 mA

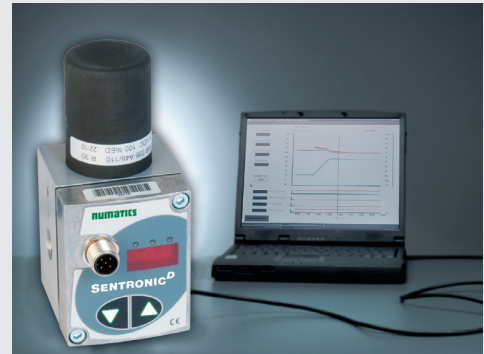

By connecting the Sentronic^D to a PC with an RS232 interface, the Data Acquisition Software (DaS) can be used to optimally adjust the valve's control parameters to a specific application. DaS has an oscilloscope function that allows the user to select and visually see various response characteristics as the valve operates in an application. Control loop parameters can be adjusted using the software without removing the valve from service. This functionality streamlines the application development process. Control parameters can be saved and reloaded at any time.

The DaS software offers the following features:

- Real time display of: command signal, outlet pressure, internal control parameters (e.g. P, I or D), pressure switch signal, etc.
- Parameter setting: command signal, zero offset, span, limitation of output current, ramp function, etc.
- Diagnostics menu for error detection and testing
- Custom adjustment to an application
- Control of Sentronic^D

Sentronic^D

1/8 to 3/8 tapped body or 1/8 - 1/4 sub-base mounted body (NPT or GTap)



Features

- Sentronic^D is a highly dynamic 3-way proportional valve with digital control.
- Sentronic^D stands for:
 - Digital communication and control
 - Display (integrated)
 - Direct operated valve
- A special feature of the Sentronic^D is its DaS software supplied for optimum adjustment via PC and viewing of command and feedback signals.
- Other functions are valve diagnostics, parameter setting and maintenance.
- Sentronic^D can be configured for dual loop control of process variables such as flow, force, speed, RPM and temperature.

Construction

Body: Aluminum
 Internal parts: POM (polyacetal)
 Seals: NBR (nitrile) and FPM (fluoroelastomer)

General

Fluids: Air or neutral gas, filtered at 50 µm, condensate-free, lubricated or unlubricated
 Maximum allowable pressure (MAP): 90 to 190 psi (6 to 13 bar)
 Pressure range: 0-50 psi to 0-150 psi (0-3 bar to 0-10 bar)
 Fluid temperature: 32°F - 140°F (0°C - 60°C)
 Ambient temperature: 32°F - 122°F (0°C - 50°C)
 Flow (Qv at 6 bar): 470 to 1300 l/min (ANR)
 Command signal: 0 - 10 V (impedance 100 kΩ)
 0 - 20 mA / 4 - 20 mA (impedance 250 Ω)
 Hysteresis: < 1% of span
 Linearity: < 0.5% of span
 Repeatability: < 0.5% of span
 Minimum setpoint: 100 mV (0.2 mA/4.2mA) with shut-off function
 Minimum outlet pressure: 1% of span

Electrical Characteristics

Nominal Diameter DN (mm)	Voltage *	Max. Power (W)	Max. Current (mA)	Insulation Class	Degree of Protection	Electrical Connection
4	24 VDC ±10%	21	850	H	IP 65	5-pin M12 connector (not supplied)
8	24 VDC ±10%	40	1650	H	IP 65	5-pin M12 connector (not supplied)

* Max. ripple: 10 %

Specifications

Ø Ports	Ø Orifice DN (mm)	Flow	
		C _v Flow Factor (K _v Nm ³ /h)	at 6 Bar (l/min - ANR)
1/8, 1/4 NPT or GTap	4	0.29 (0.25)	470
1/4, 3/8 NPT or GTap	8	0.81 (0.7)	1300

How to Order

608 6 C 0 1 1 1

Nominal diameter
 608 = DN 4mm
 609 = DN 8mm

Version (ports), body
 0 = G 1/8 (DN4), G 1/4 (DN 8)
 1 = G 1/4 (DN 4), G 3/8 (DN 8)
 2 = Manifold version¹⁾
 G 1/8 (DN 4), G 1/4 (DN 8)
 6 = NPT 1/4 (DN 4), NPT 3/8 (DN 8)

Pressure range

Maximum pressure		Maximum pressure	
A = 0 - 50 psi	90 psi	1 = 0 - 10 bar	13 bar
B = 0 - 100 psi	140 psi	2 = 0 - 12 bar	15 bar
C = 0 - 150 psi	190 psi	3 = 0 - 3 bar	6 bar
		4 = 0 - 1 bar	4 bar
		5 = 0 - 15 bar	18 bar
		6 = 0 - 6 bar	9 bar

Options
 A00 = Dual loop control
 211 = Oxygen clean

Display
 0 = without display
 1 = with display

Digital output
 1 = Pressure switch output
 PNP ± 5 %

Feedback
 1 = Feedback output 0 - 10 V
 2 = Feedback output 0 - 20 mA
 3 = Feedback output 4 - 20 mA
 4 = Feedback input 0 ... 10 Volt²⁾
 5 = Feedback input 0 ... 20 mA²⁾
 6 = Feedback input 4 ... 20 mA²⁾

Command signal
 0 = 0 - 10 V
 1 = 0 - 20 mA
 2 = 4 - 20 mA

Notes:
¹⁾ See Accessories section for required manifold sub-base.
²⁾ Feedback input is needed for dual loop units.

Dimensions: Inches (mm), Weight in lbs. (kg)

Inline version: DN 4

Weight: 1.23 (0.56)

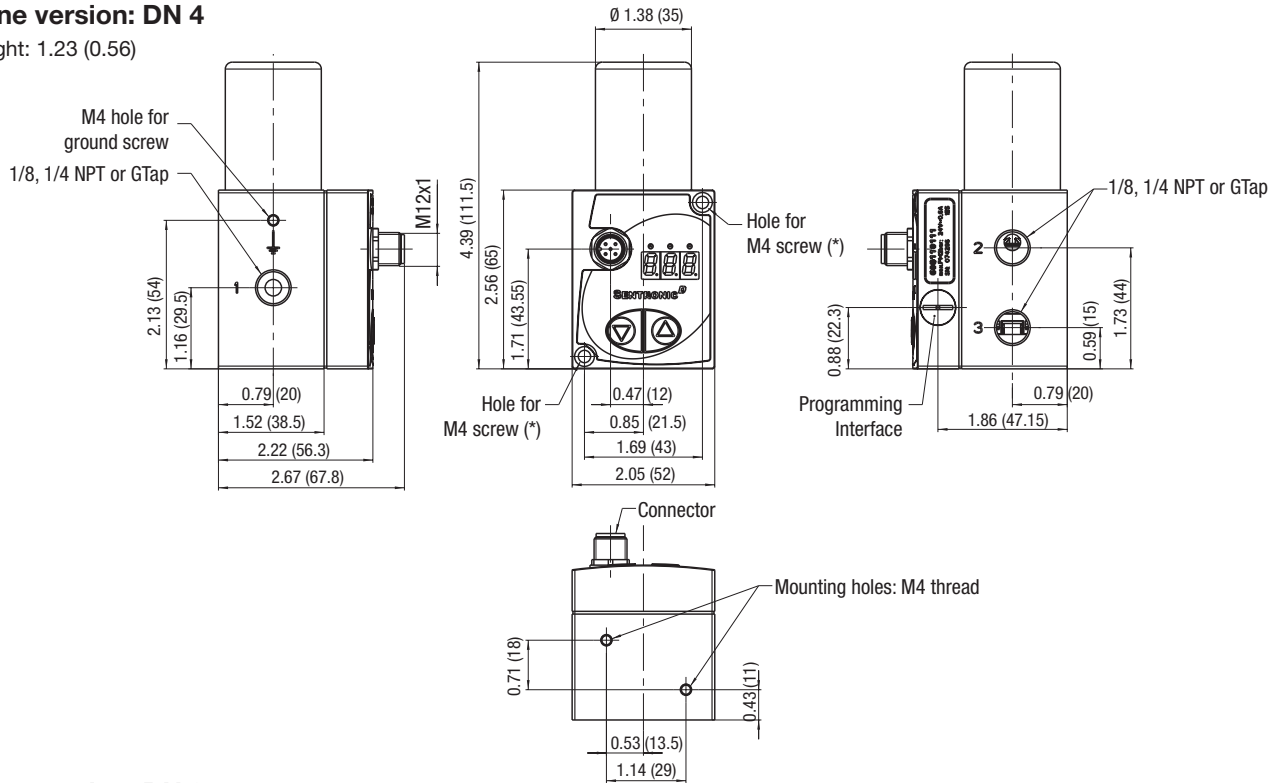

Inline version: DN 8

Weight: 2.49 (1.13)

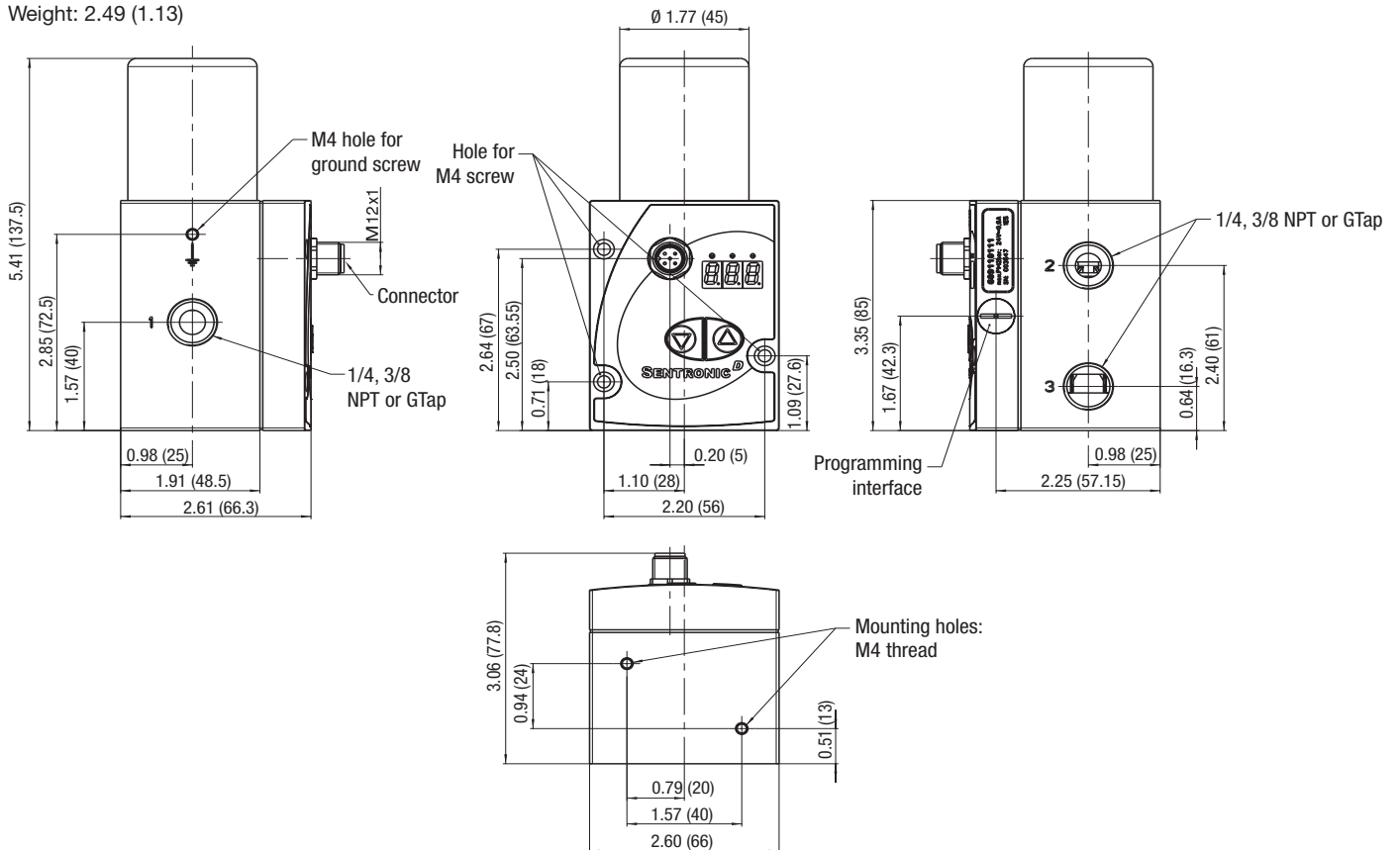

Dimensions: Inches (mm), Weight in lbs. (kg)

Manifold version: DN 4

Weight: 1.23 (0.56)

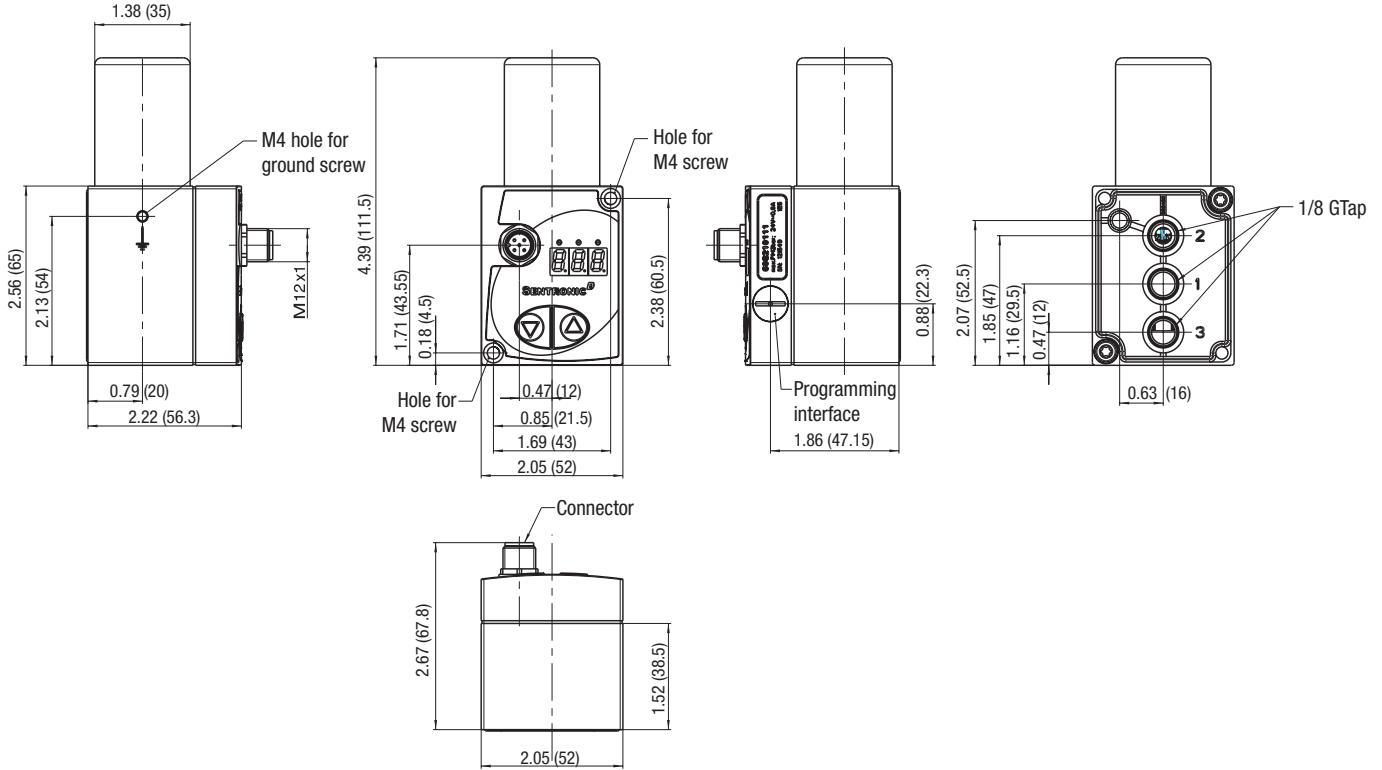

Manifold: DN 4

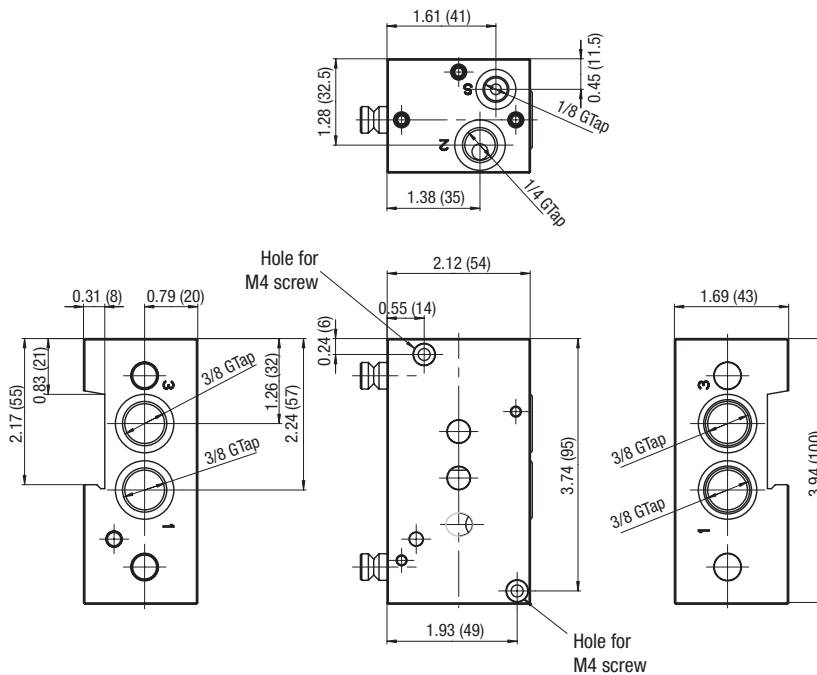

Dimensions: Inches (mm), Weight in lbs. (kg)

Manifold version: DN 8

Weight: 2.49 (1.13)

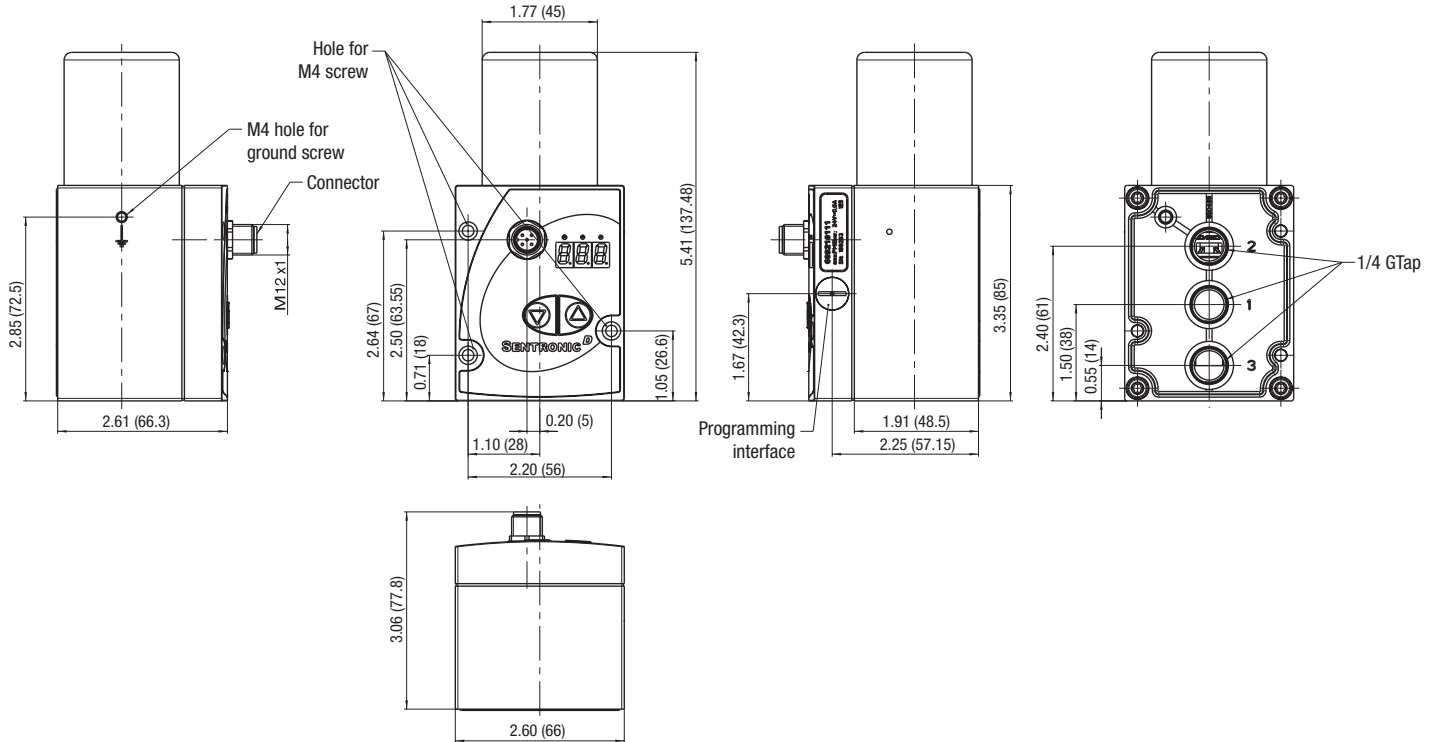

Manifold: DN 8

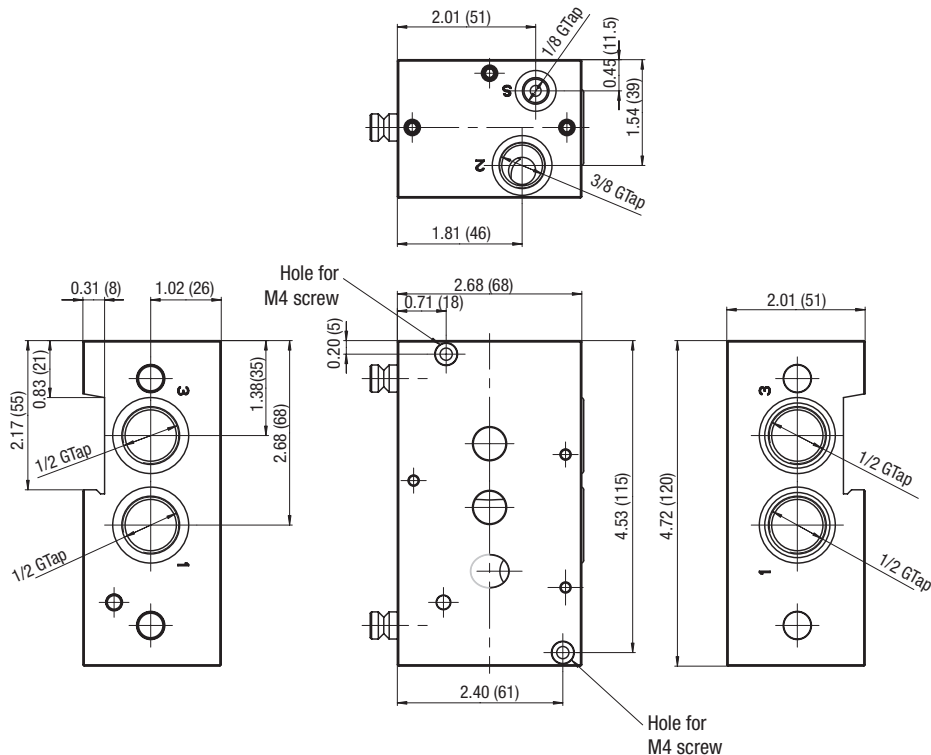

Connector Pin Out

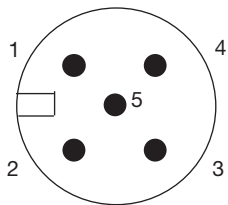

PIN	Description
1	+24 VDC Supply
2	Command Signal
3	+0 VDC Common (Supply)
	+0 VDC Common (Command Signal)*
4	Analog output (feedback)
5	Digital output (pressure switch)
Body	EMC shield

*A 6-wire cable with separate common for the command signal is used for cable lengths over 2 m to minimize the voltage drop for the command signal.

Accessories



5 Pin 12mm FEMALE Straight Field Attachable Connectors		Model Number
PG 9 Cable Gland		TC05F2000000000
5 Pin 12mm FEMALE 90 DEGREE Field Attachable Connectors		Model Number
PG 9 Cable Gland		TD05F2000000000
Micro Female 5 Pole Straight 6 Wire 24 AWG, Shielded		
3 Meter		TC0503MMS000671Y
5 Meter		TC0505MMS000671Y
Micro Female 5 Pole 90 Degree 6 Wire 24 AWG Euro Color Code, Shielded		
3 Meter		TD0503MMS000671Y
5 Meter		TD0505MMS000671Y
Micro F/M 4 Pole Straight 22 AWG Euro Color Code		
Unshielded		Shielded
2 Meter - TC0403MIETA04000		3 Meter - TC0403MMETA04000
5 Meter - TC0405MIETA04000		5 Meter - TC0405MMETA04000
Micro F 90°/M Straight 22 AWG Euro Color Code		
Unshielded		Shielded
2 Meter - TD0403MIETA04000		3 Meter - TD0403MMETA04000
5 Meter - TD0405MIETA04000		5 Meter - TD0405MMETA04000
Manifold		Model Number
Manifold for 608 (DN 4mm) with G3/8; common supply and exhaust ¹⁾		35500558
Manifold for 609 (DN 8mm) with G1/2; common supply and exhaust ¹⁾		35500559
PC Software & Cable Connectors		Model Number
DaS Light: Data Acquisition Software for Sentronic ^D - basic parameters - free download at Numatics.com		99100110
DaS Expert: Data Acquisition Software for Sentronic ^D - full parameters - CD-ROM		99100111
RS 232 cable converter; 2m cable with 9-pin Sub-D (plug connector)		88100732
RS 232 cable converter; 2m cable with 9-pin Sub-D (screw connector)		833-993708

¹⁾ Manifold ships with required hardware and gaskets for connecting manifolds together.

G3 Fieldbus - Electronics Made Easy!

Innovative Graphic Display is used for easy commissioning, visual status & diagnostics.

Commissioning Capabilities

- Set network address (including IP & Subnet mask for Ethernet)
- Set baud rate
- Set auto or manual I/O sizes
- Set fault/idle output states
- Set brightness
- Set factory defaults

Visual Diagnostics

- Shorted and open load detection
- Shorted sensor/cable detection
- Low & missing power detection
- Missing module detection
- Self-test activation
- Log of network errors
- Distribution errors



Graphic Display for configuration & diagnostics



Auto Recovery Module

G3 Fieldbus Communications Electronics

Why use Numatics Fieldbus communication electronics?
Modular Reality...

- No internal wiring simplifies assembly.
- SPEEDCON M12 connector technology allows for fast and efficient 1/2 turn I/O connector attachment.
- Power connector allows output power to be removed while inputs and communication are left active.
- IP65 & IP67 protection
- Up to 1200 Input / 1200 Output capability with one communication node! (Present physical I/O combinations allows 1200 I / 544 O)
- 32 valve solenoids per manifold up to 17 manifolds per communication node!
- One node supports 16 I/O modules – Analog I/O, Digital I/O (NPN & PNP) and Specialty
- Innovative clip design allows easy module removal/replacement without dismantling manifold
- Auto Recovery Module (ARM) protects configuration information during a critical failure. Allows configuration information to be saved and reloaded to replacement module automatically.



Highly Distributable



High Current Analog Module

Supported Protocols

- DeviceNet™
- DeviceNet™ w/QuickConnect™
- DeviceNet™ w/DeviceLogix™
- Ethernet
- PROFIBUS®-DP
- CANopen®
- PROFINET®
- Ethernet POWERLINK®



*** High current analog module**



Controls 2 proportional direct-operated high current valves

Auxiliary power connection

Simple connection for external sensor (one for each output)

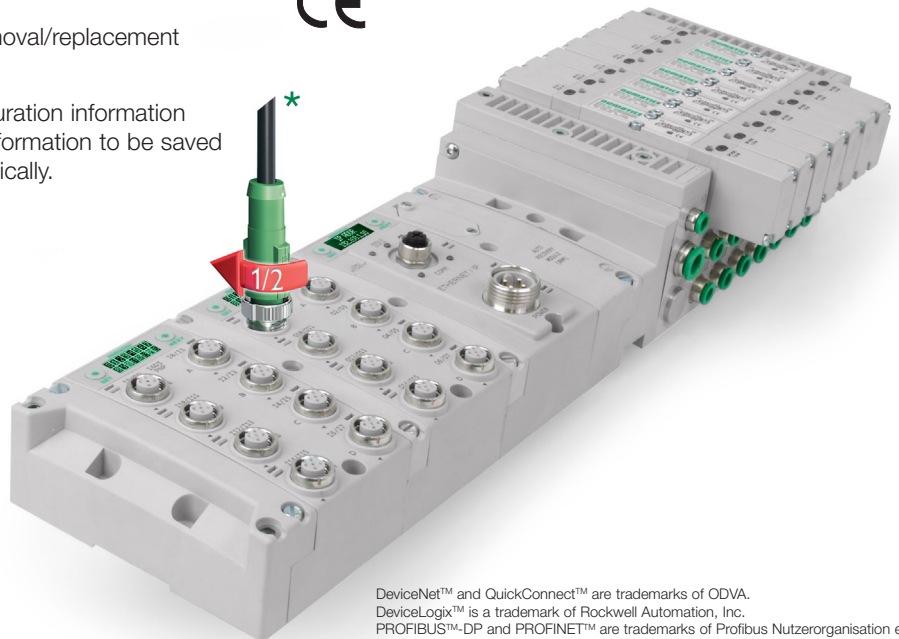

DeviceNet™ and QuickConnect™ are trademarks of ODVA.
DeviceLogix™ is a trademark of Rockwell Automation, Inc.
PROFIBUS™-DP and PROFINET™ are trademarks of Profibus Nutzerorganisation e.V.
Ethernet POWERLINK® is a registered trademark of Bernecker + Rainer Industrie - Elektronik Ges.m.b.H.
CANopen® is a registered Community trademark of CAN in Automation e.V.



World Class Supplier of Pneumatic Components



World Headquarters

USA Numatics, Incorporated

46280 Dylan Drive
Novi, Michigan 48377

P: 248-596-3200
F: 248-596-3201

Canada Numatics, Ltd

P: 519-758-2700
F: 519-758-5540

México - Ascomatica SA de CV

P: 52 55 58 09 56 40 (DF y Area metropolitana)
P: 01 800 000 ASCO (2726) (Interior de la República)
F: 52 55 58 09 56 60

Brazil Ascoval Ind.e Comercio Ltda

P: (55) 11-4195-5333
F: (55) 11-4195-3970