

SERVO VALVES

PILOT OPERATED

FLOW CONTROL VALVE

WITH ANALOG INTERFACE

G771/771 SERIES: ISO 10372-02-02-0-92

G772/772 SERIES: ISO 10372-03-03-0-92

G773/773 SERIES: N06 STANDARD

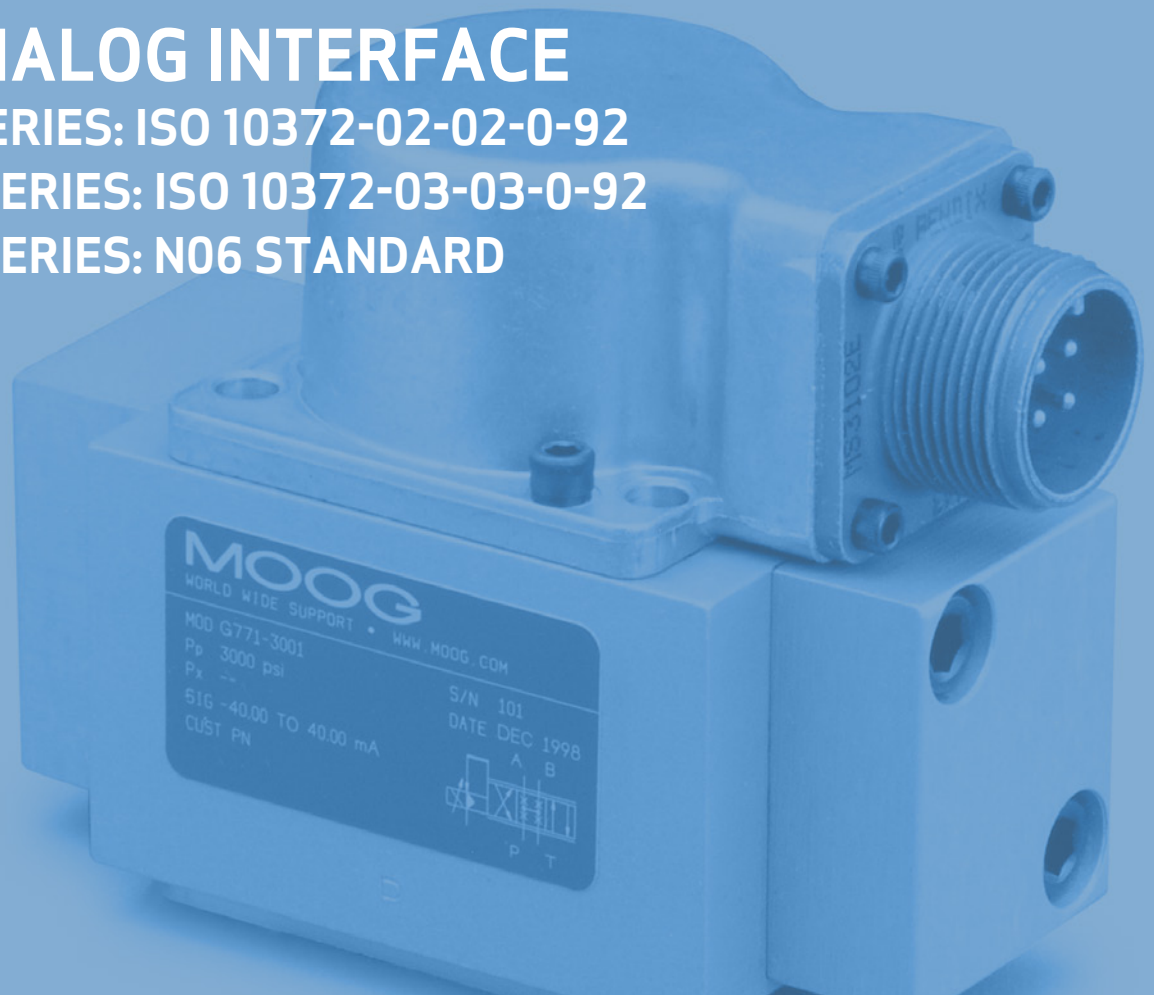

Rev. J, September 2013

HIGH PERFORMANCE, TWO-STAGE DESIGN
PROVIDING FLOW CONTROL IN A SIMPLE
AND DEPENDABLE, LONG-LIFE DESIGN

Whenever the highest levels of motion control performance and design flexibility are required, you'll find Moog expertise at work. Through collaboration, creativity and world-class technological solutions, we help you overcome your toughest engineering obstacles. Enhance your machine's performance. And help take your thinking further than you ever thought possible.

TABLE OF CONTENTS

INTRODUCTION

Product Overview	3
Features and Benefits	4
Description of Operation	5

TECHNICAL DATA

Performance Characteristics	6
Dynamic Characteristics	7
Electrical Data	8
Installation Drawings and Null Adjust Instructions	9
Hole Pattern for Mounting Surface	10

BACKGROUND

Null Flow Adjustment	11
Flow Calculation and Null Cut Options	12
Related Products	13
Routine Maintenance Guidelines	14
About Moog	15

ORDERING INFORMATION

Accessories and Spare Parts	17
Ordering Code	18



This catalog is for users with technical knowledge. To ensure all necessary characteristics for function and safety of the system, the user has to check the suitability of the products described herein. The products described herein are subject to change without notice. In case of doubt, please contact Moog.

Moog is a registered trademark of Moog Inc. and its subsidiaries. All trademarks as indicated herein are the property of Moog Inc. and its subsidiaries. For the full disclaimer refer to www.moog.com/literature/disclaimers.

For the most current information, visit www.moog.com/industrial or contact your local Moog office.

PRODUCT OVERVIEW

The G77X/77X Series flow control servo valves are throttle valves for 3 and preferably 4-way applications. They are a high performance, 2-stage design that covers the range of rated flows from 4 to 57 l/min (1 to 15 gpm) at 210 bar (3000 psi) valve pressure drop per spool land.

The output stage of the valve is a closed center, four-way sliding spool. The pilot stage is a symmetrical double-nozzle and flapper, driven by a double air gap, dry torque motor. Mechanical feedback of spool position is provided by a cantilevered spring. The valve design is simple and rugged for dependable, long life operation.

These valves are suitable for electrohydraulic position, speed, pressure or force control systems with high dynamic response requirements. The G77X/77X is ideally suited for applications where superior dynamics are a must.

Intrinsically safe valve versions are available for use in applications with potentially hazardous environments. Specific models are certified to FM, ATEX, CSA, TIIS and IECEx standards.

	G771/771		G772/772		G773/773
Valve design	2-stage, with spool and bushing and dry torque motor				
Mounting surface	ISO 10372-02-02-0-92	ISO 10372-03-03-0-92	Moog Specific		
Maximum operating pressure	210 bar (3000 psi)				
Maximum Flow	17 l/min (4.4 gpm)	57 l/min (15.0 gpm)	63 l/min (16.5 gpm)		
Pilot stage	Nozzle-flapper				
Rated flow at Δp_n 35 bar / spool land (500 psi /spool land)	4 l/min (1 gpm)	10 l/min (2.5 gpm)	19 l/min (5.0 gpm)	38 l/min (10.0 gpm)	57 l/min (15.0 gpm)
Step response time for 0 to 100 % stroke	4 ms	4 ms	4 ms	10 ms	17 ms



Intrinsically safe valve versions are available for use in potentially hazardous environments. Specific models are certified to FM, ATEX, CSA TIIS and IECEx standards. Contact Moog for details.

FEATURES AND BENEFITS

The G77X/77X Series is proven technology that performs reliably in machines where high performance, stability and accuracy are required. Moog's Mechanical Feedback Valves are designed to provide high reliability and long service life.

Features	Benefits
2-stage design with dry torque motor	Compatibility with many different fluids
Low friction, double nozzle pilot stage	Symmetrical build provides maximum stability over a variety of conditions
High spool control force	Stable consistent flows can be achieved, thus increasing accuracies
High dynamics	Increased production cycles
Rugged, long-life design	Reduced maintenance and down time
High resolution, low hysteresis	Improved accuracies for close tolerance applications
Set up at the factory	Allows easy installation and setup
Intrinsically safe or explosive proof valve versions are environments	Able to be employed in most hazardous environments
Field adjustable null bias	Adjustable for perfect alignment when interchanging equipment
Loss of electrical signal results in a zero position failsafe	Predictable, safe operation

DESCRIPTION OF OPERATION

The G77X/77X Series Flow Control Servo Valve consists of a polarized electrical torque motor and two stages of hydraulic power amplification. The motor armature extends into the air gaps of the magnetic flux circuit and is supported in this position by a flexure tube. The flexure tube acts as a seal between the electromagnetic and hydraulic sections of the valve. The 2 motor coils surround the armature, one on each side of the flexure tube.

The flapper of the first stage hydraulic amplifier is rigidly attached to the midpoint of the armature. The flapper extends through the flexure tube and passes between 2 nozzles, creating two variable orifices between the nozzle tips and the flapper. The pressure controlled by the flapper and nozzle variable orifice is fed to the end areas of the second stage spool.

The second stage is a conventional four-way spool design in which output flow from the valve, at a fixed valve pressure drop, is proportional to spool displacement from the null position. A cantilevered feedback spring is fixed to the flapper and engages a slot at the center of the spool. Displacement of the spool defects the feedback spring which creates a force on the armature/flapper assembly.

Input signals induce a magnetic charge in the armature and cause a deflection of the armature and flapper. This assembly pivots about the flexure tube and increases the size of one nozzle orifice and decreases the size of the other.

This action creates a differential pressure from the one end of the spool displacement causing a force in the feedback wire which opposes the original input signal torque. Spool movement continues until the feedback wire force equals the input signal force.

Electro-hydraulic Servo Valve Cut-away

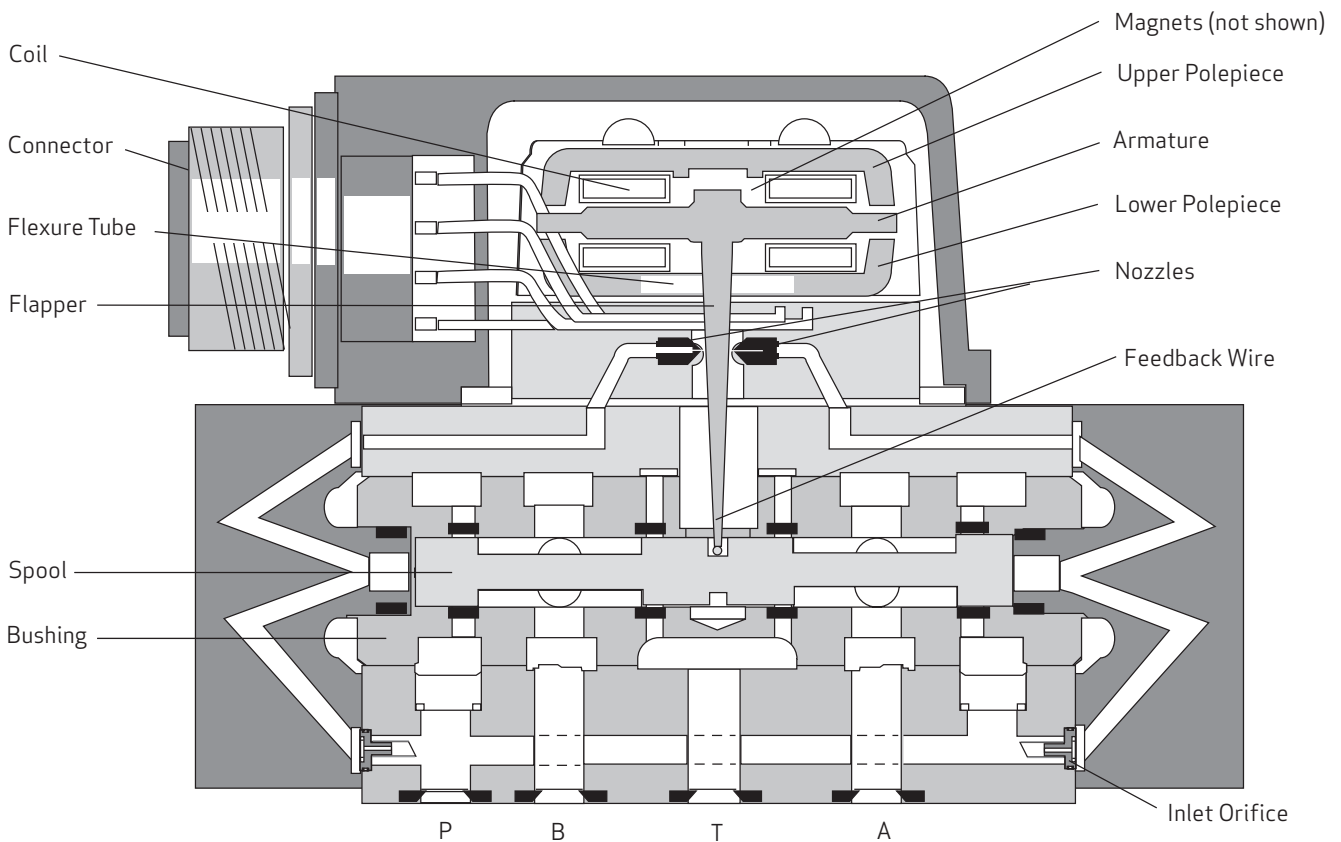

G77X/77X SERIES SERVO VALVES

General Technical Data

Valve design	2-stage, with spool and bushing
Pilot valve	Nozzle Flapper
Mounting surface	G771/771 – ISO 10372-02-02-0-92 G772/772 – ISO 10372-03-03-0-92 G773/773 – Moog specific
Installation position	Any orientation, fixed or movable
Weight	0.86 kg (1.9 lb)
Storage temperature range	-40 to +60 °C (-40 to +140 °F)
Ambient temperature range	-40 to +135 °C (-40 to +275 °F)
Vibration resistance (general)	30 g, 3 axis, 10 Hz to 2 kHz
Shock resistance (general)	30 g, 3 axis
Seal material	Fluorocarbon (FKM) 85 SHORE Others upon request

Hydraulic Data

Maximum operating pressure	
Ports P, A and B	210 bar (3,000 psi)
Port T	210 bar (3,000 psi)
Rated flow at Δp_N 35 bar/spool land (500 psi/spool land)	4/10/19/38/57 l/min (1/2.5/5/10/15 gpm)
Maximum flow	
G771/771	17 l/min (4.4 gpm)
G772/772	57 l/min (15 gpm)
G773/773	63 l/min (16.5 gpm)
Maximum main stage leakage flow rate (\approx zero lap)	1.9 l/min (0.49 gpm)
Null adjust authority	Greater than 10% of rated flow
Hydraulic fluid	Hydraulic oil as per DIN 51524 parts 1 to 3 and ISO 11158 Other fluids on request
Temperature range	-40 to +60 °C (-40 to +140 °F)
Recommended viscosity range	10 to 97 mm ² /s (cSt) @ 38 °C
Maximum permissible viscosity range	5 to 1,250 mm ² /s (cSt) @ 38 °C
Recommended filter rating	
For functional safety	β_{10} 75 (10 μ m absolute)
For longer life	β_5 75 (5 μ m absolute)

Static and Dynamic Data

Rated flow	4 l/min (1 gpm)	10 l/min (2.5 gpm)	19 l/min (5 gpm)	38 l/min (10 gpm)	57 l/min (15 gpm)
Deviation of rated flow	\pm 10% of rated flow				
Step response time 0-100% stroke	4 ms	4 ms	4 ms	10 ms	17 ms
Threshold	\leq 0.5% of rated signal				
Hysteresis	\leq 3.0% of rated signal				
Null shift for ΔT - 38°C (100°F)	\leq 2.0% of rated signal				

G77X/77X SERIES SERVO VALVES -STANDARD RESPONSE SERVO VALVES

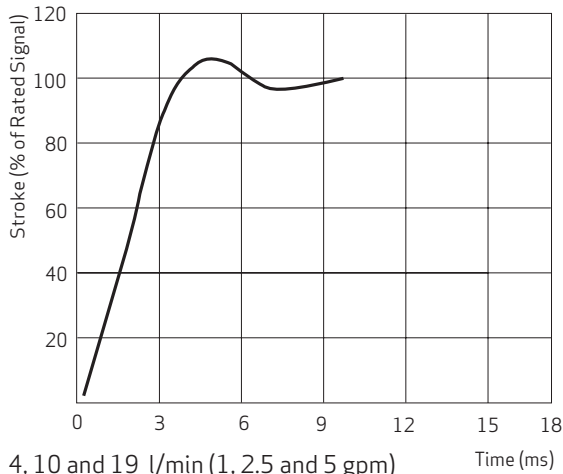

4, 10 and 19 l/min (1, 2.5 and 5 gpm)
Plot @ 210 bar (3,000 psi)

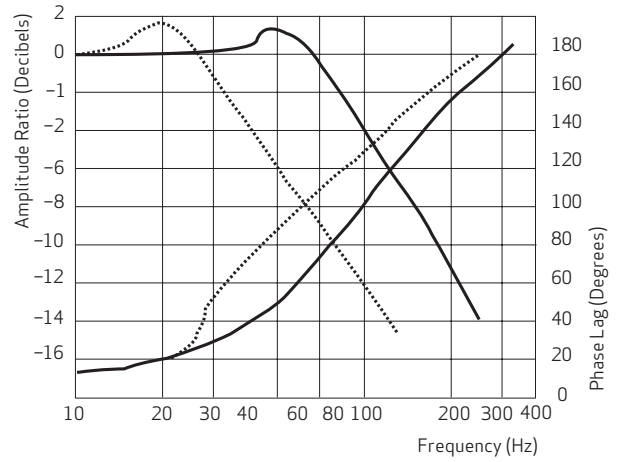

4, 10 and 19 l/min (1, 2.5 and 5 gpm)
Plot 1 & 3 = ±40% rated signal (solid)
Plot 2 & 4 = ±100% rated signal (dash)

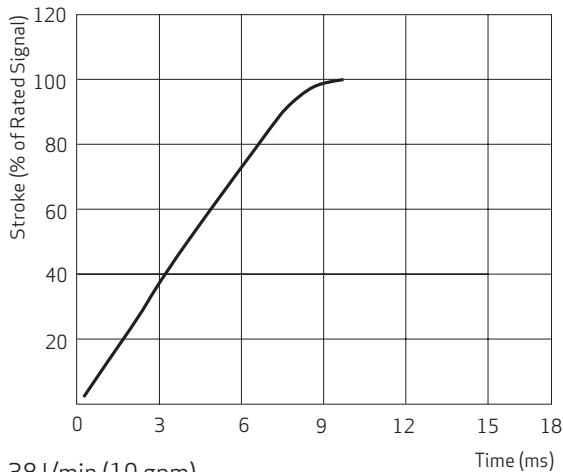

38 l/min (10 gpm)
Plot @ 210 bar (3,000 psi)

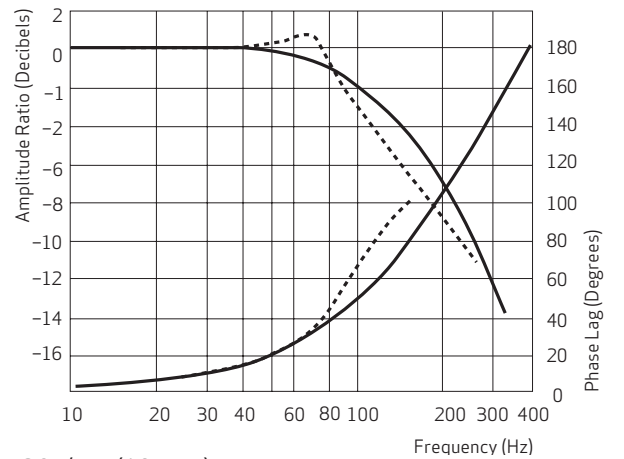

38 l/min (10 gpm)
Plot 1 & 3 = ±40% rated signal (solid)
Plot 2 & 4 = ±100% rated signal (dash)

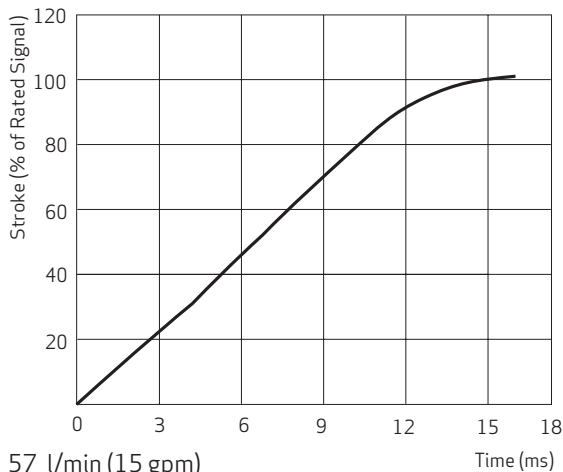

57 l/min (15 gpm)
Plot @ 210 bar (3,000 psi)

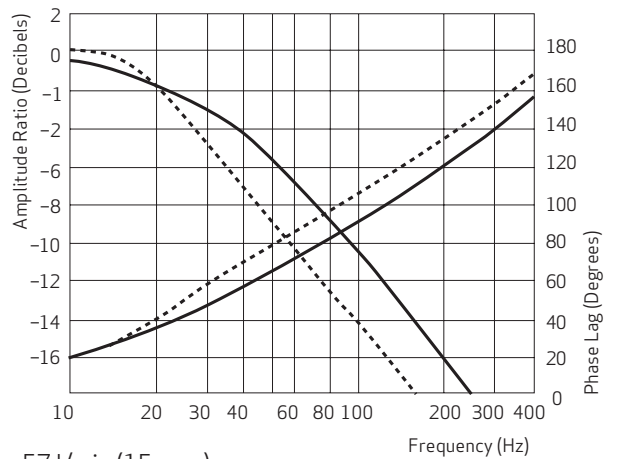

57 l/min (15 gpm)
Plot 1 & 3 = ±40% rated signal (solid)
Plot 2 & 4 = ±100% rated signal (dash)

ELECTRICAL DATA

Rated current and coil resistance

A variety of coils are available for G77X/77X Series Servo Valves, which offer a wide choice of rated currents.

Coil impedance

The resistance and inductance of standard coils are given below. The 2 coils in each Servo Valve are wound with equal turns giving a normal production tolerance on coil resistance of $\pm 1.2\%$. Copper magnet wire is used, so the coil resistance will vary significantly with temperature. The effects of coil resistance changes can be essentially eliminated through use of a current feedback servoamplifier having high output impedance.

Inductance is determined under pressurized operating conditions and is greatly influenced by back electromagnetic forces of the torque motor. These effects vary with most operating conditions, and vary greatly with signal frequencies above 100 Hz. The apparent coil inductance values given are determined at 50 Hz.

Ordering code	Recommended rated current [mA] Command signal			Coil resistance [ohms/coil at 25 °C (77 °F)]	Power consumption [W]		
	Single coil	Series coil	Parallel coil		Single coil	Series coil	Parallel coil
H	± 15	± 7.5	± 15	206	0.045	0.023	0.023
L	± 40	± 20	± 40	80	0.128	0.064	0.064

Ordering code	Recommended rated current [mA] Measured at 50 Hz		
	Single coil	Series coil	Parallel coil
H	0.72	2.2	0.59
L	0.22	0.66	0.18

Coil connections

A 4-pin electrical connector that mates with an MS3106F14S-2S is standard. All 4 torque motor leads are available at the connector so that external connections can be made for series, parallel, or differential operation. G77X/77X Series Servo Valves can be supplied on special order with other connectors or pigtail.

Configuration for valve opening P \rightarrow B, A \rightarrow T

Single

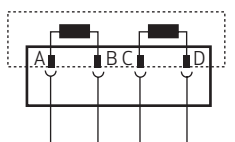

A (+), B (-) or C (+), D (-)

Series

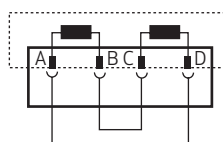

A (+), D (-), B and C connected

Parallel

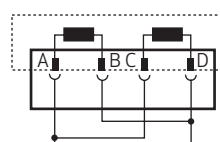

A and C (+), B and D (-)

INSTALLATION DRAWINGS AND NULL ADJUST INSTRUCTIONS

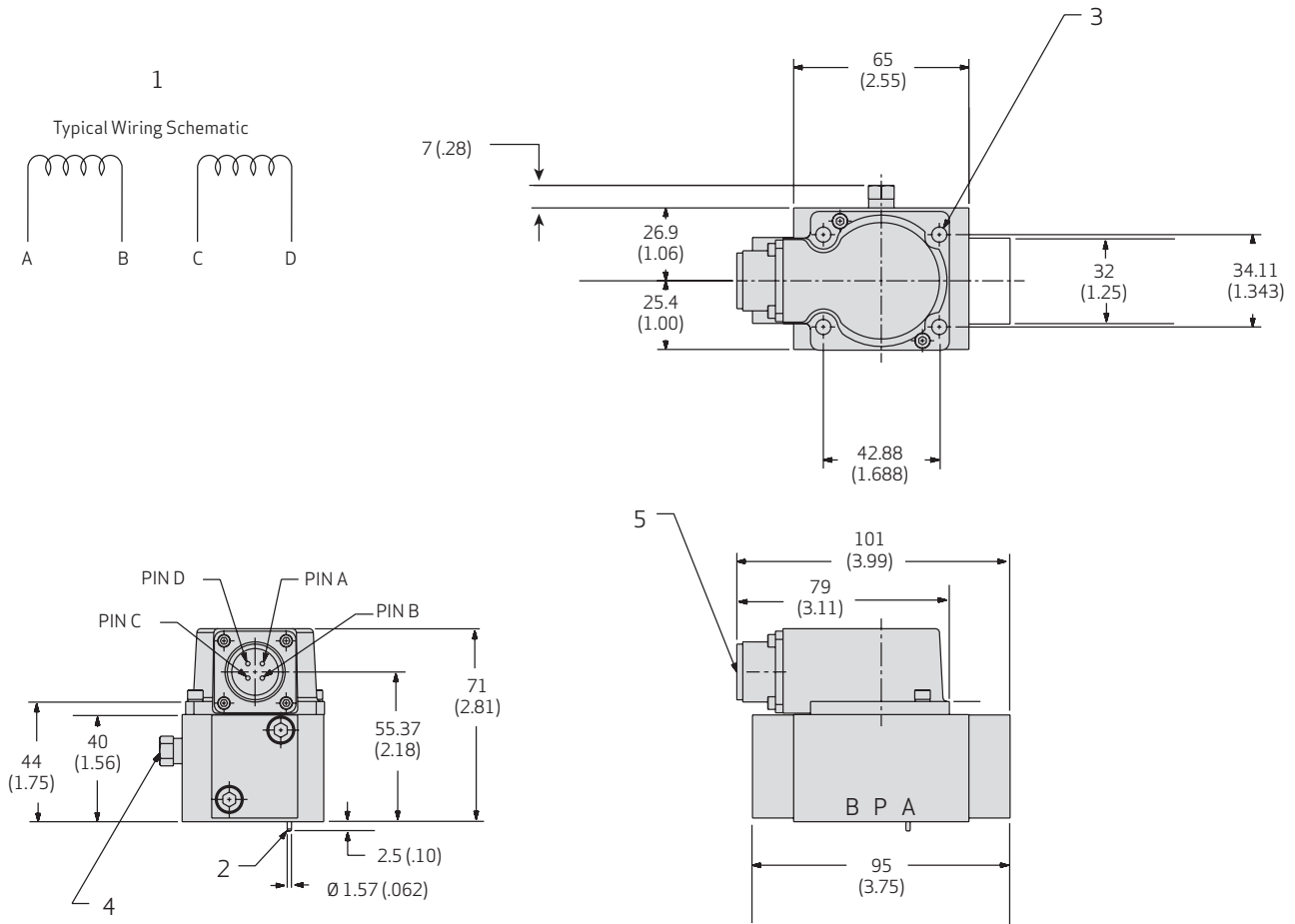

- 1 Typical wiring schematic
- 2 Location pin (refer to section Hole Pattern for position)
- 3 Valve mounting holes: 4X \varnothing 5.61 mm (0.221 in) or \varnothing 6.73 mm (0.265 in) thru
- 4 Null adjust screw (requires 3/8" wrench and 3/32" hex key)
- 5 Connector mates with MS3106F-14S-2S (Moog P/N: 49054F014S002S)

Notes:

Fluid:

Industrial hydraulic fluid per DIN 51524 parts 1 to 3 and ISO 11158, maintained to ISO 4406 Code 17/14/11 recommended
 Viscosity 10 to 97 mm²/s (cSt) at 38 °C
 (60 to 450 SUS at 100 °F)

Operating Temperature Range:

Fluid: -40 to +60 °C (-40 to +140 °F)
 Ambient: -40 to +135 °C (-40 to +275 °F)

Valve Phasing:

Flow out port B results when:
 Series coils: B & C connected, A+, D-
 Parallel coils: A & C connected, B & D connected,
 A and C+, B and D-
 Single coils: A+/B- or C+/D-

Surface:

Surface to which valve is mounted requires flatness of 0.05 mm (0.002 in) over 100 mm (3.94 in) and an average finish R_a better than 0.8 μm (0.000032 in)

Null Adjust:

Flow out port B results with the clockwise rotation of the null adjust screw

G77X/77X SERIES HOLE PATTERN FOR MOUNTING SURFACE

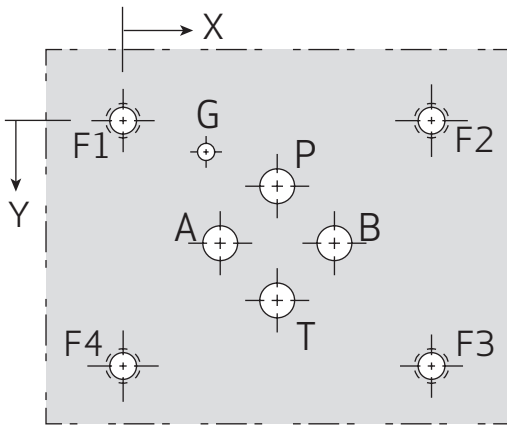

G771/771 Designation		P	A	B	T	G	F1	F2	F3	F4
Size Ø	mm	4.85	4.85	4.85	4.85	3.45	M5	M5	M5	M5
	in	0.191	0.191	0.191	0.191	0.136	.190-32	.190-32	.190-32	.190-32
Position X	mm	21.44	13.50	29.38	21.44	11.53	0	42.88	42.88	0
	in	0.844	0.532	1.157	0.844	0.454	0	1.688	1.688	0
Position Y	mm	9.13	17.07	17.07	25.01	4.37	0	0	34.14	34.14
	in	0.360	0.672	0.672	0.985	0.172	0	0	1.344	1.344

G772/772 Designation		P	A	B	T	G	F1	F2	F3	F4
Size Ø	mm	6.63	6.63	6.63	6.63	3.45	M5	M5	M5	M5
	in	0.261	0.261	0.261	0.261	0.136	.190-32	.190-32	.190-32	.190-32
Position X	mm	21.44	11.53	31.34	21.44	11.53	0	42.88	42.88	0
	in	0.844	0.454	1.234	0.844	0.454	0	1.688	1.688	0
Position Y	mm	7.16	17.07	17.07	26.97	4.37	0	0	34.14	34.14
	in	0.282	0.672	0.672	1.062	0.172	0	0	1.344	1.344

G773/773 Designation		P	A	B	T	G	F1	F2	F3	F4
Size Ø	mm	7.92	7.92	7.92	7.92	3.45	M6	M6	M6	M6
	in	0.312	0.312	0.312	0.312	0.136	.250-20	.250-20	.250-20	.250-20
Position X	mm	21.44	9.54	33.34	21.44	11.53	0	42.88	42.88	0
	in	0.844	0.376	1.313	0.844	0.454	0	1.688	1.688	0
Position Y	mm	5.17	17.07	17.07	28.97	4.37	0	0	34.14	34.14
	in	0.204	0.672	0.672	1.141	0.172	0	0	1.344	1.344

Ports

- G771/771 Port diameter: 4.85 mm (0.191 in)
O-ring outside diameter: 9.52 mm (0.375 in)
O-ring depth: 1.40 mm (0.055 in) deep
- G772/772 Port diameter: 6.60 mm (0.260 in) diameter
O-ring outside diameter: 12.65 mm (0.498 in)
O-ring depth: 1.40 mm (0.055 in) deep
- G773/773 Port diameter: 7.92 mm (0.312 in)
O-ring outside diameter: 14.27 mm (0.562 in)
O-ring depth: 1.40 mm (0.055 in) deep

Recommended Seals

- G771/771 Port O-rings 1.78 mm (0.070 in) cross section by 6.07 mm (0.239 in) inside diameter. Having compatible compound (universal size -010)
- G772/772 Port O-rings 1.78 mm (0.070 in) cross section by 9.24 mm (0.364 in) inside diameter. Having compatible compound (universal size -012)
- G773/773 Port O-rings 1.78 mm (0.070 in) cross section by 10.82 mm (0.426 in) inside diameter. Having compatible compound (universal size -013)

NULL FLOW ADJUSTMENT

It is often desirable to adjust the null flow of a servo valve independently of other system parameters. Valves with mechanical null adjustment allow for at least $\pm 10\%$ adjustment of null flow. The mechanical null adjustment is an eccentric bushing retainer pin, located above the tank port designation on the valve body, which if rotated provides control of the bushing location. Mechanical feedback elements position the spool relative to the valve body for a given input signal. Therefore, a movement of the bushing relative to the body changes the null flow.

Mechanical Adjustment Procedure

With zero current (electrical connector disconnected). Using a $3/8$ inch offset wrench, loosen the self-locking fitting until the null adjustor pin can be rotated. (This should usually be less than $1/2$ turn). DO NOT remove the self-locking fitting. Insert a $3/32$ inch Allen wrench in the null adjustor pin. Use the $3/32$ Allen wrench to rotate the mechanical adjustor pin to obtain the desired null flow. Re-torque the self-locking fitting to 57 in lbs.

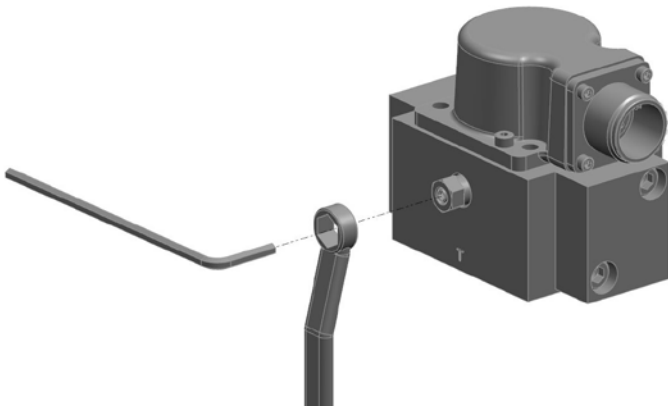

FLOW CALCULATION

The actual flow is dependent upon the electrical command signal and valve pressure drop. The flow for a given valve pressure drop can be calculated using the square root function for sharp edge orifices.

$$Q = Q_N \sqrt{\frac{\Delta p}{\Delta p_N}}$$

- Q actual flow
- Q_N rated flow
- Δ p actual pressure drop per spool land
- Δ p_N rated pressure drop per spool land

Flow Diagram

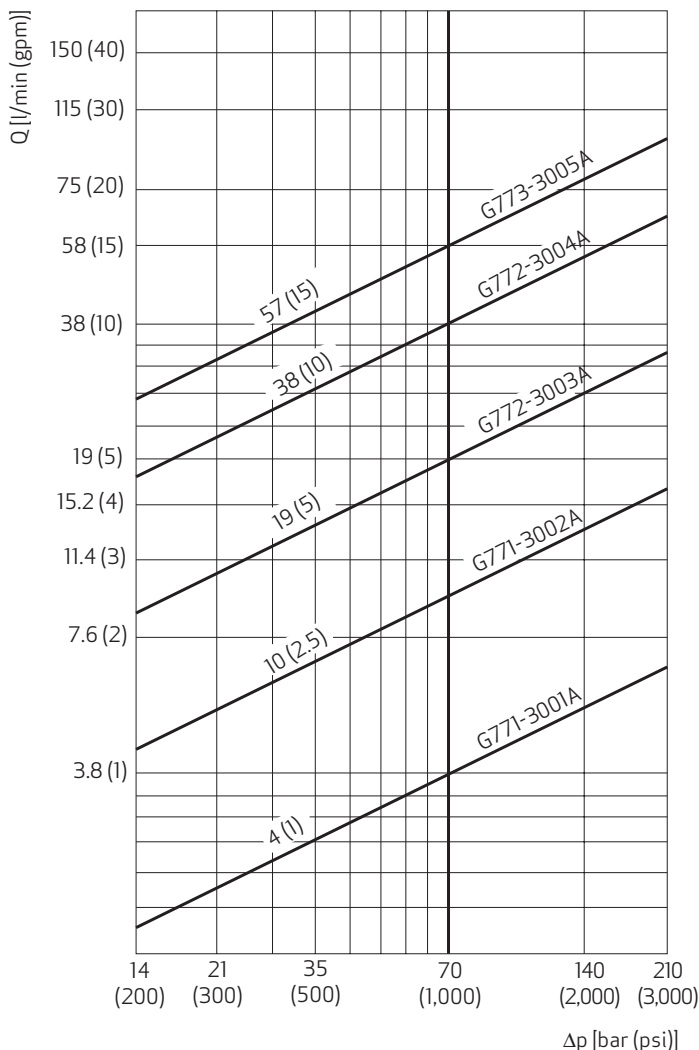

SPOOL NULL CUT OPTIONS

Standard Axis Cut

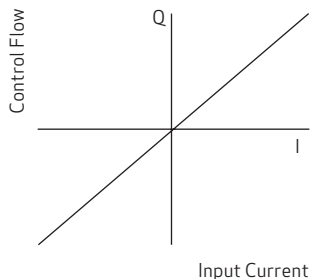

Default, without request for optional cuts

Open Center Spool Valves

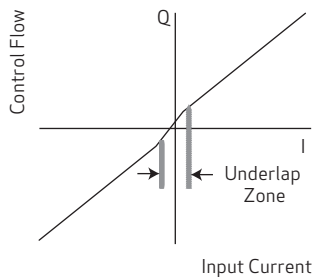

Normally used in hydraulic motor applications

Closed Center Spool Valves

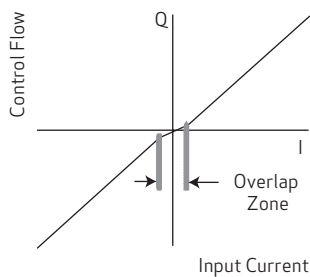

Normally used in failsafe applications

RELATED PRODUCTS

Din Rail Modules - Analog Control Cards

Moog's DIN rail mounted module analog control cards are ideal for use in enclosures where space is limited. Modules include servoamplifiers, transducer conditioning electronics, command and auxiliary function modules, valve drive amplifiers, and power supplies. All of these modules are CE marked and require a 24V DC supply. The modules mount to standard 35mm DIN rail mount for easy installation and removal.

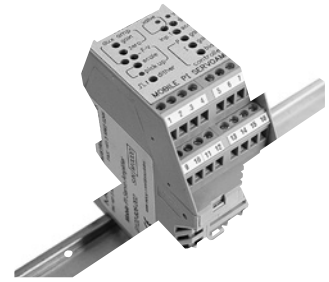

Din Rail Module

Portable Valve Testers - Evaluates Valves in the Field

Valve testers are a cost effective method for evaluating valves in the field. They provide a quick and easy means of differentiating between hydraulic and electronic problems. There are five models to choose from, each with different levels of capability and flexibility to meet your specific requirements. All valve testers have a compact, easily portable design.



Valve Tester

Mounting Manifolds - Easier Installation and Maintenance

Various mounting manifolds are available for standard industrial valves, including base and adapter types for mounting and flushing requirements. Other hardware such as bolts and connectors are also available.

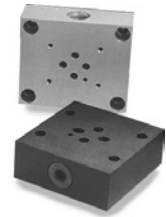

Mounting Manifolds

The specific accessories you may need for a particular model are listed in the relevant product catalogs and can be ordered through your local office.

Filtration - Oil Filtration Requirements for Industrial Servo Systems

The most effective way to reduce life cycle costs of an oil hydraulic system, regardless of the types of valve used, is through close attention to contamination control. For industrial servo systems the ideal system filter arrangement is summarized as follows:

- Use a 10 micron (Beta 10 \geq 75) high pressure filter without by-pass just before the valve or critical parts of the valve (e.g. pilot)
- Use a 3 micron (Beta 3 \geq 75) low pressure filter in the return or bypass line.
- Use a filter in the tank breather that is at least the same filtration level as the finest filter in the system.

This recommendation is based on the fact that most servo and proportional valves can accept the odd particle up to 25 microns so the pressure filter will protect the valve from catastrophic failure. The real work is done by the low pressure filter reducing the small particle contamination which is the prime contributor to component wear and silting.



Hydraulic Filters

Assuming that the filters are properly dimensioned and care is taken during initial installation and maintenance, the aim should be to limit oil contamination to 16/13 (under ISO 4406:1987) or 17/14/11 (under ISO 4406: 1999).

For long life, the maximum levels per ISO 4406: 1987 and 1999 are 13/10 and 16/13/10, respectively. It is important to note that these are maximum contamination levels and with proper care and regular filter change, significantly lower levels can and should be achieved. Attention must also be paid to a number of other factors that contribute to oil condition problems such as elevated temperatures, high tank humidity, "dirty" new oil, etc.

ROUTINE MAINTENANCE GUIDELINES

Every six months or 4,000 operating hours, check for proper operation of the control valve assembly by performing the preventative maintenance steps outlined below. These checks do not require removal of the valve from the process line. If a problem is suspected, repair the valve assembly prior to returning the unit to service.

- Replace the hydraulic filter element
- Stroke the valve and check for smooth, full-stroke operation; unsteady motion could indicate a servo valve, actuator or process valve problem

GENERAL INFORMATION

Effects when Storing Valves

The following effects may occur when storing valves for a long time:

- Sealing materials become brittle, possibly resulting in leaks
- Hydraulic fluid becomes gummy, possibly resulting in friction
- Electrolytic capacitors of the valve electronics may fatigue, possibly resulting in adverse effects on the valve electronics

Storage Time

The storage time starts at stock receipt and ends at mounting of the valve.

Preservatives

If conservation is carried out, use only conservatives which are compatible with the sealing materials and do not affect the valve, spare parts and accessories.

BEFORE STORAGE

Note: If the valves are exposed to aggressive environmental influences during storage, vacuum packaging may be necessary. We recommend the following preparatory measures for storage:

Mount the shipping plate on the valve.

This is the only way of adequately protecting the valves against the ingress of dirt and moisture and protecting the seals against the effects of ozone and UV.

Put the valve, spare parts and accessories into the original packaging.

Package each valve separately.

Enclose anti-tarnish paper or package the valve, spare parts and accessories with corrosion inhibiting film.
(Only for storage time > 1 year.)

Multipacks of single valves in their individual packages are allowed.

Seal the original packaging properly.

This is the only way of adequately protecting the valves, spare parts and accessories against damage.

STORAGE CONDITIONS

We recommend the following ambient conditions for storage:

- Dust-free, moderately ventilated
- As vibration-free and shock-free as possible

Shock resistance (as per EN 60068-2-27):
50 g, 6 directions, half-sine 3 ms

Vibration resistance (as per EN 60068-2-6):
30 g, 3 axes, frequency 10 to 2,000 Hz

Temperature

Recommended: +15 to +25 °C (+59 to +77 °F)

Permissible: -40 to +60 °C (-40 to +140 °F)

Temperature fluctuations >10 °C (50 °F) must be avoided.

Distance to shielded radiators: > 1 m (3 ft)

No direct exposure to sunlight

No sources of light with a high UV content

UV rays generate ozone, which damage sealing materials.

Relative air humidity: < 65 %, non condensing

AFTER STORAGE

We recommend to check the original packaging, valve, spare parts and accessories for possible damage or alterations due to storage, that is, before use.

Damaged or not functional valves, spare parts and accessories must not be started up.

Sealing materials with the following characteristics must not be used:

- Contamination
- Cracking
- Hardening/softening
- Stickiness
- Discoloration

Storage Time > 5 Years

We recommend that the valve be checked by us or one of our authorized service centers after a storage time of more than 5 years.

Storage Time > 10 Years

After a storage time of more than 10 years the valves have to be checked by us or one of our authorized service centers.

ABOUT MOOG

Moog Inc. is a worldwide designer, manufacturer and integrator of precision control components and systems. Moog's Industrial Group designs and manufactures high performance motion control solutions combining electric, hydraulic, and hybrid technologies with expert consultative support in a range of applications including energy production and generation machinery, industrial production machinery and simulation and test equipment. We help performance-driven companies design and develop their next-generation machines.

Moog maintains facilities in 26 countries around the globe. This vast scope ensures that our engineers remain close to the needs of machine builders and provide flexible design solutions and technical expertise tailored to our customers' toughest challenges.

Moog experts work in close collaboration with machine builders and application engineers to design motion control systems for greater productivity, higher reliability, superior connectivity, less costly maintenance and more effective operations. Our regional presence, industry knowledge and design flexibility ensures Moog motion control solutions are tailored to their environment—from meeting operating regulations and performance standards, to taking machine performance to a higher level.

Products

At the heart of every Moog solution is an array of products engineered for precision, high performance and reliability. For more than six decades, Moog products have been specified for critical machine applications.

Some are developed specifically for unique operating environments. Others are standard equipment on machines across many industries. All are continuously improved to take advantage of the latest technology breakthroughs and advancements.

Moog products include:

- Servo Valves and Proportional Valves
- Servo Motors and Servo Drives
- Servo Controllers and Software
- Radial Piston Pumps
- Actuators
- Integrated Hydraulic Manifold Systems and Cartridge Valves
- Slip Rings
- Motion Bases

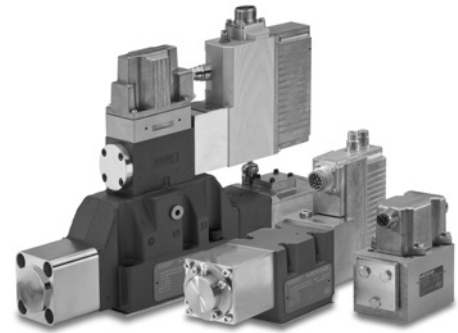

Servo Valves

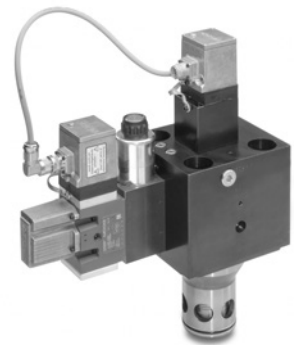

Active Cartridge Valves

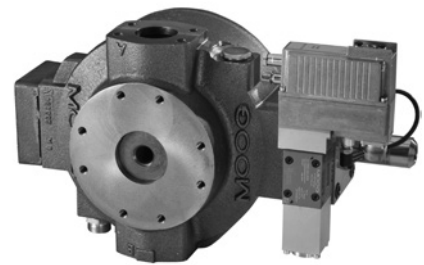

Radial Piston Pumps



Servo Drives

ABOUT MOOG

Hydraulic solutions

Since Bill Moog invented the first commercially viable servo valve in 1951, Moog has set the standard for world-class hydraulic technology. Today, Moog products are used in a variety of applications - providing high power, enhanced productivity and ever better performance for some of the world's most demanding applications.

Electric solutions

Clean operation, low noise generation, less maintenance and reduced power consumption make Moog electric solutions ideal for applications worldwide. Moog is the ideal partner for applications where transitioning technologies requires special expertise.

Hybrid solutions

By incorporating the advantages of existing hydraulic and electric technologies - including modular flexibility, increased efficiency and cleanliness - into innovative hybrid solutions, Moog offers new performance potential in specialized applications.



Flight Simulation



Formula One Simulation Table

Moog Global Support

Moog Global Support is our promise to offer world-class Repair and Maintenance Services delivered expertly by our trained technicians. With the reliability only available from a leading manufacturer with facilities around the world, Moog offers you service and expertise you can count on to keep your equipment operating as it should.

This promise offers many benefits to our customers including:

- Reduce your downtime by keeping critical machines running in peak performance
- Protect your investment by ensuring reliability, versatility and long-life of products
- Better plan your maintenance activities and make systematic upgrades
- Leverage our flexible programs to meet the unique service requirements of your facility

Look to Moog for global support including:

- Repair services using OEM parts are performed by trained technicians to the latest specifications
- Stock management of spare parts and products to prevent unplanned downtime

- Flexible programs, tailored to your needs such as upgrades, preventative maintenance and annual/multi-year contracts
 - On-site services bring the expertise to you, providing quicker commissioning, set-up and diagnostics
 - Access to reliable services that are guaranteed to offer consistent quality anywhere in the world
- For more information on Moog Global Support visit www.moog.com/industrial/service.



ACCESSORIES AND SPARE PARTS

Series Dependent Accessories and Spare Parts

Accessories G77X/77X Series

Part designation	Description	Part number
Attachment screws G771/771 and G772/772 Series	4 required M5 x 50 ISO 4762-10.9 (0.190-32 by 2.0 long) tightening torque to 5 Nm (44 lbf-in)	B64929-006B050 (C39674-532)
G773/773 Series	4 required M6x60 ISO 4762-10.9 (0.250-20 by 2.25 long) tightening torque to 7.5 Nm (66 lbf-in)	B64929-007B060 (C66391-136B)
Mating connector	4 pin electrical connector	-49054F0145002S (MS3106F145-2S)
Servo amplifier	P - I servo amplifier - compact DIN rail housing	G122-829-001
Mounting Manifold G771/771 Series G772/772 Series G773/773 Series	Base mounting manifold	B64389AM005 B64389AM003 B64389AM001
Flushing plate G771/771 and G772/772 Series G773/773 Series	Manifold employed in place of valve when initially cleaning hydraulic fluids	A01704AM001 A01704AM002
AMO manifold G773/773 Series	Adjustable metering orifice manifold used to bleed fluid between A and B ports for better pressure control	A72684AM006
CRV manifold G773/773 Series	Cross port relief manifold used to limit pressure levels in ports A and B	A72682AM001-XXXX

Spare Parts G77X/77X Series

Part designation	Description	Material	Part number
Base O-ring G771/771 Series	4 required for P, T, A, and B ports 6.0 mm (0.239 in) inside diameter x 1.8 mm (0.070 in) cross section. Equivalent MIL-R-83248 size -010	Fluorocarbon FKM 85 shore	-42082-007
G772/772 Series	4 required for P, T, A, and B ports 9.24 mm (0.426 in) inside diameter x 1.8 mm (0.070 in) cross section. Equivalent MIL-R-83248 size -012		-42082-013
G773/773 Series	4 required for P, T, A, and B ports 10.8 mm (0.364 in) inside diameter x 1.8 mm (0.070 in) cross section. Equivalent MIL-R-83248 size -013		-42082-022
Replaceable filter	60 mu nominal		C39486-005-060
Filter replacement kit	Contains the following: 4 pieces O-ring 1.8 mm (0.070) inside diameter x 1.0 mm (0.040 in) cross section 2 pieces O-ring 6.9 mm (0.270) inside diameter x 1.8 mm (0.070 in) cross section. Equivalent MIL-R-83248 size -5052 2 pieces O-ring 5.3 mm (0.208) inside diameter x 1.8 mm (0.070 in) cross section. Equivalent MIL-R-83248 size -009 1 piece filter tube 60 mu	Fluorocarbon FKM 85 shore	B52555RK054K001

Documents (not included in scope of delivery)

Part designation	Description	Remark	Part number
Catalog	G77X/77X series general information	Note: Visit www.moog.com/industrial/literature to download document	CDL 6651
Service manual	G77X/77X standard series	Note: Visit www.moog.com/industrial/literature to download document	CDS 6674
Service manual	G77X/77X intrinsically safe (K) series	Note: Visit www.moog.com/industrial/literature to download document	CDS 6768

ORDERING CODE

Model number (assigned at the factory)

Type designation

G77/77

1 2 3 4 5 6 7 8 9 10

Base Number	
1	.625 Port circle
2	.780 Port circle
3	.937 Port circle

Optional feature	
-	Series specification

Model designation (assigned at factory)

Factory identification (revised level)

1 Valve version	
H	High response .260 spool 04, 10, 19 lpm (1, 2.5, 5 gpm)
S	Standard response .312 spool 38, 57 lpm (10, 15 gpm)

2 Rated flow in l/min (gpm)			
For $\Delta p_N = 35$ bar (500 psi) per spool land			
04	4	(1)	G771 series only
10	10	(2.5)	G771 series only
19	19	(5.0)	G772 series only
38	38	(10.0)	G772 series only
57	57	(15.0)	G773 series only

3 Maximum operating pressure in psi (bar) and body material		
F	3,000	(210) aluminum

10 Signals for 100 % spool stroke	
H	± 7.5 mA series (± 15 mA parallel)
L	± 20 mA series (± 40 mA parallel)

9 Valve connector	
A	Connector over A side (RH)
B	Connector over B side (LH)

8 Seal material	
V	Fluorocarbon (FKM) 85 Shore D

7 Pilot connections	
4	Internal only

6 Spool position without electrical signal	
M	Mid position

5 Pilot stage design	
F	Standard dynamics

4 Main spool type	
O	4-way / axis cut / linear
D	4-way / $\pm 10\%$ / linear

Preferred Models

Model Number	Type Designation lpm	Rated Flow ($\Delta 1,000$ psi) gpm	Rated Current (single coil) mA	Rated Current (single coil)
G771/771-3001A	H04FOFM4VBL	4	1.0	40
G771/771-3002A	H10FOFM4VBL	10	2.5	40
G772/772-3003A	H19FOFM4VBL	19	5.0	40
G772/772-3004A	S38FOFM4VBL	38	10.0	40
G773/773-3005A	S57FOFM4VBL	57	15.0	40

TAKE A CLOSER LOOK

Moog designs a range of motion control products that complement the performance of those featured in this catalog. Visit our website for more information and contact the moog facility nearest you.

Argentina
+54 11 4326 5916
info.argentina@moog.com

India
+91 80 4057 6666
info.india@moog.com

Singapore
+65 677 36238
info.singapore@moog.com

Australia
+61 3 9561 6044
info.australia@moog.com

Ireland
+353 21 451 9000
info.ireland@moog.com

South Africa
+27 12 653 6768
info.southafrica@moog.com

Brazil
+55 11 3572 0400
info.brazil@moog.com

Italy
+39 0332 421 111
info.italy@moog.com

Spain
+34 902 133 240
info.spain@moog.com

Canada
+1 716 652 2000
info.canada@moog.com

Japan
+81 46 355 3767
info.japan@moog.com

Sweden
+46 31 680 060
info.sweden@moog.com

China
+86 21 2893 1600
info.china@moog.com

Korea
+82 31 764 6711
info.korea@moog.com

Switzerland
+41 71 394 5010
info.switzerland@moog.com

Finland
+358 9 2517 2730
info.finland@moog.com

Luxembourg
+352 40 46 401
info.luxembourg@moog.com

Turkey
+90 216 663 6020
info.turkey@moog.com

France
+33 1 4560 7000
info.france@moog.com

The Netherlands
+31 252 462 000
test@moog.com

United Kingdom
+44 168 429 6600
info.uk@moog.com

Germany
+49 7031 622 0
info.germany@moog.com

Norway
+47 6494 1948
info.norway@moog.com

USA
+1 716 652 2000
info.usa@moog.com

Hong Kong
+852 2 635 3200
info.hongkong@moog.com

Russia
+7 8 31 713 1811
info.russia@moog.com

www.moog.com/industrial

Moog is a registered trademark of Moog Inc. and its subsidiaries. All trademarks as indicated herein are the property of Moog Inc. and its subsidiaries.

©2013 Moog Inc. All rights reserved.

G77X/77X Series Flow Control Servo Valves
TJW/PDF, Rev. J, September 2013, Id. CDL6651-en