

HONOR

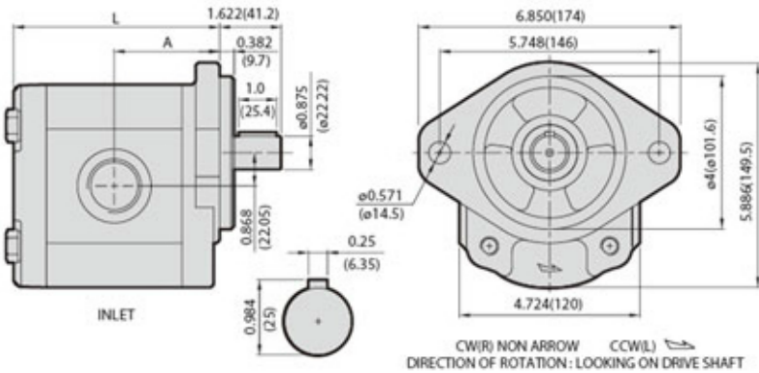

***High Pressure
Gear Pumps & Motors***

OVERALL DIMENSIONS



ORDERING EXAMPLE

For Example **3** **G** **B** **6** **U1** **□□** **□**
 SERIES TYPE FLANGE SHAFT PORT DISPL. ROTATION
 If you need pump with displ.2.01 c.i.r and rotation is cw, the model number is : **3GB6U133R**

PERFORMANCE DATA

MODEL	DISPLACEMENT		PRESSURE psi(MPa)		RPM RANGE	DIMENSIONS Inch(mm) SUITABLE 'B', 'C', 'E' MOUNTING FLANGES		WEIGHT	
	c.i.r	cm ³ /r	CONTINUOUS	MAX.		A	L	Kg	LBS
18	1.10	18.0	3500(25)	3800(27)	3000	2.539(64.5)	4.961(126)	8.4	18.5
20	1.22	20.0	3500(25)	3800(27)	3000	2.559(65.0)	5.000(127)	8.5	18.7
23	1.40	23.0	3500(25)	3800(27)	3000	2.579(65.5)	5.039(128)	8.6	18.9
25	1.52	25.0	3500(25)	3800(27)	3000	2.618(66.5)	5.118(130)	8.7	19.1
28	1.70	28.0	3500(25)	3800(27)	3000	2.657(67.5)	5.197(132)	8.9	19.6
33	2.01	33.0	3500(25)	3800(27)	3000	2.736(69.5)	5.354(136)	9.1	20.0
38	2.31	38.0	3500(25)	3800(27)	3000	2.815(71.5)	5.512(140)	9.3	20.5
44	2.68	44.0	3100(22)	3400(24)	2500	2.894(73.5)	5.669(144)	9.5	20.9
52	3.17	52.0	2800(20)	3100(22)	2500	2.992(76.0)	5.866(149)	9.8	21.6
60	3.66	60.0	2600(18)	2800(20)	2500	3.110(79.0)	6.102(155)	10.0	22.0
70	4.27	70.0	2300(16)	2600(18)	2500	3.248(82.5)	6.378(162)	10.4	22.9
80	4.88	80.0	2100(15)	2400(17)	2300	3.346(85.0)	6.575(167)	10.7	23.5
90	5.49	90.0	2000(14)	2300(16)	2000	3.465(88.0)	6.811(173)	11.1	24.4

DRIVE SHAFTS

SUITABLE FOR C FLANGE

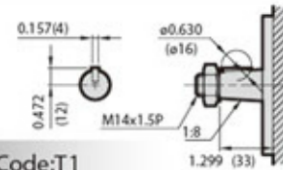

Code:T1

SUITABLE FOR E FLANGE

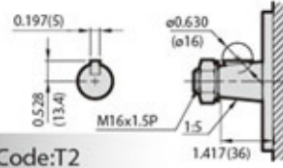

Code:T2

DRIVE SHAFTS

SUITABLE FOR A FLANGE

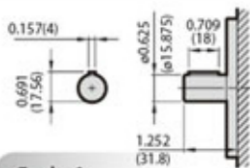

Code:1

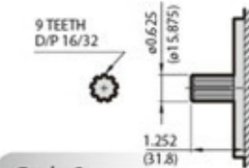

Code:2

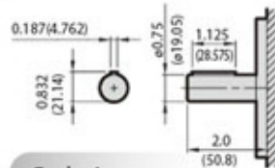

Code:4

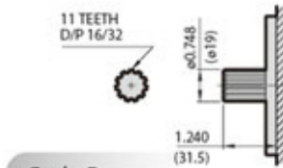

Code:5

SUITABLE FOR B FLANGE

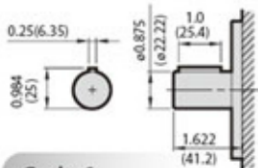

Code:6

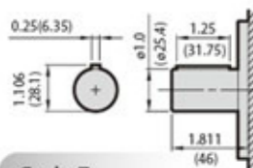

Code:7

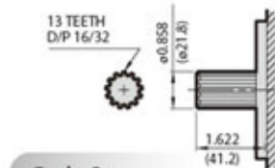

Code:8

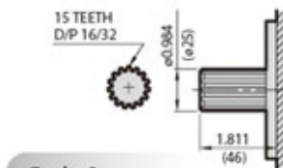

Code:9

■ MOUNTING FLANGES

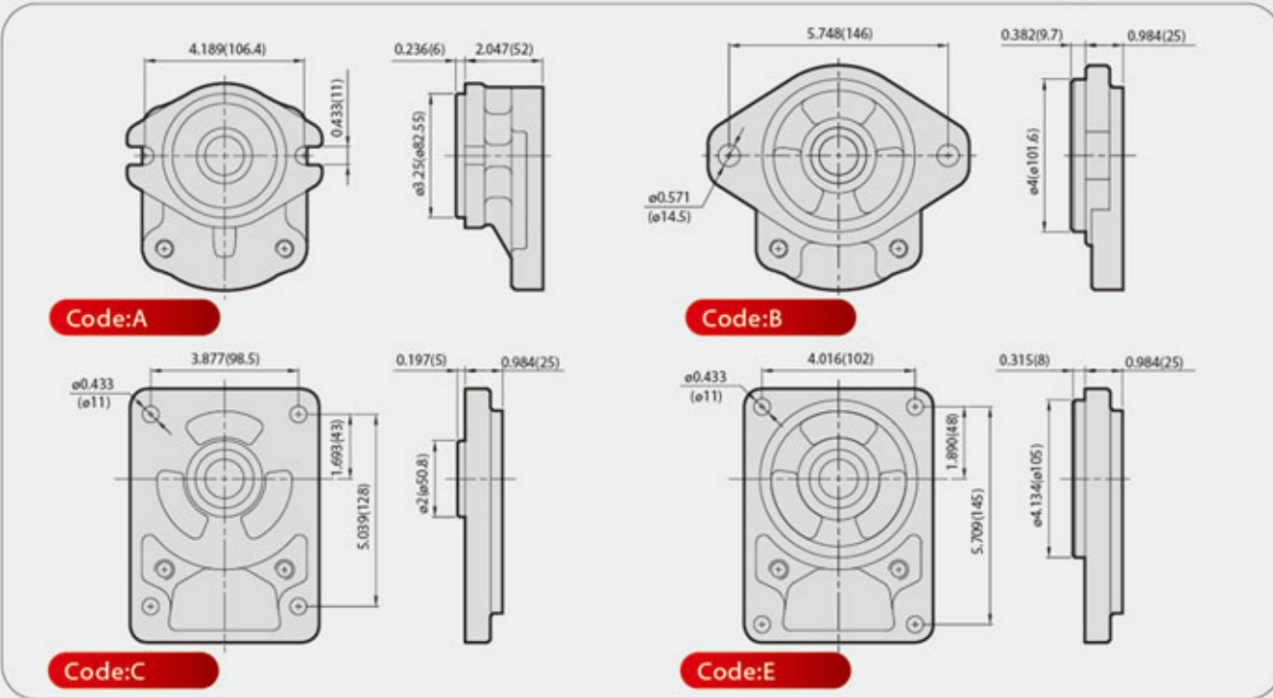

■ PORTS

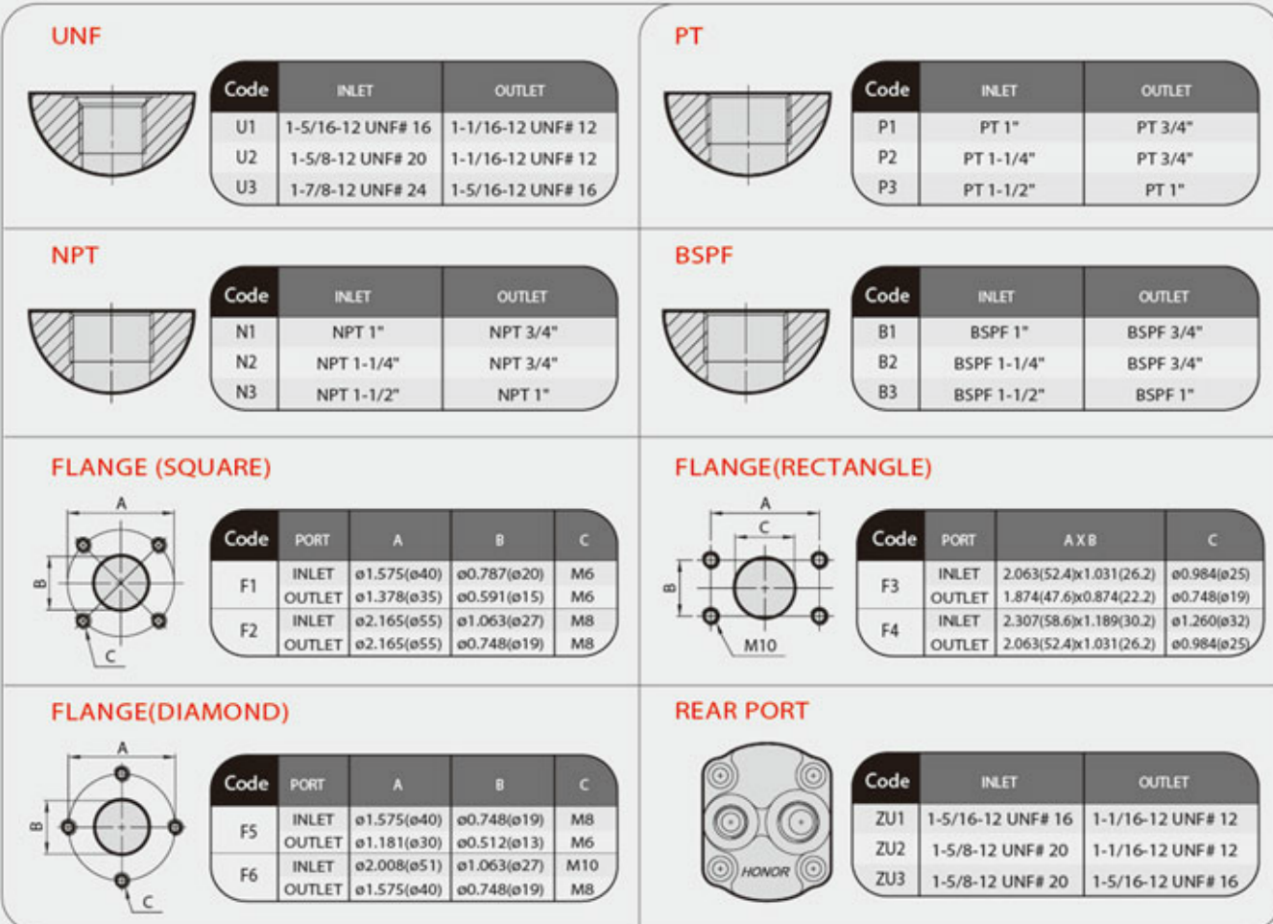

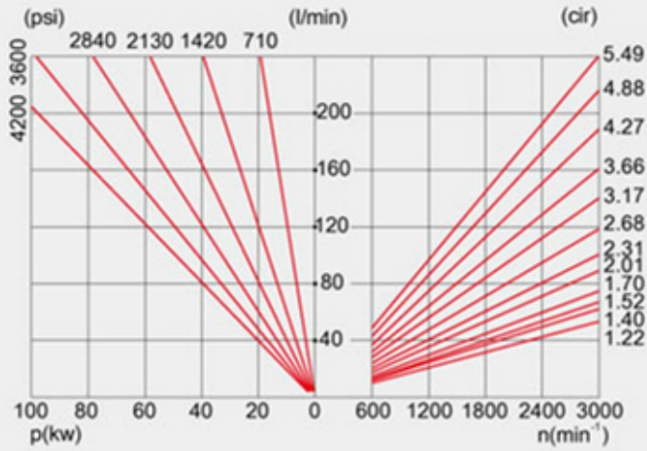

GROUP 3

3G/3D/3T SERIES PERFORMANCE CURVE

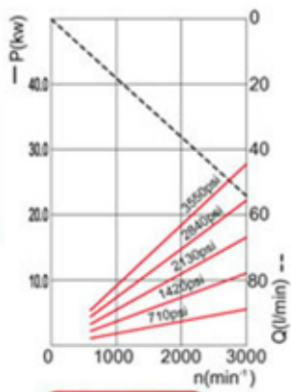

MODEL:20

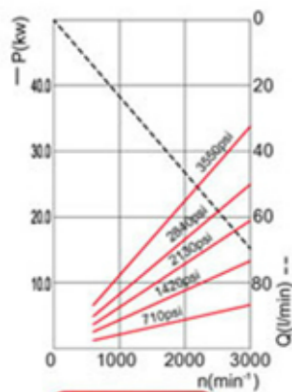

MODEL:23

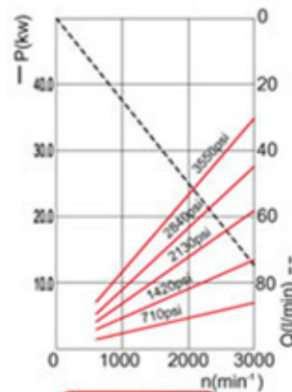

MODEL:25

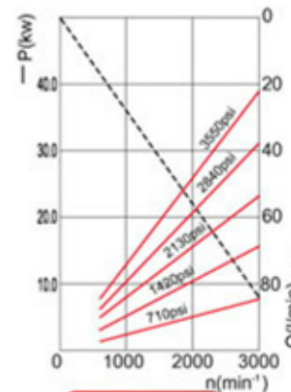

MODEL:28

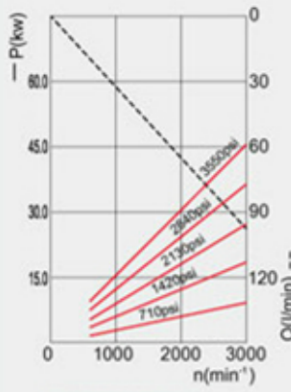

MODEL:33

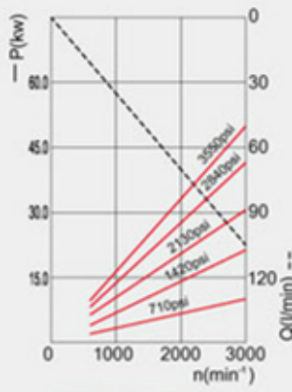

MODEL:38

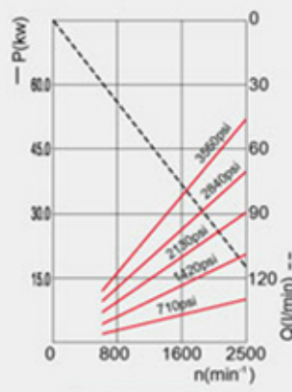

MODEL:44

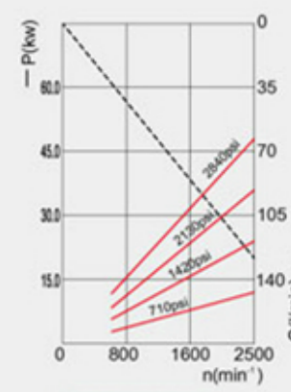

MODEL:52

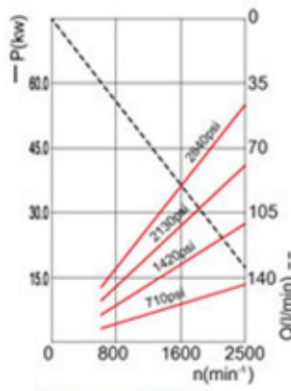

MODEL:60

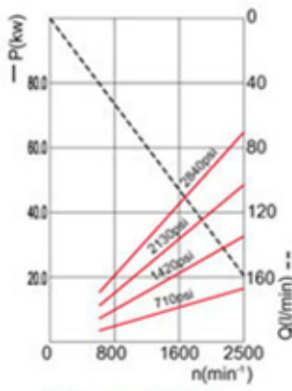

MODEL:70

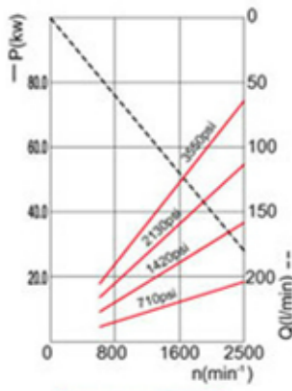

MODEL:80



MODEL:90

HONOR

Sole Agent / Authorized Distributor

• HONOR PUMPS U.S.A.

222 S. NAVIGATION BLVD., CORPUS CHRISTI, TEXAS, 78405, USA
TEL: +1-800-984 9727 | FAX: +1-713-461 9631 | E-mail: service@honorpumps.com
<http://www.honorpumps.com>

• SOUTHERN FLUID POWER CANADA

100 FERNSTAFF COURT, UNIT 1, VAUGHAN, ONTARIO, L4K 3L9
TEL: +1-905-760-5546 | FAX: +1-905-760-0685 | E-mail: larry@southernfluidpower.net
<http://www.southernfluidpower.ca>

• PT. TIARA ABADI NUSANTARA JAYA INDONESIA

JL. RAYA DUPAK 63 KAV. E10, SURABAYA, 60172 (KOMPLEK PERTOKOAN MUTIARA DUPAK)
TEL: +62-3153 52104 | FAX: +62-3153 52094 | E-mail: pt.tanj@gmail.com

• NINGBO HONOR INTERNATIONAL TRADING CO., LTD. CHINA

BLDG.4, NO.8 CHUANGYE 3 ROAD, FREE TRADE WEST ZONE, NINGBO.
TEL: +86-574-8689 5161 | FAX: +86-574-8689 5163 | E-mail: honor2@jm-best.com

• JMEC HONOR VIETNAM COMPANY LIMITED

Số nhà 6, Ngách 91/16, Ngõ 91 đường Trần Duy Hưng, phường Trung Hòa, quận Cầu Giấy, TP. Hà Nội, Việt Nam.
TEL: +84-432-000-216 | FAX: +84-432-000-225 | E-mail: honor_hanoi@honorpump.com.tw

• FUTECH ENGINEERING TRADING COMPANY LIMITED

G/F., 123C TIN HA ROAD, HUNG SHUI KIU, YUEN LONG, NEW TERRITORIES, HONG KONG
TEL: +852-3118 1665 | FAX: +852-3118 6557 | E-mail: sales@chinahydraulic.com
<http://futechengineering.com>

Headquarters / Factory

• HONOR GEAR PUMPS CORP. TAIWAN

NO.190, CHENG KUNG 3 ROAD, NAN KANG INDUSTRY PARK, NAN TOU CITY, 54066, TAIWAN.
TEL: +886-49-225 0421 | FAX: +886-49-225 7894 | E-mail: service@honorpump.com.tw
<http://www.honorpump.com.tw>

Warranty Statement

HONOR Gear Pumps Corp. products are warranted for 12 months from date of shipment from HONOR Taiwan or our authorized sales agents worldwide, to be free from defects in material and workmanship under correct use, normal operating conditions, and proper application.

HONOR's obligation under this warranty is limited to repair or exchange, at Honor's option, of any HONOR product or part which proves to be defective as provided herein.

Warranty consideration will only be extended upon return of the product to HONOR or Honor's authorized sales agents, for inspection, and then only if authorization to return has been given prior to the return.

Warranty will not extend to product damaged by accident, abuse, misuse, or misapplication, nor to goods altered or repaired by other than HONOR.



HR1606