

Application:

Subplate used for mounting directional valve with NFPA D05 Interface.

A, B, PR & TK ports on bottom surface.

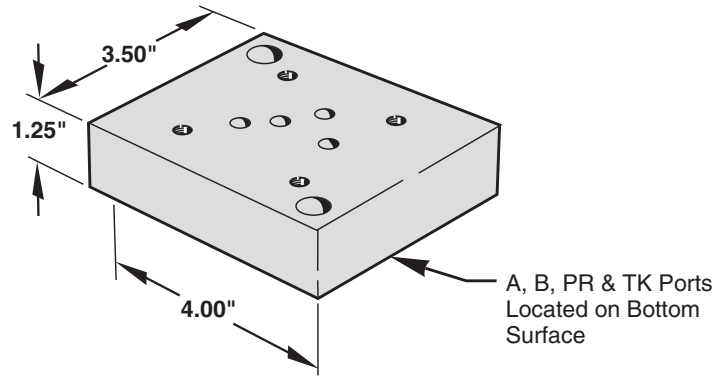

3

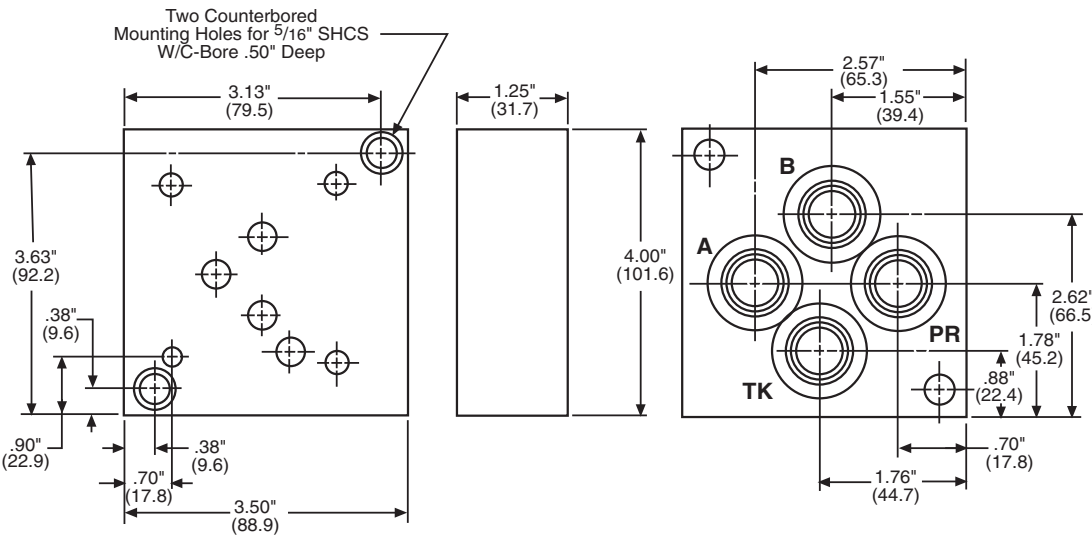

Thread Code	PR, TK, A & B
P6	3/8" NPT
S6	#6 SAE
B6	3/8" BSPP
T6	3/8" BSPT
M6	M14 x 1.5
P8	1/2" NPT
S8	#8 SAE
B8	1/2" BSPP
T8	1/2" BSPT
M8	M18 x 1.5

MAGNALOY D05 SUPER SAVER SUBPLATE PART NUMBER BREAKDOWN

