

Temposonics®

Magnetostrictive Linear Position Sensors

DATA SHEET

R-Series POWERLINK

- Suitable for hard real-time requirements
- Multi-position measurement
- LEDs for sensor diagnostics

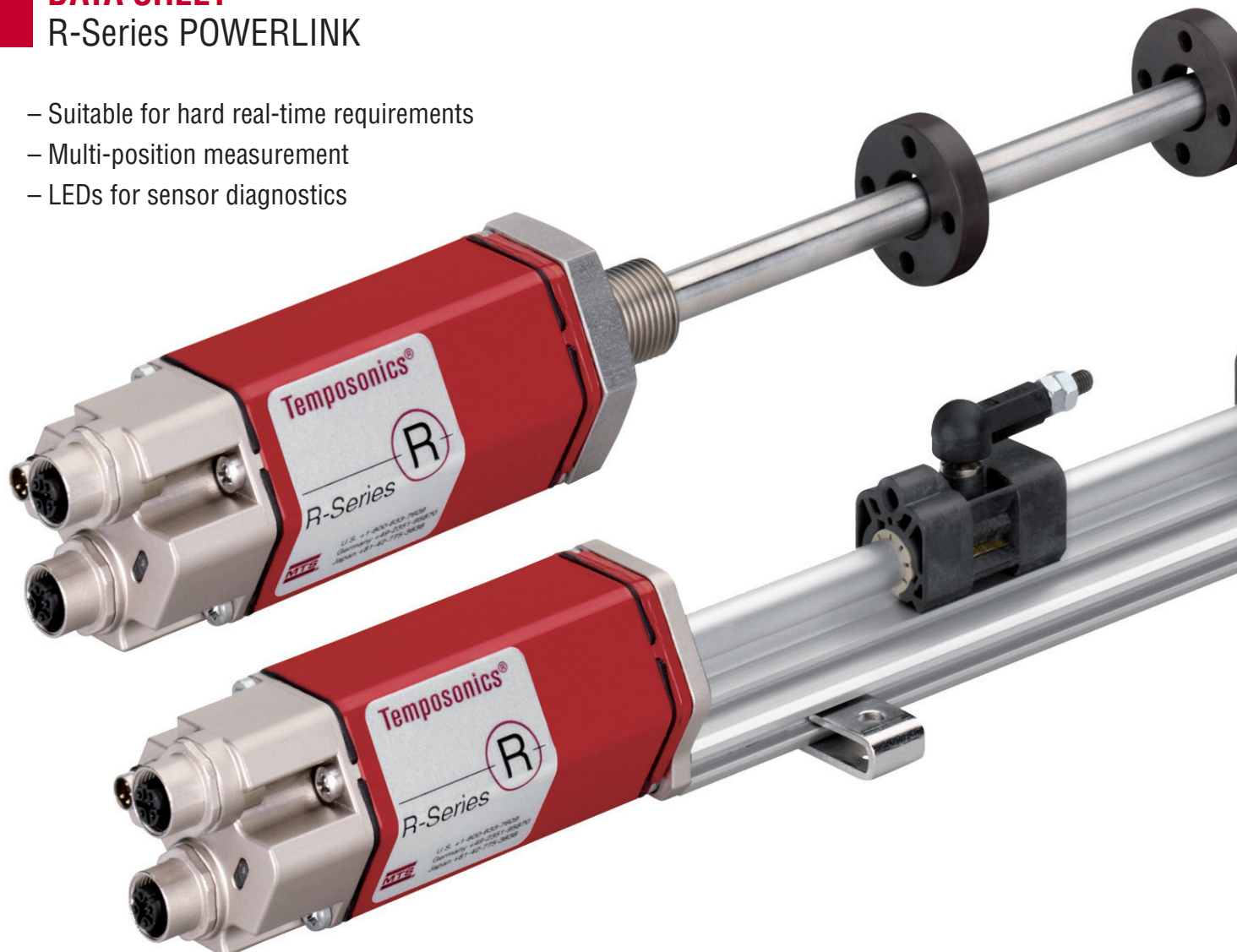

MEASURING TECHNOLOGY

For position measurement, the absolute, linear Temposonics® position sensors make use of the properties offered by the specially designed magnetostrictive waveguide. Inside the sensor a torsional strain pulse is induced in the waveguide by momentary interaction of two magnetic fields. The interaction between these two magnetic fields produces a strain pulse, which is detected by the electronics at the head of the sensor. One field is produced by a moving position magnet, which travels along the sensor rod with the waveguide inside. The other field is generated by a current pulse applied to the waveguide. The position of the moving magnet is determined precisely by measuring the time elapsed between the application of the current pulse and the arrival of the strain pulse at the sensor head. The result is a reliable position measurement with high accuracy and repeatability.

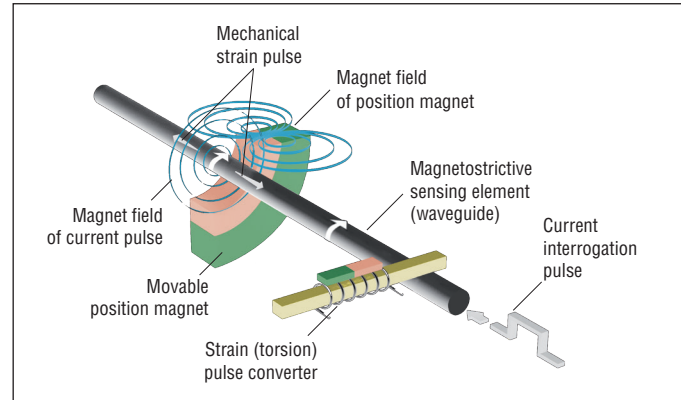

Ethernet POWERLINK V2 Interface

Temposonics® position sensors fulfil the requirements of the Ethernet POWERLINK Standardization Group (ESPG). Ethernet POWERLINK V2 is an open protocol based on the Ethernet-standard according to IEEE 802.3. It is an extension to the Ethernet protocol which allows real-time data communication. Within the Ethernet POWERLINK protocol a CANopen based communication protocol for user data is specified. POWERLINK is the only Ethernet protocol that meets hard real-time requirements with a software-only concept. No special POWERLINK hardware is needed.

Sensor interface :

- Absolute position information
- Velocity

TECHNICAL DATA

Input	
Measured value	Position, velocity / Option: Multi-magnet measurement (max. 4 positions simultaneous)
Stroke length	Profile: 25...5000 mm / Rod: 25...7600 mm
Output	
Interface	Ethernet POWERLINK Standardization Group (ESPG)
Data protocol	POWERLINK V2 according to IEEE 802.3
Accuracy	
Resolution - Displacement	up to 1 µm
Update time	1.0 ms up 2400 mm / 2.0 ms up 4800 mm / 4.0 ms up 7600 mm stroke length
Linearity ¹	< ± 0.01 % F.S. (Minimum ± 40 µm)
Repeatability	< ± 0.001 % F.S. (Minimum ± 2.5 µm)
Temperature coefficient	< 15 ppm/°C
Hysteresis	< 4 µm
Operating conditions	
Magnet movement velocity	any
Operating temperature	0...+70 °C
Dew point, humidity	90 % rel. humidity, no condensation
Ingress protection ²	Profile: IP65 / Rod: IP67
Shock test	100 g (single shock), IEC-Standard 6008-2-27
Vibration test	15 g / 10...2000 Hz, IEC-Standard 6008-2-6 (resonance frequencies excluded)
EMC test	Electromagnetic emission EN 61000-6-4 (for use in industrial environment) Electromagnetic susceptibility EN 61000-6-2 The sensor meets the requirements of the EC directives and is marked with CE
Design/Material	
Diagnostic display	LEDs beside connector
Profile model:	
Sensor electronics housing	aluminum
Sensor profile	aluminum
Rod model:	
Sensor electronics housing	aluminum
Rod with flange	stainless steel 1.4301 / AISI 304
Installation	
Mounting position	any
Profile	moveable mounting clamps or T-slot nuts M5 in base channel
Rod	threaded flange M18×1.5 or ¾"-16 UNF-3A, Hex nut M18
Electrical connection	
Connection type	4 pin connector M12-DF, 4 pin connector M8
Operating voltage ³	24 VDC (-15 / +20 %)
Polarity protection	up to -30 VDC
Overvoltage protection	up to 36 VDC
Current drain	110 mA typical
Ripple (power supply)	< 0.28 Vpp
Dielectric strength	500 VDC (DC ground to machine ground)

1/with magnet # 252 182.

2/The IP rating is not part of the UL approval

3/UL Recognition requires an approved power supply with energy limitation UL 61010-1), or Class 2 rating according to the National Electrical Code (USA) / Canadian Electrical Code.

PROFILE DESIGN

Temposonics® RP offers modular construction, flexible mounting configurations and easy installation. Position measurement is non-contact via two versions of permanent magnets.

- A sliding magnet running in profile housing rails. Connection with the moving machine part is via a ball jointed arm to taking up axial forces.
- A floating magnet, mounted directly on the moving machine part, travels over the profile at a low distance. Its air-gap allows the correction of small misalignments at installation.

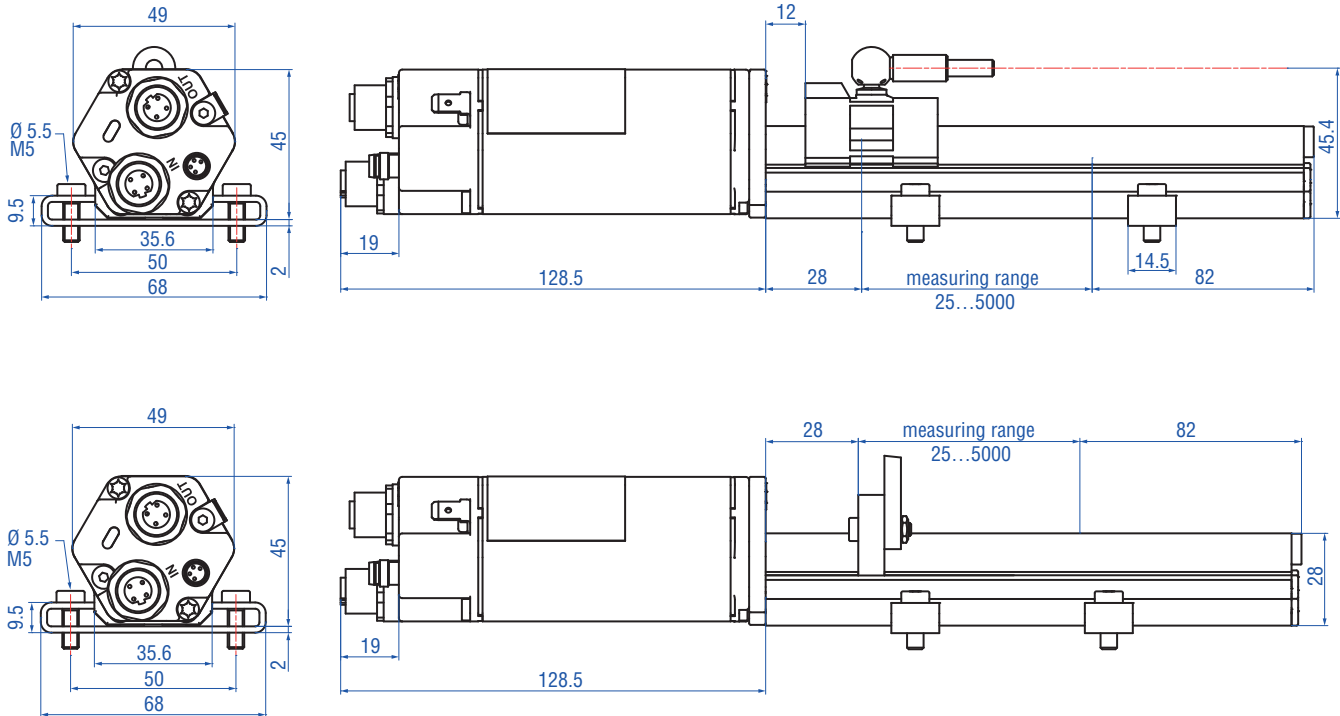

HIGH PRESSURE ROD DESIGN

Temposonics® RH with a pressure resistant stainless steel flange and sensing rod. They are suitable in all hydraulic cylinders suitable for use in hydraulic cylinders and externally in all applications where space is a problem. Position measurement is via ring or U-magnets travelling along the sensing rod without any mechanical contact.

Advantage...

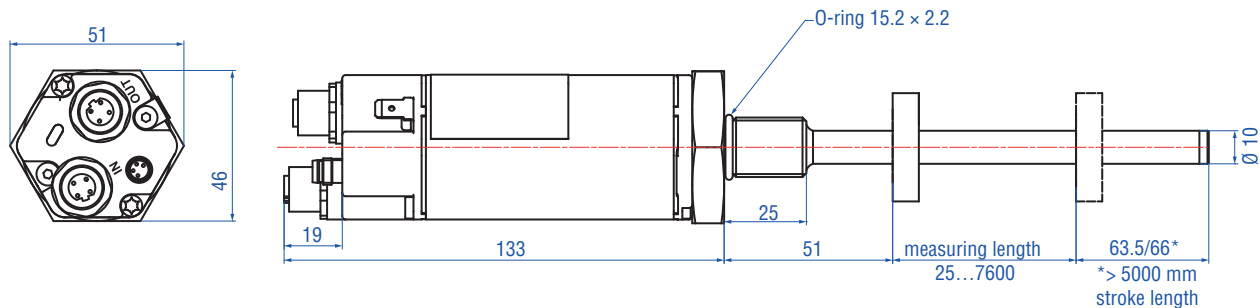

CONNECTOR WIRING (Connector view sensor)

BUS Out

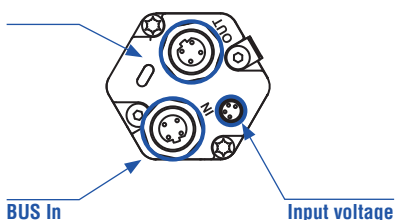

BUS In/Out	Pin	Cable	Function
 female	1	YE	Tx+
	2	WH	Rx+
	3	OG	Tx-
	4	BU	Rx-

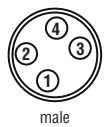
Input voltage	Pin	Cable	Function
 male	1	BN	+24 VDC (-15/+20 %)
	2	WH	n.c.
	3	BU	DC Ground (0 V)
	4	BK	n.c.

ACCESSORIES

Position magnets for profile model (please order separately)

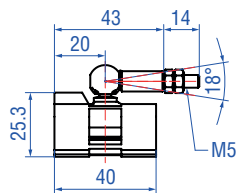

Magnet slider S
Part no. 252 182

Material: GFK, magnet hard ferrite
Weight: ca. 35 g
Operating temperature: -40...+75 °C

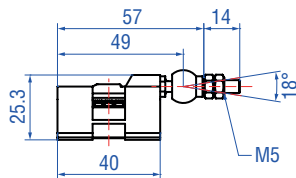

Magnet slider V
Part no. 252 184

Material: GFK, magnet hard ferrite
Weight: ca. 35 g
Operating temperature: -40...+75 °C

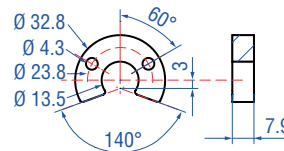

U-magnet OD33
Part no. 251 416-2

Material: PA ferrite
Weight: ca. 10 g
Operating temperature: -40...+100 °C
Surface pressure: max. 40 N/mm²
Fastening torque for M4 screws: max. 1 Nm

Position magnets for rod model (please order separately)

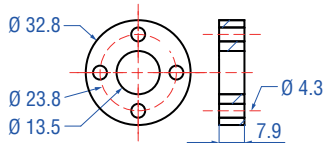

Ring magnet OD33
Part no. 201 542-2

Material: PA ferrite GF20
Weight: ca. 14 g
Operating temperature: -40...+100 °C
Surface pressure: max. 40 N/mm²
Fastening torque for M4 screws: max. 1 Nm

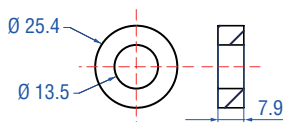

Ring magnet OD25,4
Part no. 400 533

Material: PA ferrite
Weight: ca. 10 g
Operating temperature: -40...+100 °C
Surface pressure: max. 40 N/mm²

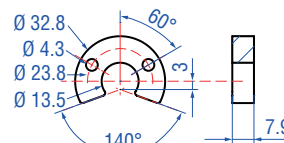

U-magnet OD33
Part no. 251 416-2

Material: PA ferrite
Weight: ca. 10 g
Operating temperature: -40...+100 °C
Surface pressure: max. 40 N/mm²
Fastening torque for M4 screws: max. 1 Nm

Connection types



Power cable, female 4 pin (M8) and cable with pigtail termination
Part no.: 5 m: 530 066
10 m: 530 096
15 m: 530 093

Wire gage: 4 × 0.25 mm² shielded
Cable jacket: PUR; gray
Max. cable Ø: 8 mm



Industrial Ethernet cable (Cat 5e Es) d-coded
Part no.: 530 064

Connector type: two male, 4 pin (M12)
Cable jacket: PUR cable jacket; green
Operating temperature: -40...+70 °C
Cable length: 5 m

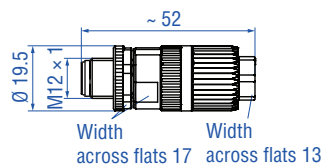

Male, straight, 4 pin
Part no.: 370 523

Housing: zinc nickel plated
Termination: isolation displacement
Wire: AWG24- AWG22
Cable Ø: 5.5...7.2 mm

Document Part Number:
551429 Revision A (EN) 05/2014



LOCATIONS

USA
MTS Systems Corporation
Sensors Division
3001 Sheldon Drive
Cary, N.C. 27513, USA
Tel. +1 919 677-0100
Fax +1 919 677-0200
info.us@mtssensors.com
www.mtssensors.com

GERMANY
MTS Sensor Technologie
GmbH & Co. KG
Auf dem Schüffel 9
58513 Lüdenscheid, Germany
Tel. +49 2351 9587-0
Fax +49 2351 56491
info.de@mtssensors.com
www.mtssensor.de

JAPAN
MTS Sensors Technology Corp.
737 Aihara-machi,
Machida-shi,
Tokyo 194-0211, Japan
Tel. +81 42 775-3838
Fax +81 42 775-5512
info.jp@mtssensors.com
www.mtssensor.co.jp

FRANCE
MTS Systems SAS
Zone EUROPARC Bâtiment EXA 16
16/18, rue Eugène Dupuis
94046 Creteil, France
Tel. +33 1 58 4390-28
Fax +33 1 58 4390-03
info.fr@mtssensors.com
www.mtssensor.com

ITALY
MTS Systems Srl.Sensor Division
Via Diaz,4
25050 Provaglio d'Iseo (BS), Italy
Tel. +39 030 988 3819
Fax +39 030 982 3359
info.it@mtssensors.com
www.mtssensor.com

CHINA
MTS Sensors
Room 504, Huajing Commercial Center,
No. 188, North Qinzhou Road
200233 Shanghai, China
Tel. +86 21 6485 5800
Fax +86 21 6495 6329
info.cn@mtssensors.com
www.mtssensors.cn

LEGAL NOTICES

MTS, Temposonics and Level Plus are registered trademarks of MTS Systems Corporation. All other trademarks are the property of their respective owners. Printed in USA. Copyright © 2014 MTS Systems Corporation. All Rights Reserved in all media.

All specifications are subject to change. Contact MTS for specifications and engineering drawings that are critical to your application. Drawings contained in this document are for reference only. Go to <http://www.mtssensors.com> for the latest product information.